



US00D959533S

(12) **United States Design Patent**  
**Nishimura**

(10) **Patent No.:** **US D959,533 S**

(45) **Date of Patent:** **\*\* Aug. 2, 2022**

(54) **VIDEO CAMERA BODY**

(71) Applicant: **CANON KABUSHIKI KAISHA,**  
Tokyo (JP)

(72) Inventor: **Kenichi Nishimura,** Tokyo (JP)

(\*\*) Term: **15 Years**

(21) Appl. No.: **35/511,688**

(22) Filed: **Mar. 29, 2021**

(80) **Hague Agreement Data**

Int. Filing Date: **Mar. 29, 2021**

Int. Reg. No.: **DM/213636**

Int. Reg. Date: **Mar. 29, 2021**

Int. Reg. Pub. Date: **Apr. 16, 2021**

(30) **Foreign Application Priority Data**

Oct. 5, 2020 (JP) ..... 2020-021287 D

(51) **LOC (13) Cl.** ..... **16-01**

(52) **U.S. Cl.**  
USPC ..... **D16/202**

(58) **Field of Classification Search**

USPC ..... D16/200, 202-206, 218, 219, 242

CPC ..... G03B 17/02; G03B 19/04; G03B 17/56;  
G03B 17/04; G03B 15/03

See application file for complete search history.

(56) **References Cited**

**U.S. PATENT DOCUMENTS**

D373,593 S \* 9/1996 Hiroko ..... D16/205

D442,982 S \* 5/2001 Adachi ..... D16/203

D472,913 S *	4/2003	Rupe	.....	D16/202
D480,741 S *	10/2003	Berger	.....	D16/202
D742,953 S *	11/2015	Li	.....	D16/202
D743,472 S *	11/2015	Tanifuji	.....	D16/203
D754,230 S *	4/2016	Mori	.....	D16/218
D764,559 S *	8/2016	Luo	.....	D16/202
D773,547 S *	12/2016	Lee	.....	D16/218
D874,531 S *	2/2020	Chen	.....	D16/202
D893,576 S *	8/2020	Kyte	.....	D16/202
D894,991 S *	9/2020	Park	.....	D16/202
D906,396 S *	12/2020	Schaarschmidt	.....	D16/202
D908,154 S	1/2021	Nishimura		
D908,155 S	1/2021	Nishimura		
D911,414 S *	2/2021	Zheng	.....	D16/202
D917,603 S *	4/2021	O'Connor	.....	D16/218
2020/0076993 A1 *	3/2020	Shingai	.....	H04N 5/2252

\* cited by examiner

*Primary Examiner* — Holly E Thurman

(57) **CLAIM**

The ornamental design for a video camera body, as shown and described.

**DESCRIPTION**

1. Video camera body

1.1: Front

1.2 : Back

1.3: Top

1.4 : Bottom

1.5 : Left

1.6 : Right

1.7 : Perspective

The broken lines in the drawings illustrate portions of the video camera body which form no part of the claimed design.

**1 Claim, 7 Drawing Sheets**

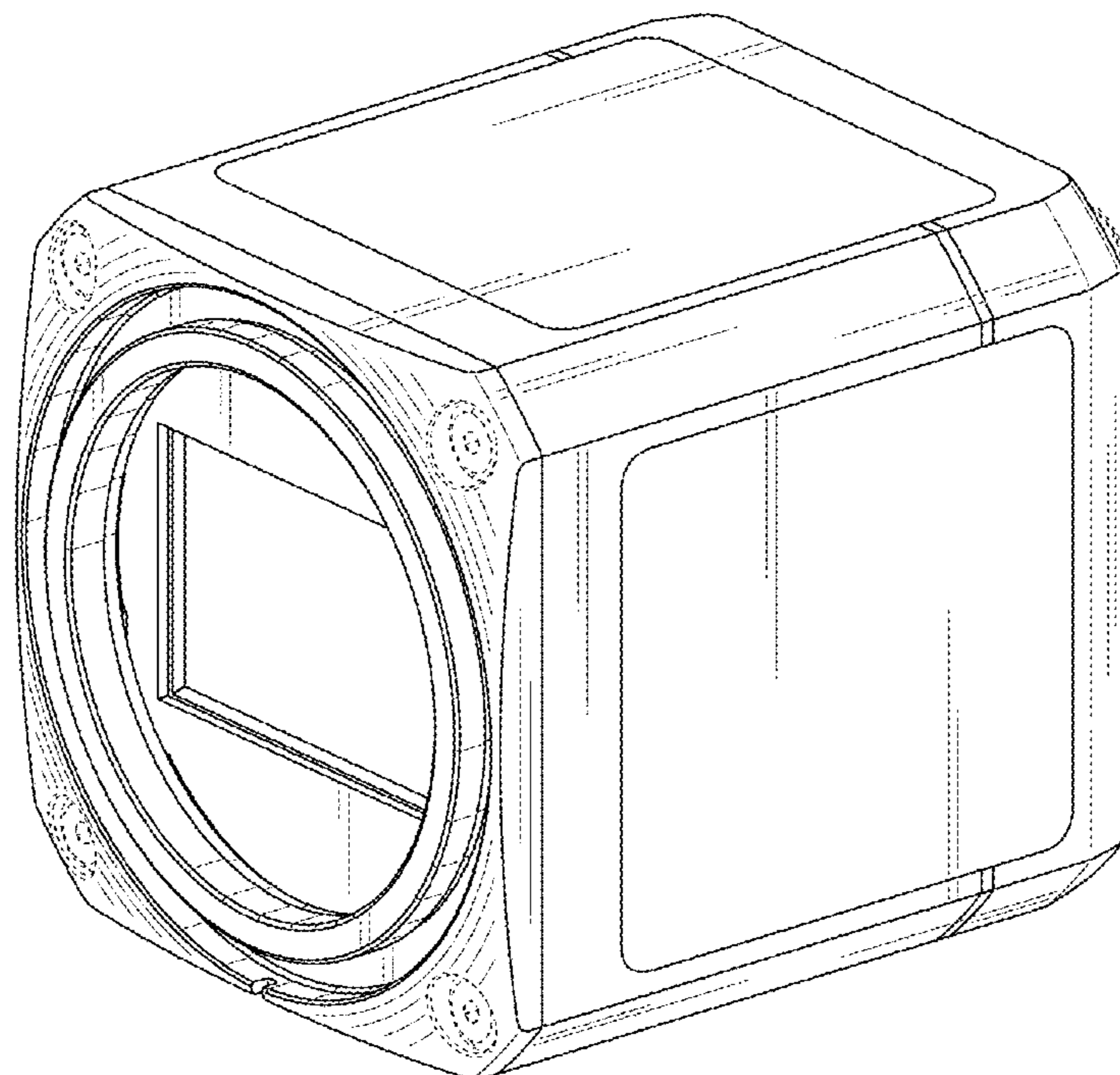

1.1

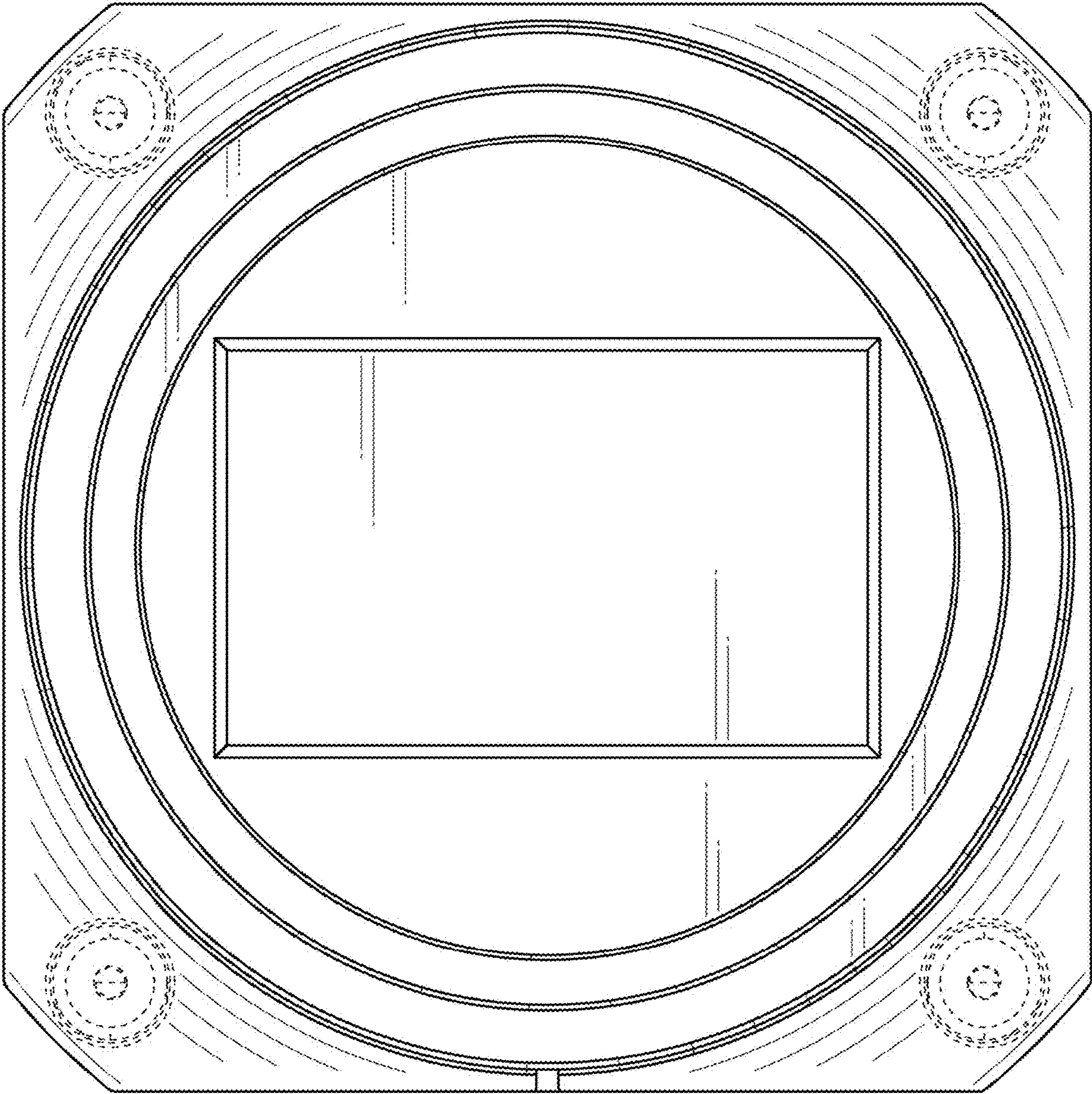



1.2

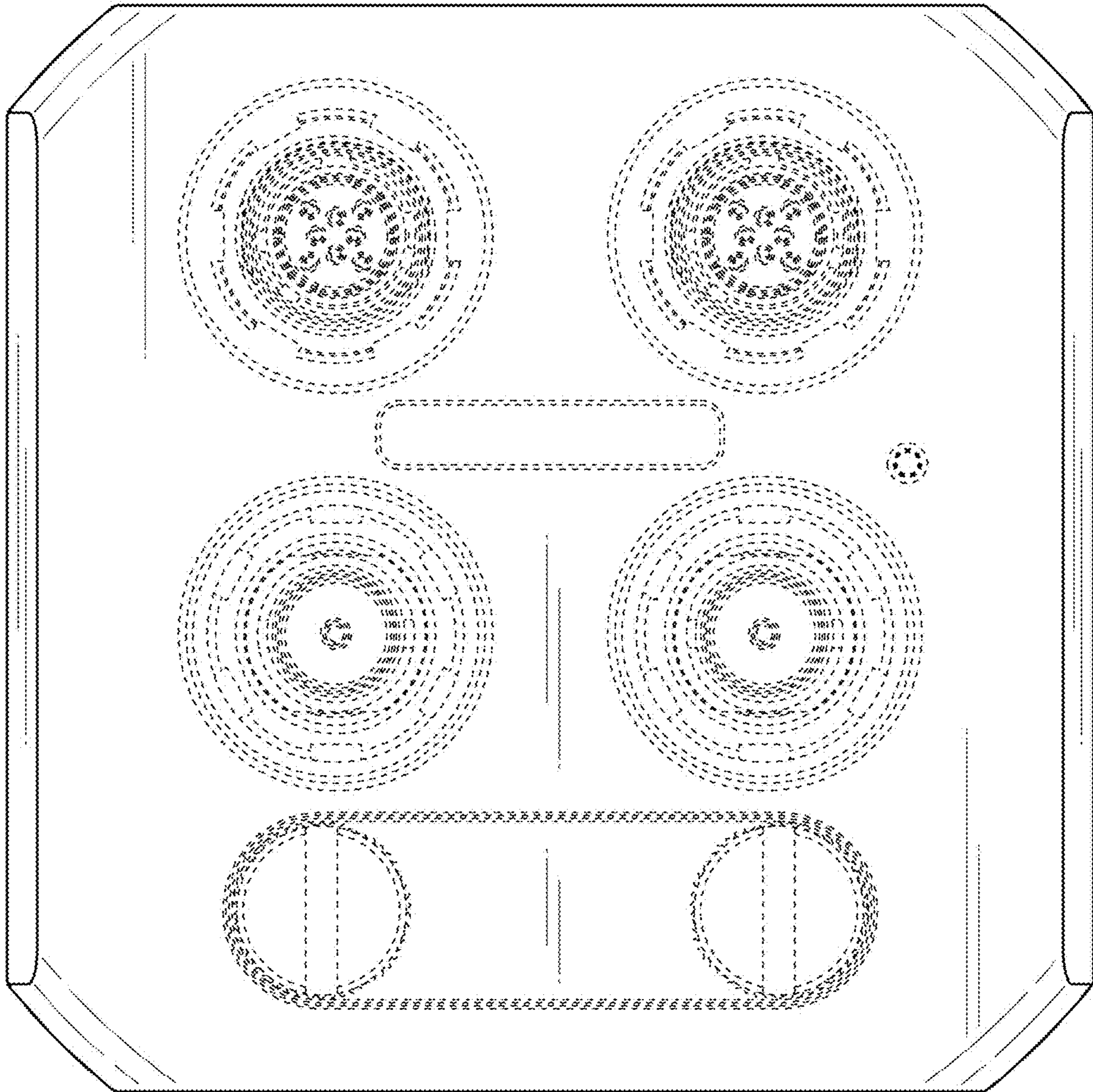

1.3

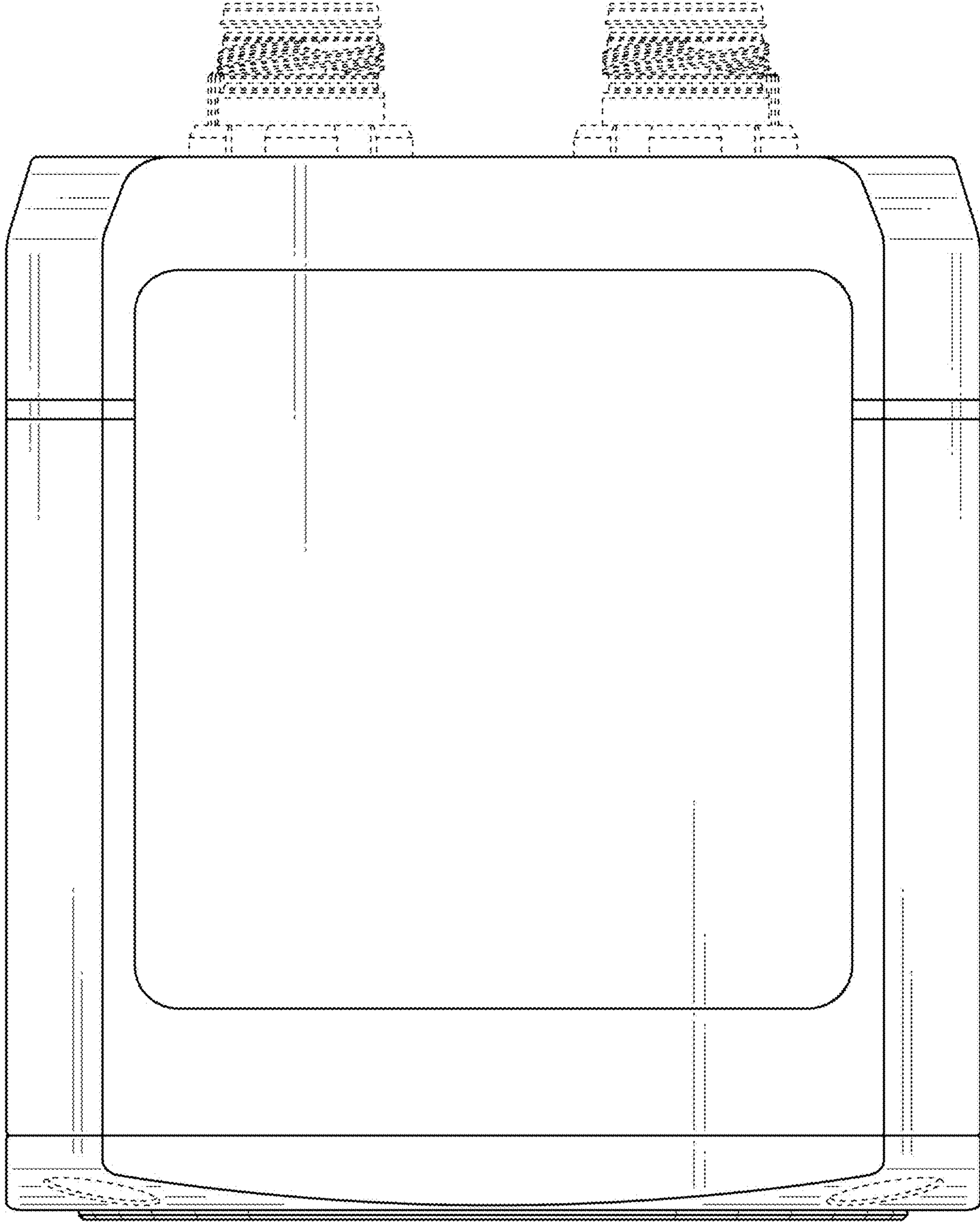

1.4

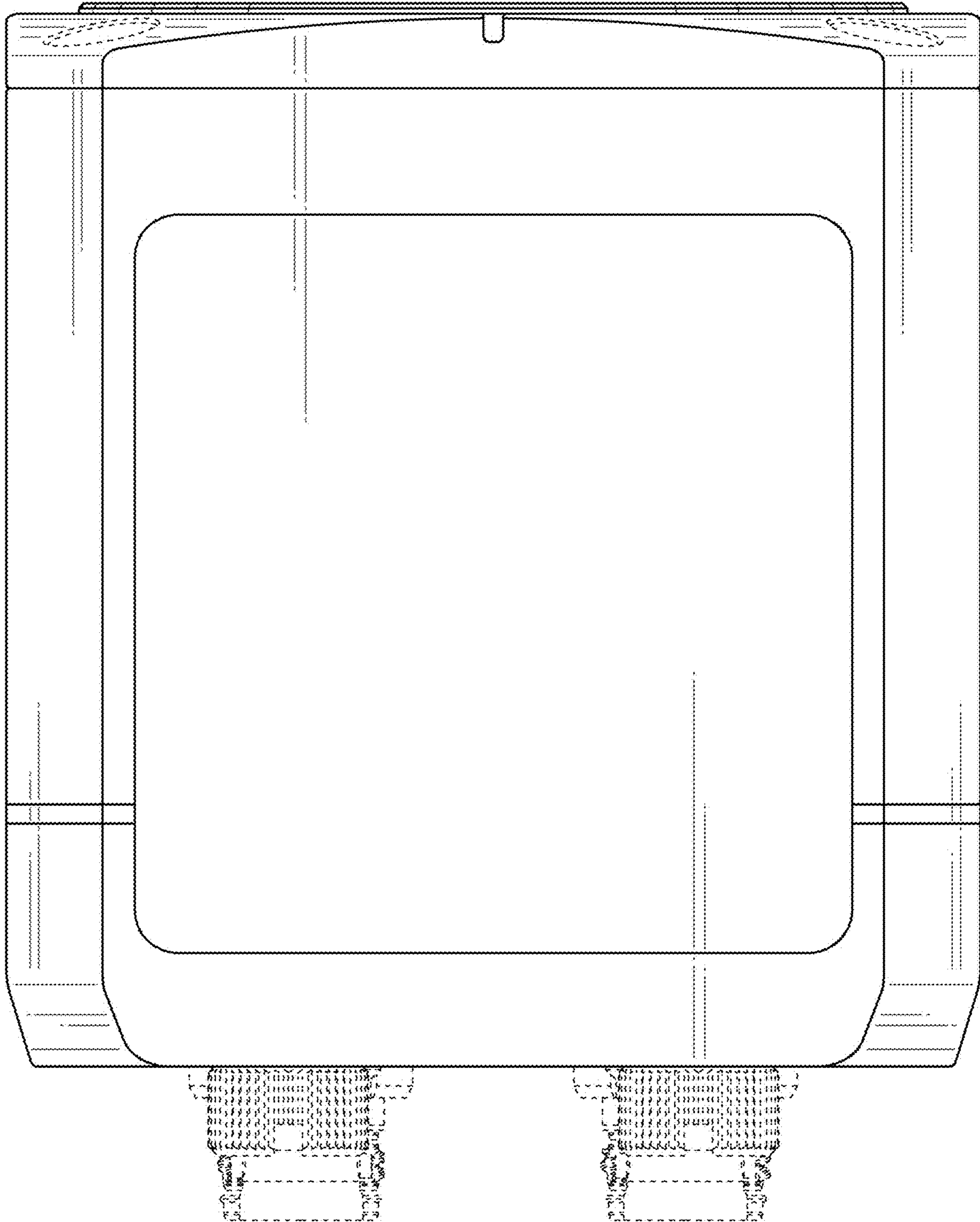



1.5

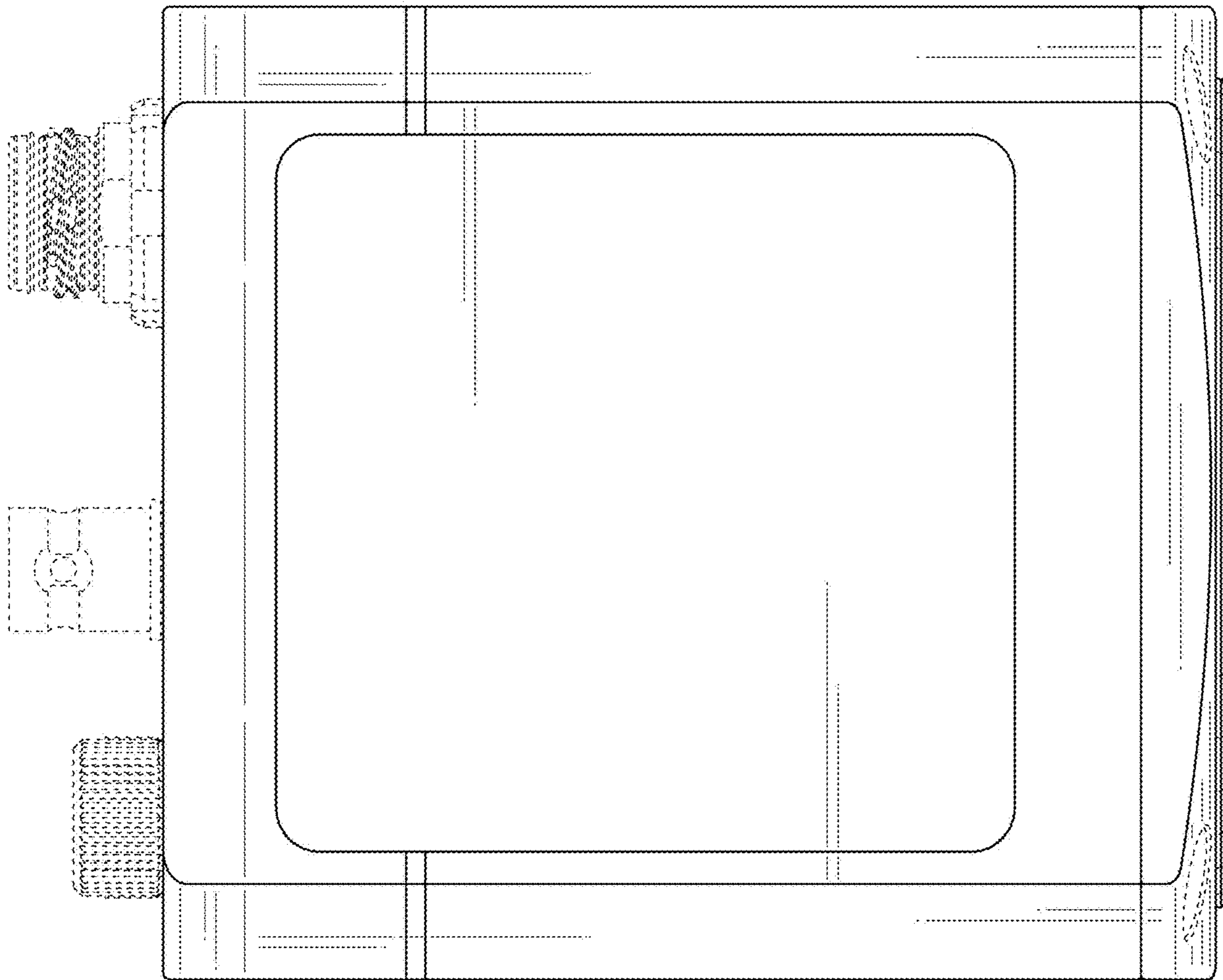

1.6

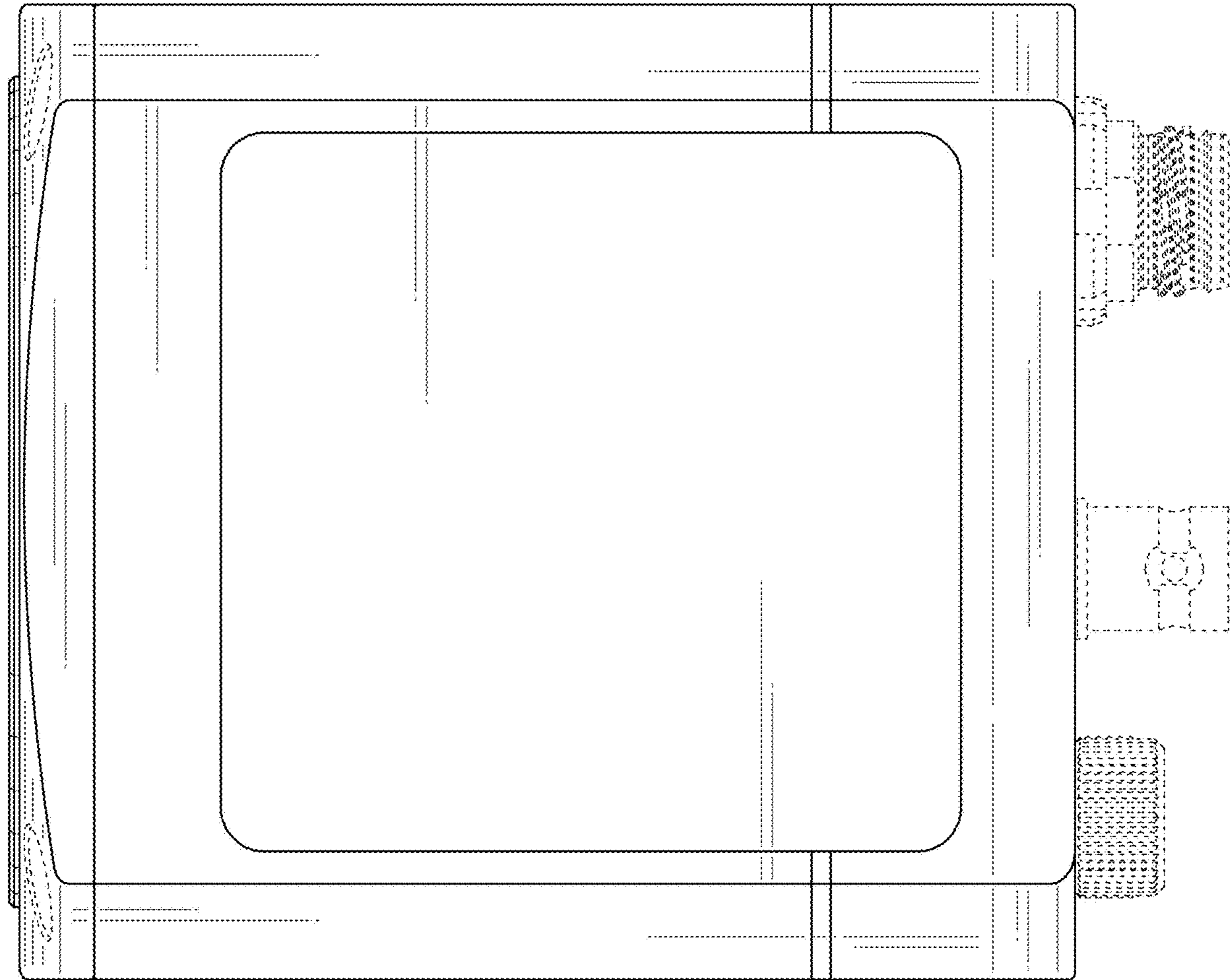

1.7

