



US00D959407S

(12) **United States Design Patent** (10) **Patent No.:** **US D959,407 S**
Pupecki et al. (45) **Date of Patent:** **** Aug. 2, 2022**

(54) **LOUDSPEAKER**

2400/00; H04R 2400/07; H04R 2499/11;
H04R 2499/13; H04R 2499/15; H04S
3/00; H04S 7/30

(71) Applicant: **Bose Corporation**, Framingham, MA
(US)

See application file for complete search history.

(72) Inventors: **Jason R. Pupecki**, Worcester, MA
(US); **Jonathan Salerno**, Marlborough,
MA (US); **Alexander Decastro**
Calachan, Cambridge, MA (US); **Colin**
Taylor Mosgrove, Needham, MA (US);
Eric Douglas Curtiss, East Boston,
MA (US); **Emily L. Ballantyne**,
Watertown, MA (US); **Evan Scott**
Rakusin, North Reading, MA (US);
Brenton Harry Eva, Fayette, ME (US);
David Kaphammer, Westborough, MA
(US)

(56) **References Cited**

U.S. PATENT DOCUMENTS

D836,606 S * 12/2018 Kangasmaa D14/216
D849,718 S * 5/2019 Park D14/216
D868,739 S * 12/2019 Ryu D14/216
D873,244 S * 1/2020 Lee D14/216

(Continued)

OTHER PUBLICATIONS

Ember Temperature Control Ceramic Mug, White—CM17, retrieved
from the internet May 6, 2019, https://www.amazon.com/Ember-Temperature-Control-Ceramic-Mug/dp/B0773WG6NK/ref=asc_df_B0773WG6NK/?tag=hyprod-20&linkCode=df0&hvadid=234671296470&hvpos=lo1&hvnetw=g&hvrnd=17832791369615695916&hvpone=&hvptwo=&hvqmt=&hvdev=c&hvdvcmdl=&hvlocint=&hvlocphy=9001841&hvtargid=pla-390573331153&psc=1.

(Continued)

Primary Examiner — Keli L Hill

(74) *Attorney, Agent, or Firm* — Bose Corporation

(73) Assignee: **Bose Corporation**, Framingham, MA
(US)

(**) Term: **15 Years**

(21) Appl. No.: **29/674,506**

(22) Filed: **Dec. 21, 2018**

(51) **LOC (13) Cl.** **14-01**

(52) **U.S. Cl.**
USPC **D14/216**

(58) **Field of Classification Search**
USPC D14/167, 168, 170–172, 188, 194–197,
D14/203.1–203.8, 204, 209.1, 210–216,
D14/219, 221, 222, 224, 239, 496
CPC B60R 11/0217; G06F 1/1688; G10K 9/22;
G10K 11/004; H03F 1/327; H04M 1/03;
H04M 1/035; H04N 5/642; H04N
21/4852; H04R 1/02; H04R 1/06; H04R
1/021; H04R 1/025; H04R 1/026; H04R
1/028; H04R 1/105; H04R 1/323; H04R
1/403; H04R 1/2803; H04R 1/2834;
H04R 5/02; H04R 7/20; H04R 9/06;
H04R 9/025; H04R 2201/021; H04R

(57) **CLAIM**

The ornamental design for a loudspeaker, substantially as
shown and described.

DESCRIPTION

FIG. 1 is a top, front, right side perspective view of a
loudspeaker;
FIG. 2 is a back, bottom, left side perspective view thereof;
FIG. 3 is a front view thereof;
FIG. 4 is a back view thereof;
FIG. 5 is a left side view thereof;
FIG. 6 is a right side view thereof;
FIG. 7 is a top plan view thereof; and,
FIG. 8 is a bottom view thereof.

(Continued)

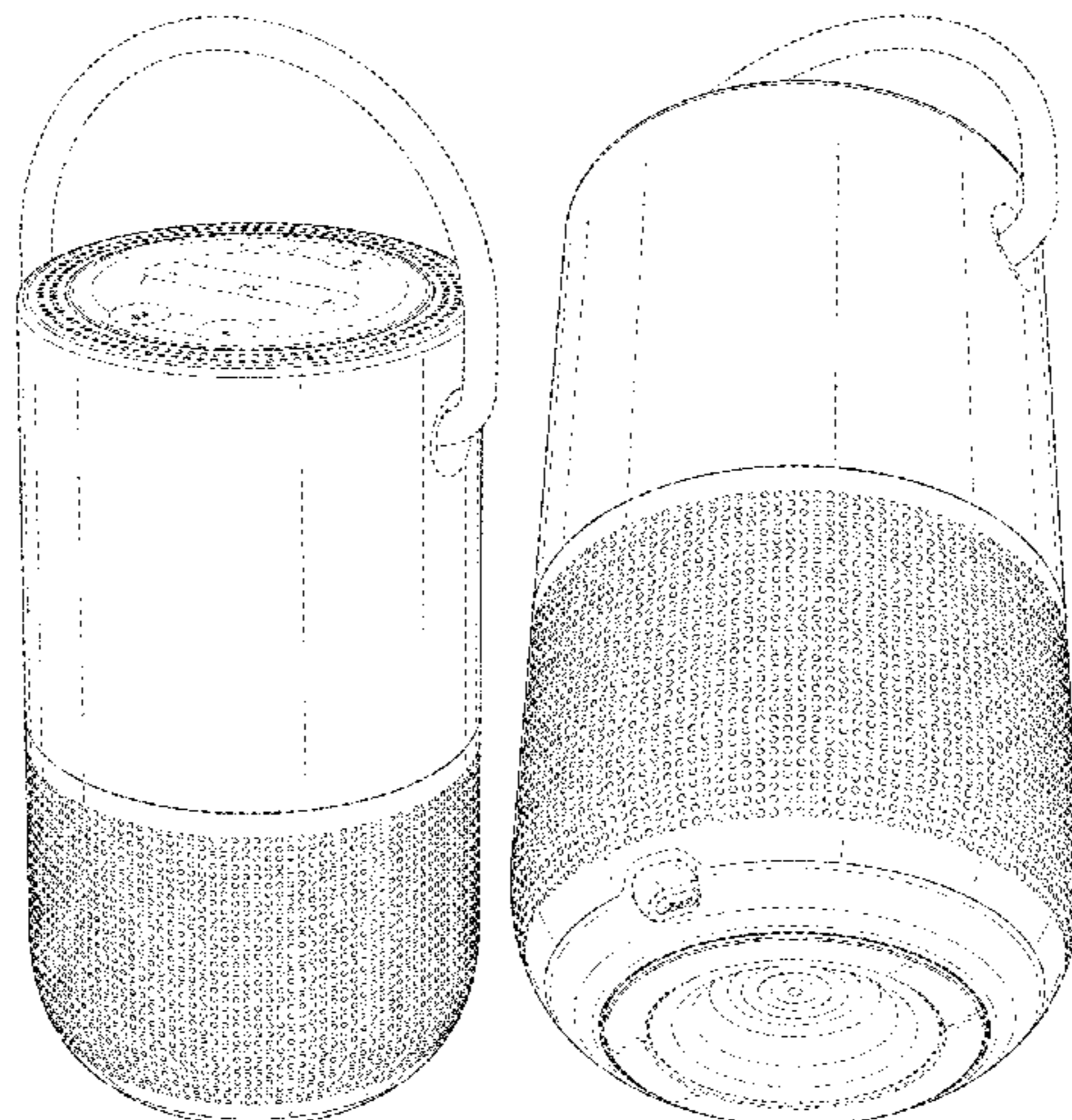

The broken lines shown are included for the purpose of illustrating portions of the loudspeaker that form no part of the claim.

D935,444 S * 11/2021 Xu D14/215
2020/0221198 A1 * 7/2020 Pupecki H05K 1/189
2021/0160601 A1 * 5/2021 Eva H04R 1/021

1 Claim, 8 Drawing Sheets

OTHER PUBLICATIONS

(56)

References Cited

U.S. PATENT DOCUMENTS

D882,548 S * 4/2020 Guo D14/216
D896,780 S * 9/2020 Pupecki D14/204
D905,012 S * 12/2020 Lee D14/216
D905,049 S * 12/2020 Lu D14/314
D906,290 S * 12/2020 Kang D14/216
D908,660 S * 1/2021 Xi D14/204
D927,550 S * 8/2021 Mangum D14/496
D931,830 S * 9/2021 He D14/204

Amazon Tap—Alexa-Enabled Portable Bluetooth Speaker, retrieved from the internet May 6, 2019, https://www.amazon.com/Amazon-Tap-Portable-Wireless-Bluetooth-Speaker-with-WiFi-Alexa/dp/B01BH83OOM/ref=sr_1_1?keywords=amazon+tap&qid=1557156741&s=gateway&sr=8-1.

Ultimate Ears MEGABOOM 3 Portable Bluetooth Wireless Speaker, Night Black with Free Power Up Charging Dock, retrieved from the internet May 6, 2019, https://www.amazon.com/Ultimate-Ears-MEGABOOM-Bluetooth-Waterproof/dp/B07N3FVNRX/ref=sr_1_2?hvadid=78615134280247&hvbm=bp&hvdev=c&hvqmt=p&keywords=ue%2Bboom%2Bmegaboom&qid=1557156910&s=gateway&sr=8-2&th=1.

* cited by examiner

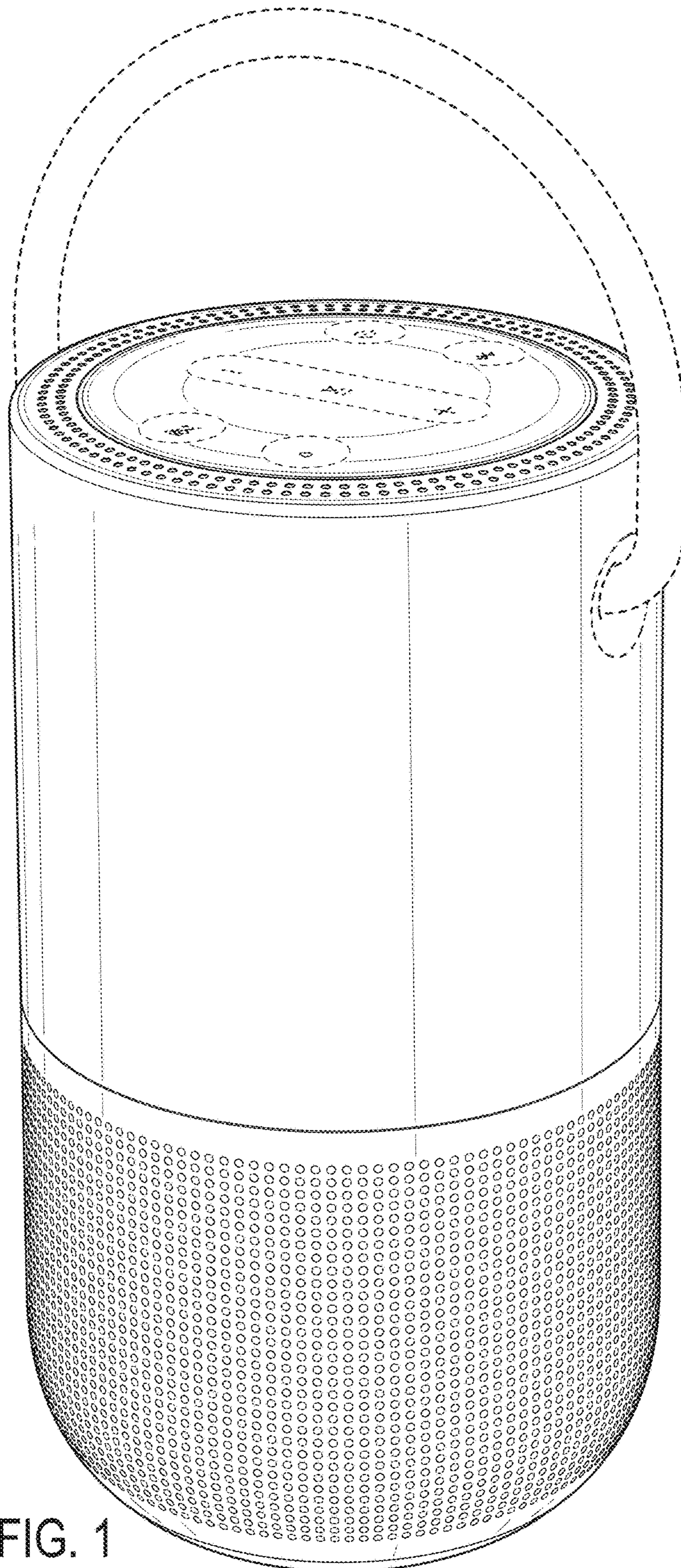

FIG. 1

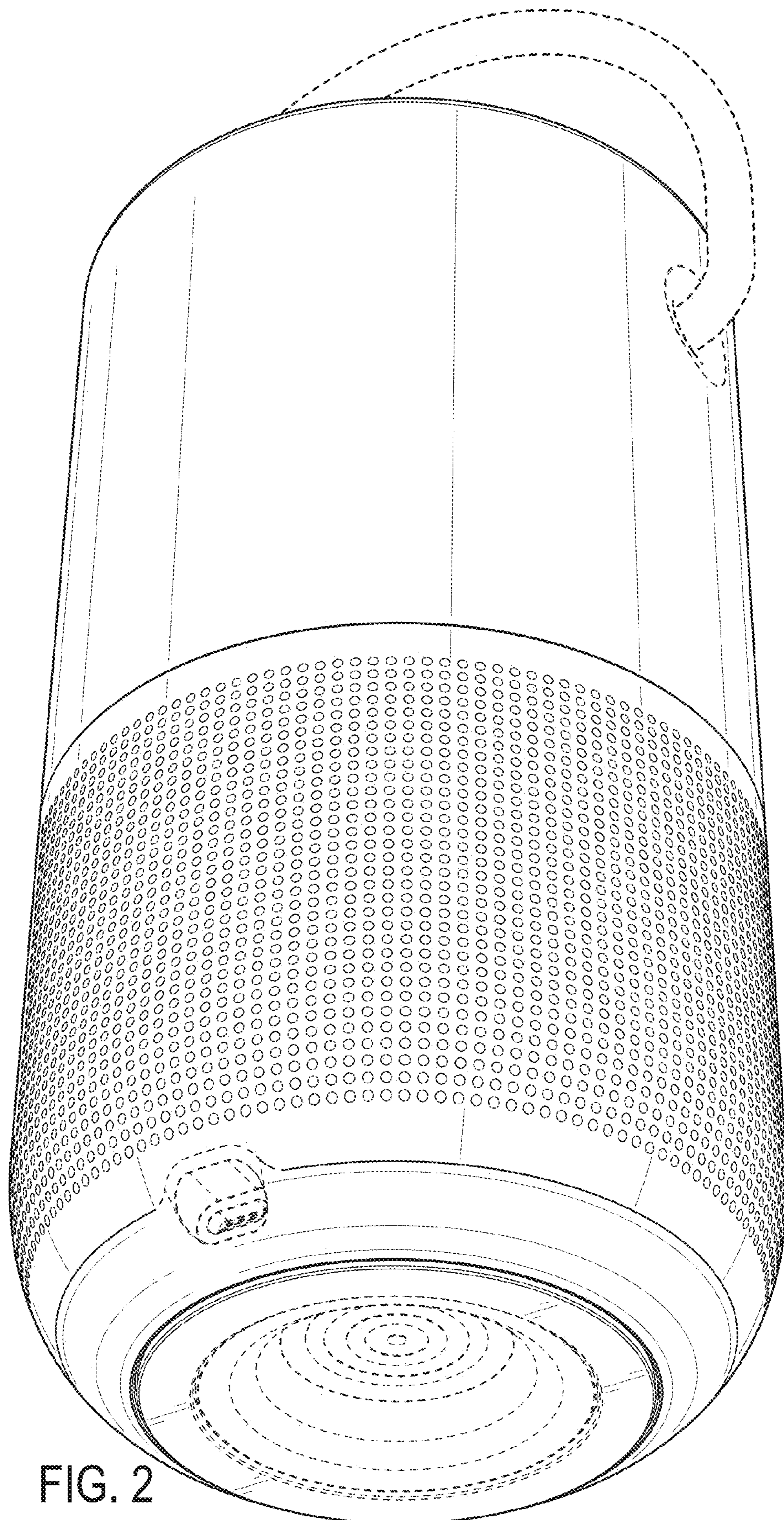

FIG. 2

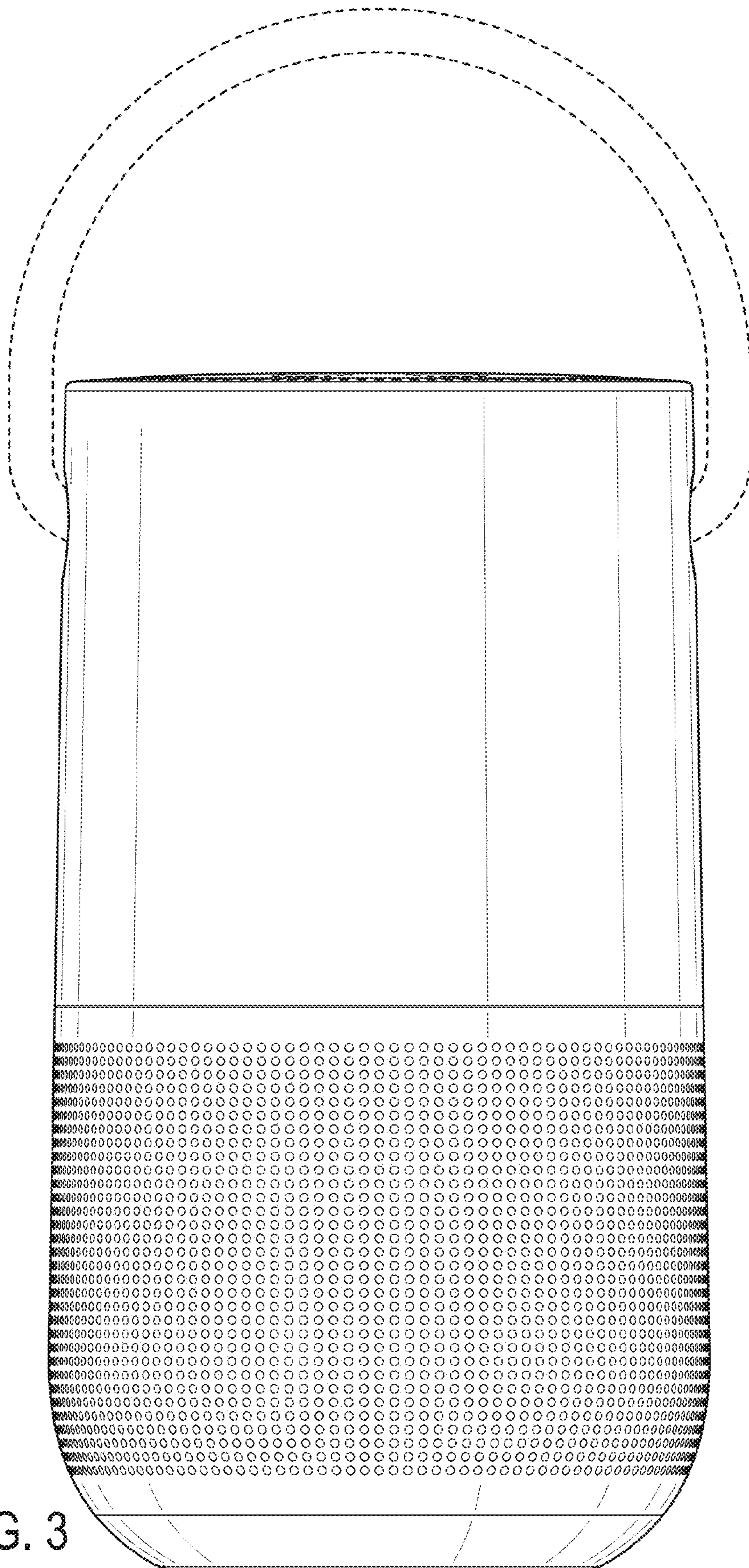

FIG. 3

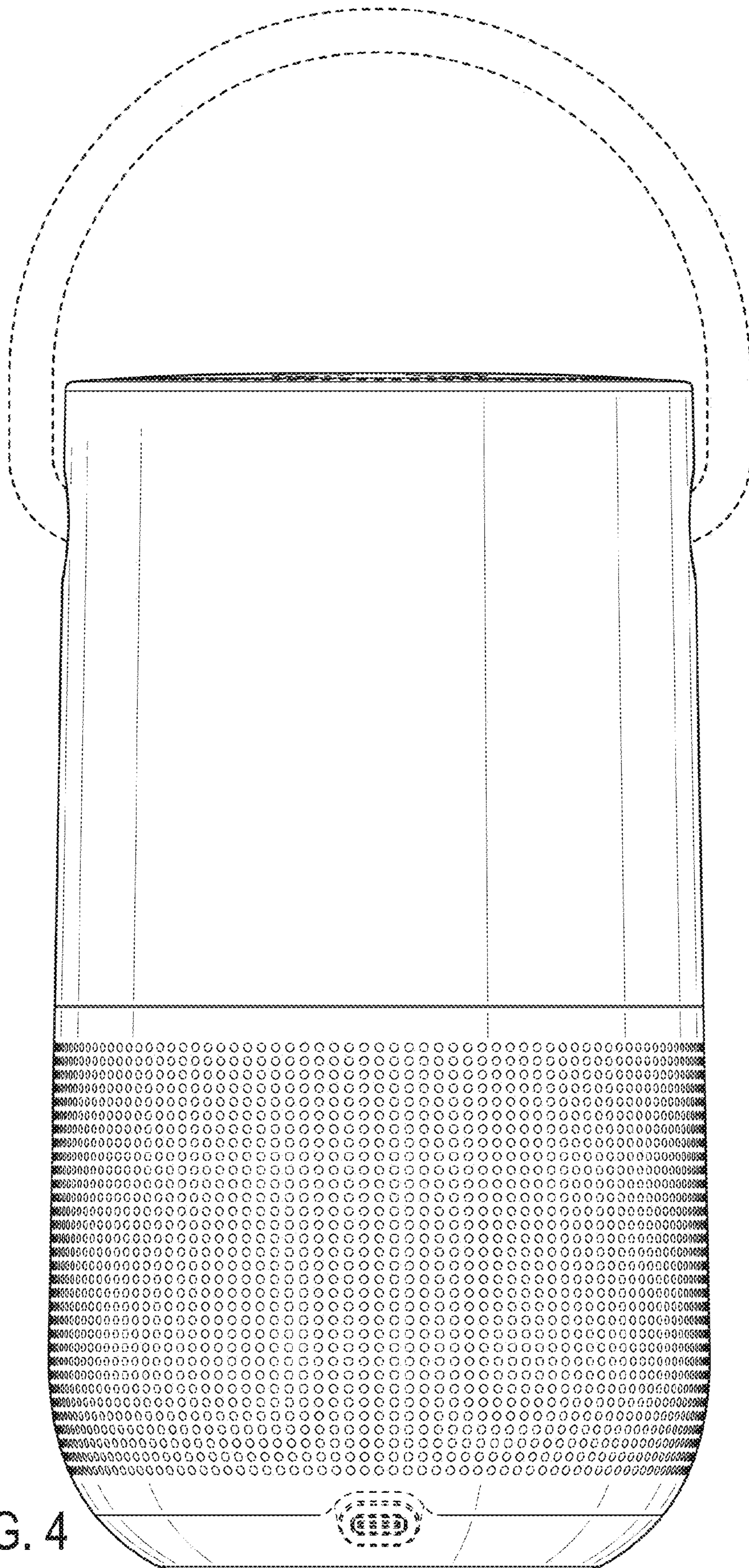

FIG. 4

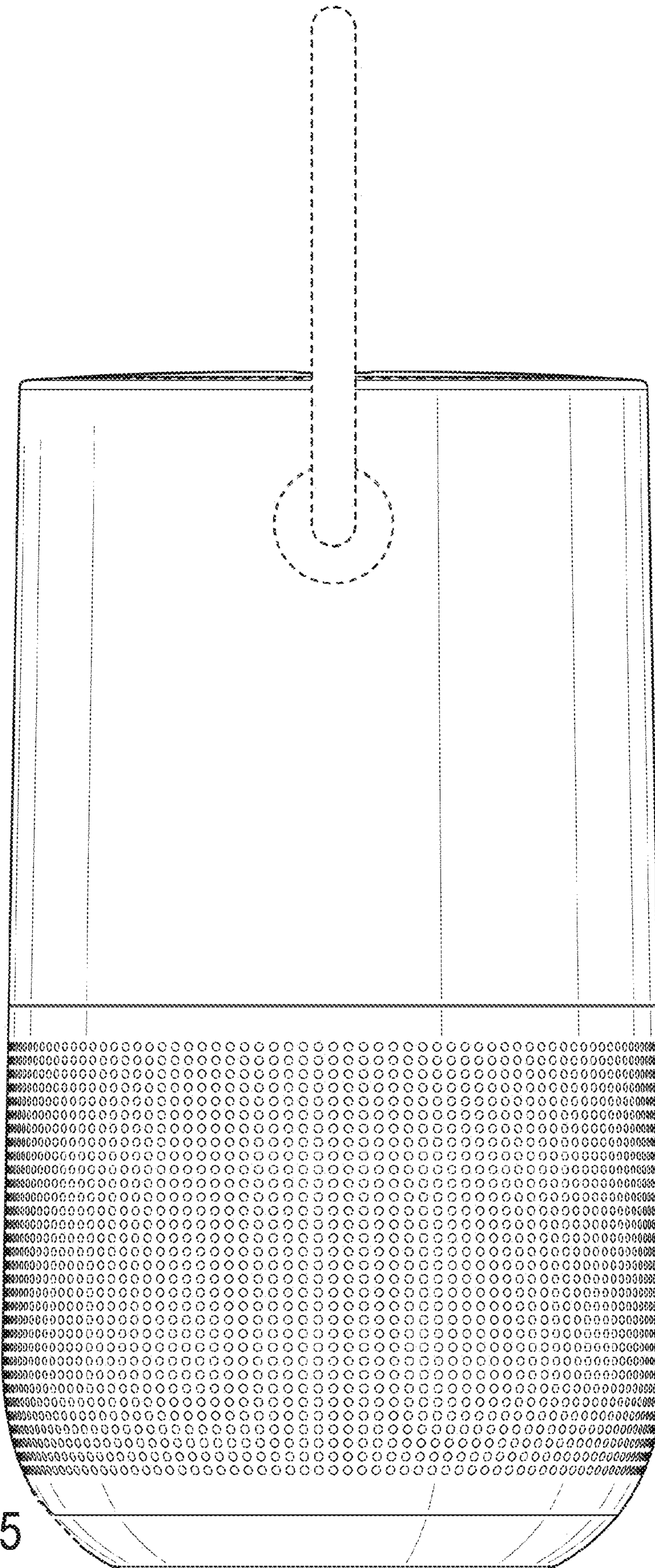

FIG. 5

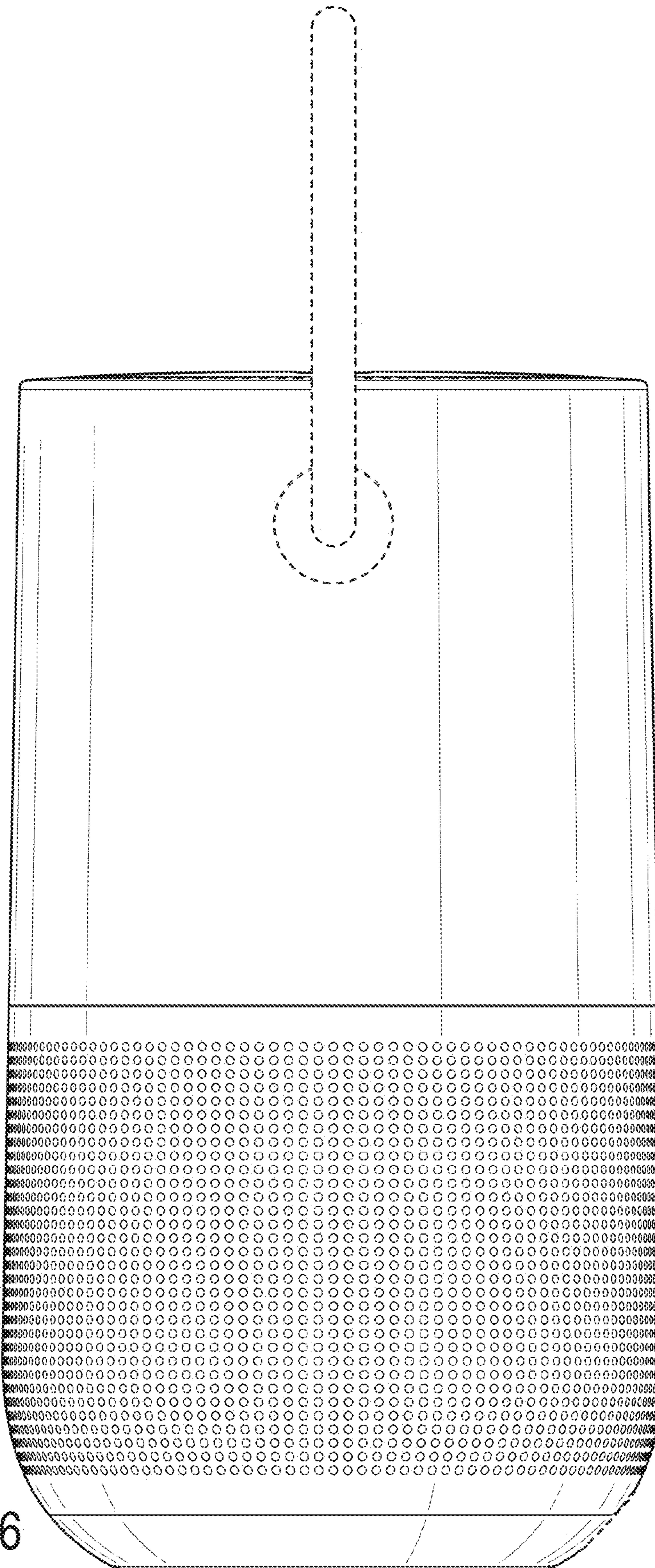

FIG. 6

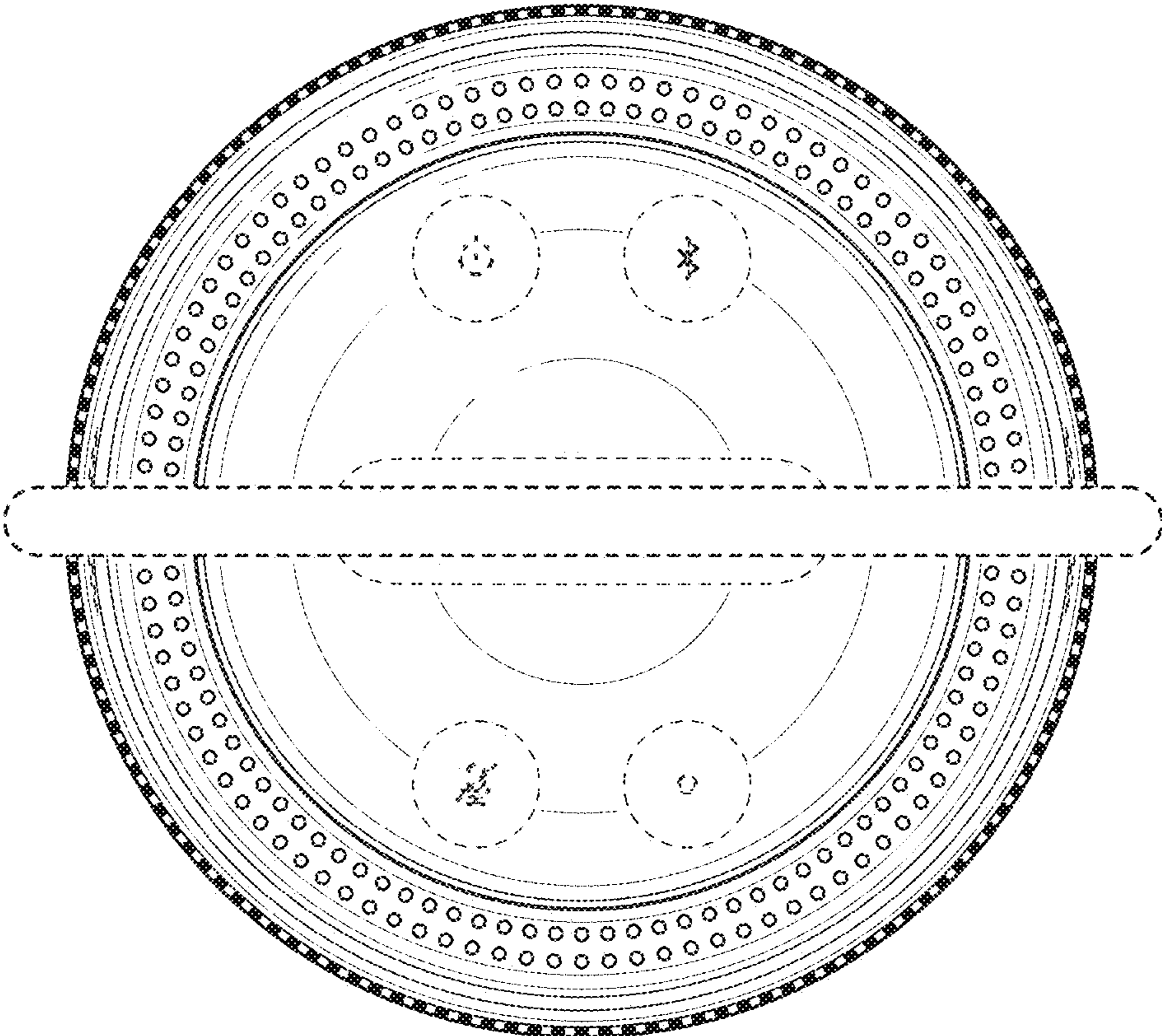

FIG. 7

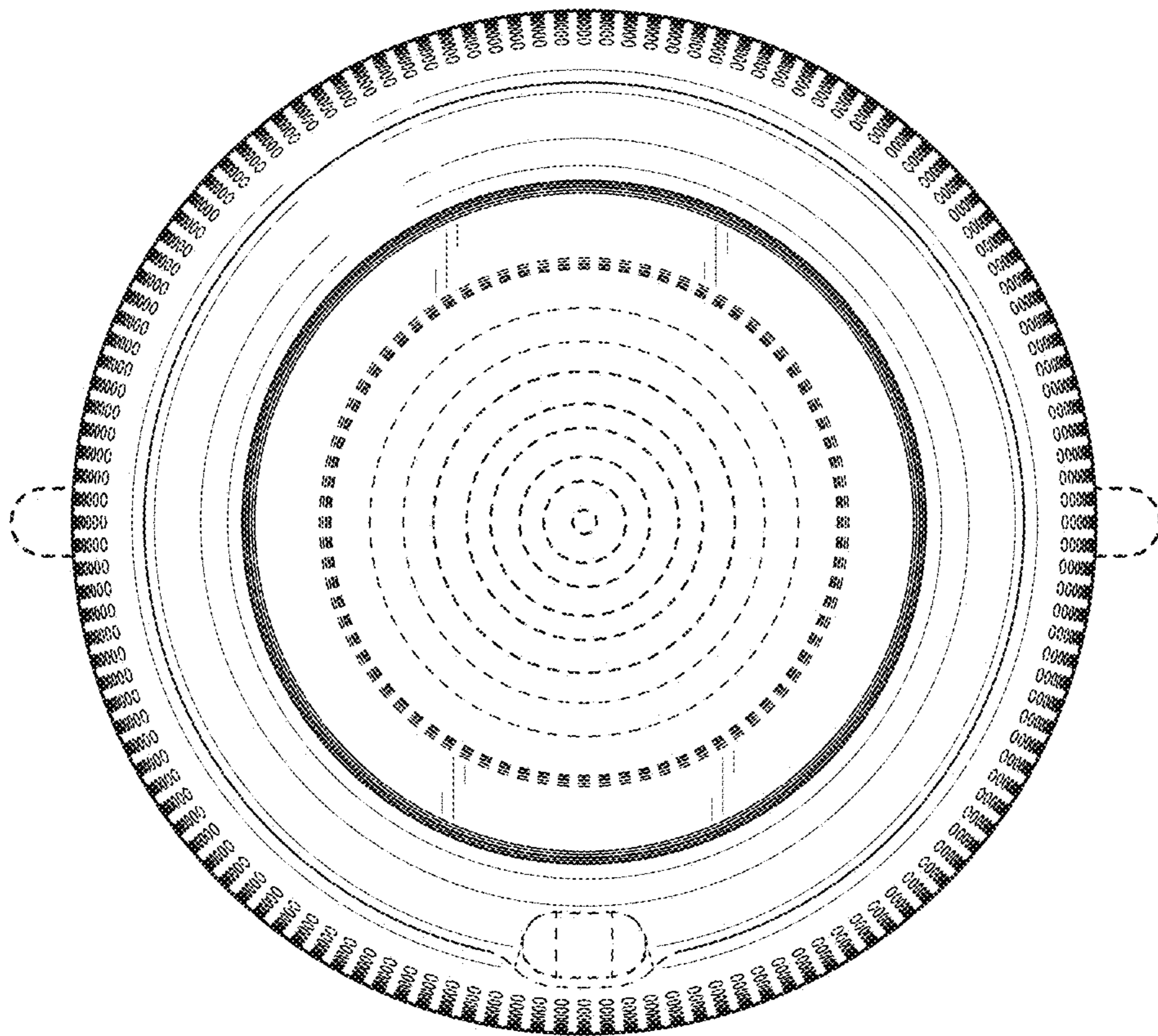

FIG. 8