



US00D959331S

(12) **United States Design Patent** (10) **Patent No.:** **US D959,331 S**
Yao (45) **Date of Patent:** **** Aug. 2, 2022**

(54) **CAR BODY**

(71) Applicant: **Human Horizons (Jiangsu) Technology Co., Ltd., Jiangsu (CN)**
(72) Inventor: **Yucheng Yao, Yancheng (CN)**
(73) Assignee: **Human Horizons (Jiangsu) Technology Co., Ltd., Yancheng (CN)**

(**) Term: **15 Years**
(21) Appl. No.: **29/788,104**
(22) Filed: **Mar. 16, 2021**

Related U.S. Application Data

(62) Division of application No. 29/652,031, filed on Dec. 31, 2019, now Pat. No. Des. 920,842.

(30) **Foreign Application Priority Data**

Jul. 3, 2019 (CN) 201930350828.3
(51) **LOC (13) Cl.** **12-08**
(52) **U.S. Cl.**
USPC **D12/91**
(58) **Field of Classification Search**
USPC D12/86, 90-92, 164; D21/424, 433, 434,
D21/533; 296/181.1-181.5, 183.1
CPC B62D 25/00; B62D 25/06; B62D 33/00;
B62D 35/00
See application file for complete search history.

(56) **References Cited**

U.S. PATENT DOCUMENTS

D864,025 S	10/2019	Tomasson et al.
D872,650 S	1/2020	Tomasson et al.
D881,755 S	4/2020	Tomasson et al.
D894,047 S	8/2020	Tomasson et al.
D912,577 S	3/2021	Fontaeus et al.
D914,544 S	3/2021	Sheffield et al.
D920,842 S *	3/2021	Sheffield D12/91

* cited by examiner

Primary Examiner — Melody N Brown

(74) *Attorney, Agent, or Firm* — Oppedahl Patent Law Firm LLC

(57) **CLAIM**

The ornamental design for a car body, as shown and described.

DESCRIPTION

FIG. 1 is a front elevational view of a car body showing my new design;
FIG. 2 is a rear elevational view thereof;
FIG. 3 is a left side elevational view thereof;
FIG. 4 is a right side elevational view thereof;
FIG. 5 is a top plan view thereof; and,
FIG. 6 is a right, front perspective view thereof.
The portions of the car body shown in broken lines are for environmental and illustrative purposes and form no part of the claimed design.

1 Claim, 6 Drawing Sheets

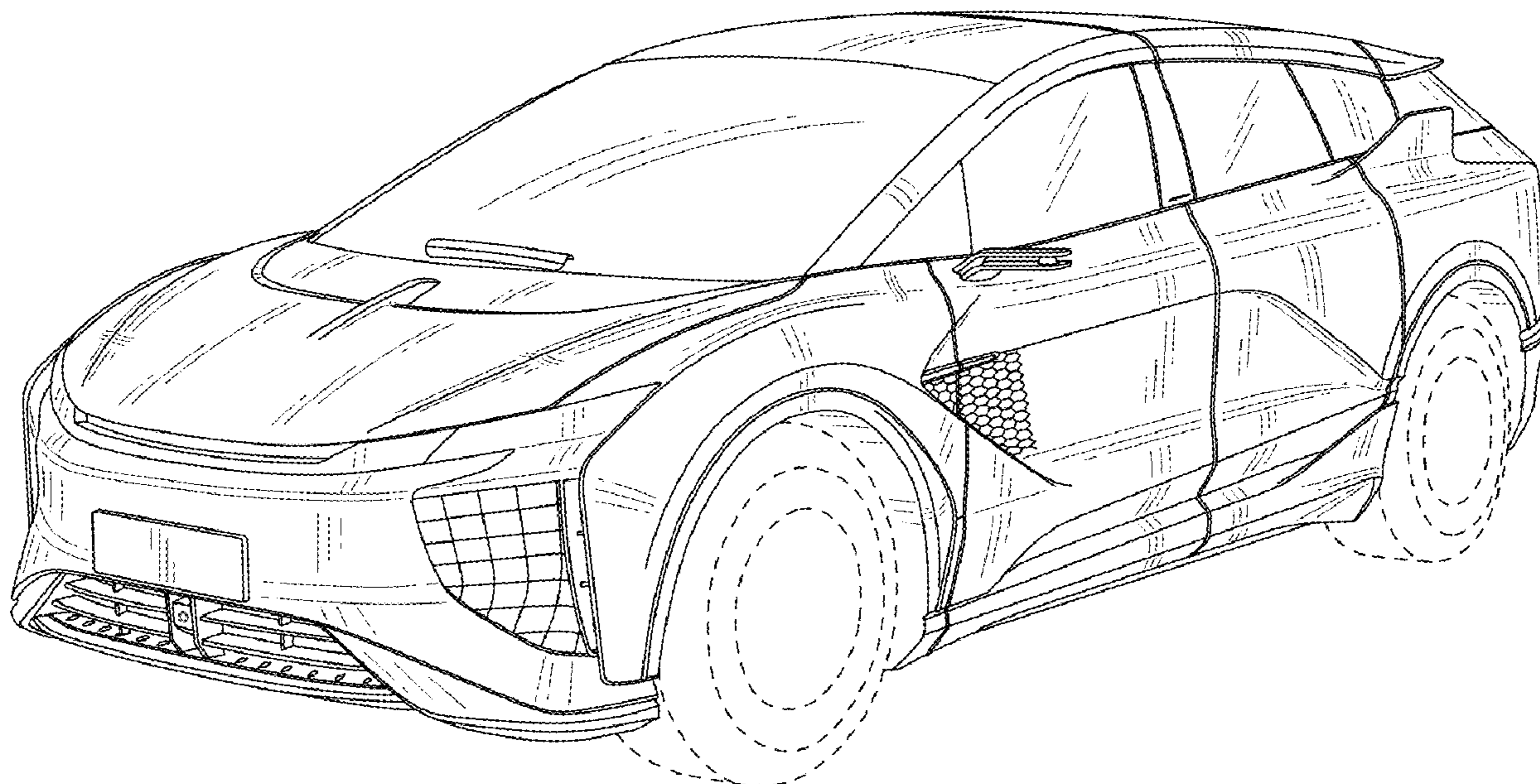

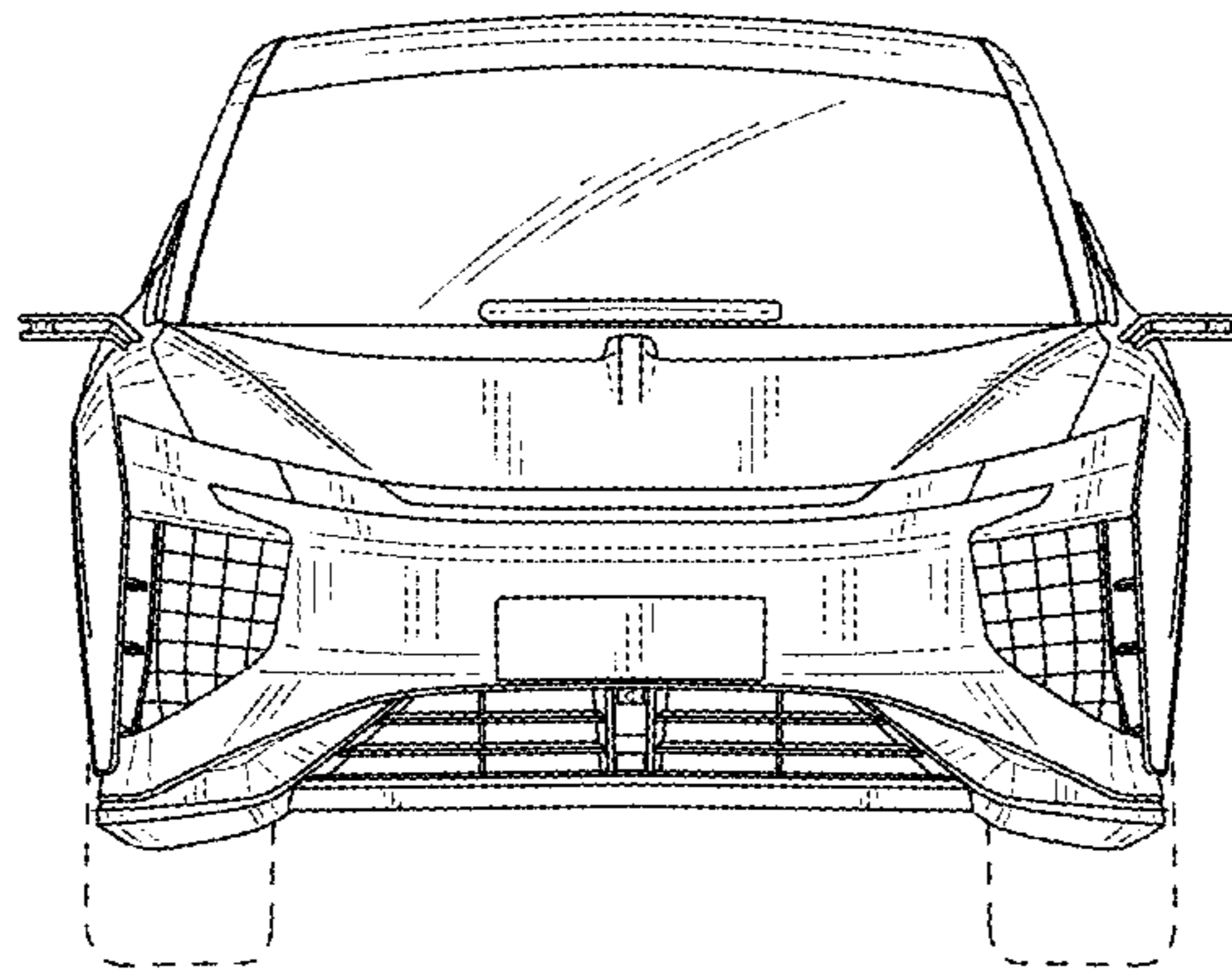

FIG. 1

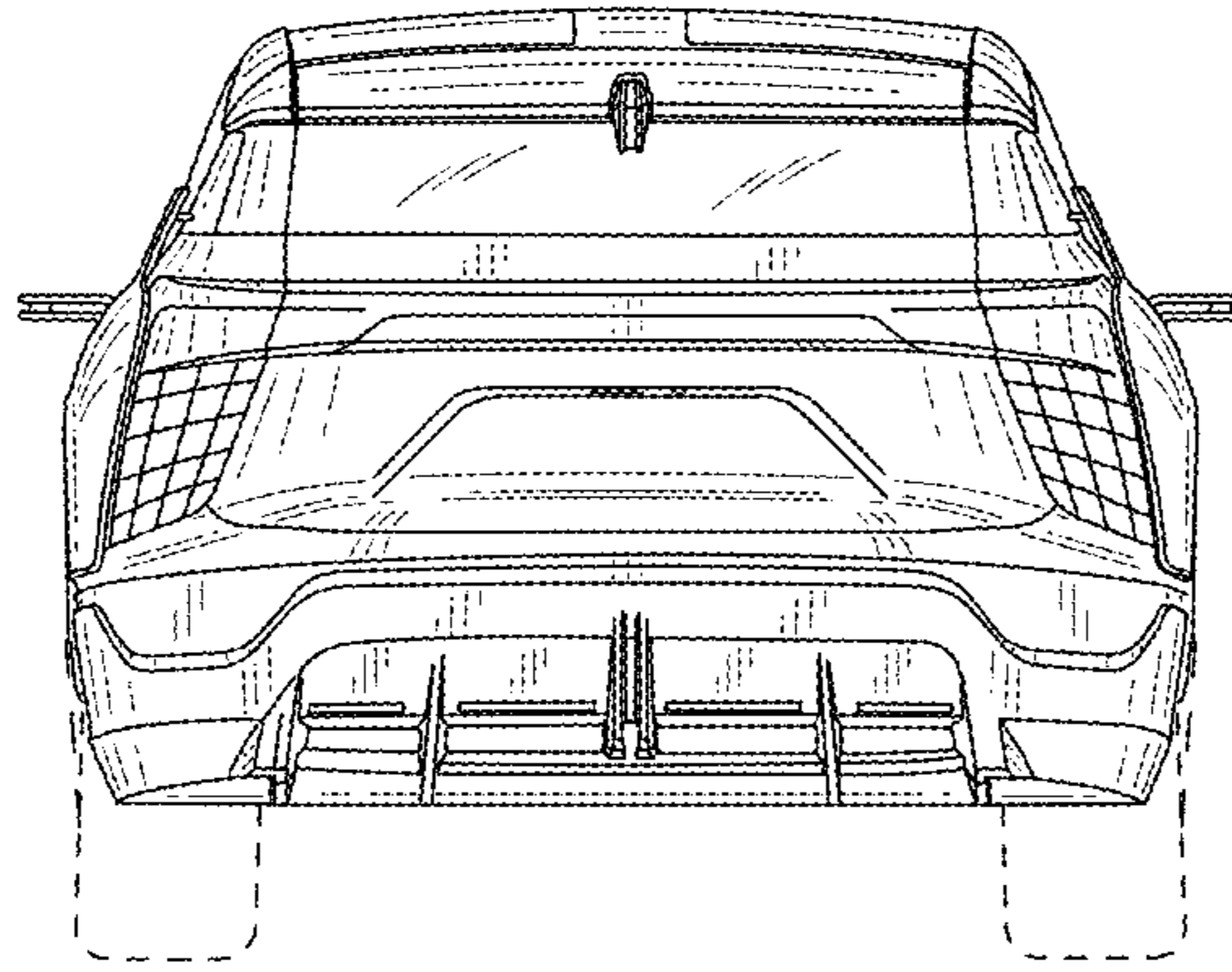

FIG. 2

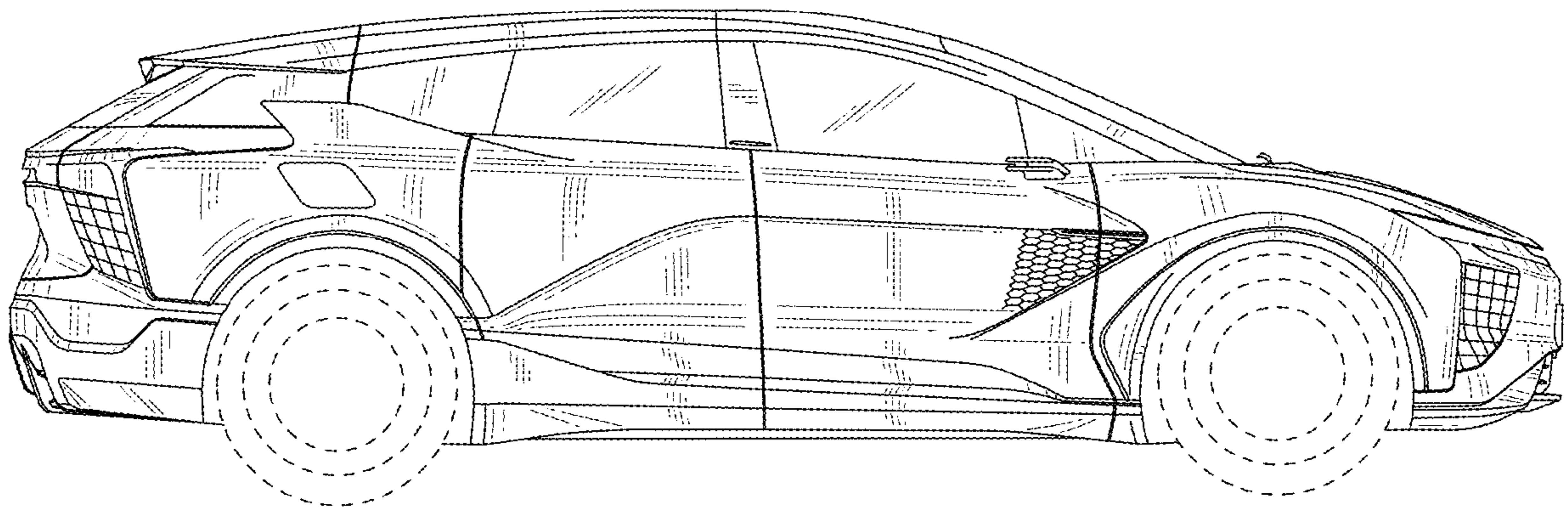

FIG. 3

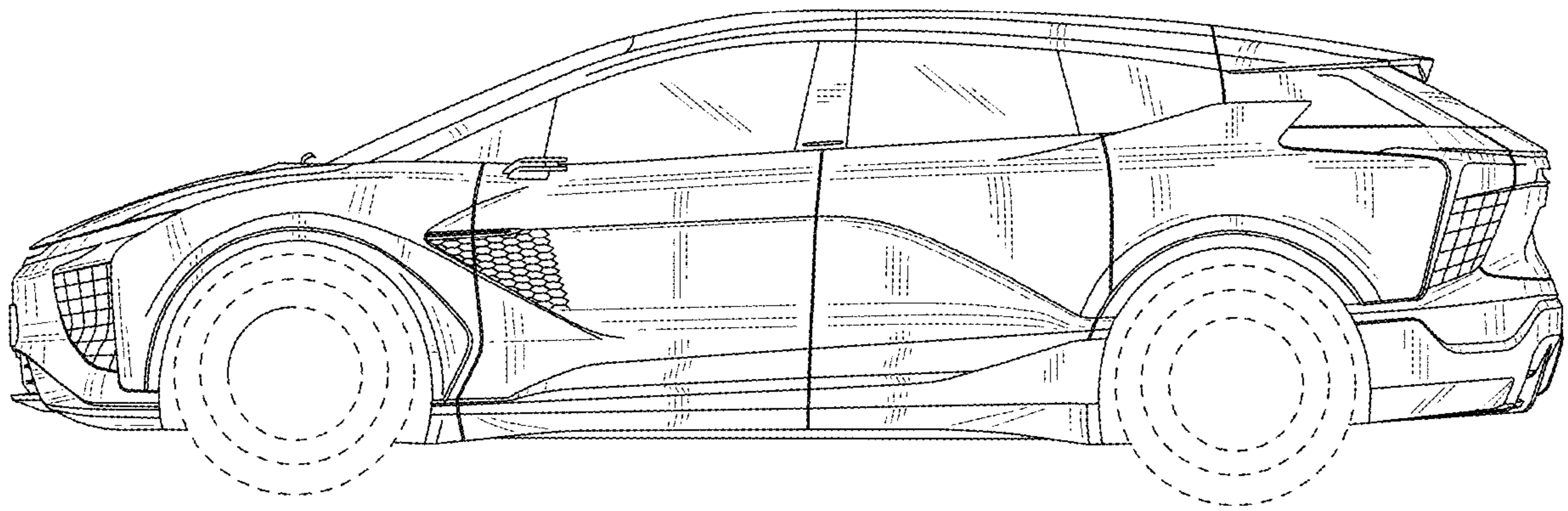

FIG. 4

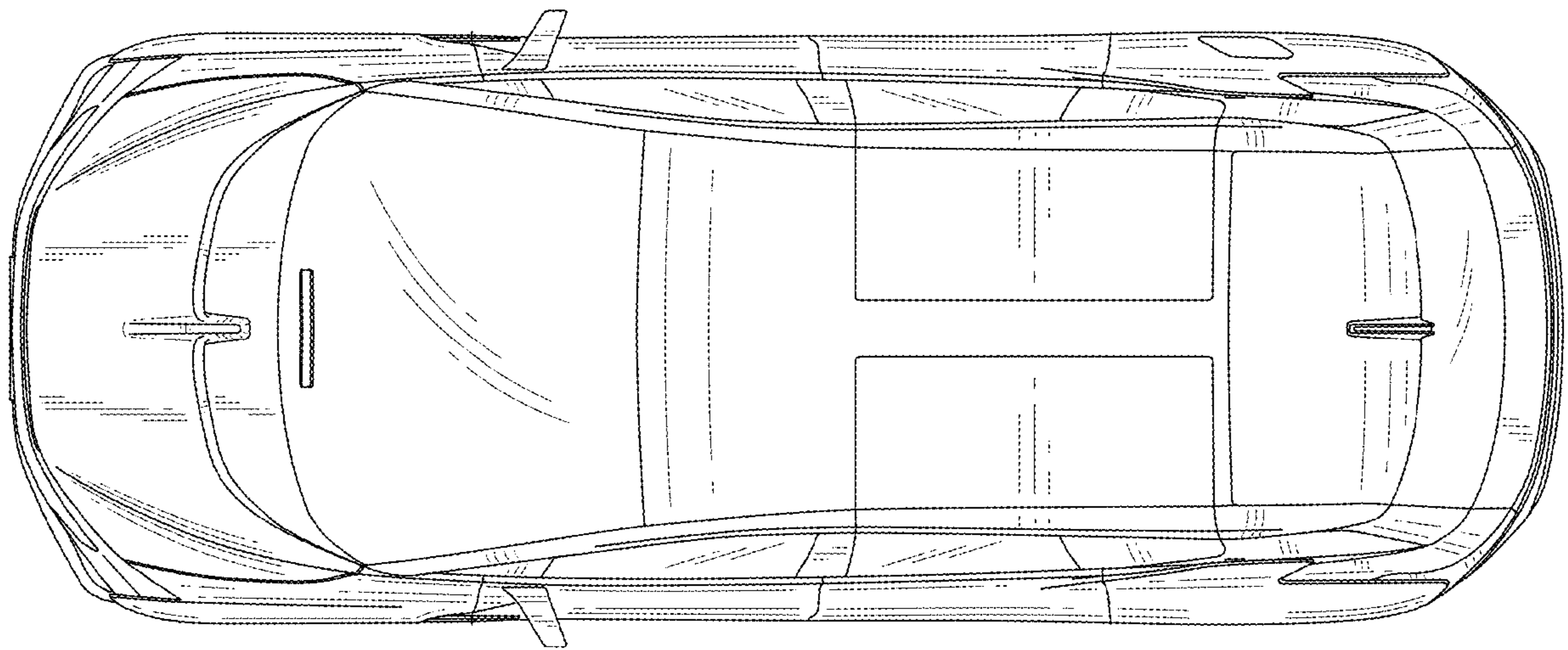

FIG. 5

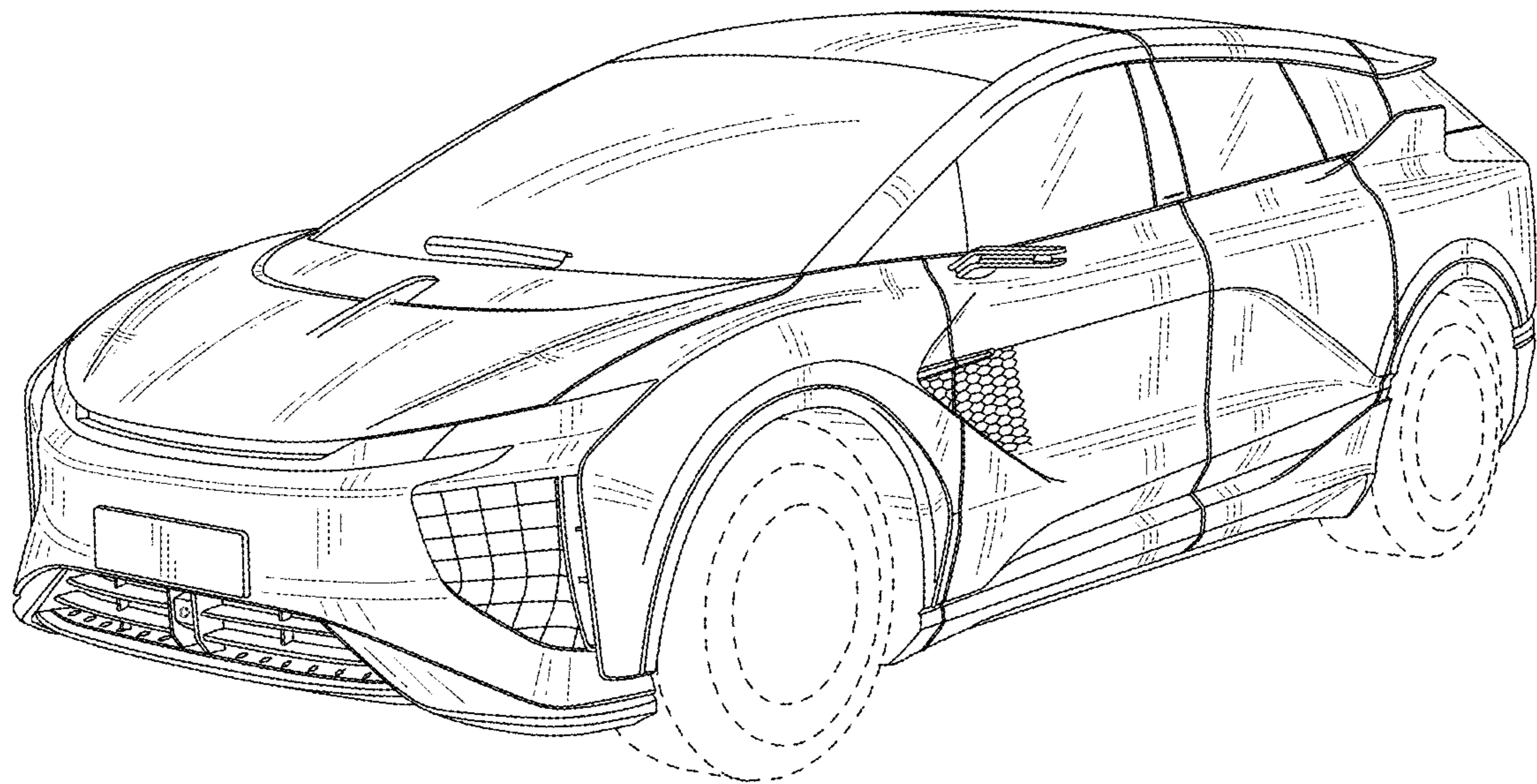

FIG. 6