



US00D959242S

(12) **United States Design Patent** (10) **Patent No.:** **US D959,242 S**  
**Rizzo** (45) **Date of Patent:** **\*\* Aug. 2, 2022**

(54) **VOLLEYBALL BED LEG COVER**  
(71) Applicant: **Sandra Jean Rizzo**, Kenosha, WI (US)  
(72) Inventor: **Sandra Jean Rizzo**, Kenosha, WI (US)  
(\*\*) Term: **15 Years**  
(21) Appl. No.: **29/742,237**

7,124,986 B1 \* 10/2006 Bailey ..... A47B 91/12  
248/188.9  
D557,598 S \* 12/2007 Hoelting ..... D8/402  
D571,101 S \* 6/2008 Linsenman ..... D3/238  
D616,289 S \* 5/2010 Frankel ..... D8/374  
D650,262 S \* 12/2011 Hinkle, III ..... D8/374  
D668,942 S \* 10/2012 McGarry ..... D8/374  
D682,078 S \* 5/2013 Chase ..... D8/374  
D793,211 S \* 8/2017 Exley ..... D8/374

(Continued)

(22) Filed: **Jun. 10, 2020**  
(51) **LOC (13) Cl.** ..... **08-05**  
(52) **U.S. Cl.**  
USPC ..... **D8/374**  
(58) **Field of Classification Search**  
USPC ..... D8/315, 321–322, 373–375;  
D21/707–710, 712–13, 780–781,  
D21/788–789, 799.1  
CPC ..... A47B 91/12; A47C 7/002; Y10T 16/216  
See application file for complete search history.

**OTHER PUBLICATIONS**

“Toe Guard-Bed Bumpers”, Apr. 10, 2012, Amazon.com, site visited Nov. 8, 2021: <https://www.amazon.com/Guard-bed-Bumpers-Against-Injuries-Package/dp/B007SRXQDQ> (Year: 2012).\*

(Continued)

*Primary Examiner* — Jack Reickel  
*Assistant Examiner* — Michael A Kervin  
(74) *Attorney, Agent, or Firm* — Davis & Kuelthau, sc;  
Joseph S. Heino; Erin E. Kaprelian

(56) **References Cited**  
**U.S. PATENT DOCUMENTS**

D166,618 S \* 4/1952 Mince ..... D6/610  
2,744,283 A \* 5/1956 Reineman ..... A47B 91/04  
16/42 R  
5,173,990 A \* 12/1992 Owen ..... B60B 33/0002  
16/18 CG  
D340,072 S \* 10/1993 Turner ..... D19/82  
D355,008 S \* 1/1995 Vitiello ..... D21/713  
D373,721 S \* 9/1996 Panow ..... D6/710  
D379,061 S \* 5/1997 Williams ..... D8/374  
D433,321 S \* 11/2000 Pattengell ..... D8/402  
D445,155 S \* 7/2001 Lee ..... D21/713  
D455,335 S \* 4/2002 Cort ..... D8/374  
6,418,578 B1 \* 7/2002 Polevoy ..... A47B 91/00  
16/18 CG  
D474,960 S \* 5/2003 West-Delgado ..... D8/402  
D487,392 S \* 3/2004 Chase ..... D8/374  
D491,793 S \* 6/2004 Corso ..... D8/374  
D512,870 S \* 12/2005 Rochon ..... D6/610

(57) **CLAIM**

The ornamental design for a volleyball bed leg cover, as shown and described.

**DESCRIPTION**

FIG. 1 is a front perspective view of volleyball bed leg cover showing my new design;  
FIG. 2 is a rear perspective view thereof;  
FIG. 3 is a top plan view thereof;  
FIG. 4 is a bottom plan view thereof;  
FIG. 5 is a rear elevation view thereof; and,  
FIG. 6 is a front elevation view thereof.  
The broken line showing of a volleyball bed leg cover is for the purpose of illustrating portions of the article and form no part of the claimed design. The dot-dash broken lines define the bounds of the claimed design and form no part thereof.

**1 Claim, 6 Drawing Sheets**

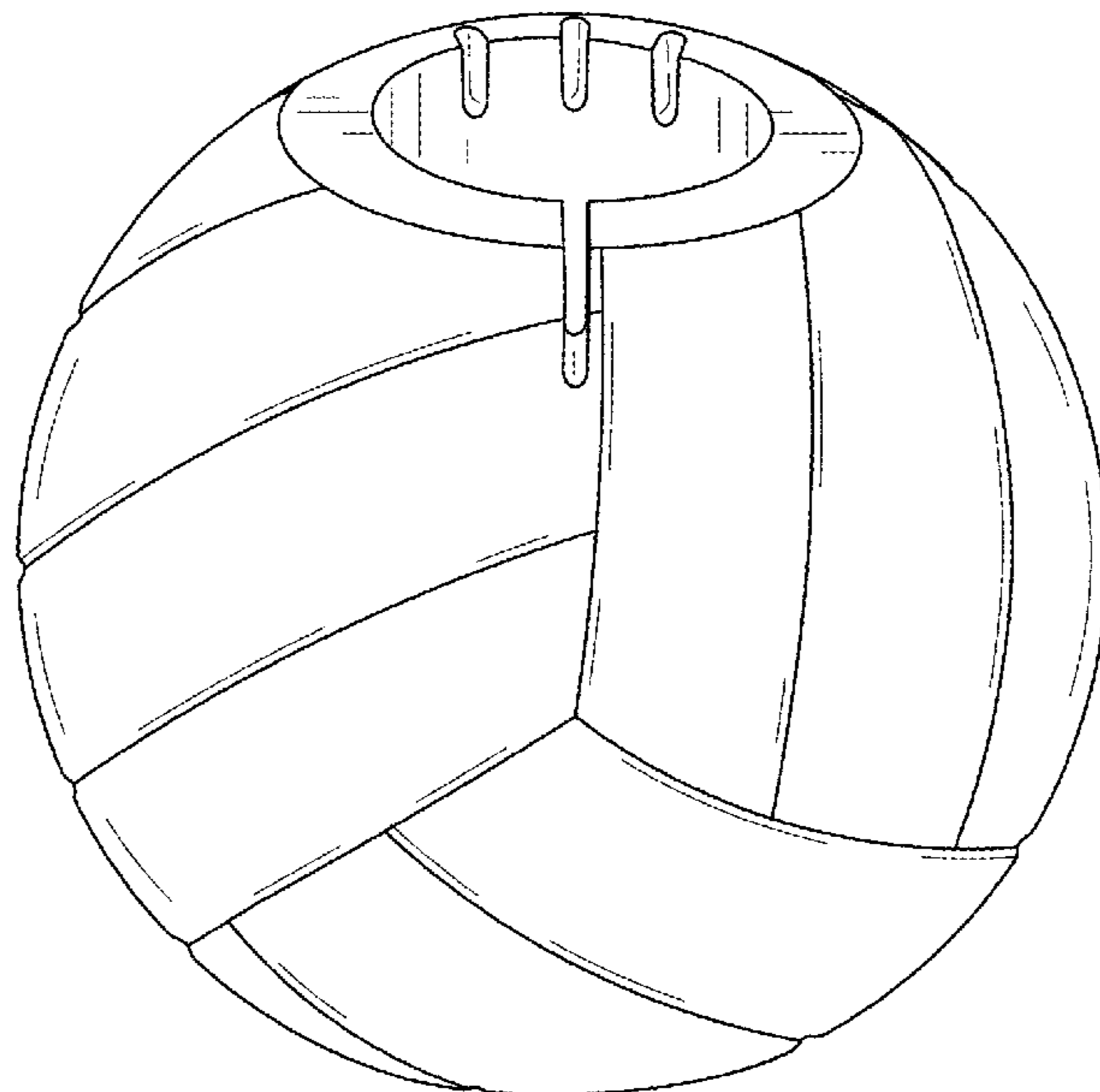

(56)

**References Cited**

U.S. PATENT DOCUMENTS

D925,342 S \* 7/2021 Winthrop ..... D8/374  
D945,868 S \* 3/2022 Rizzo ..... D8/374  
2007/0220703 A1\* 9/2007 LaPointe ..... A47B 91/06  
16/42 R  
2008/0258023 A1\* 10/2008 Desmarais ..... A47C 7/002  
248/188.9  
2012/0061545 A1\* 3/2012 Schneider ..... A47B 91/00  
248/345.1  
2013/0019410 A1\* 1/2013 Willis ..... A47B 91/12  
5/663  
2019/0357691 A1\* 11/2019 Rizzo ..... F21V 23/0471  
2020/0093265 A1\* 3/2020 Becker ..... A47B 91/12

OTHER PUBLICATIONS

“Bed Leg Toe Cushion”, Sep. 10, 2017, Amazon.com, site visited  
Nov. 8, 2021: <https://www.amazon.com/Cushion-Beige-Prevents-injuries-stubs/dp/B075JBFT2H> (Year: 2017).\*

“GALINPO Volleyball Shaped Wall Protector”, Nov. 29, 2019,  
Amazon.in, site visited Dec. 28, 2021: <https://www.amazon.in/GALINPO-Adhesive-Stopper-Prevent-Protector/dp/B08264Y7FL> (Year:  
201).\*

\* cited by examiner

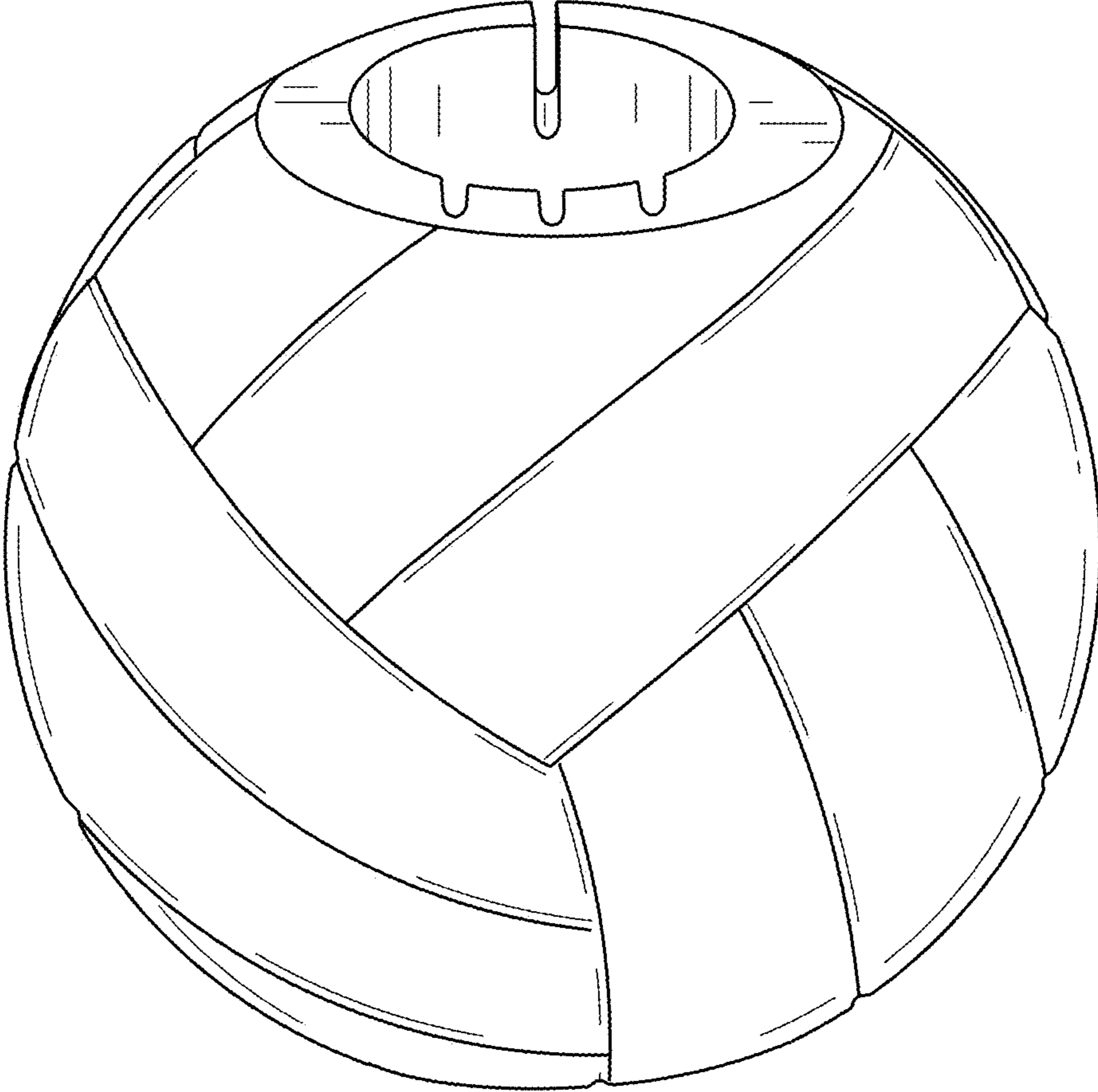

FIG. 1

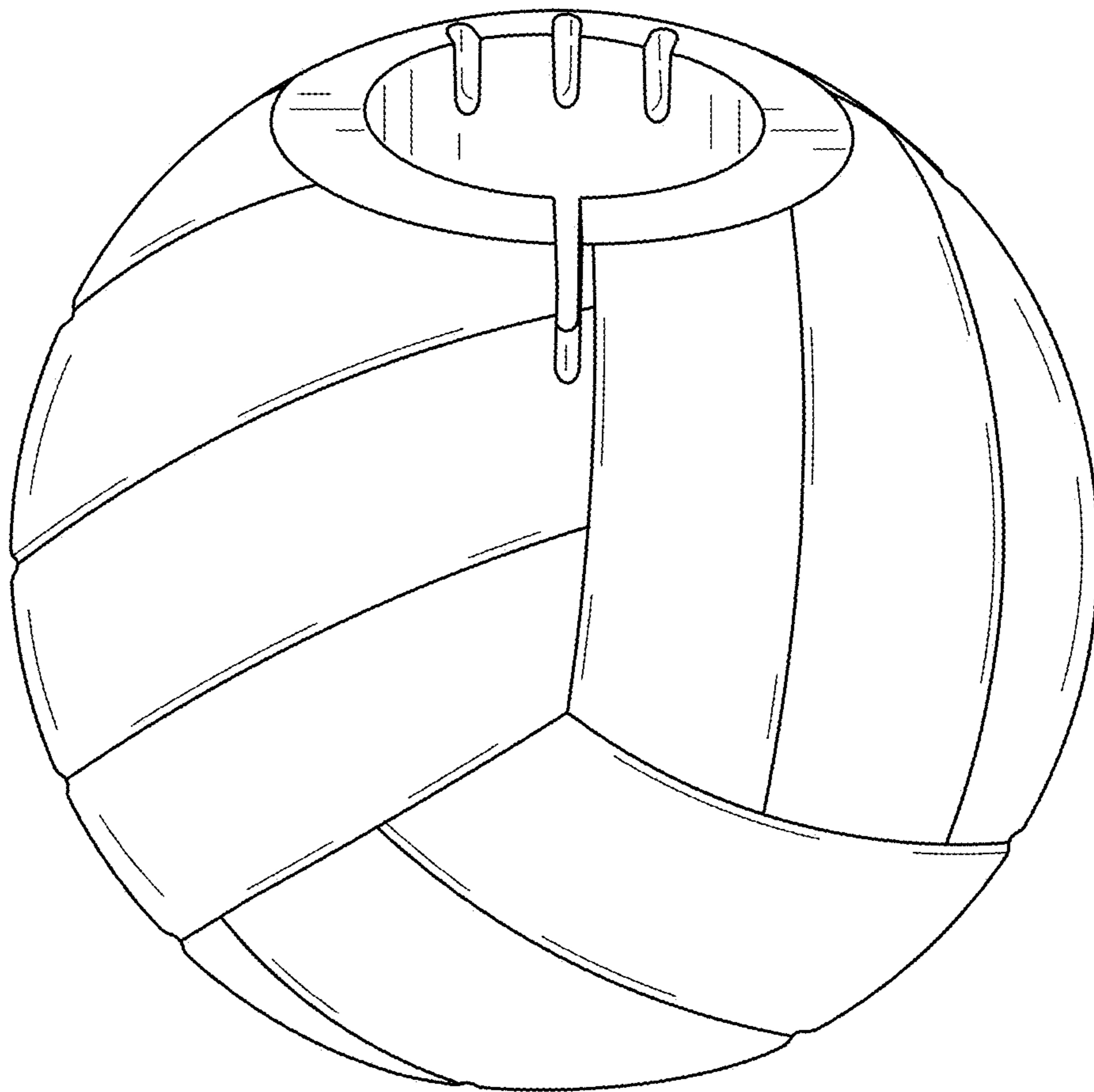

FIG. 2

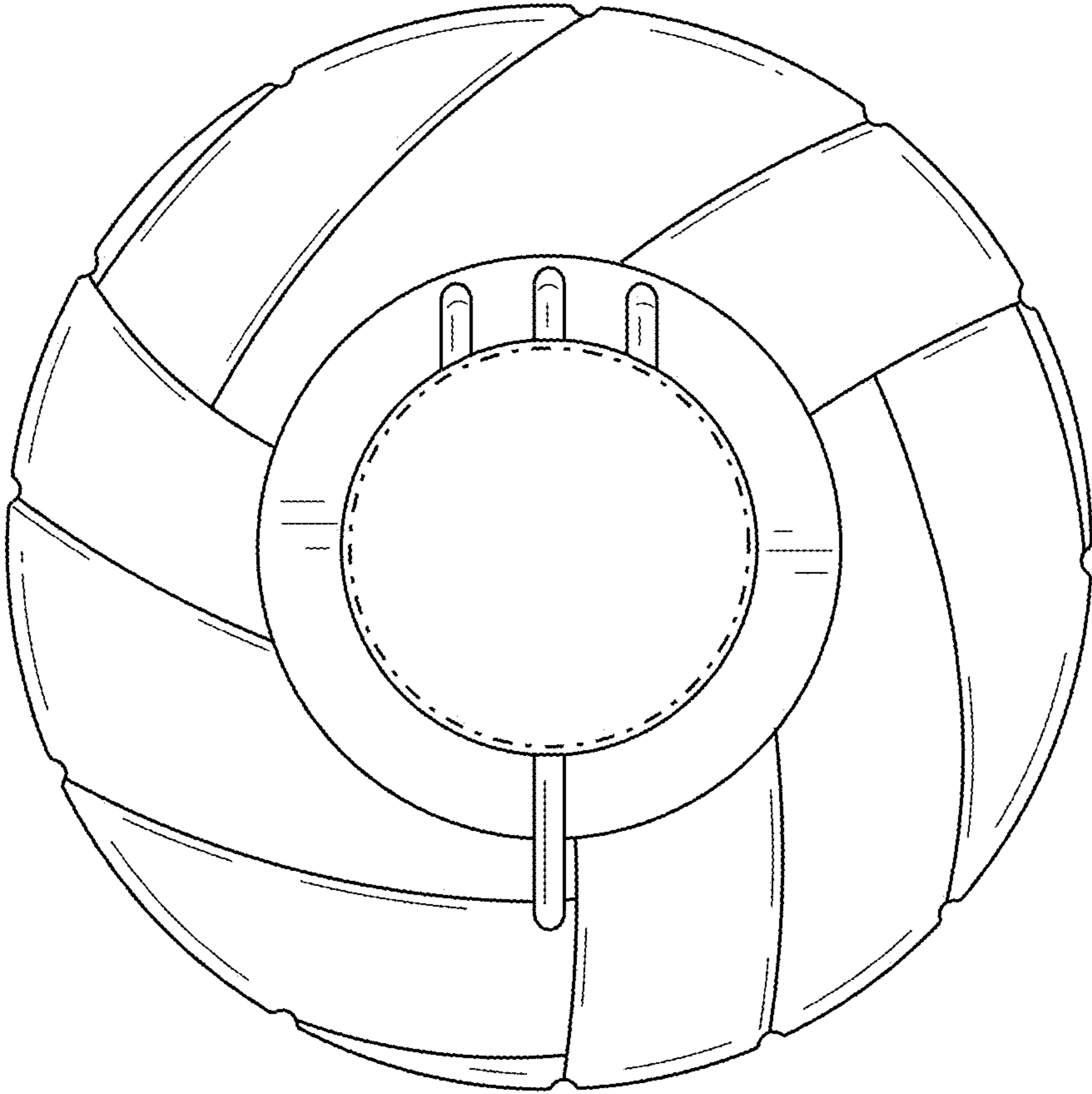

FIG. 3

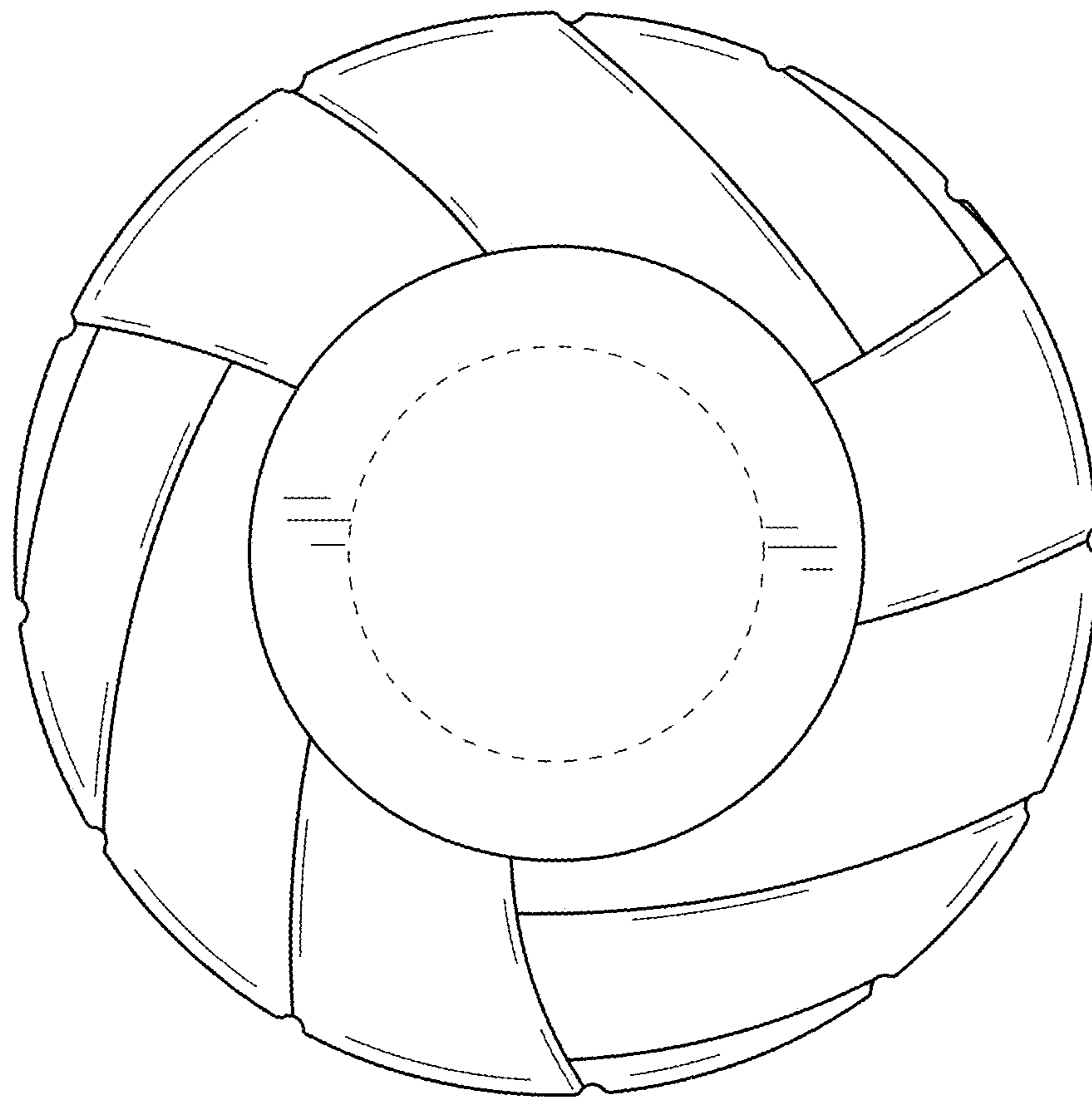

FIG. 4

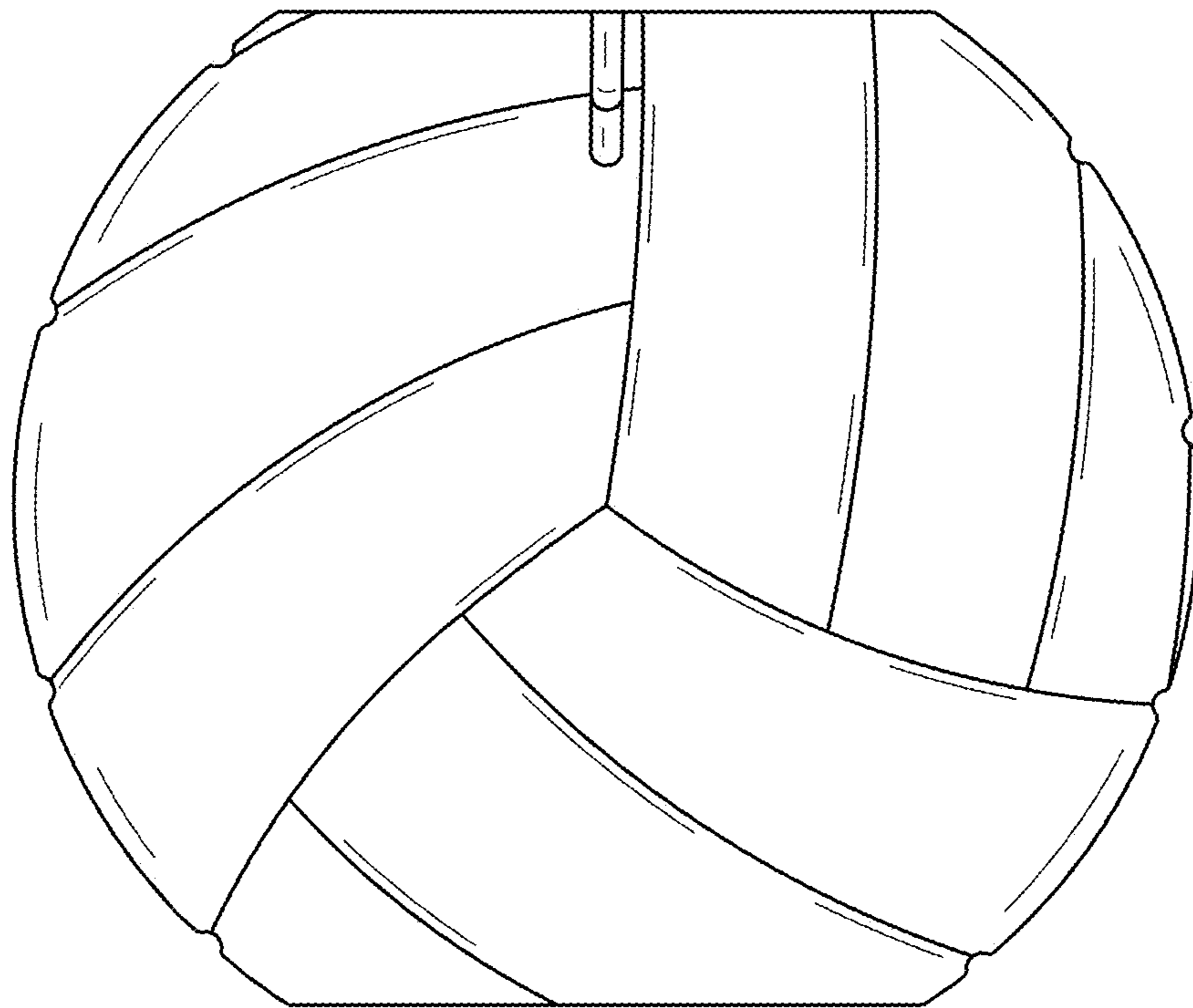

FIG. 5

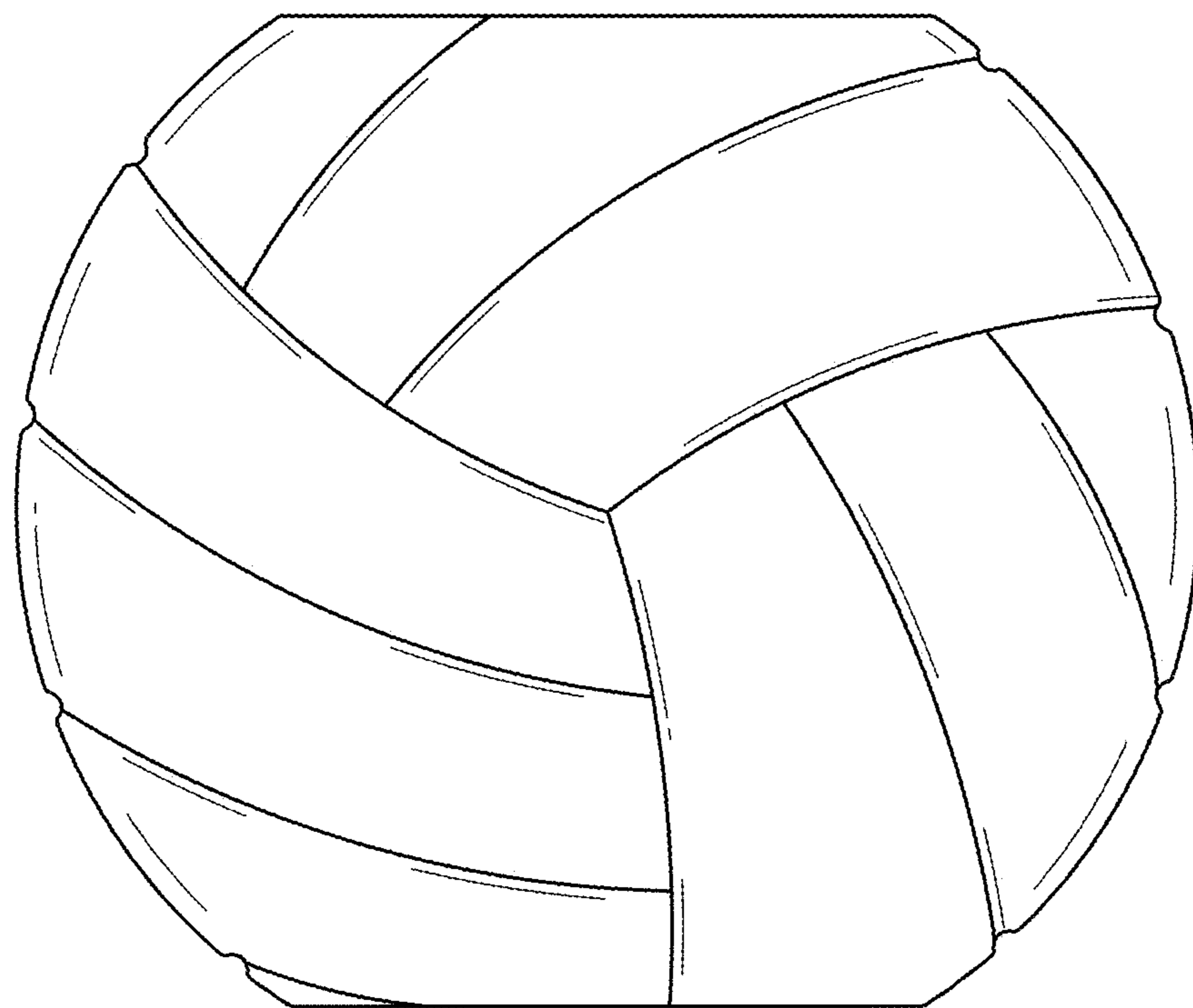

FIG. 6