



US00D959184S

(12) **United States Design Patent** (10) **Patent No.:** **US D959,184 S**
Seidl (45) **Date of Patent:** **** Aug. 2, 2022**

(54) **MACHINE FOR PREPARING BEVERAGES**

(71) Applicant: **Luigi Lavazza S.p.A.**, Turin (IT)

(72) Inventor: **Florian Seidl**, Turin (IT)

(73) Assignee: **Luigi Lavazza S.p.A.**, Turin (IT)

(**) Term: **15 Years**

(21) Appl. No.: **35/510,288**

(22) Filed: **Mar. 6, 2020**

(80) **Hague Agreement Data**

Int. Filing Date: **Mar. 6, 2020**

Int. Reg. No.: **DM/206530**

Int. Reg. Date: **Mar. 6, 2020**

Int. Reg. Pub. Date: **Sep. 18, 2020**

(51) **LOC (13) Cl.** **07-01**

(52) **U.S. Cl.**
USPC **D7/306; D7/311**

(58) **Field of Classification Search**
USPC **D7/306, 309, 311, 362, 365, 367**
CPC **A47J 31/462; A23F 5/262**
See application file for complete search history.

(56) **References Cited**

U.S. PATENT DOCUMENTS

D544,286 S *	6/2007	Cahen	D7/306
D584,095 S *	1/2009	Luippold	D7/306
D623,000 S *	9/2010	Murauyou	D7/309
D666,451 S *	9/2012	Cheng	D7/309
D677,509 S *	3/2013	Wang	D7/306
D681,385 S *	5/2013	Ring	D7/306
D718,565 S *	12/2014	Spagnolo	D7/309
D721,248 S *	1/2015	Manly	D7/399
D723,317 S *	3/2015	Manly	D7/306
D735,516 S *	8/2015	Burrows	D7/309
D757,477 S *	5/2016	Wang	D7/306
D758,120 S *	6/2016	Garman	D7/309
D777,498 S *	1/2017	Bandixen	D7/306

D779,257 S *	2/2017	Hale	D7/306
D831,398 S *	10/2018	Cahen	D7/306
D832,019 S *	10/2018	Cahen	D7/306
D836,371 S *	12/2018	Cahen	D7/306
D838,532 S *	1/2019	Seidl	D7/311
D840,733 S *	2/2019	Hale	D7/306
D853,167 S *	7/2019	Koury	D7/306
D858,167 S *	9/2019	Lenart	D7/306
D862,143 S *	10/2019	Stefanoni	D7/309
D879,530 S *	3/2020	Cauwood	D7/306
D879,531 S *	3/2020	Cauwood	D7/306
D881,626 S *	4/2020	Borrelli	D7/309
D888,485 S *	6/2020	Kim	D7/306
D891,847 S *	8/2020	Seidl	D7/309

(Continued)

OTHER PUBLICATIONS

Facebook website, NIMS SpA page, Publication date Feb. 17, 2021, [site visited Aug. 19, 2021], Available on the Internet URL <https://www.facebook.com/NimsSpa/photos/a.408644275836177/4124790980888136> (Year: 2021).*

(Continued)

Primary Examiner — S. Bryan Reinholdt, Jr.

(74) *Attorney, Agent, or Firm* — Nixon & Vanderhye P.C.

(57) **CLAIM**

The ornamental design for a machine for preparing beverages, as shown and described.

DESCRIPTION

1. Machine for preparing beverages
FIG. 1.1 is a front, right, and top perspective view of the machine for preparing beverages showing my new design; FIG. 1.2 is a rear, right, and top perspective view thereof; FIG. 1.3 is a top plan view thereof; FIG. 1.4 is a front elevation view thereof; FIG. 1.5 is a rear elevation view thereof; FIG. 1.6 is a left side elevation view thereof; and FIG. 1.7 is a right side elevation view thereof.

1 Claim, 7 Drawing Sheets

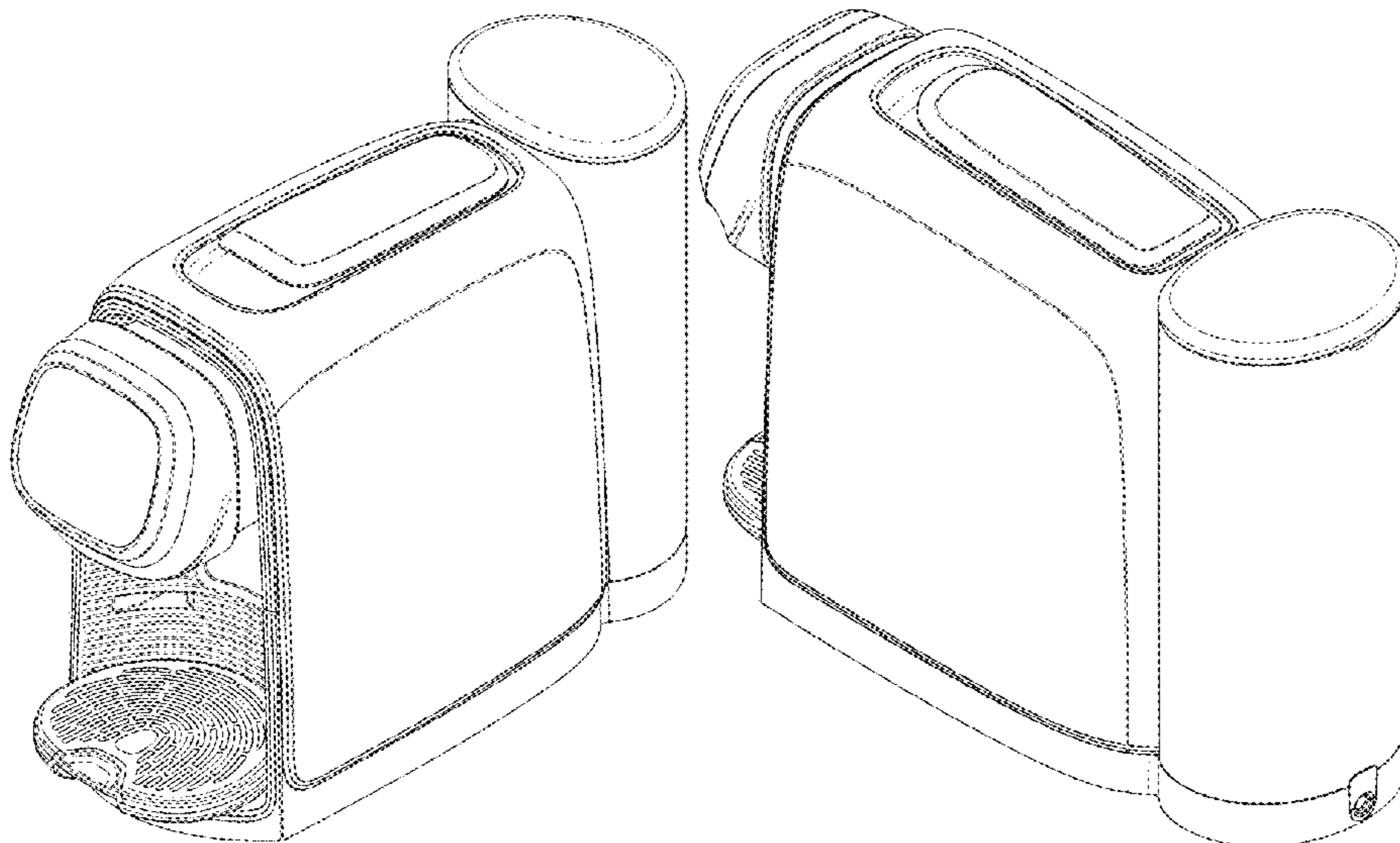

(56)

References Cited

U.S. PATENT DOCUMENTS

2010/0251900 A1* 10/2010 Cahen A47J 31/3619
99/295
2015/0201790 A1* 7/2015 Smith A47J 31/3628
426/431
2020/0178721 A1* 6/2020 Byun A47J 31/3676

OTHER PUBLICATIONS

Facebook website, NIMS SpA page, Publication date Dec. 11, 2020, [site visited Aug. 19, 2021], Available on the Internet URL <https://www.facebook.com/NimsSpa/videos/1060946924334221> (Year: 2020).*

A'Design Award website, Lavazza Elogy Milk Coffee Machine, Publication date unknown, [site visited Aug. 19, 2021], Available on the Internet URL <https://competition.adesignaward.com/design.php?ID=123094> (Year: 2021).*

* cited by examiner

1.1

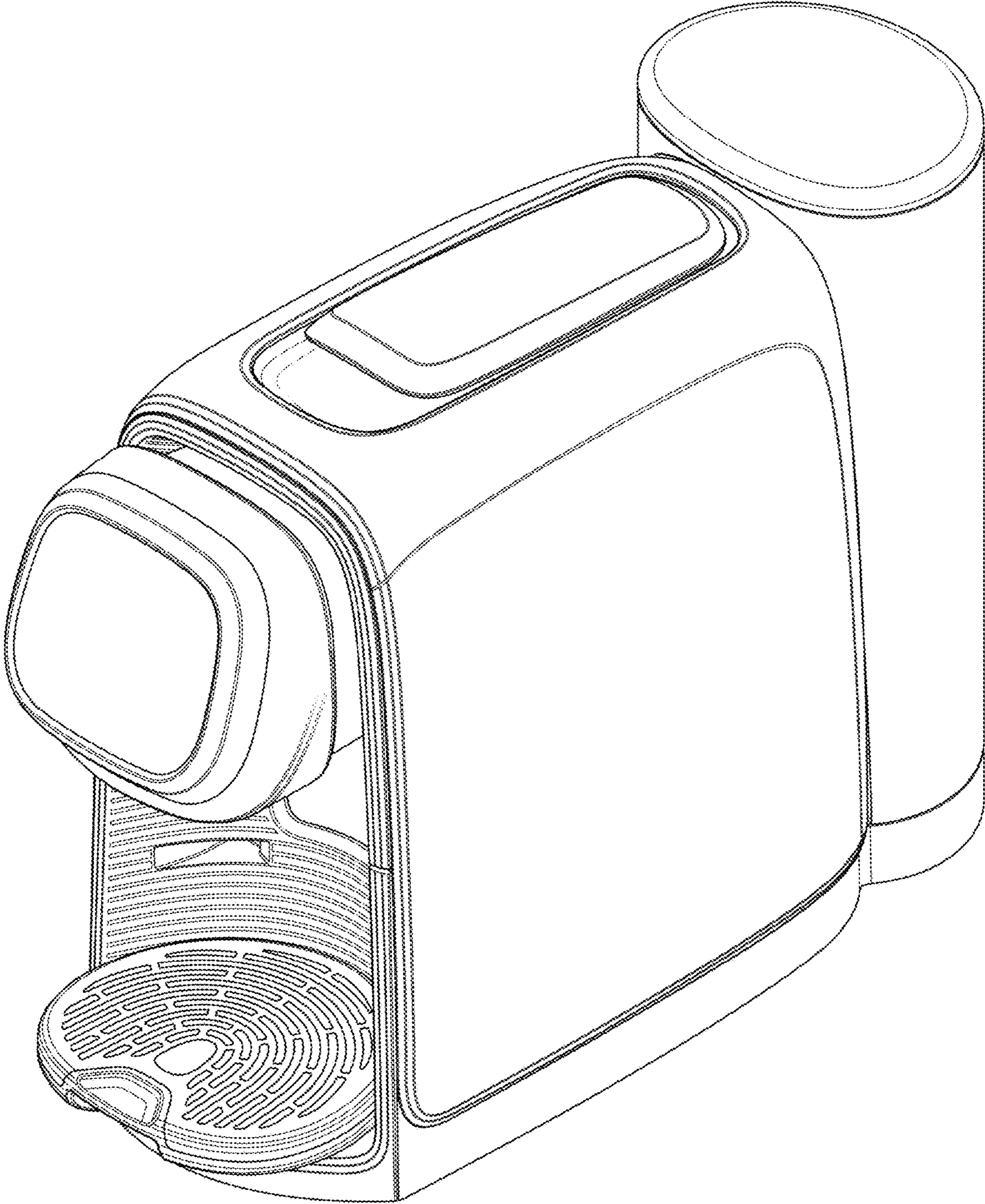

1.2

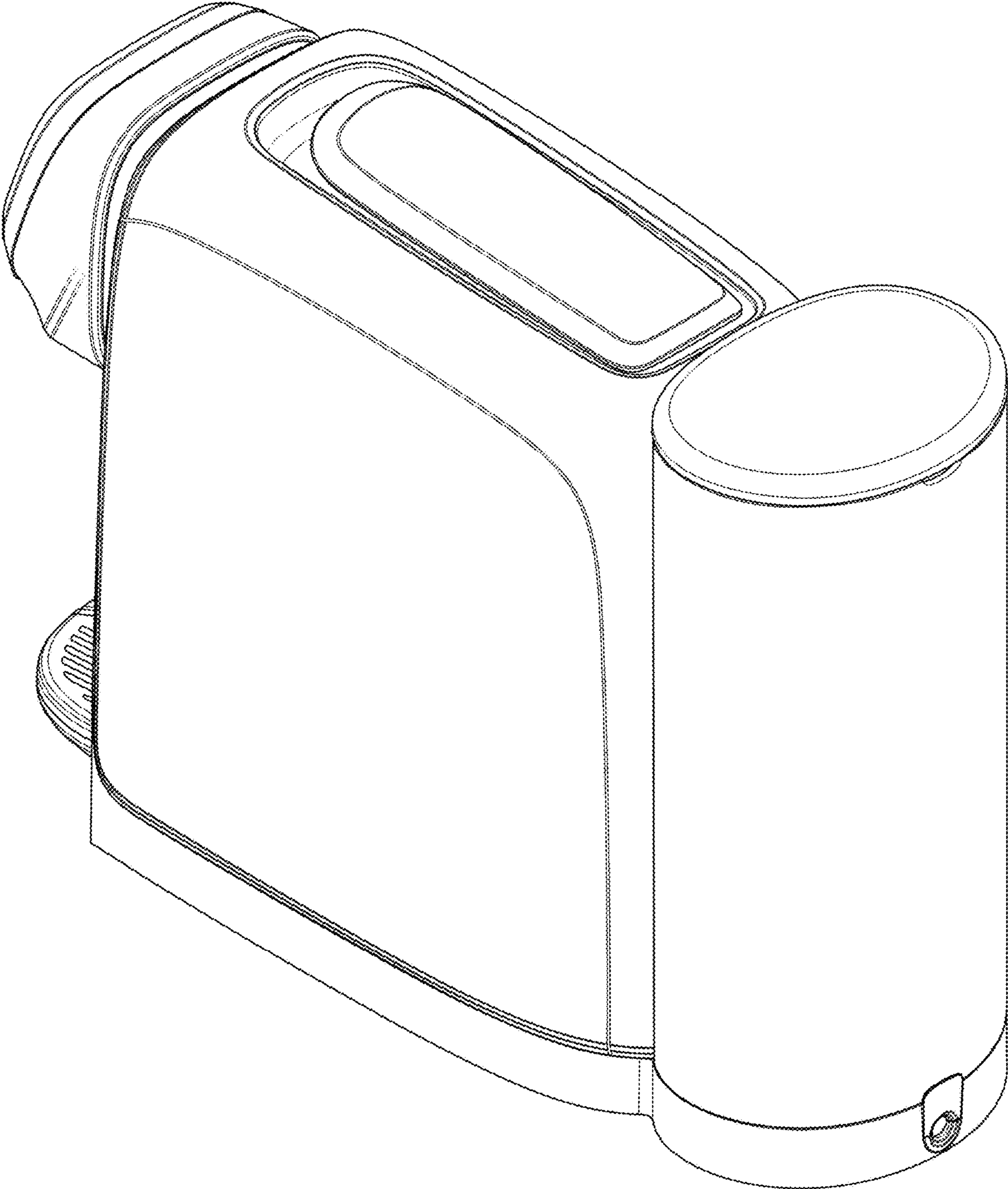

1.3

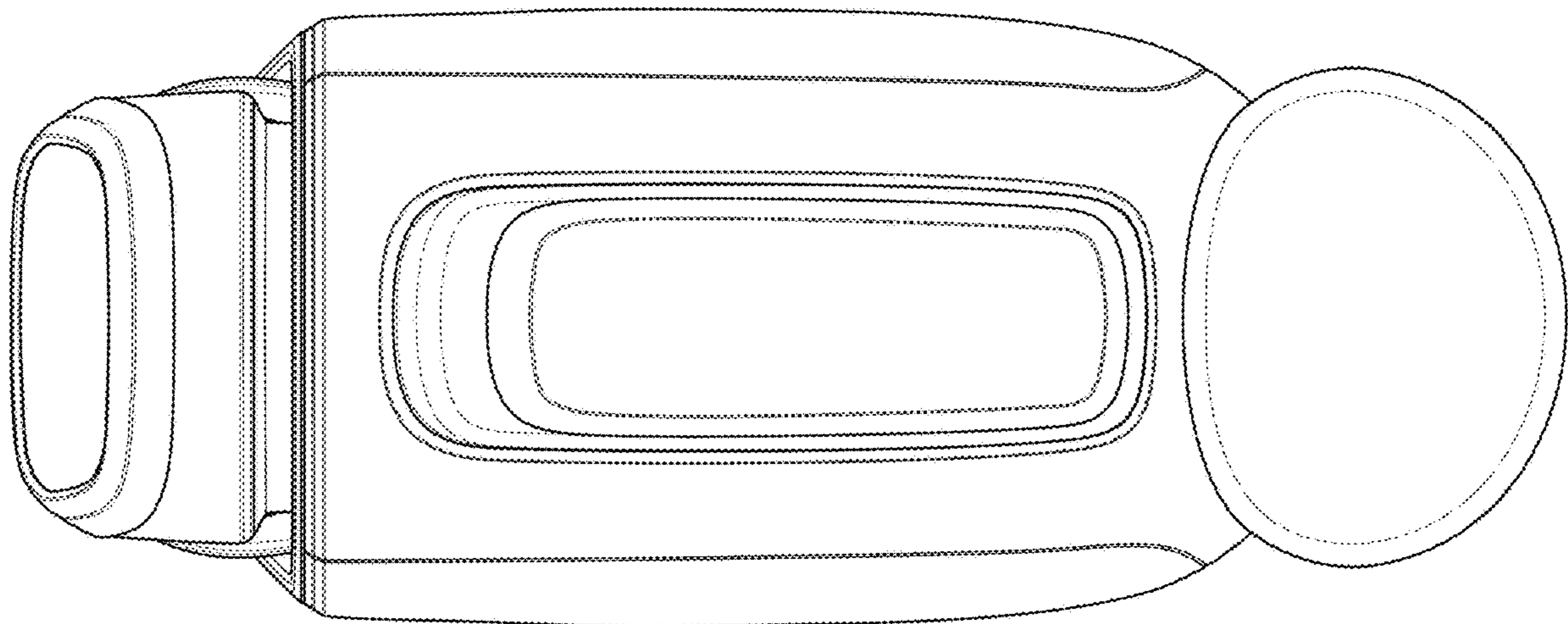

1.4

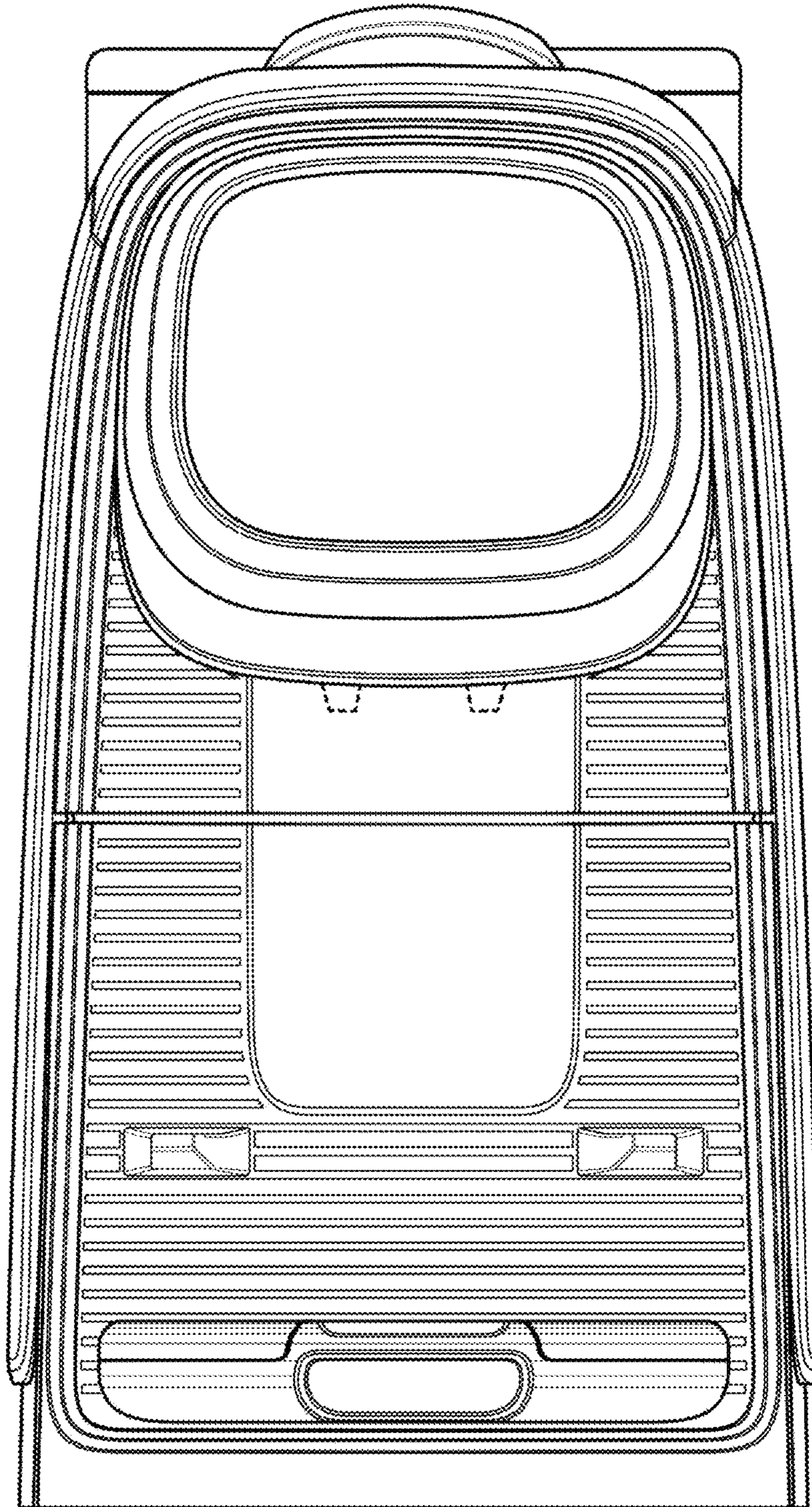

1.5

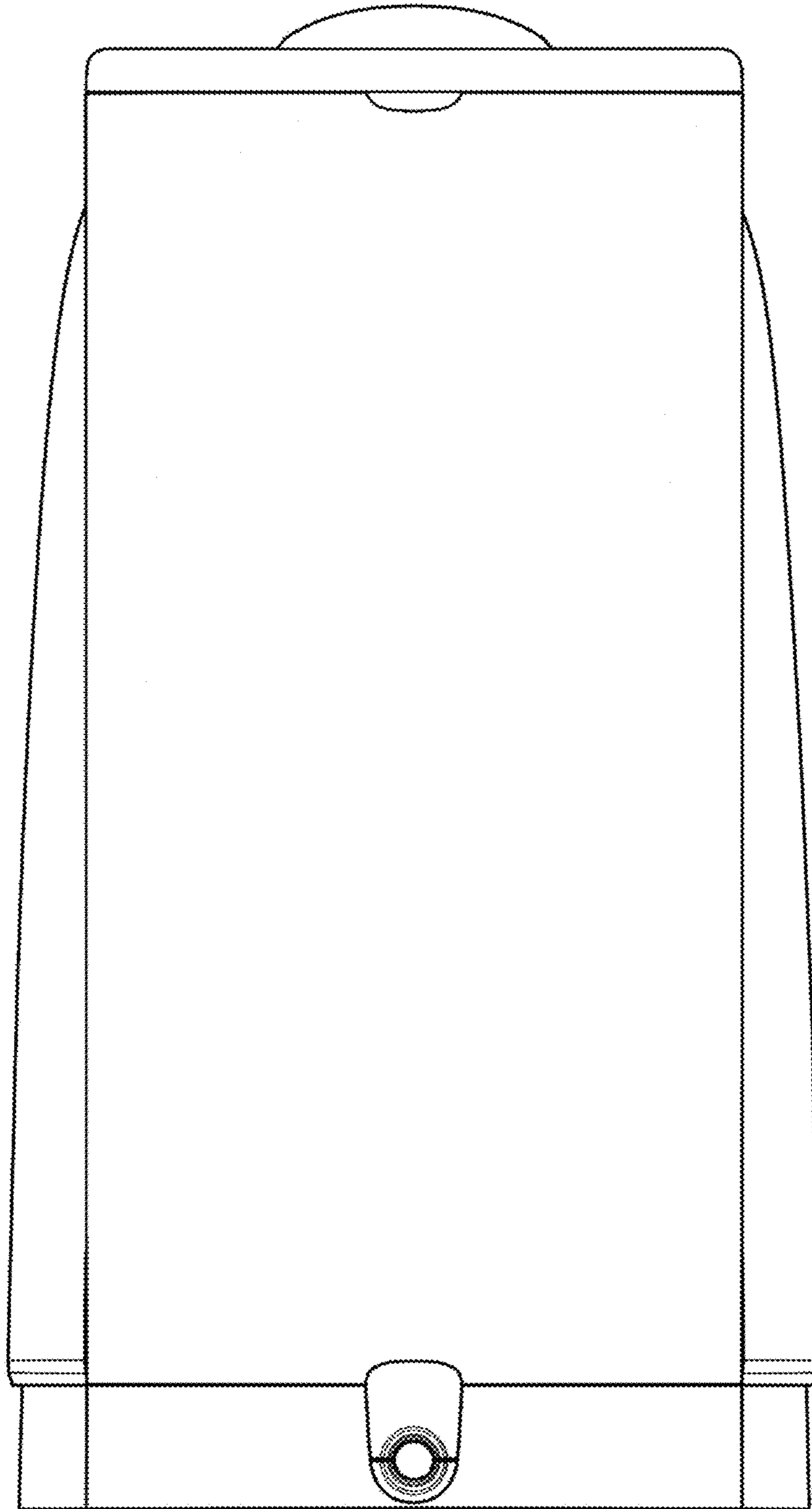

1.6

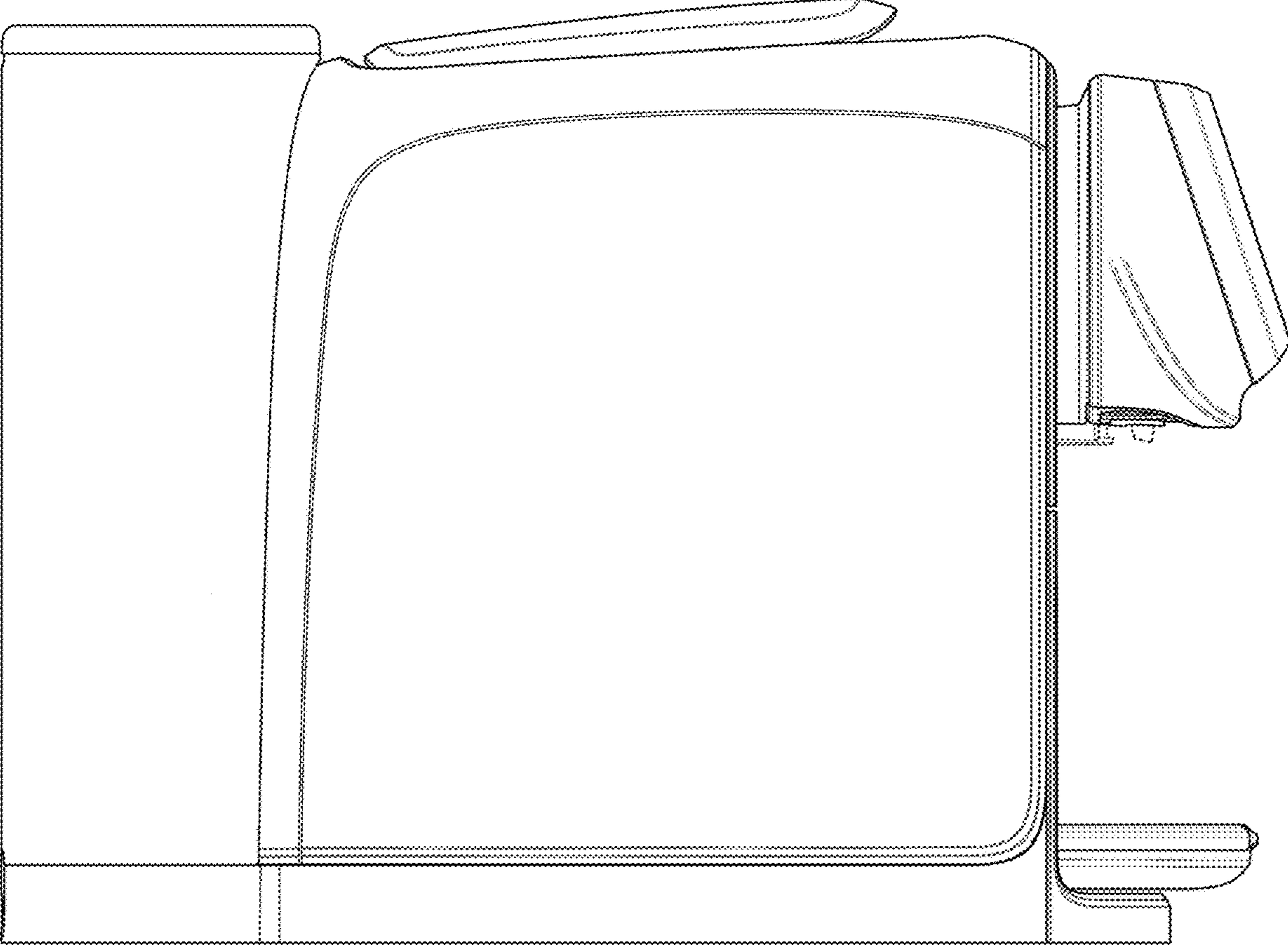

1.7

