



US00D959067S

(12) **United States Design Patent**  
**Fitzsimmons**

(10) **Patent No.:** **US D959,067 S**  
(45) **Date of Patent:** **\*\* Jul. 26, 2022**

- (54) **VEHICLE WASHER BRUSH PANEL WITH PARTIALLY EMBEDDED NODULES**
- (71) Applicant: **IWASH TECHNOLOGY LLC**,  
Milwaukie, OR (US)
- (72) Inventor: **Jeff R. Fitzsimmons**, Mulino, OR (US)
- (73) Assignee: **iWash Technology LLC**, Milwaukie,  
OR (US)
- (\*\*) Term: **15 Years**
- (21) Appl. No.: **29/684,670**
- (22) Filed: **Mar. 22, 2019**
- (51) **LOC (13) Cl.** ..... **15-05**
- (52) **U.S. Cl.**  
USPC ..... **D32/4**
- (58) **Field of Classification Search**  
USPC ..... D32/1, 4, 25, 28; D6/575, 578  
(Continued)

(56) **References Cited**

**U.S. PATENT DOCUMENTS**

- 2,752,993 A \* 7/1956 Scott ..... A47H 23/02  
4/608
- 3,237,348 A \* 3/1966 Block ..... B24D 13/06  
451/182

(Continued)

**FOREIGN PATENT DOCUMENTS**

- GB 6099857 \* 9/2020
- JP 3097987 U \* 2/2004

(Continued)

**OTHER PUBLICATIONS**

Pearl panel for c-channel cores, announced in YouTube on Apr. 27, 2019 [online], [site visited Feb. 28, 2022], Available from the internet URL: Pearl panel for c-channel cores (Year: 2019).\*

(Continued)

*Primary Examiner* — Amy C Wierenga  
*Assistant Examiner* — Jennylou M Binas  
(74) *Attorney, Agent, or Firm* — Renaissance IP Law Group, LLP; David A. Crowther

(57) **CLAIM**

The ornamental design for a vehicle washer brush panel with partially embedded nodules, as shown and described.

**DESCRIPTION**

FIG. 1 is a perspective view of a vehicle washer brush panel with partially embedded nodules according to a first embodiment of my new design;  
 FIG. 2 is a front view of the vehicle washer brush panel with partially embedded nodules of FIG. 1;  
 FIG. 3 is a back view of the vehicle washer brush panel with partially embedded nodules of FIG. 1;  
 FIG. 4 is a first side view of the vehicle washer brush panel with partially embedded nodules of FIG. 1;  
 FIG. 5 is a second side view of the vehicle washer brush panel with partially embedded nodules of FIG. 1;  
 FIG. 6 is a top view of the vehicle washer brush panel with partially embedded nodules of FIG. 1;  
 FIG. 7 is a bottom view of the vehicle washer brush panel with partially embedded nodules of FIG. 1;  
 FIG. 8 is a perspective view of a vehicle washer brush panel with partially embedded nodules according to a second embodiment of my new design;  
 FIG. 9 is a front view of the vehicle washer brush panel with partially embedded nodules of FIG. 8;  
 FIG. 10 is a back view of the vehicle washer brush panel with partially embedded nodules of FIG. 8;  
 FIG. 11 is a first side view of the vehicle washer brush panel with partially embedded nodules of FIG. 8;  
 FIG. 12 is a second side view of the vehicle washer brush panel with partially embedded nodules of FIG. 8;  
 FIG. 13 is a top view of the vehicle washer brush panel with partially embedded nodules of FIG. 8;  
 FIG. 14 is a bottom view of the vehicle washer brush panel with partially embedded nodules of FIG. 8;  
 FIG. 15 is a perspective view of a vehicle washer brush panel with partially embedded nodules according to a third embodiment of my new design;

(Continued)

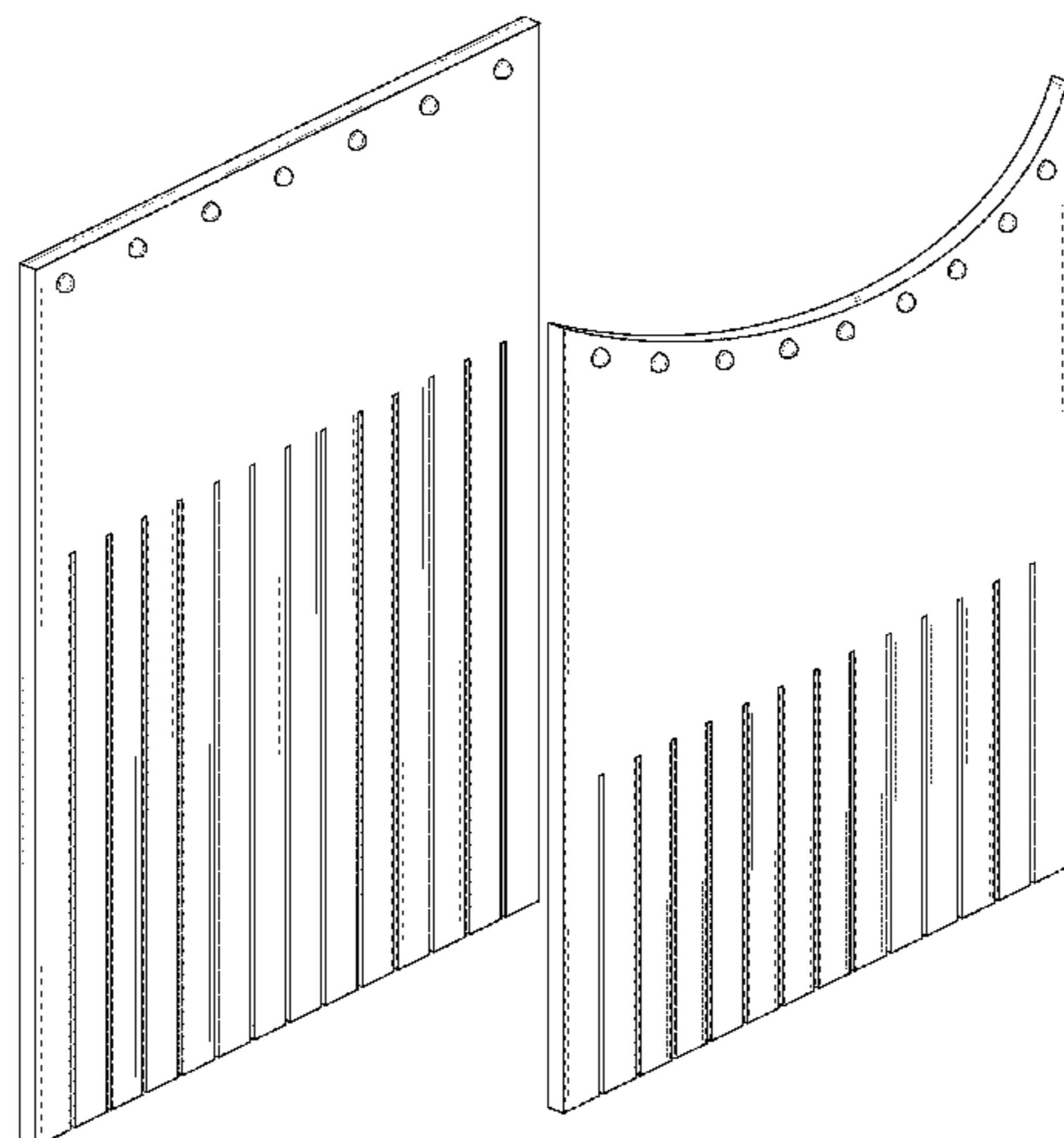

FIG. 16 is a front view of the vehicle washer brush panel with partially embedded nodules of FIG. 15;  
 FIG. 17 is a back view of the vehicle washer brush panel with partially embedded nodules of FIG. 15;  
 FIG. 18 is a first side view of the vehicle washer brush panel with partially embedded nodules of FIG. 15;  
 FIG. 19 is a second side view of the vehicle washer brush panel with partially embedded nodules of FIG. 15;  
 FIG. 20 is a top view of the vehicle washer brush panel with partially embedded nodules of FIG. 15; and,  
 FIG. 21 is a bottom view of the vehicle washer brush panel with partially embedded nodules of FIG. 15.

**1 Claim, 18 Drawing Sheets**

(58) **Field of Classification Search**

CPC .... B60S 3/00; B60S 3/04; B60S 3/048; B60S 3/06; B60S 3/063; B08B 9/045; A46B 11/066; A46B 13/005; A46B 2200/3046; Y10S 15/02

See application file for complete search history.

(56) **References Cited**

U.S. PATENT DOCUMENTS

3,765,043 A \* 10/1973 Lesser ..... B60S 3/04  
 15/DIG. 2  
 3,918,171 A \* 11/1975 Hull ..... B60S 3/002  
 34/233  
 4,057,866 A \* 11/1977 Belanger ..... B60S 3/04  
 15/DIG. 2  
 D247,437 S \* 3/1978 Nelson ..... D32/4  
 D298,373 S \* 11/1988 Nelson ..... D32/4  
 5,461,745 A \* 10/1995 Nittoli ..... A46B 3/18  
 451/469  
 D441,244 S \* 5/2001 Jerrell ..... D6/575  
 6,279,190 B1 \* 8/2001 Belanger ..... A46D 1/00  
 15/230.19

D671,782 S \* 12/2012 Braimah ..... D6/575  
 9,038,211 B2 \* 5/2015 Hedaya ..... A47K 3/38  
 4/557  
 9,079,566 B2 \* 7/2015 Belanger ..... A46B 13/006  
 D799,855 S \* 10/2017 Webb ..... D6/575  
 10,710,559 B2 \* 7/2020 Belanger ..... B66F 7/0666  
 2009/0133728 A1 \* 5/2009 Kim Brillouet ..... B08B 3/00  
 134/57 R  
 2010/0017979 A1 \* 1/2010 Ennis ..... B60S 3/063  
 15/53.3  
 2013/0104332 A1 \* 5/2013 Belanger ..... A46B 13/001  
 15/246  
 2014/0130249 A1 \* 5/2014 Krumm ..... A47K 3/38  
 4/608  
 2016/0278582 A1 \* 9/2016 Kulasic ..... A47K 3/38  
 2016/0353940 A1 \* 12/2016 Smith ..... F21K 2/00  
 2020/0298805 A1 \* 9/2020 Fitzsimmons ..... B60S 3/04  
 2022/0031054 A1 \* 2/2022 Arakaki ..... A46B 5/02

FOREIGN PATENT DOCUMENTS

JP 4586881 B2 \* 11/2010 ..... A46B 3/16  
 JP 3186508 U \* 10/2013  
 KR 300855271.0000 \* 5/2016

OTHER PUBLICATIONS

45 Degree Side Washer, available in [iwashtechology.com](https://iwashtechology.com), 45 pearl panel video announced Apr. 27, 2019 [online], [site visited Feb. 28, 2022], Internet URL: <https://iwashtechology.com/45-degree-side-washer/and-45-degree-pearl-panel> (Year: 2019).\*

Car Wash Equipment-Grill Brush, announced in YouTube on May 15, 2012 [online], [site visited Feb. 28, 2022], Available from the internet URL: Car Wash Equipment—Grill Brush (Year: 2012).\*

Express Car Wash, announced in YouTube on Sep. 6, 2021 [online], [site visited Feb. 28, 2022], Available from the internet URL: Express Car Wash (Year: 2021).\*

The Importance of Proper Car Wash Brush Lubrication, announced in YouTube on Aug. 24, 2018 [online], [site visited Feb. 28, 2022], Available from the internet URL: The Importance of Proper Car Wash Brush Lubrication (Year: 2018).\*

\* cited by examiner

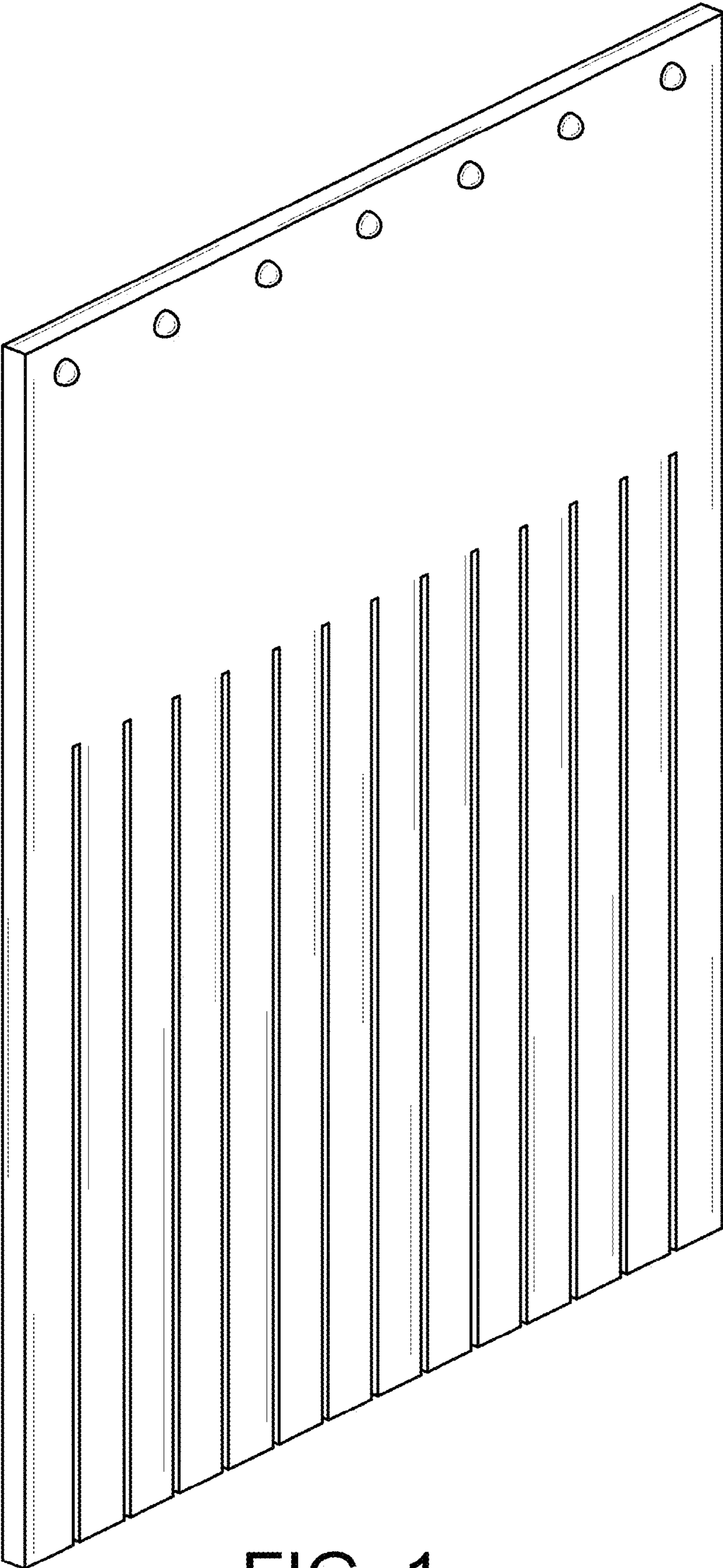

FIG. 1

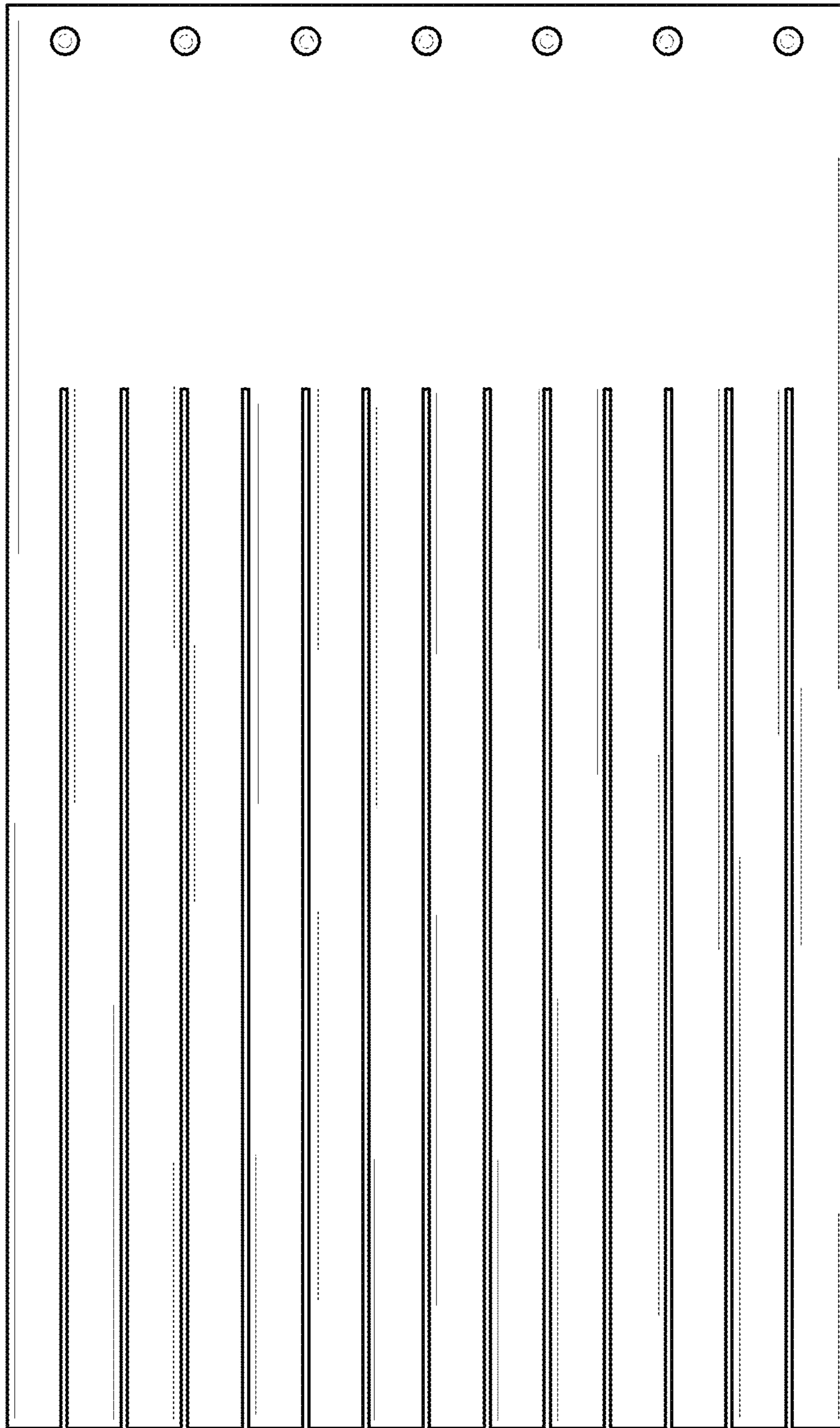

FIG. 2

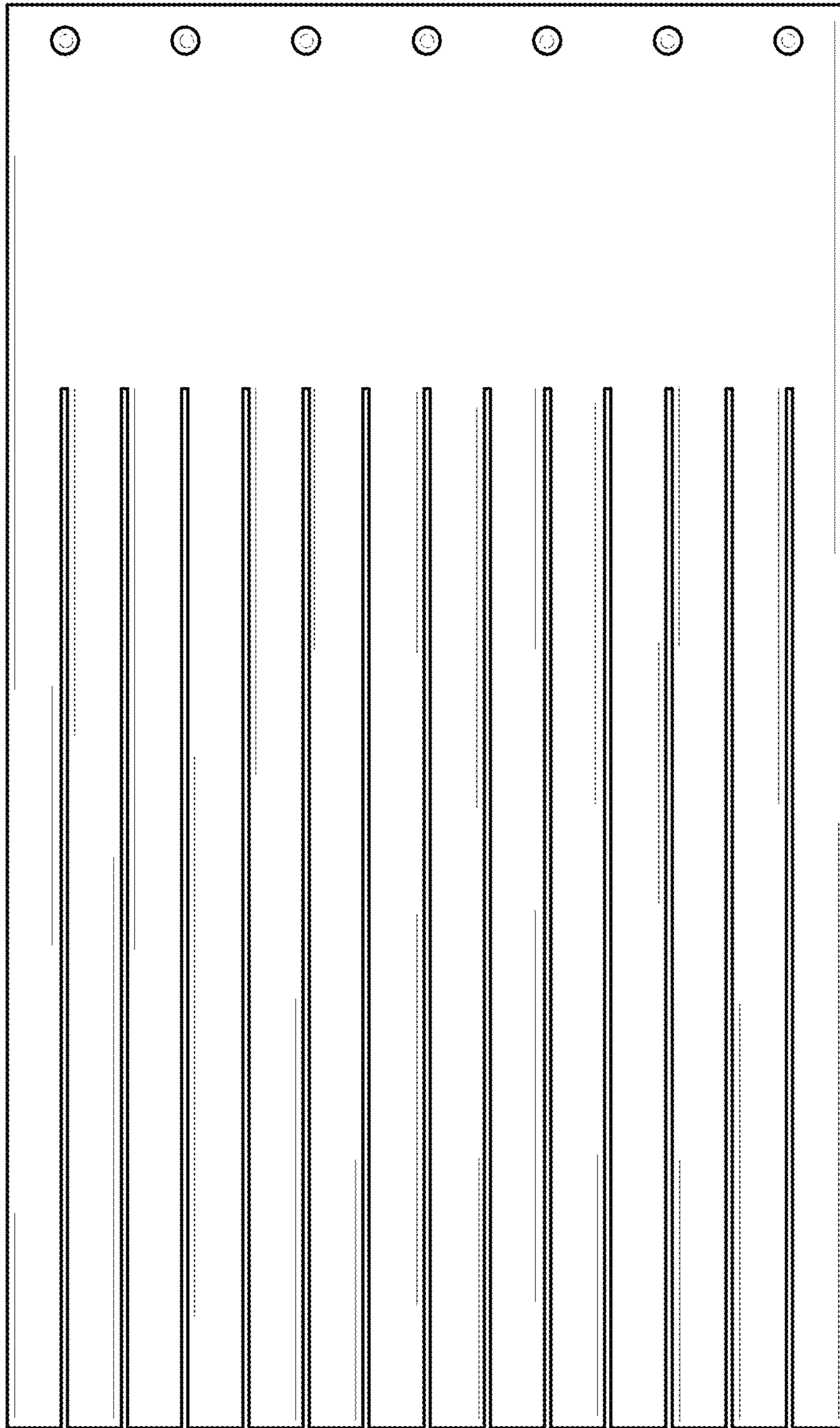

FIG. 3

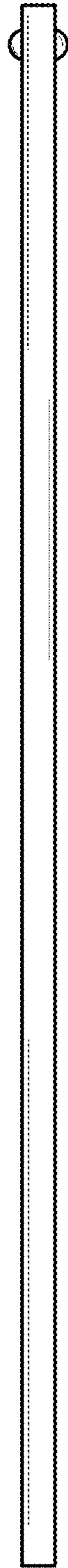

FIG. 4



FIG. 5

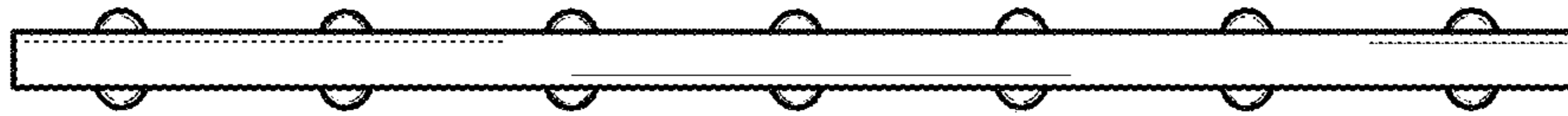

FIG. 6



FIG. 7



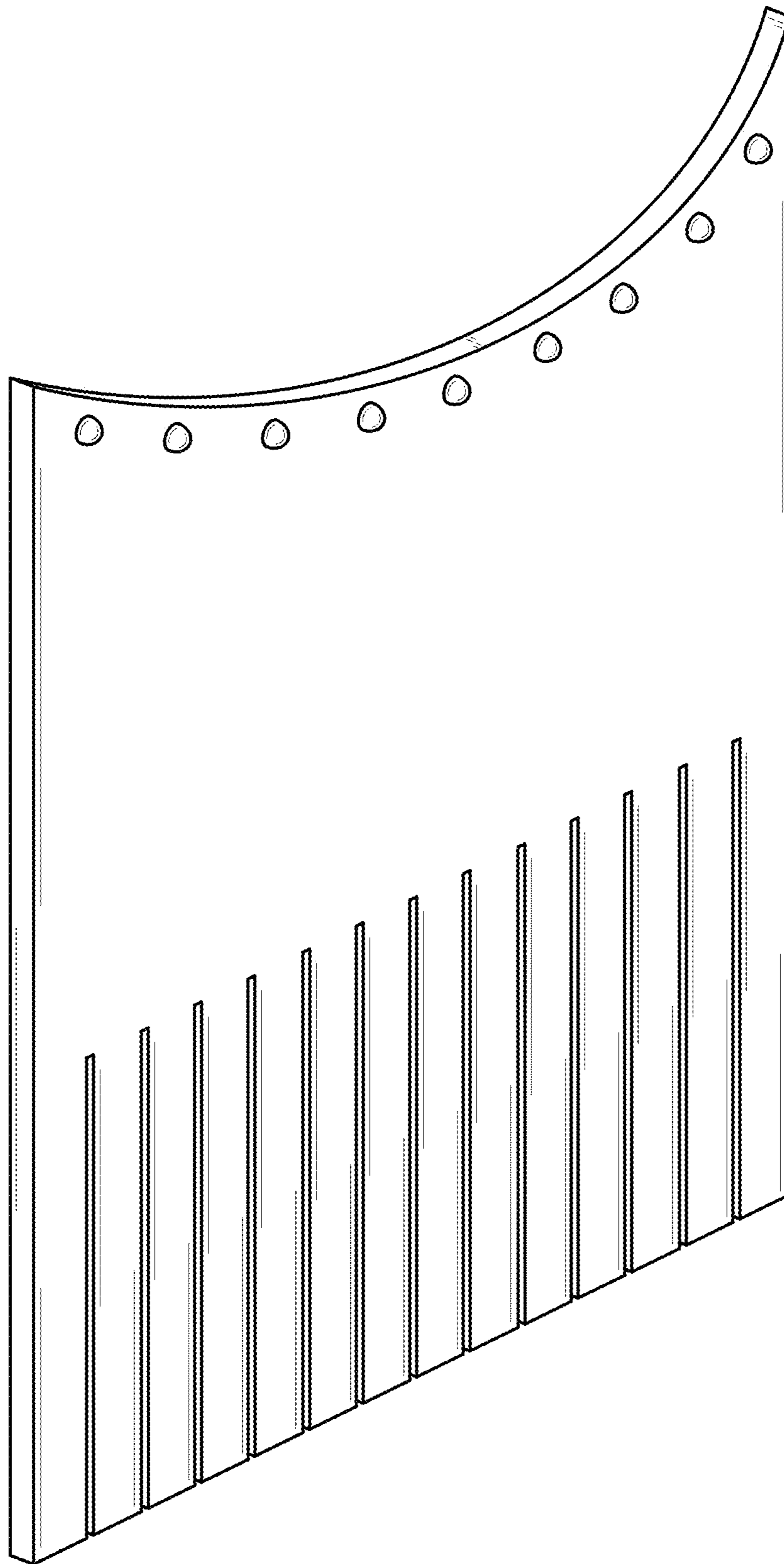

FIG. 8

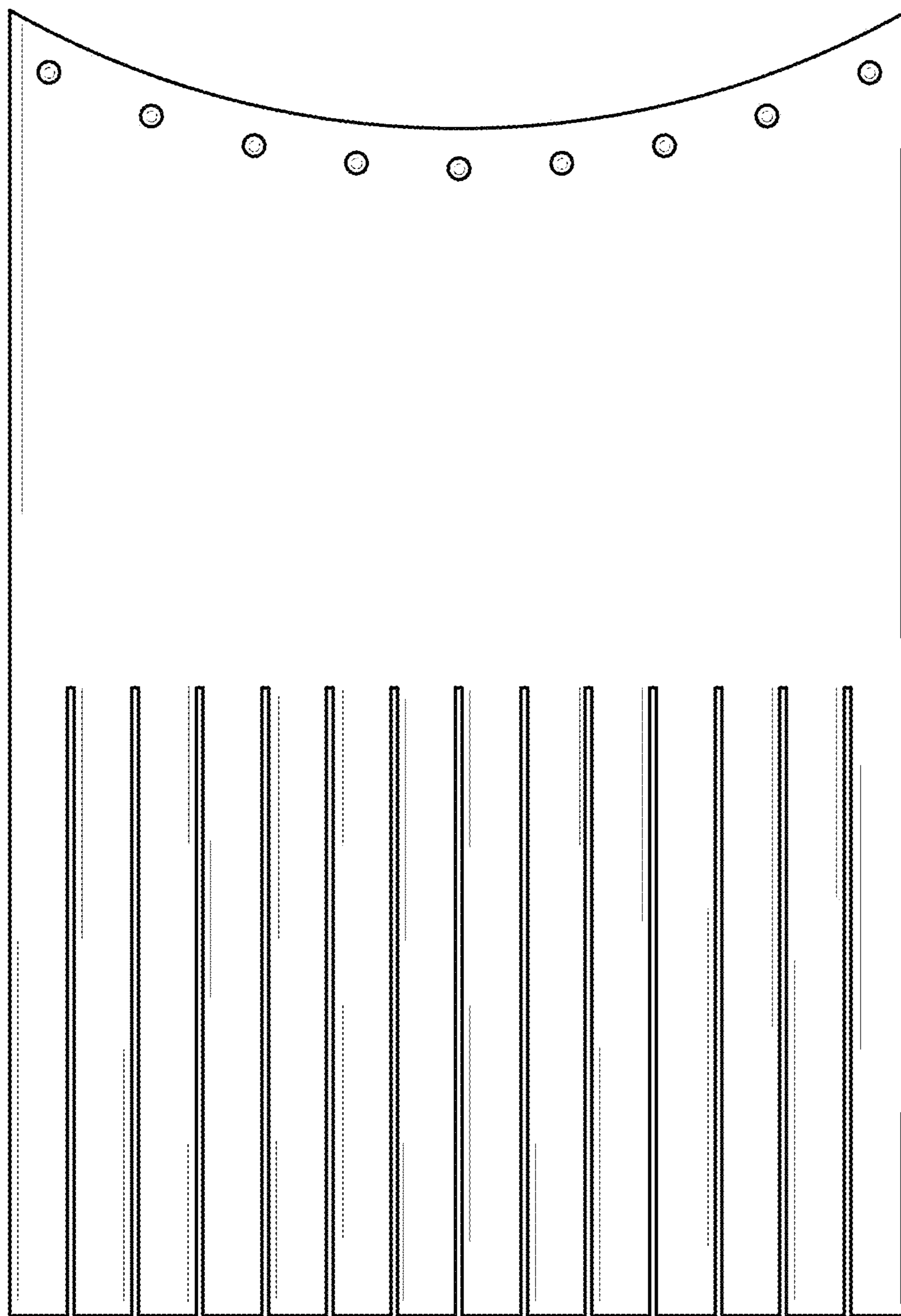

FIG. 9

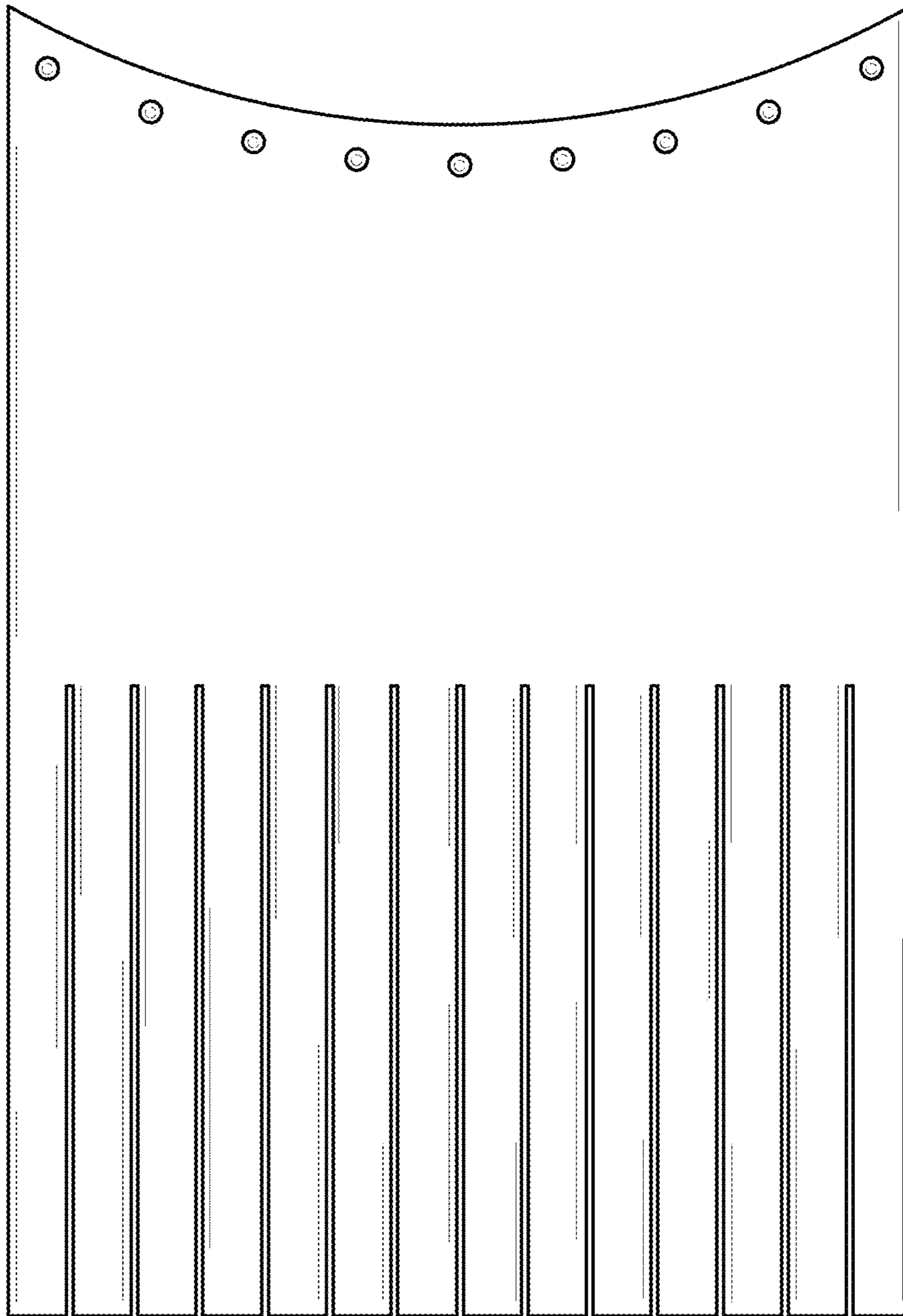

FIG. 10

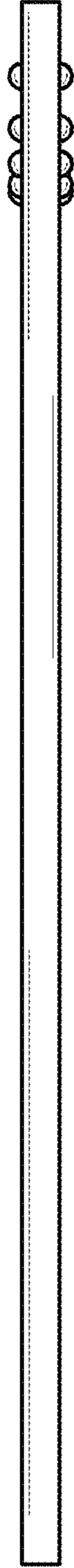

FIG. 11

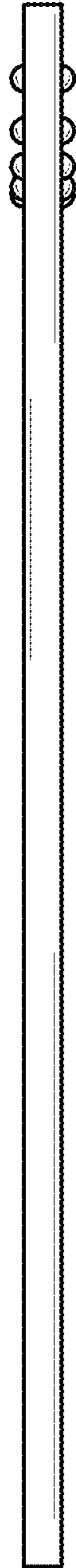

FIG. 12

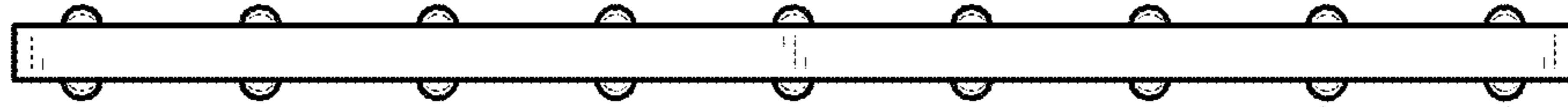

FIG. 13



FIG. 14

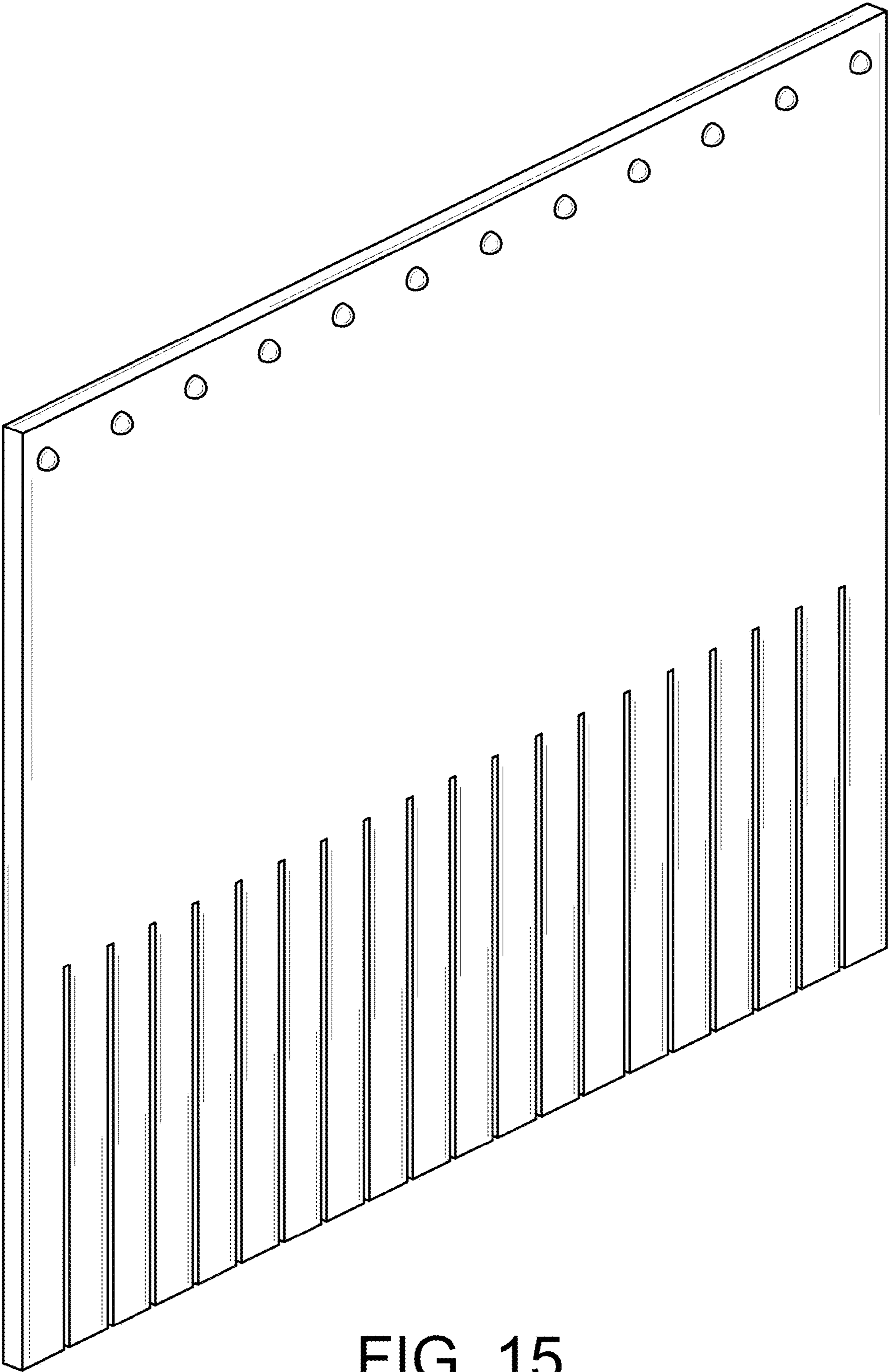

FIG. 15

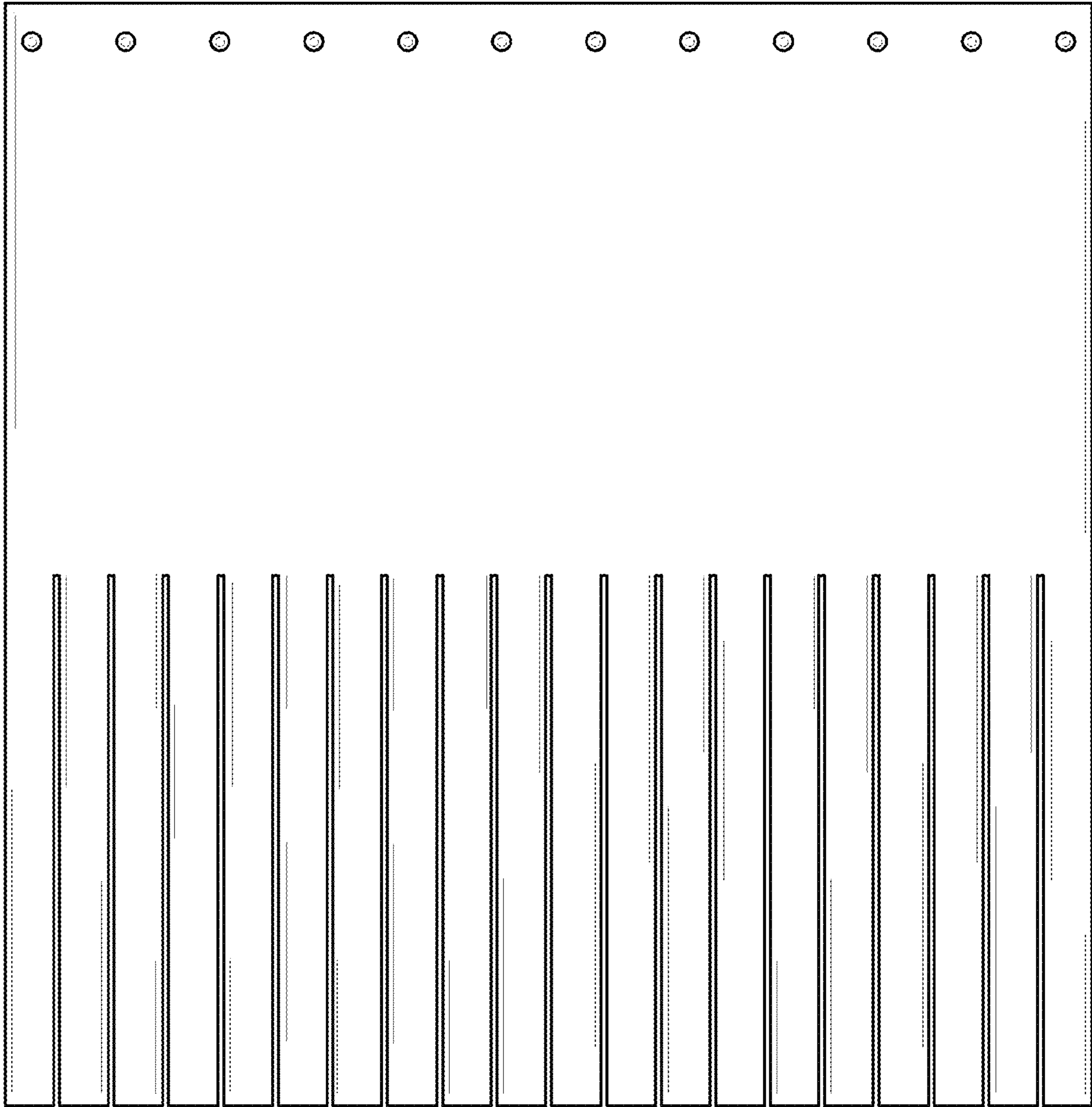

FIG. 16



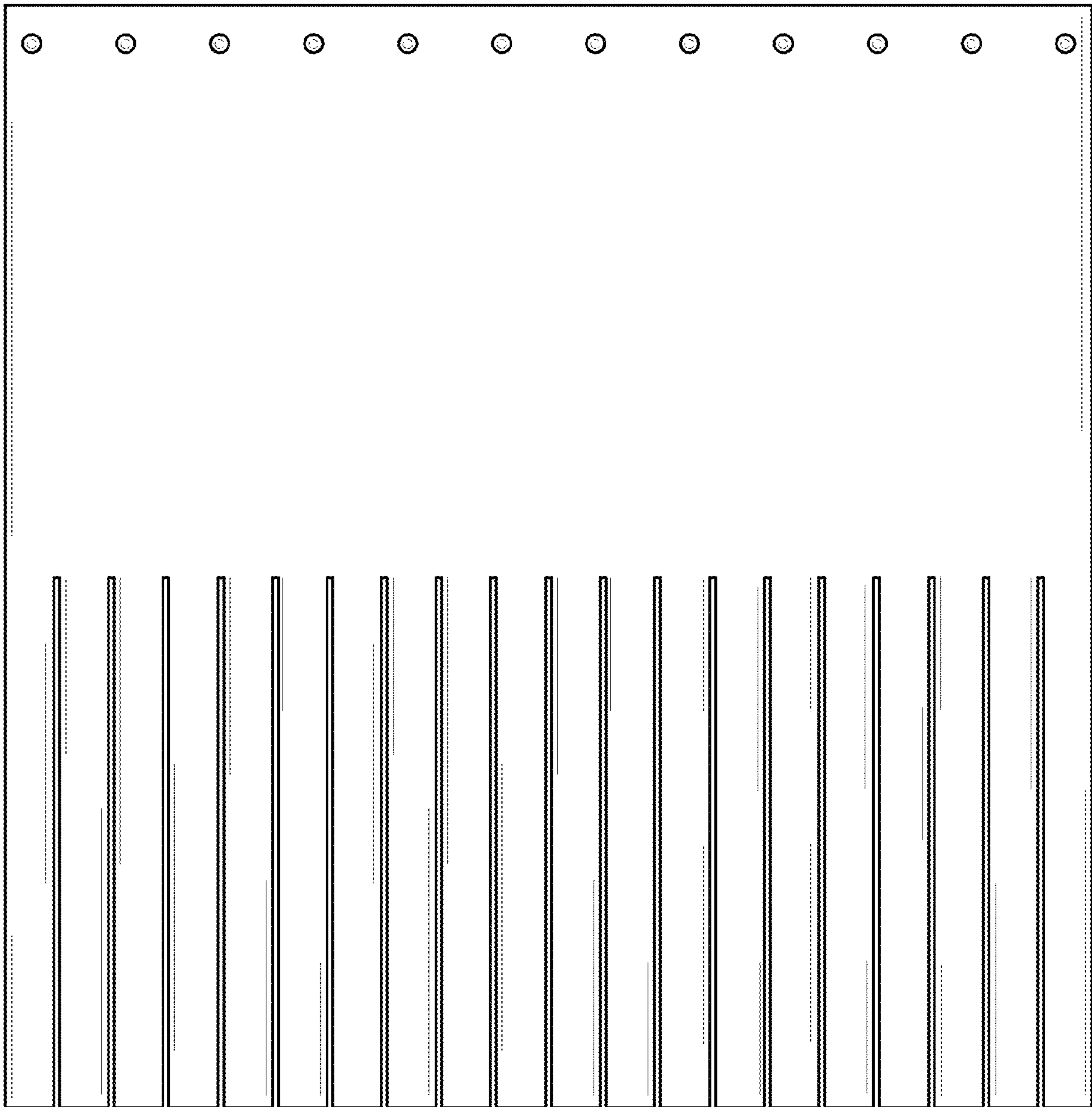

FIG. 17

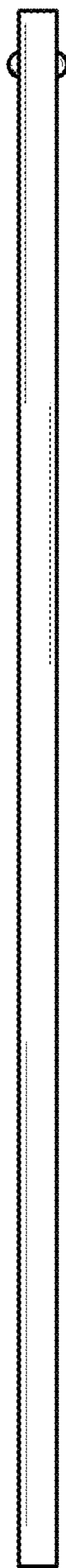

FIG. 18

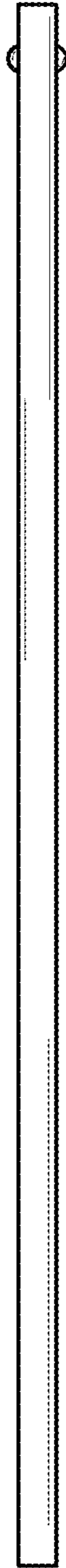

FIG. 19

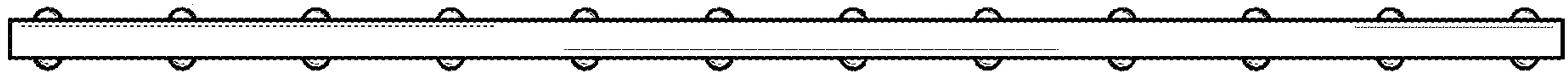

FIG. 20



FIG. 21