



US00D958969S

(12) **United States Design Patent** (10) **Patent No.:** **US D958,969 S**
Prentice et al. (45) **Date of Patent:** **** Jul. 26, 2022**

(54) **FACE MASK FRAME**

(56) **References Cited**

(71) Applicant: **Fisher & Paykel Healthcare Limited**,
Auckland (NZ)

U.S. PATENT DOCUMENTS

(72) Inventors: **Craig Robert Prentice**, Auckland (NZ);
Bernard Tsz Lun Ip, Auckland (NZ);
Mark Arvind McLaren, Auckland
(NZ); **Kyle Gregory Brown**, Auckland
(NZ); **Chris Onin Limpin Hipolito**,
Auckland (NZ); **Mark Richard**
Tomlinson, Auckland (NZ); **Melissa**
Catherine Bornholdt, Auckland (NZ)

4,522,369 A	6/1985	Ansite	
4,630,604 A	12/1986	Montesi	
D383,204 S	9/1997	Lomas et al.	
D476,407 S	6/2003	Snyder	
6,631,718 B1	10/2003	Lovell et al.	
6,691,707 B1	2/2004	Gunaratnam et al.	
6,817,362 B2	11/2004	Gelinas et al.	
D504,947 S	5/2005	McAuley et al.	
D539,901 S	4/2007	McAuliffe et al.	
7,290,546 B2	11/2007	Sprinkle et al.	
D556,899 S	12/2007	Veliss et al.	
D579,105 S	10/2008	Jones et al.	
D585,979 S *	2/2009	Stallard	D24/110.1
D591,420 S *	4/2009	Selvarajan	D24/110.1
D597,202 S	7/2009	Reid et al.	
D597,660 S *	8/2009	Maurer	G06K 7/10801 D24/110.1
D619,449 S	7/2010	Smith	
7,793,987 B1	9/2010	Busch et al.	
D637,283 S	5/2011	Selvarajan et al.	
D651,304 S	12/2011	Edwards et al.	
D656,231 S	3/2012	Henry et al.	
D673,245 S	12/2012	Cooney	
D679,376 S	4/2013	Von Hollen et al.	
D679,377 S	4/2013	Von Hollen et al.	
D679,378 S	4/2013	Von Hollen et al.	
D683,447 S	5/2013	Olsen et al.	
D691,257 S	10/2013	Siew et al.	
D692,554 S	10/2013	Siew et al.	
D693,459 S	11/2013	Prentice	
D695,887 S	12/2013	Ozolins et al.	
D696,767 S	12/2013	Scheiner et al.	
D697,203 S	1/2014	Clarke et al.	
D706,413 S	6/2014	Veliss et al.	
8,789,525 B2	7/2014	Snow	
D717,945 S	11/2014	Neff et al.	
8,950,404 B2	2/2015	Formica et al.	
D740,934 S	10/2015	Formica et al.	
9,155,855 B2	10/2015	Tebbutt	
D748,242 S	1/2016	Campbell et al.	
D751,188 S	3/2016	Skipper et al.	
D752,199 S	3/2016	Berkman	
D753,813 S	4/2016	Ozolins et al.	
D754,328 S	4/2016	Bowsher	
D757,252 S	5/2016	Von Moger et al.	
D758,564 S	6/2016	Eves et al.	
D764,049 S	8/2016	Cullen et al.	
D767,750 S	9/2016	Nakai et al.	
D769,440 S	10/2016	Amarasinghe et al.	

(73) Assignee: **Fisher & Paykel Healthcare Limited**,
Auckland (NZ)

(*) Notice: This patent is subject to a terminal dis-
claimer.

(**) Term: **15 Years**

(21) Appl. No.: **29/654,233**

(22) Filed: **Jun. 21, 2018**

Related U.S. Application Data

(63) Continuation of application No. 29/595,877, filed on
Mar. 2, 2017, now Pat. No. Des. 824,021, which is a
continuation of application No. 29/540,693, filed on
Sep. 25, 2015, now Pat. No. Des. 784,516.

(51) **LOC (13) Cl.** **29-02**

(52) **U.S. Cl.**
USPC **D24/110.4**

(58) **Field of Classification Search**
USPC D24/110-110.5, 127, 164
CPC A61M 16/0605; A61M 16/0622; A61M
16/06; A61M 16/0616; A61M 16/0661;
A61M 16/0633; A61M 16/0644; A61M
16/0816; A61M 16/08; A61M 16/0666;
A61M 2210/0618; A61M 16/0683

See application file for complete search history.

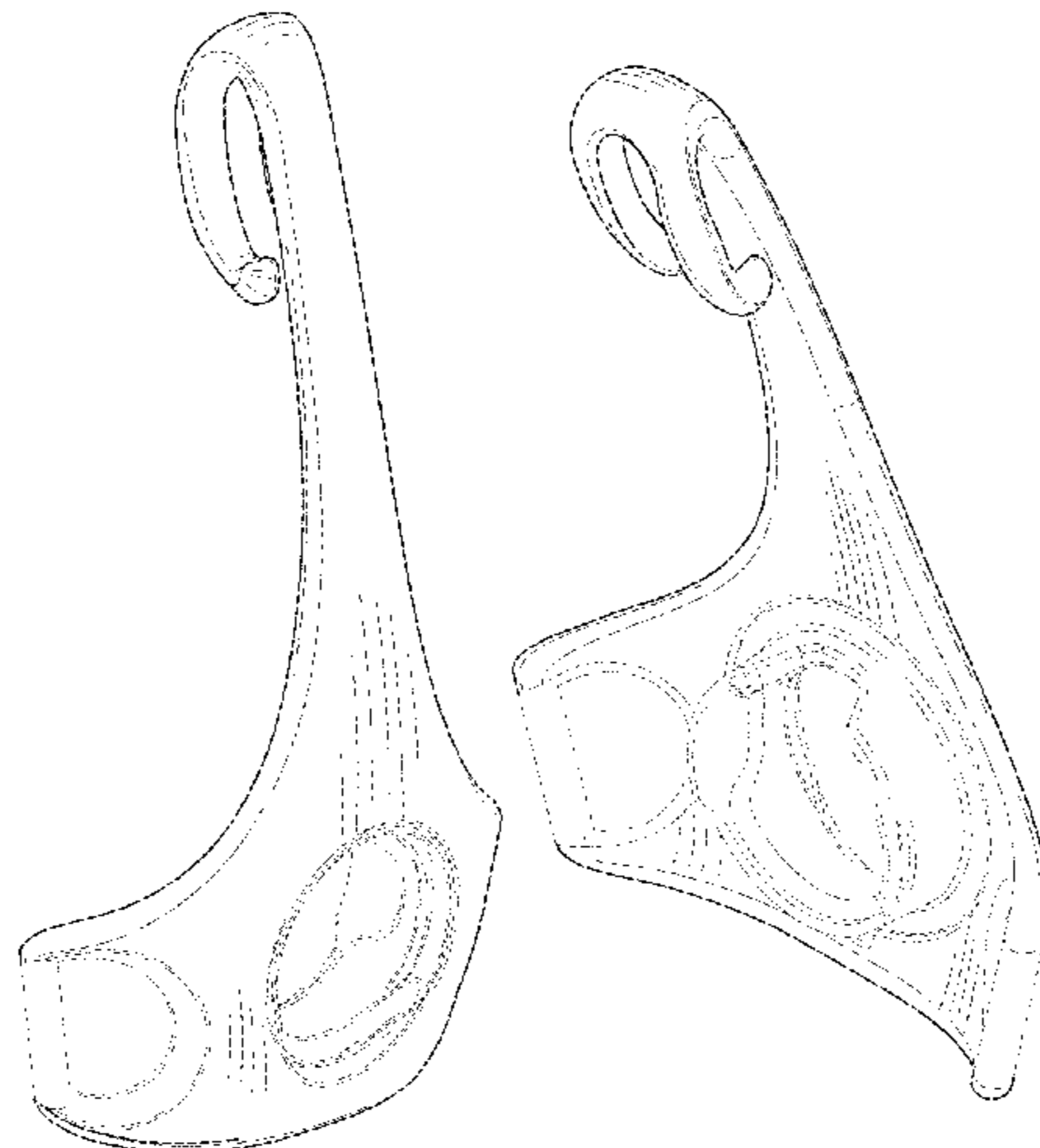

OTHER PUBLICATIONS

Fisher & Paykel Announces Eson 2 Mask at Investor Day. Sleep Review. Oct. 12, 2015. <<http://www.sleepreviewmag.com/2015/10/fisher-paykel-announces-eson-2-mask-investor-day/>>.

New—Eson 2 Fisher & Paykel Nasal Mask. CPAP Victoria: Snoring & Sleep Apnoea Solutions, cpapvictoria.com.au. Date accessed: May 21, 2016. <<http://cpapvictoria.com.au/new-eson-2-fisher-paykel-nasal-mask.html>>.

Fisher & Paykel Eson 2 Nasal Mask. CPAP Direct, cpapdirect.com.au. Date accessed: May 21, 2016. <<https://cpapdirect.com.au/wp-content/uploads/2-15/12/Eson2-Exploded-Image.jpg>>.

Swivel for Fisher Paykel Eson2 Nasal Mask #400FPH241. CPAP Australia. www.cpapaustralia.com.au. Date accessed: May 21, 2016. <<https://www.cpapaustralia.com.au/shopping/swivel-for-fisher-paykel-eson2-nasal-mask-400fph241.html>>.

Office Action for U.S. Appl. No. 29/540,662 dated May 19, 2016.

Office Action for U.S. Appl. No. 29/540,681 dated May 19, 2016.

Office Action for U.S. Appl. No. 29/540,693 dated Jun. 2, 2016.

Office Action for U.S. Appl. No. 29/540,684 dated Sep. 15, 2016.

Office Action for U.S. Appl. No. 29/540,680 dated Jun. 2, 2016.

S-1225, image postdate Jul. 30, 2017, site visited Nov. 24, 2017, (online), <https://www.tineye.com/search/5a303183b2900291d1429fe660f391f2c1a0f159/?sort=crawl_date&order=asc>.

Direct-home-medical-parts-for-cpap-masks-bipap-masks, image post date Sep. 27, 2017, site visited Nov. 24, 2017, (online), <<https://www.tineye.com/search/58ef6f11e162268d500494d731e8e5c6c671dc48/>>.

F&P Eson 2 Nasal CPAP Mask Pack with Headgear, image post date Nov. 20, 2016, site visited Nov. 24, 2017, (online), <<http://www.directhomemedical.com/eson-2-nasal-cpap-mask-fisher-paykel-healthcare.html#reviews>>.

* cited by examiner

Primary Examiner — Mary Shannon Malley

Assistant Examiner — Lee D. Starr

(74) *Attorney, Agent, or Firm* — Knobbe Martens Olson & Bear LLP

(57)

CLAIM

The ornamental design for a face mask frame, as shown and described.

DESCRIPTION

FIG. 1 is a top, front, and side perspective view of a face mask frame showing our new design;

FIG. 2 is a top, rear and side perspective view thereof;

FIG. 3 is a front view thereof;

FIG. 4 is a rear view thereof;

FIG. 5 is a first side view thereof;

FIG. 6 is a second side view thereof;

FIG. 7 is a top view thereof; and,

FIG. 8 is a bottom view thereof.

The dash-dot-dash broken lines define the bounds of the claimed design and form no part thereof. The dash-dash broken lines illustrate portions of the face mask frame that form no part of the claimed design.

1 Claim, 7 Drawing Sheets

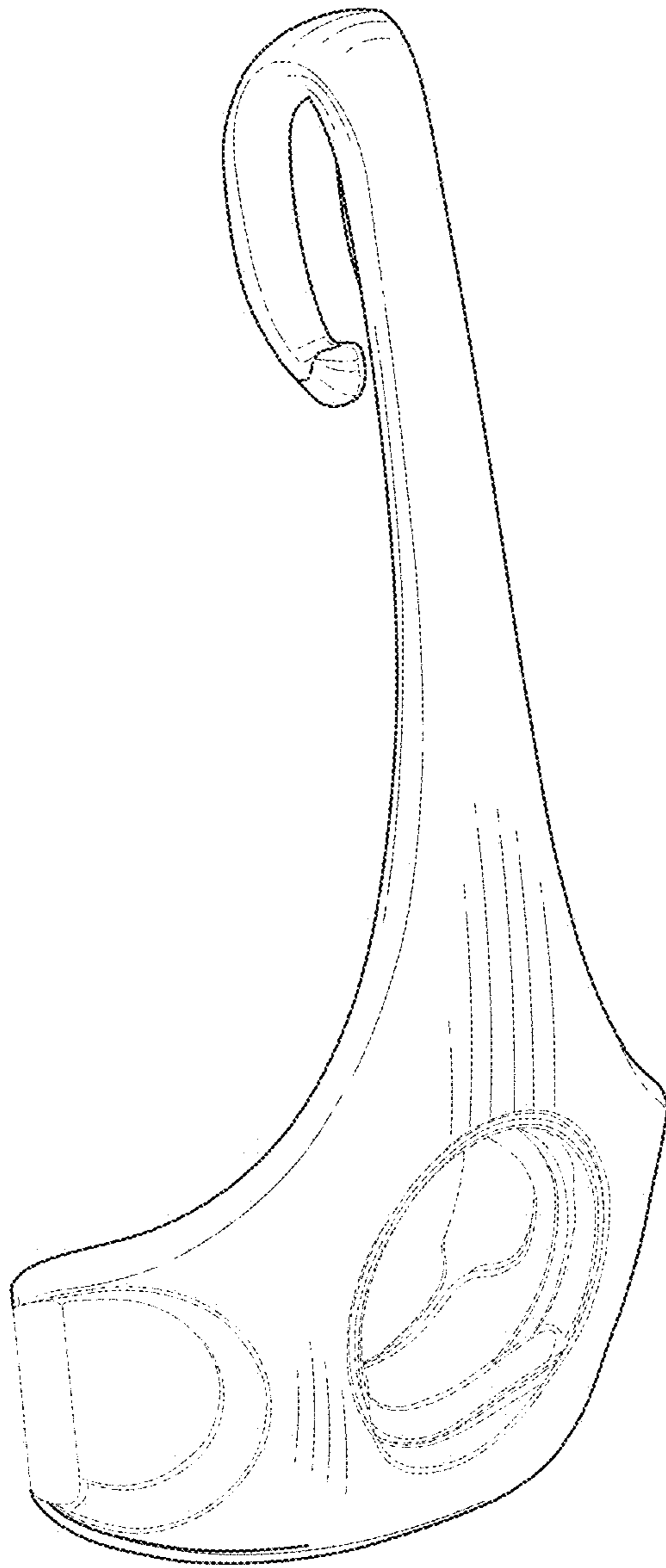

FIG. 1

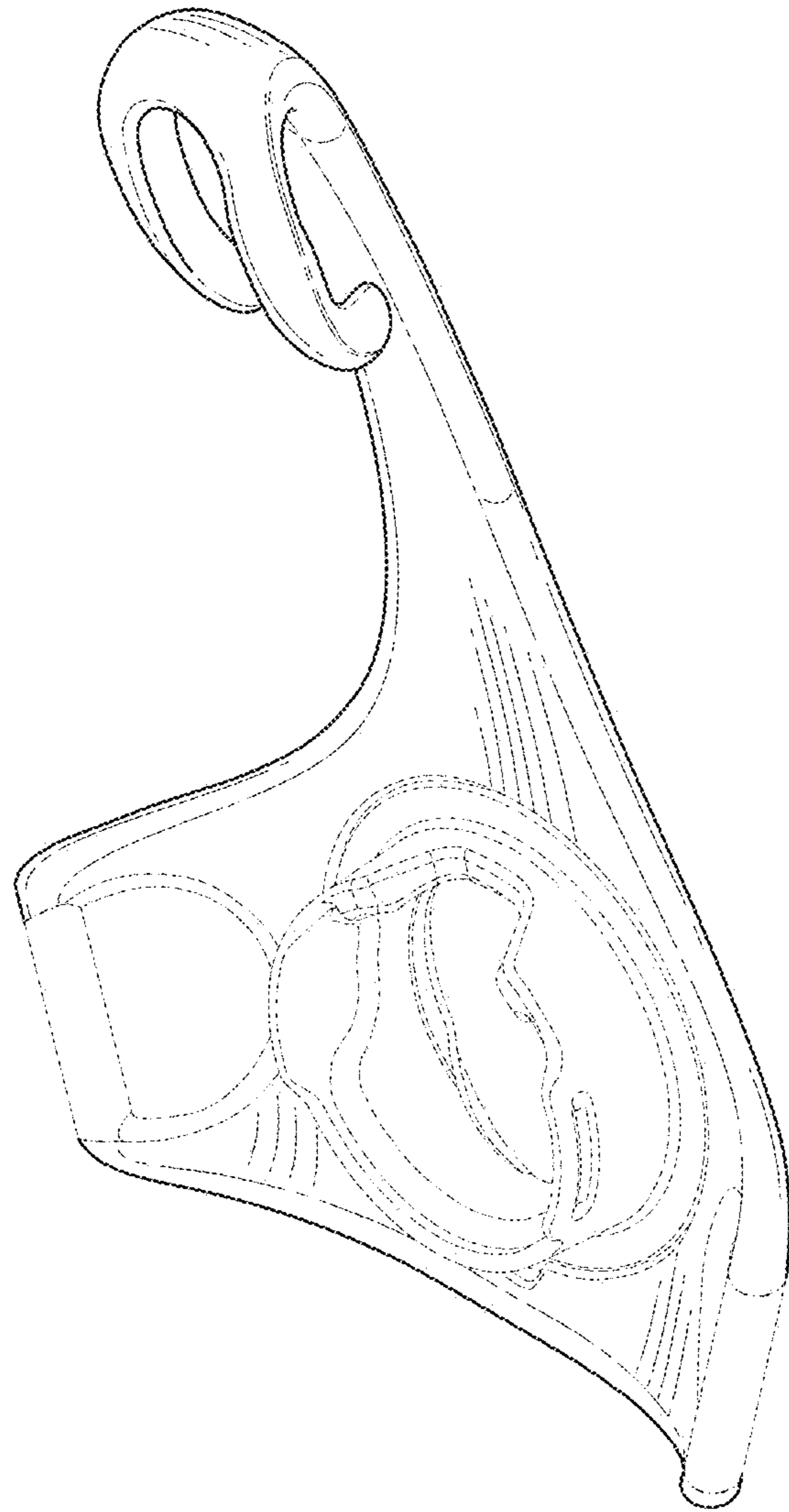

FIG. 2

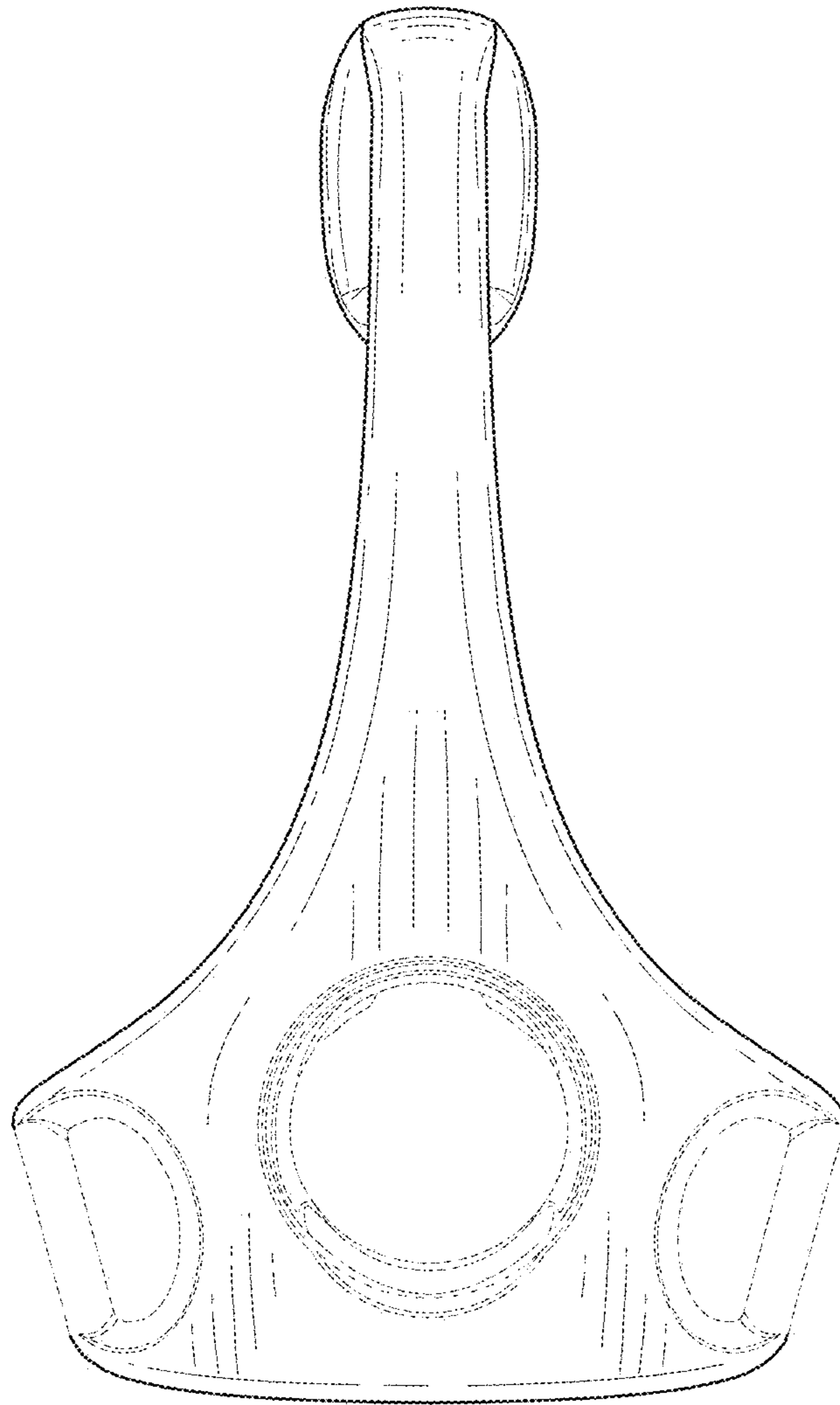

FIG. 3

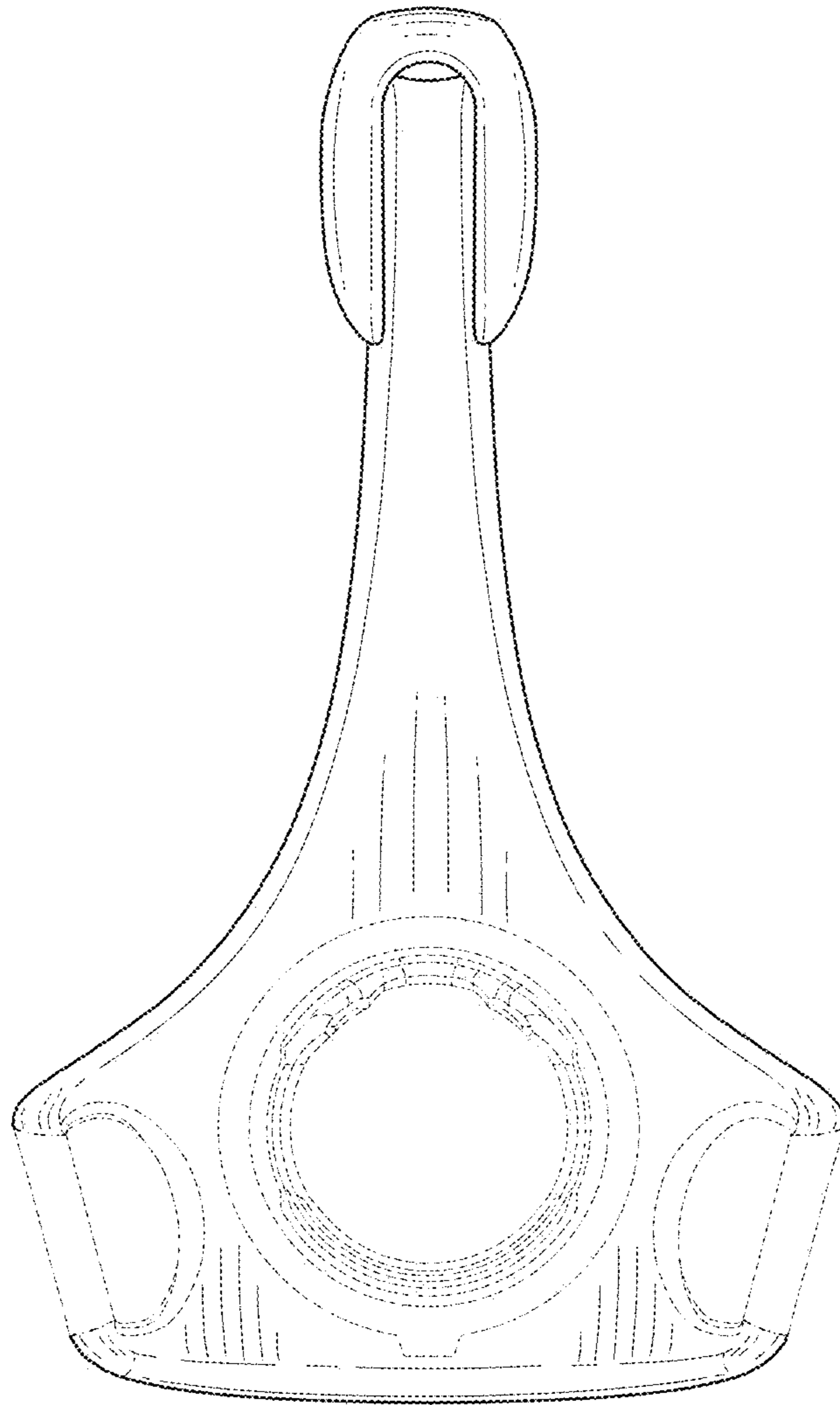

FIG. 4

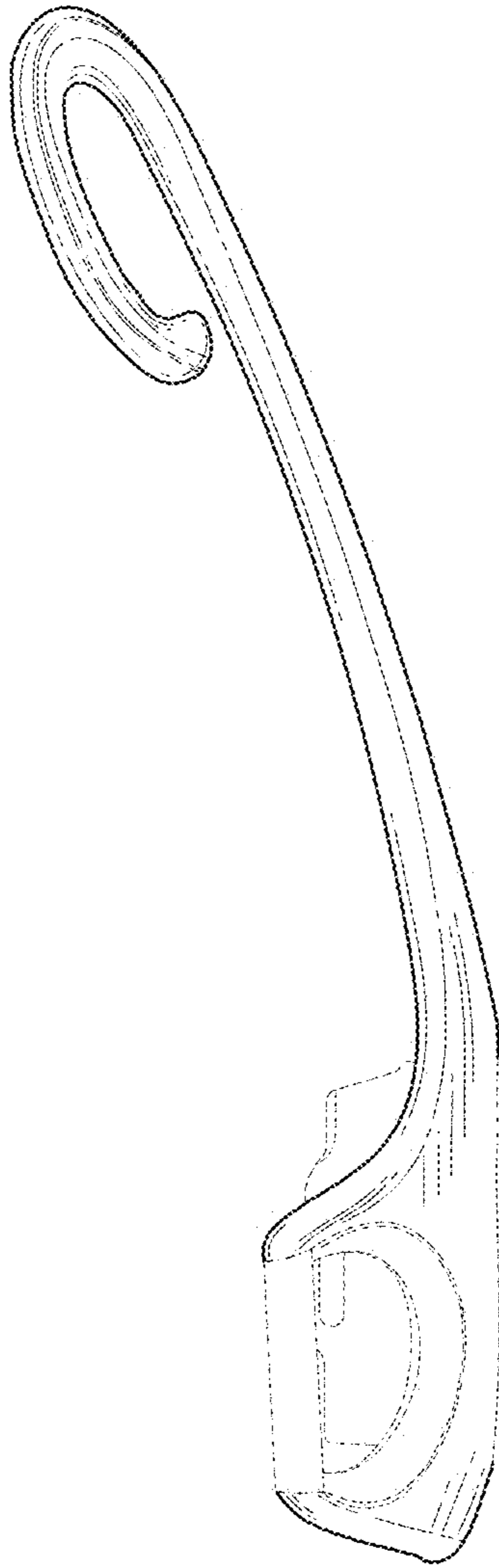

FIG. 5

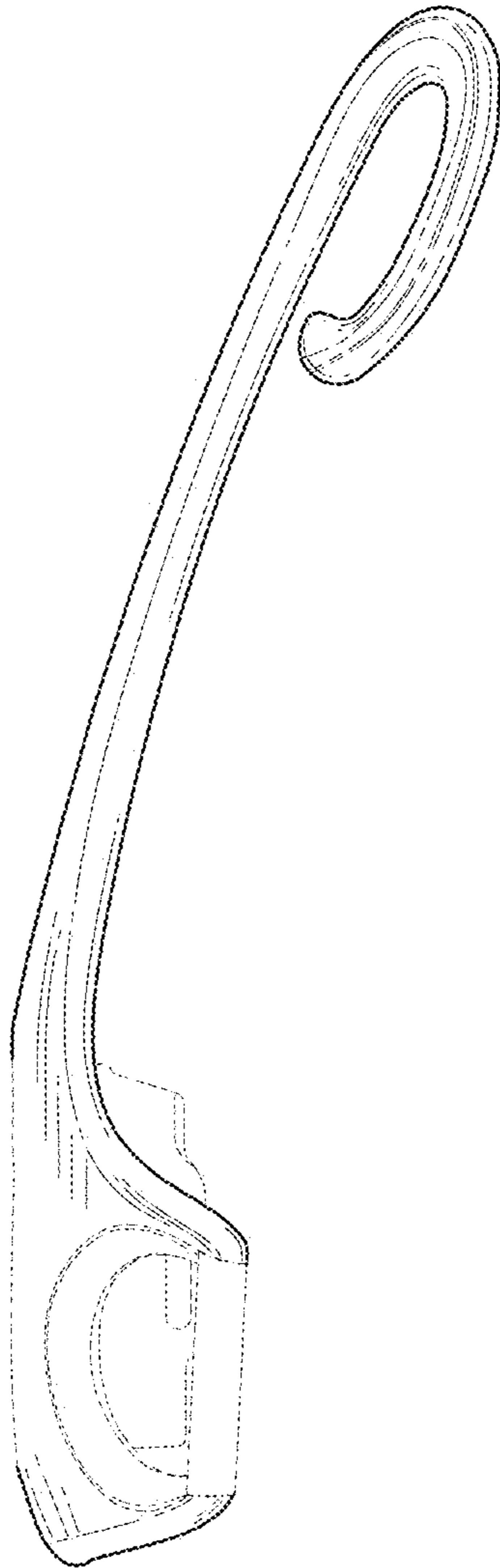

FIG. 6

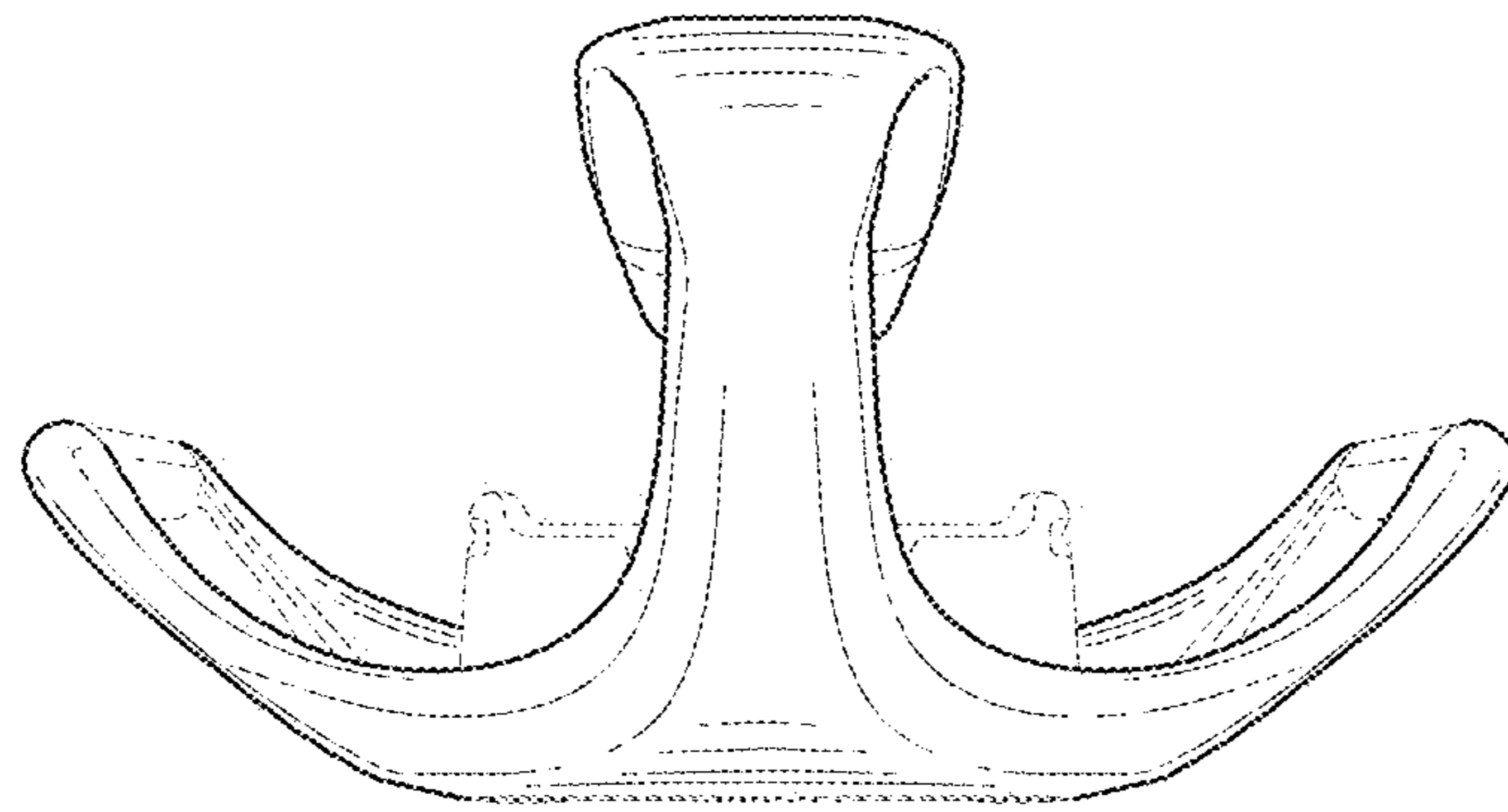

FIG. 7

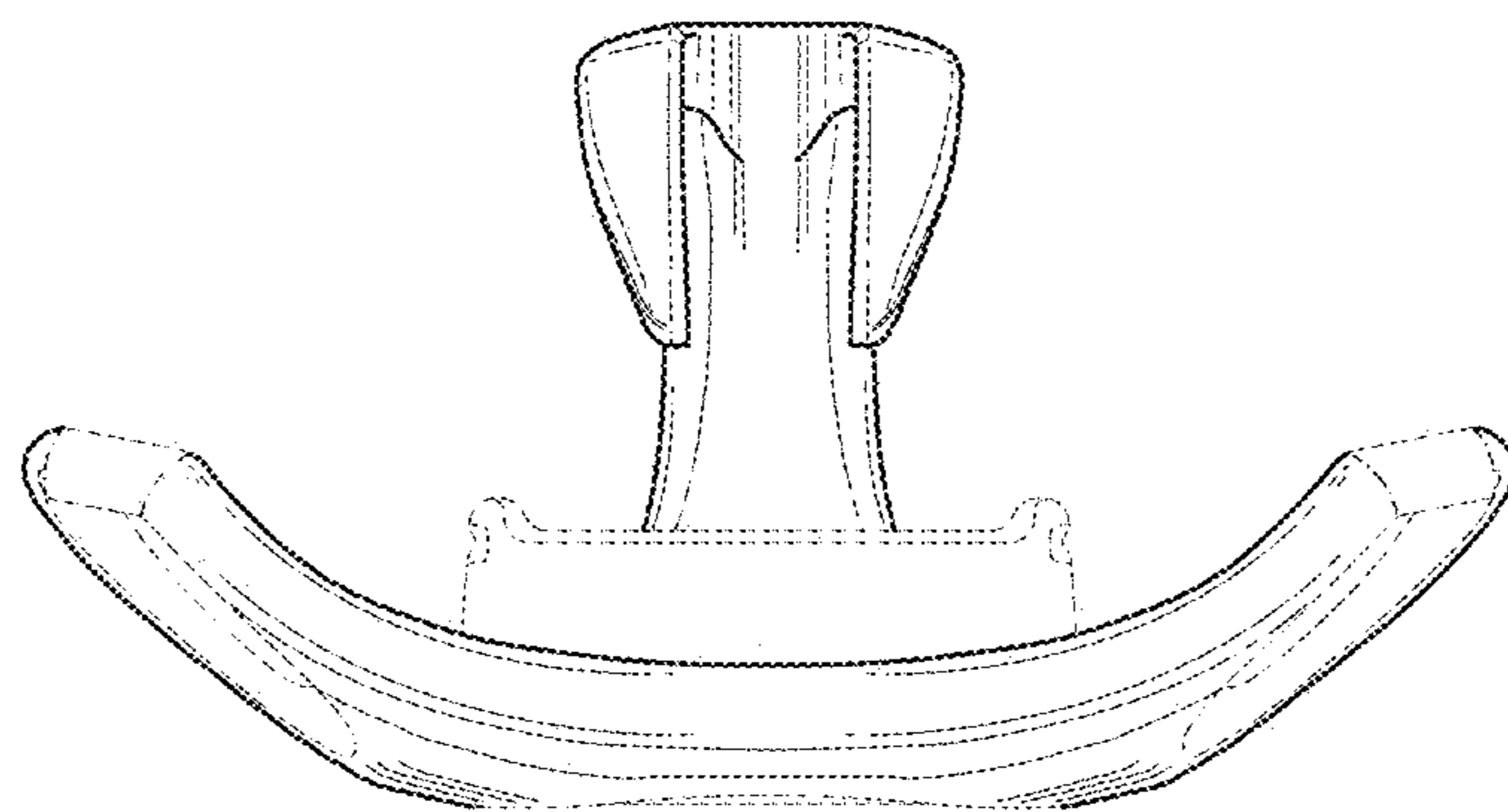

FIG. 8