



US00D958958S

(12) **United States Design Patent** (10) **Patent No.:** **US D958,958 S**
Yang (45) **Date of Patent:** **** Jul. 26, 2022**

(54) **DIFFUSER**

(71) Applicant: **GUIZHOU VINMAN INDUSTRIAL CO., LIMITED**, Guizhou (CN)

(72) Inventor: **Zaimao Yang**, Guizhou (CN)

(73) Assignee: **GUIZHOU VINMAN INDUSTRIAL CO., LIMITED**, Guizhou (CN)

(**) Term: **15 Years**

(21) Appl. No.: **29/761,317**

(22) Filed: **Dec. 8, 2020**

(30) **Foreign Application Priority Data**

Jun. 8, 2020 (CN) 202030285269.5

(51) **LOC (13) Cl.** **23-04**

(52) **U.S. Cl.**
USPC **D23/366**

(58) **Field of Classification Search**

USPC D7/509, 510; D11/143, 152; D14/195, D14/204, 221, 228, 242; D23/207, 208, D23/209, 213, 223, 333, 335, 336, 342, D23/351, 352, 353, 355, 356, 359, 360, D23/362, 364-366, 370; D24/108, 112, D24/129, 206; D26/26, 37, 40, 46, 49
CPC F24F 6/00; F24F 6/06; F24F 6/12; F24F 6/14; F24F 1/00; F24F 1/01; F24F 1/02; F24F 1/022; F24F 7/065; A47G 7/06; A61M 11/02; A61M 11/041; A61L 9/01; A61L 9/00; A61L 9/03; A61L 9/12; A61L 9/122; A61L 2209/11; A61L 2209/14; A61L 2209/133; Y10S 261/17; Y10S 261/88; Y10S 261/89; B01D 46/10; B01D 46/0005; B01D 46/2411

See application file for complete search history.

(56) **References Cited**

U.S. PATENT DOCUMENTS

D810,261 S	*	2/2018	Chen	D23/366
D811,570 S	*	2/2018	Tang	D23/356
D813,367 S	*	3/2018	Situ	D23/366
D836,188 S	*	12/2018	Li	D23/356
D859,626 S	*	9/2019	Hu	D23/366
D885,548 S	*	5/2020	Cui	D23/366
D897,512 S	*	9/2020	Wu	D23/356
D939,070 S	*	12/2021	Yang	D23/356

* cited by examiner

Primary Examiner — Gino Colan

Assistant Examiner — David OBrien

(74) *Attorney, Agent, or Firm* — ScienBiziP, P.C.

(57) **CLAIM**

The ornamental design for a diffuser, as shown and described.

DESCRIPTION

FIG. 1 is a top and front perspective view of a diffuser, showing my design.
FIG. 2 is a front elevation view thereof.
FIG. 3 is a rear elevation view thereof.
FIG. 4 is a left side elevation thereof.
FIG. 5 is a right side elevation thereof.
FIG. 6 is a top plan view thereof.
FIG. 7 is a bottom plan view thereof; and,
FIG. 8 is an enlarged view of an area labeled 8 in FIG. 1.
The broken lines shown in the drawings are included for the purpose of illustrating portions of the diffuser that form no part of the claimed design.

1 Claim, 8 Drawing Sheets

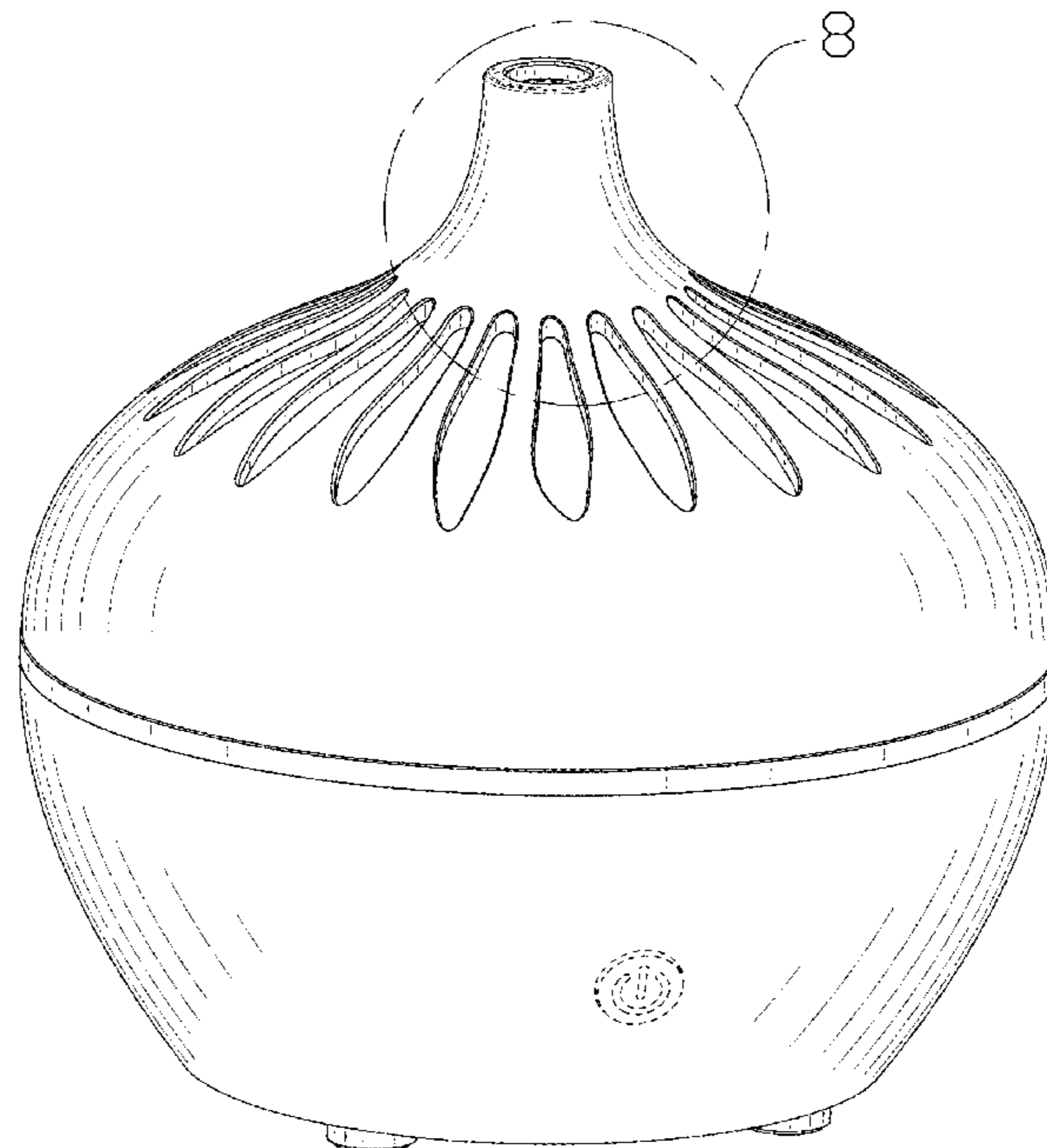

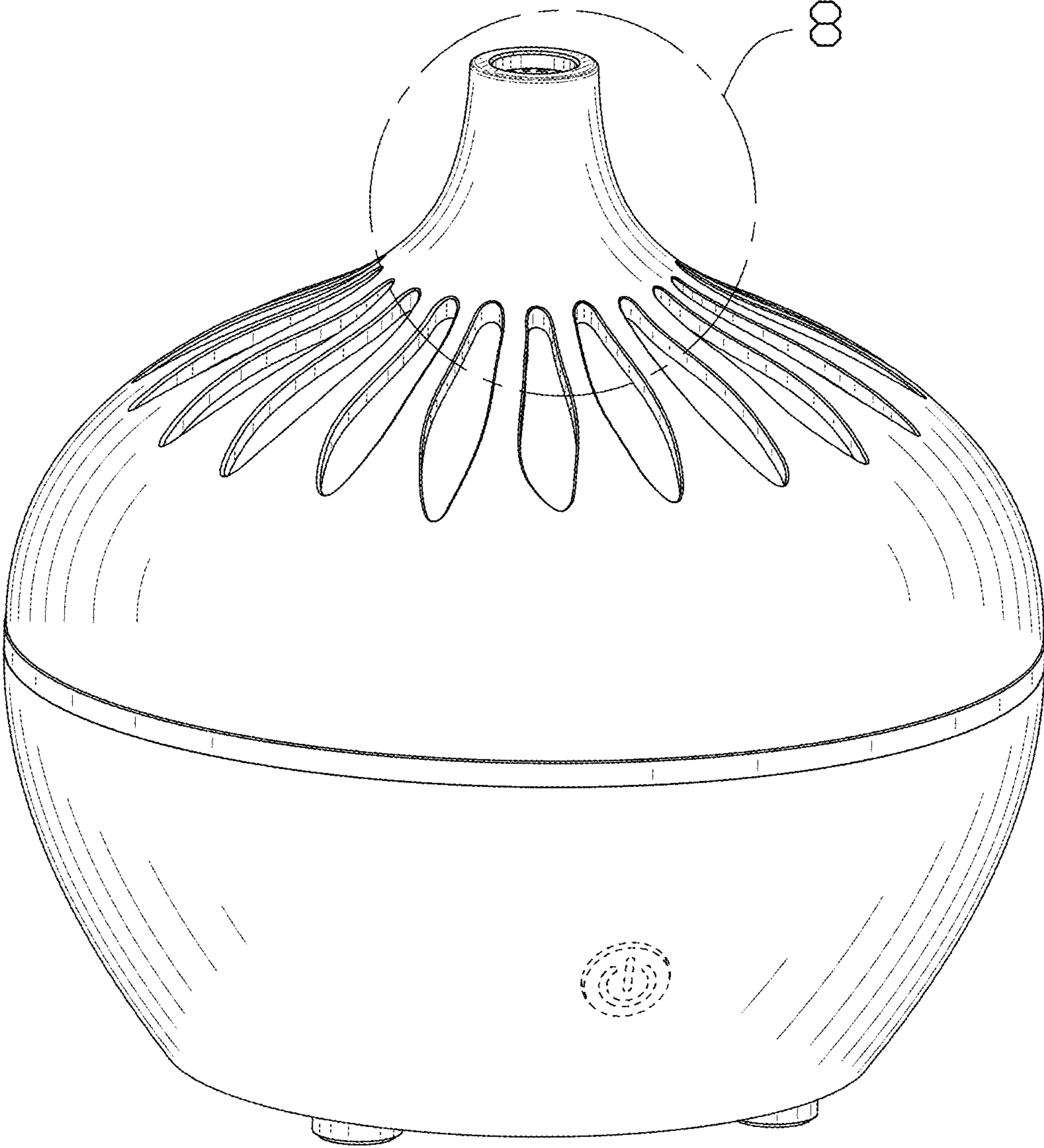

FIG. 1

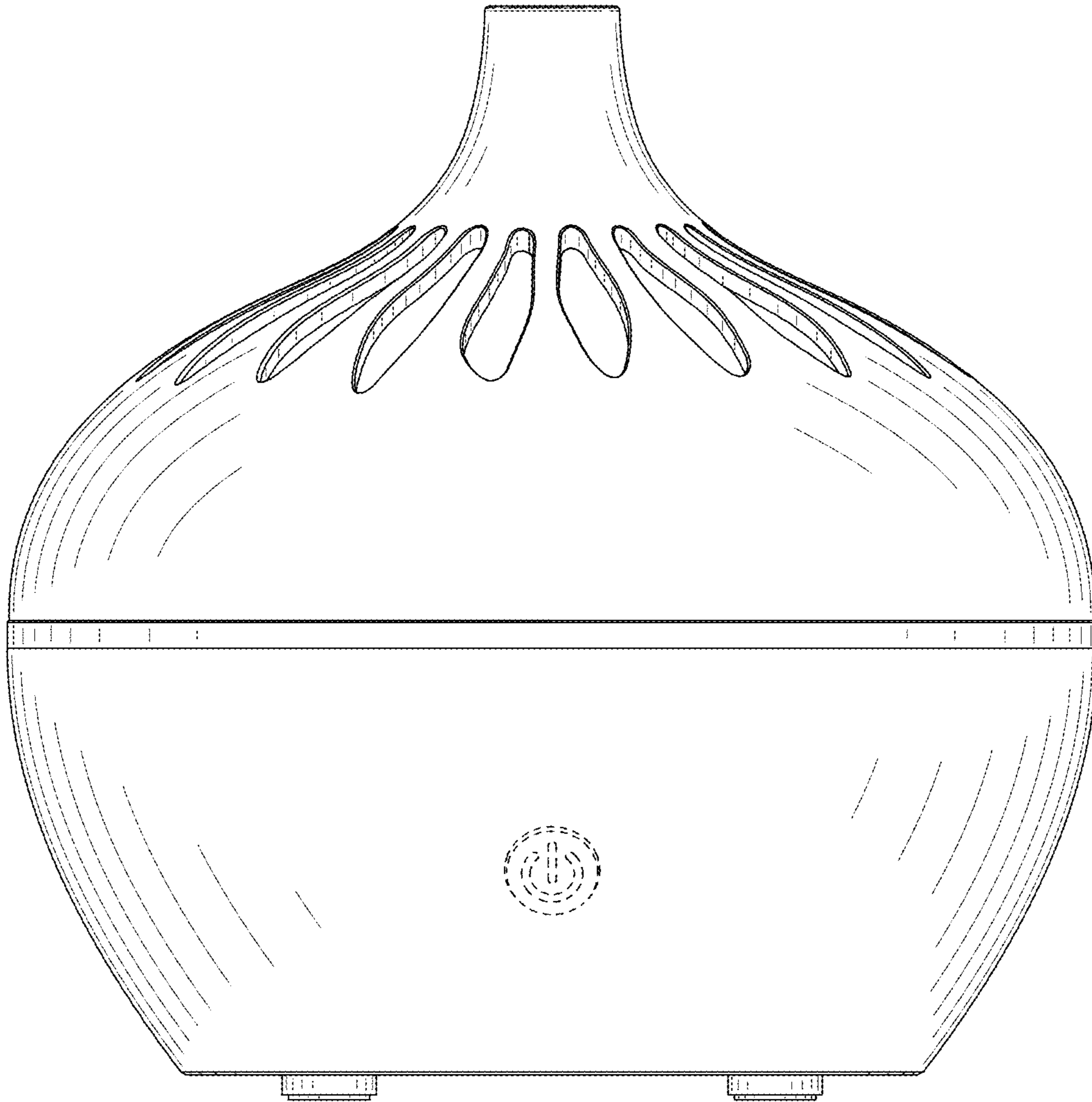

FIG. 2

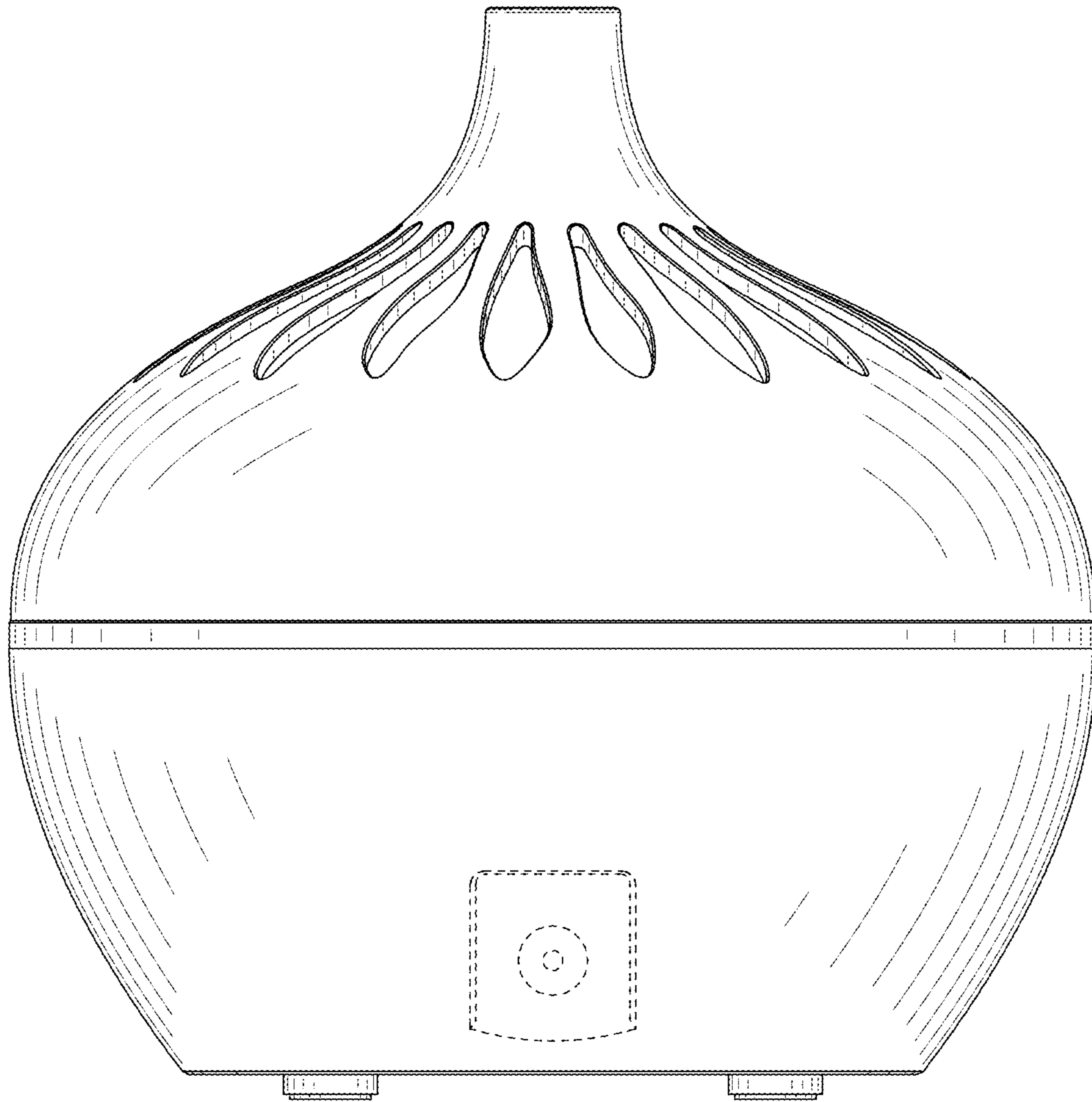

FIG. 3

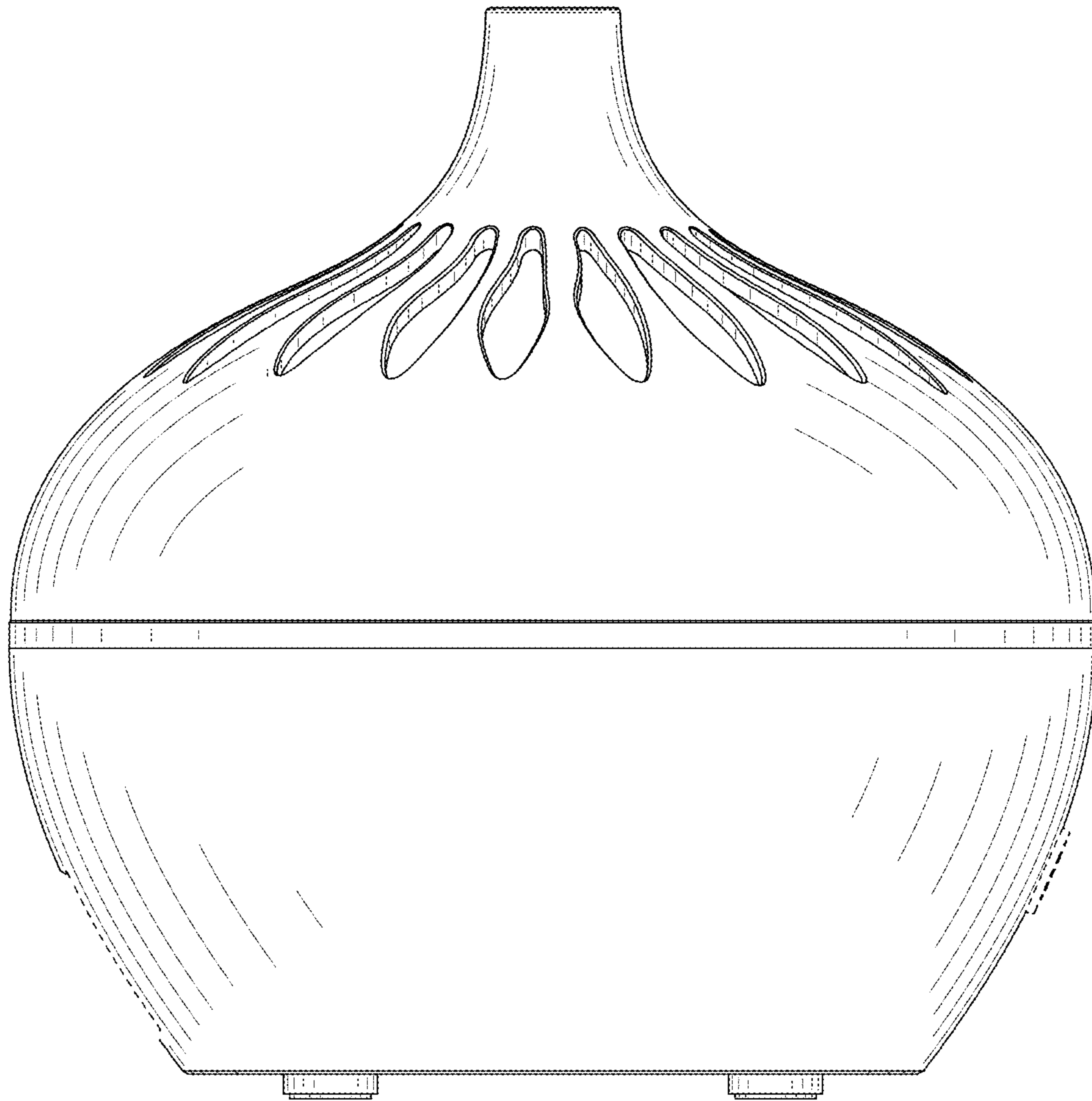

FIG. 4

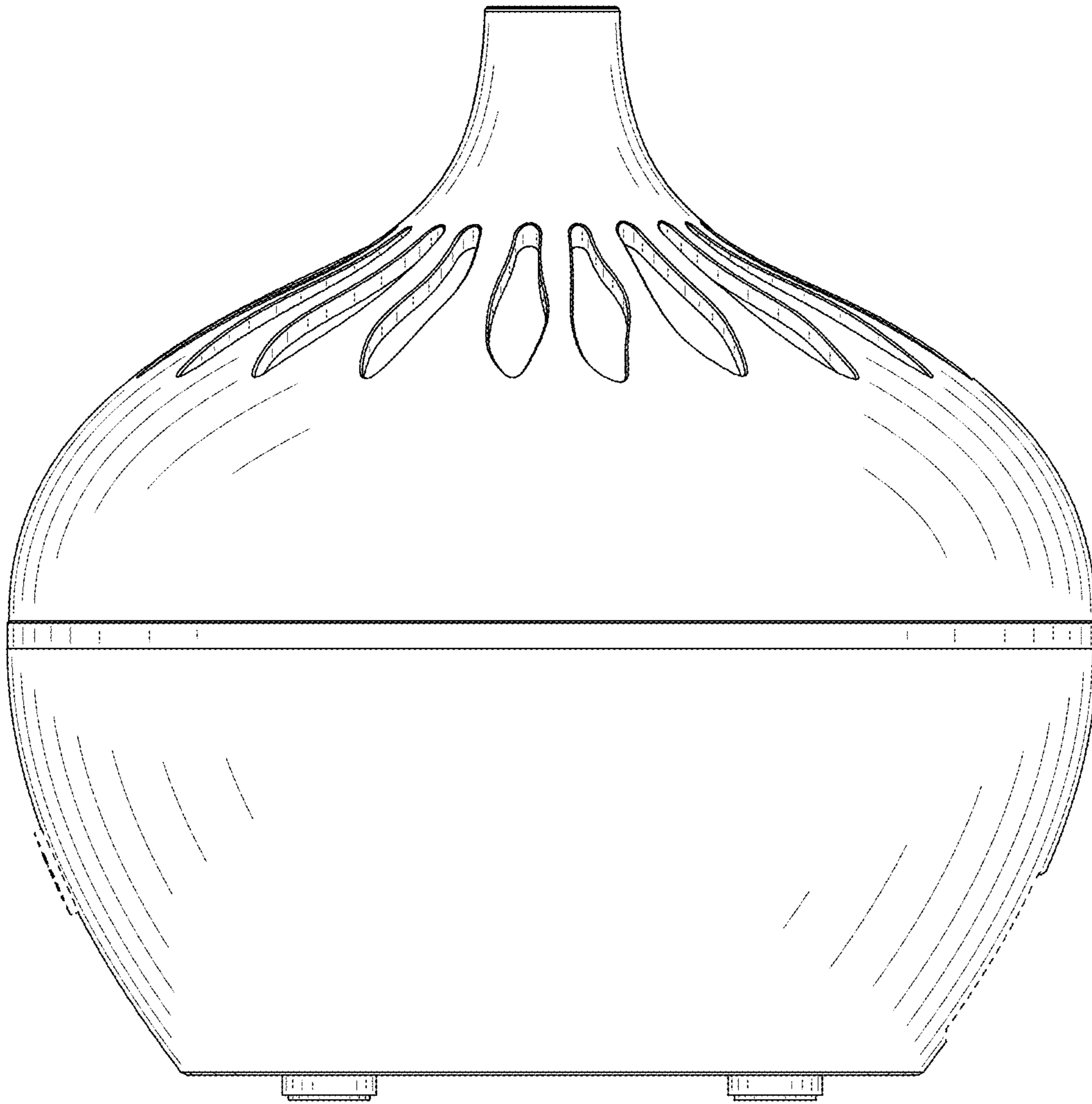

FIG. 5

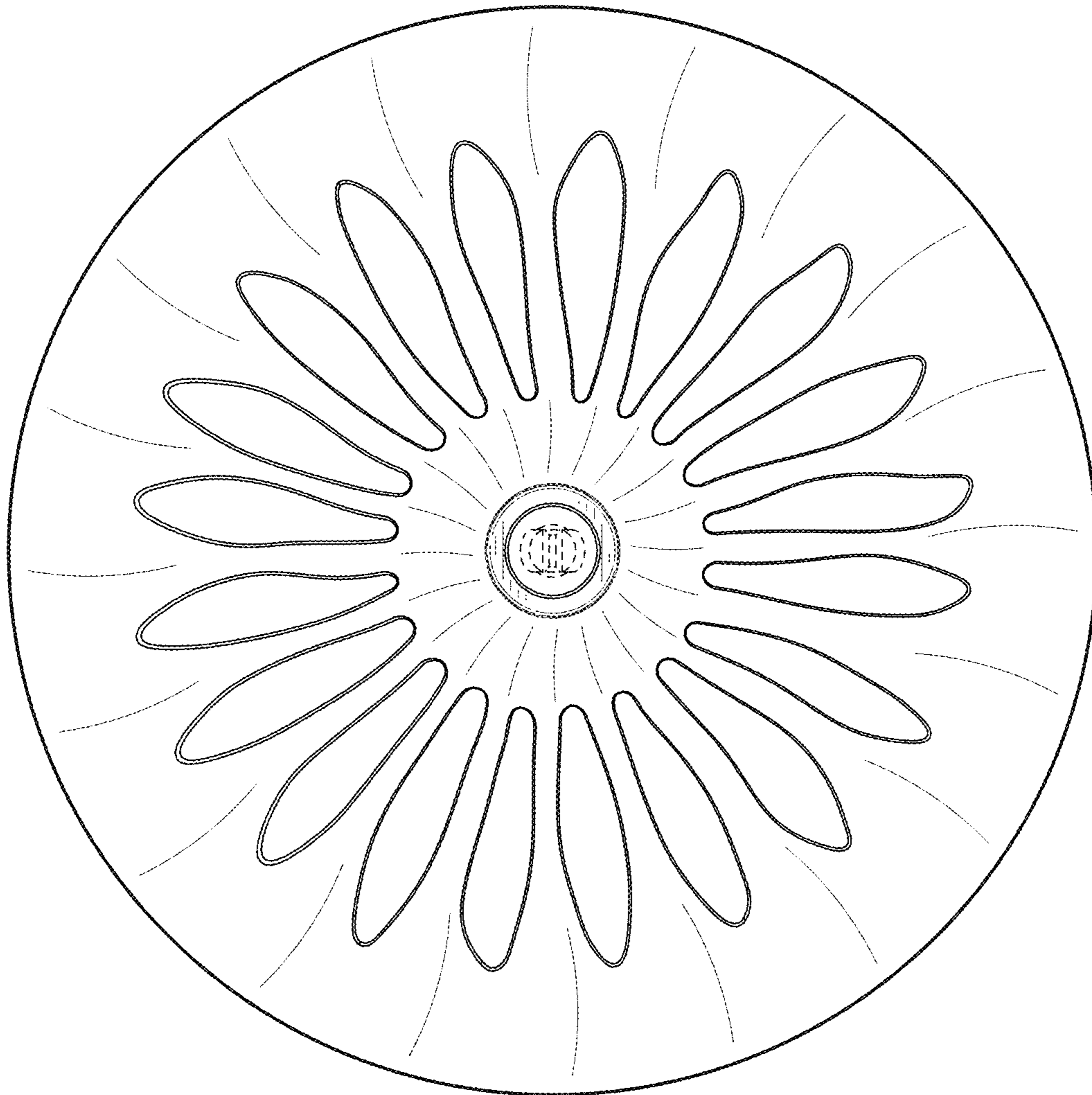

FIG. 6

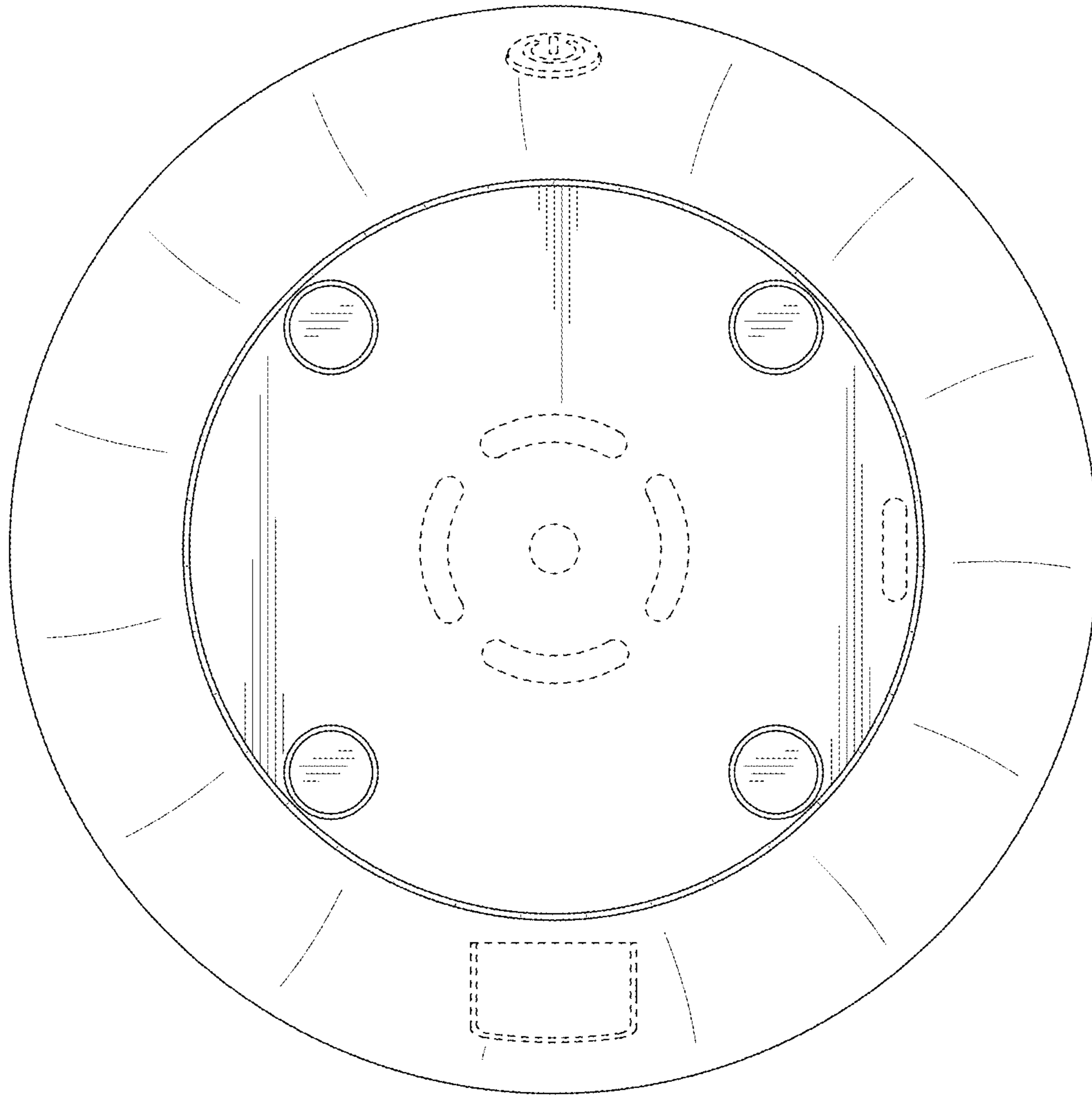

FIG. 7

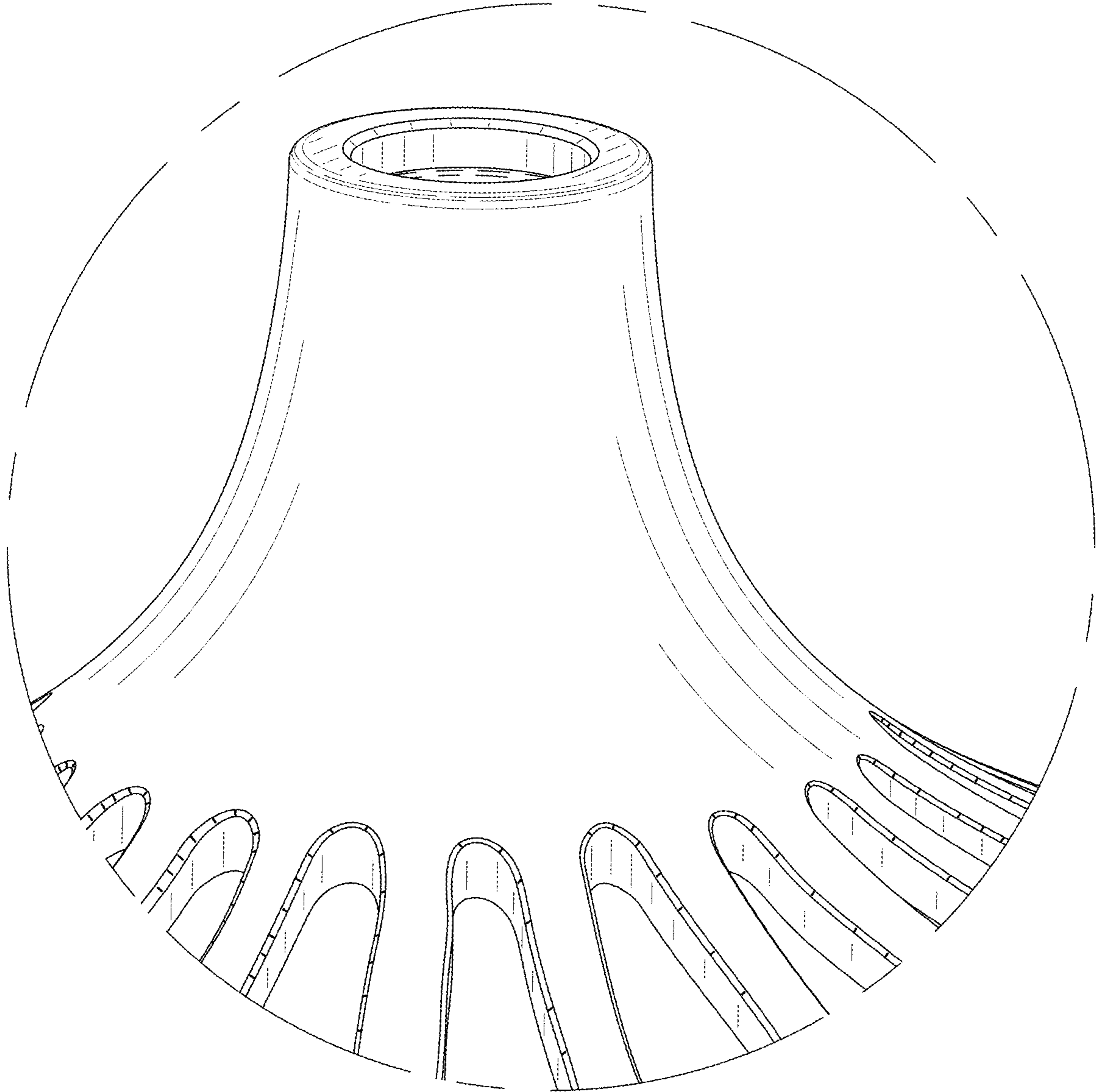

FIG. 8