



US00D958875S

(12) **United States Design Patent** (10) **Patent No.:** **US D958,875 S**  
**Aida** (45) **Date of Patent:** **\*\* Jul. 26, 2022**

- (54) **PRINTER**
- (71) Applicant: **FUJIFILM Corporation**, Tokyo (JP)
- (72) Inventor: **Yukari Aida**, Tokyo (JP)
- (73) Assignee: **FUJIFILM Corporation**, Tokyo (JP)
- (\*\*) Term: **15 Years**
- (21) Appl. No.: **29/754,333**
- (22) Filed: **Oct. 9, 2020**
- (30) **Foreign Application Priority Data**

Apr. 10, 2020 (JP) ..... 2020-007618 D

- (51) **LOC (13) Cl.** ..... **19-02**
- (52) **U.S. Cl.**  
USPC ..... **D18/14**
- (58) **Field of Classification Search**  
USPC ..... D18/12, 14-19, 36-41, 50, 45, 54, 55,  
D18/53, 56; D19/65, 66, 67, 68, 69, 70,  
D19/71; D14/301, 307, 121  
CPC ..... H04N 1/00204; H04N 1/00249; H04N  
1/00278; G06K 15/12; G06K 15/14; B41J  
3/00; B41J 3/46; B41J 2/3358; B41J  
3/382; B41J 3/445; B41J 3/28; B41J  
11/0045; B41J 3/36

See application file for complete search history.

(56) **References Cited**

**U.S. PATENT DOCUMENTS**

- D307,157 S \* 4/1990 Sakaguchi ..... D18/54
- D322,982 S \* 1/1992 Tashiro ..... D18/54
- D358,138 S \* 5/1995 Koyanagi ..... D14/368
- D541,332 S \* 4/2007 Tsuchiya ..... D18/50
- D545,355 S \* 6/2007 Katayama ..... D18/50
- 7,690,785 B2 \* 4/2010 Silverbrook ..... B41J 3/445  
347/108
- D732,108 S \* 6/2015 Ryu ..... D18/14
- D740,358 S \* 10/2015 Kang ..... D18/14

(Continued)

**FOREIGN PATENT DOCUMENTS**

- CN 111791602 A \* 10/2020
- CN 111845115 A \* 10/2020
- CN 111845116 A \* 10/2020
- CN 112519422 A \* 3/2021 ..... B41J 2/01

- CN 112571982 A \* 3/2021
- CN 307054473 \* 1/2022
- JP 1681235 S 3/2021
- JP D1681235 \* 3/2022

**OTHER PUBLICATIONS**

Amazon. Link: [https://www.amazon.com/Fujifilm-Smartphone-Stickers-All-Purpose-Microfiber/dp/B09P4875H6/ref=sr\\_1\\_1?crid=CE5HR8CJM32&keywords=B09P484S7X&qid=1648132942&s=electronics&sprefix=b09p484s7x%2Celectronics%2C52&sr=1-1&th=1](https://www.amazon.com/Fujifilm-Smartphone-Stickers-All-Purpose-Microfiber/dp/B09P4875H6/ref=sr_1_1?crid=CE5HR8CJM32&keywords=B09P484S7X&qid=1648132942&s=electronics&sprefix=b09p484s7x%2Celectronics%2C52&sr=1-1&th=1). Dec. 24, 2021. Fujifilm Instax Wide Link Smartphone Printer. (Year: 2021).\*

(Continued)

*Primary Examiner* — Lauren D McVey

(74) *Attorney, Agent, or Firm* — Studebaker & Brackett PC

(57) **CLAIM**

The ornamental design for a printer, as shown and described.

**DESCRIPTION**

FIG. 1 is a top, front, and right side perspective view of a first embodiment of printer, showing the new design;  
 FIG. 2 is a front view thereof;  
 FIG. 3 is a rear view thereof;  
 FIG. 4 is a right side view thereof;  
 FIG. 5 is a left side view thereof;  
 FIG. 6 is a top view thereof;  
 FIG. 7 is a bottom view thereof;  
 FIG. 8 is a top, front, and right side perspective view of a second embodiment of printer, showing the new design;  
 FIG. 9 is a front view thereof;  
 FIG. 10 is a rear view thereof;  
 FIG. 11 is a right side view thereof;  
 FIG. 12 is a left side view thereof;  
 FIG. 13 is a top view thereof; and,  
 FIG. 14 is a bottom view thereof.

**1 Claim, 14 Drawing Sheets**

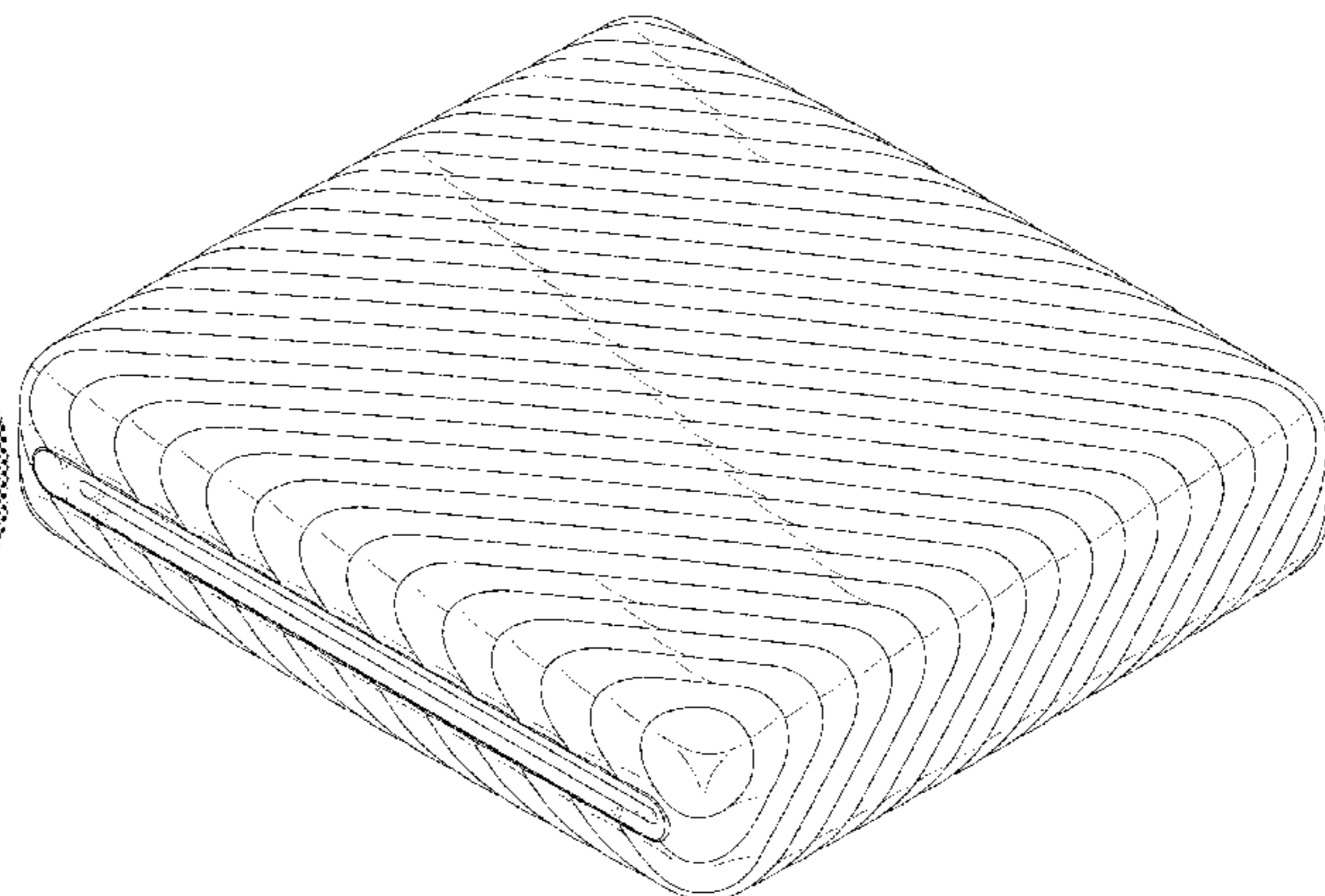
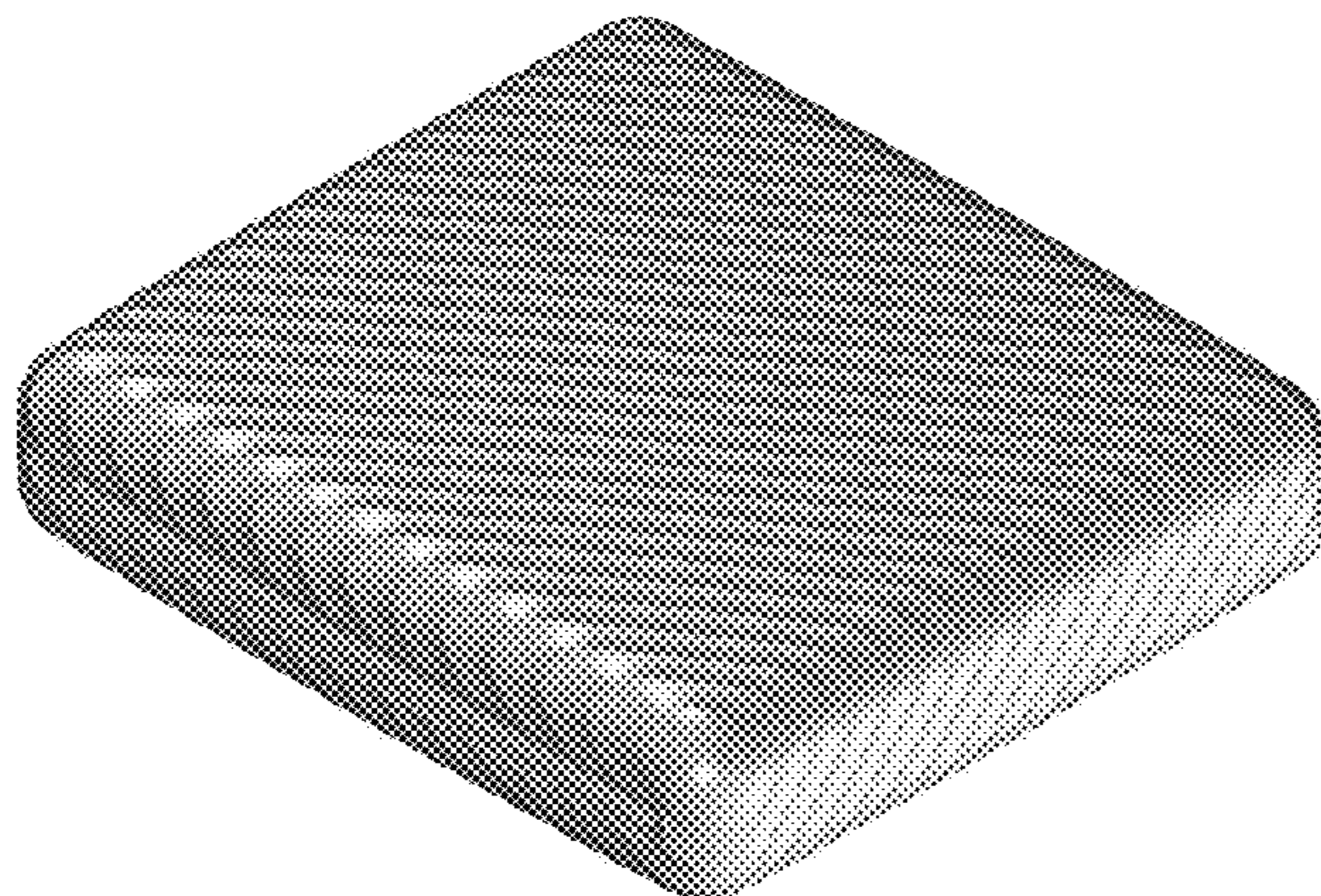

(56)

**References Cited**

U.S. PATENT DOCUMENTS

D799,590 S \* 10/2017 Dwyer ..... D18/50  
D876,536 S \* 2/2020 Shirley ..... D18/50  
2005/0237556 A1 \* 10/2005 Watkins ..... B41J 3/46  
710/72  
2020/0164654 A1 \* 5/2020 Xing ..... B41J 29/38  
2020/0290368 A1 \* 9/2020 Usuki ..... H04N 1/50

OTHER PUBLICATIONS

Walmart. Link: <https://www.walmart.com/ip/GOOJPRT-P6-Pocket-Mini-Printer-Portable-BT-Wireless-Thermal-Receipt-Label-Sticker-Memo-AR-Photo-Picture-Instant-Mobile-203DPI-Resolution-Compatible-A/418162801?athbdg=L1700>. Visited Jan. 27, 2022. GOOJPRT P6 Pocket Mini Printer. (Year: 2022).\*

Walmart. Link: <https://www.walmart.com/ip/Canon-QX10PINK-SELPHY-Square-QX10-Compact-Photo-Printer-Pink/390816886>. Visited Jan. 26, 2022. Canon QX10PINK SELPHY Square QX10 Compact Photo Printer (Pink). (Year: 2022).\*

Amazon. Link: [https://www.amazon.com/BENTSAI-Handheld-Printer-Printing-Production/dp/B09FL1CK81/ref=sr\\_1\\_19?crid=1B0DO6SB6JUZF&keywords=handheld+printer&qid=1643285212&srefix=handheld+printers%2Caps%2C80&sr=8-19](https://www.amazon.com/BENTSAI-Handheld-Printer-Printing-Production/dp/B09FL1CK81/ref=sr_1_19?crid=1B0DO6SB6JUZF&keywords=handheld+printer&qid=1643285212&srefix=handheld+printers%2Caps%2C80&sr=8-19). Sep. 7, 2021. BENTSAI B10 Mini Handheld Printer. (Year: 2021).\*

An Office Action mailed by the Japanese Patent Office dated Jul. 6, 2021, which corresponds to Japanese Design Application No. 2020-019382 and is related to Design U.S. Appl. No. 29/754,333 with partial English language translation.

\* cited by examiner

FIG.1

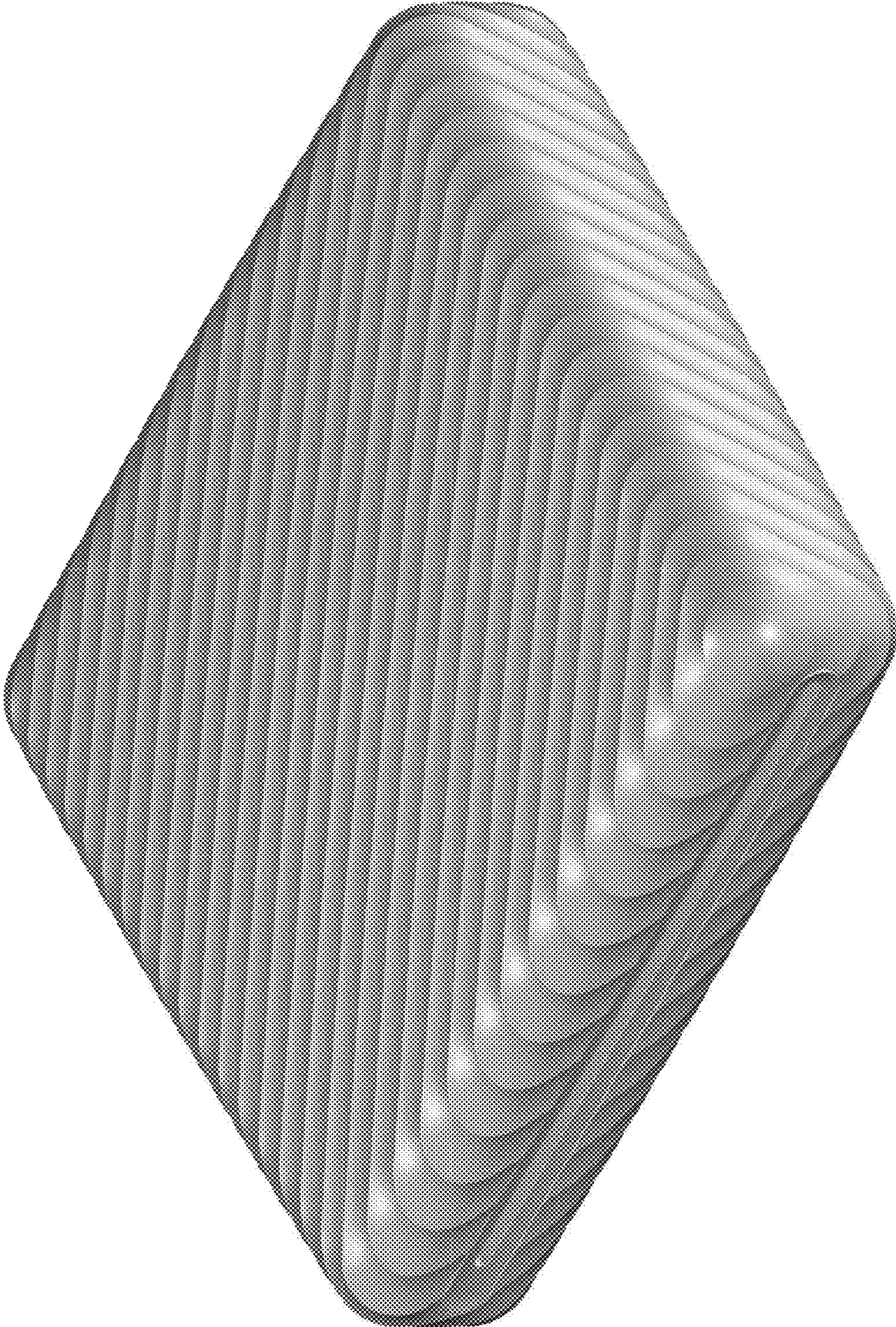

FIG.2

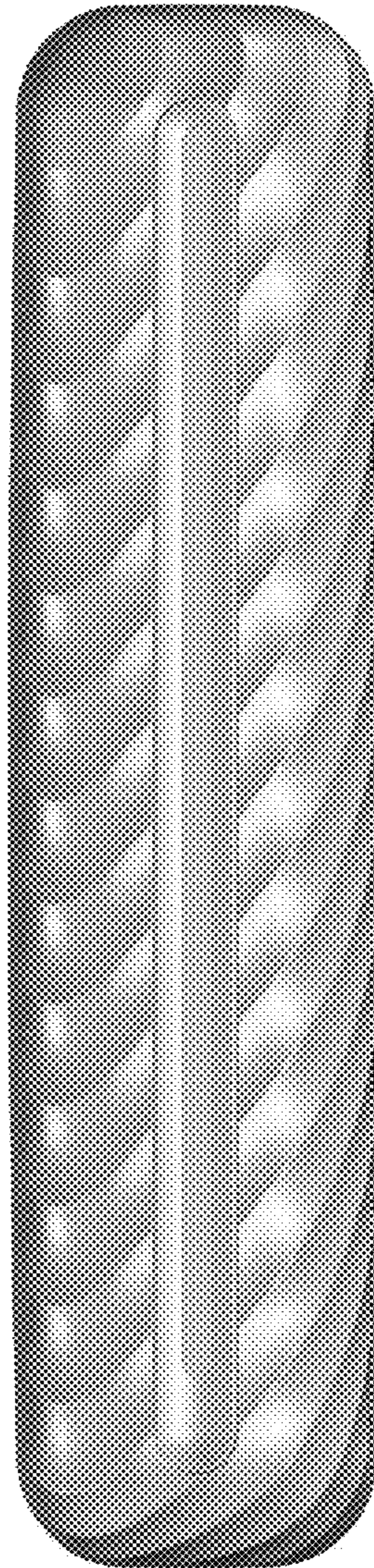

FIG.3

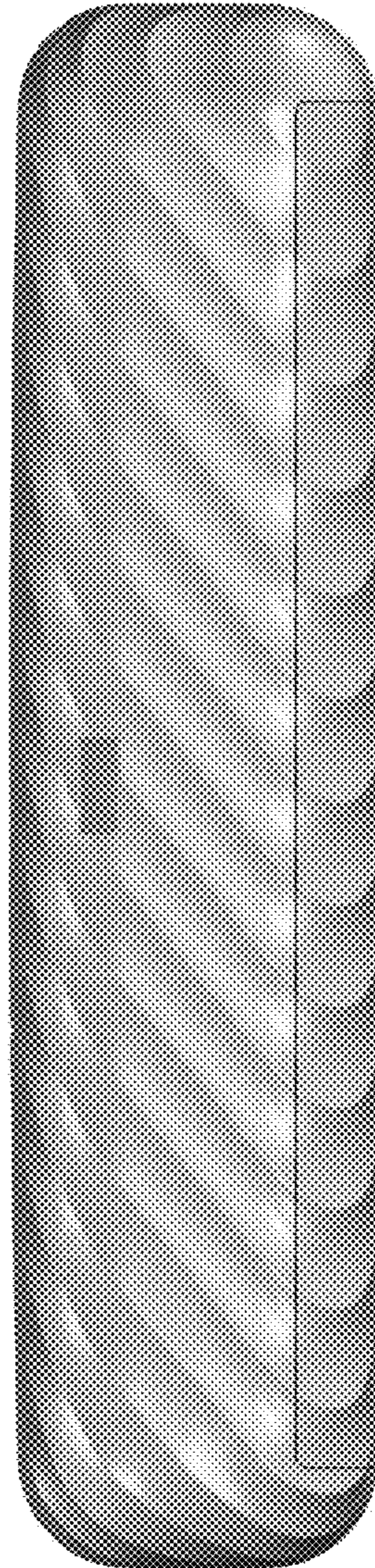

FIG.4

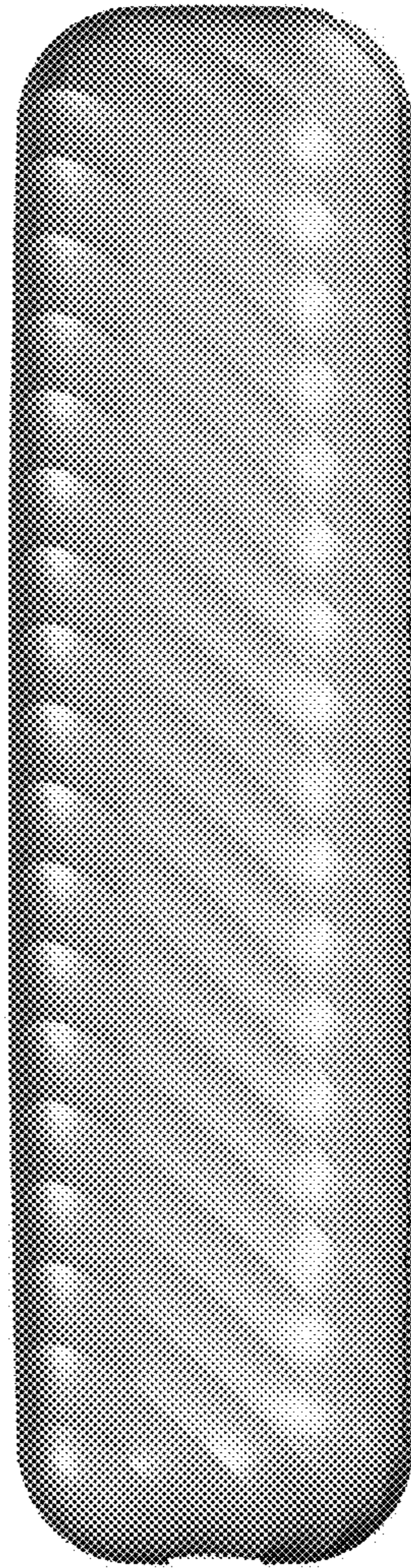

FIG. 5

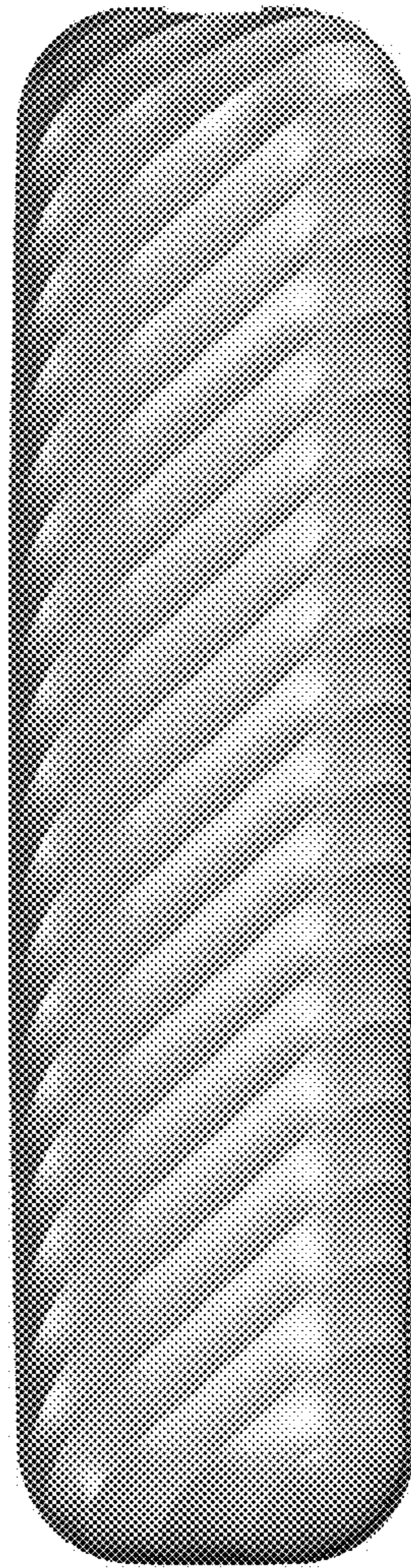

FIG.6

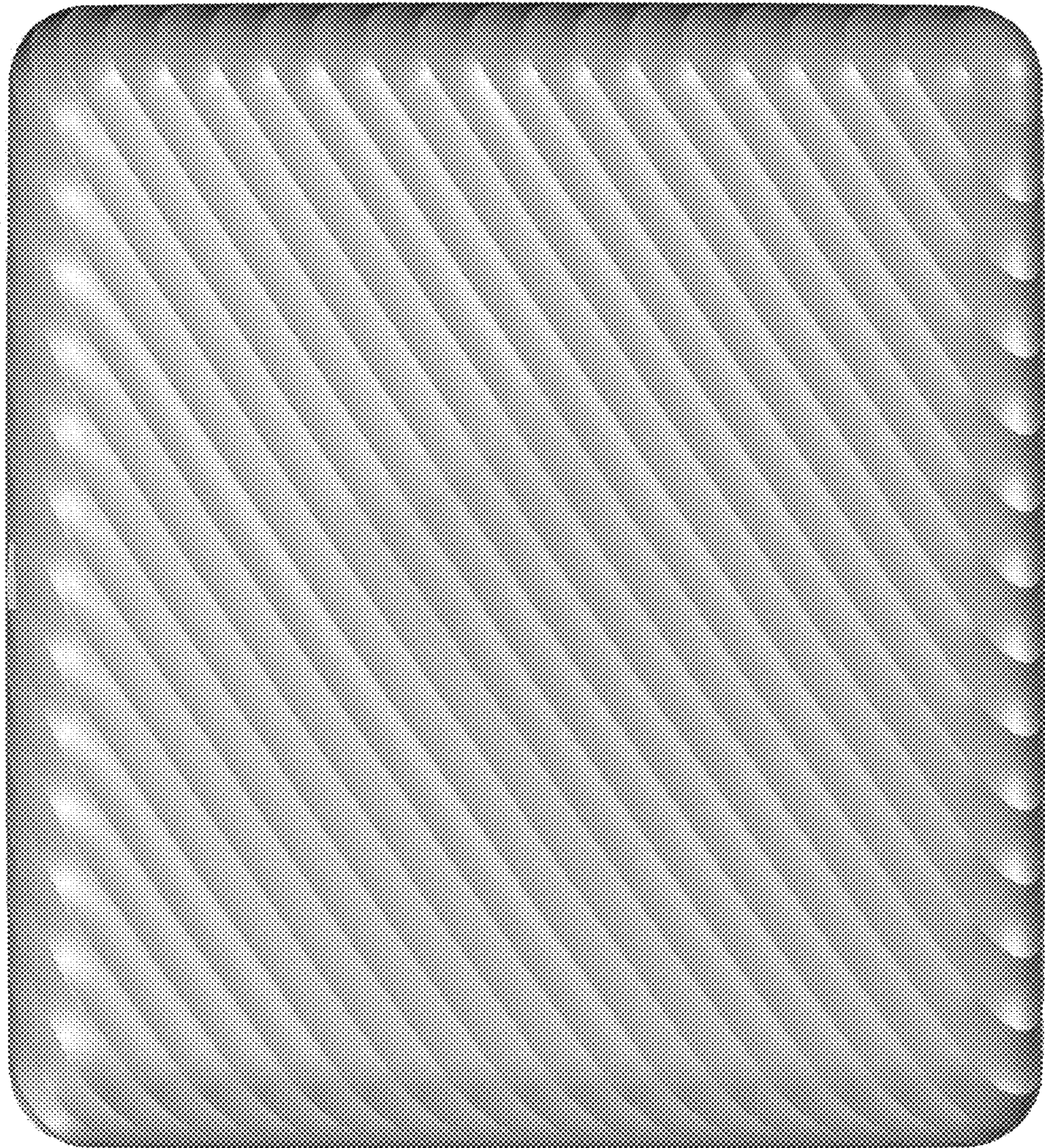



FIG.7

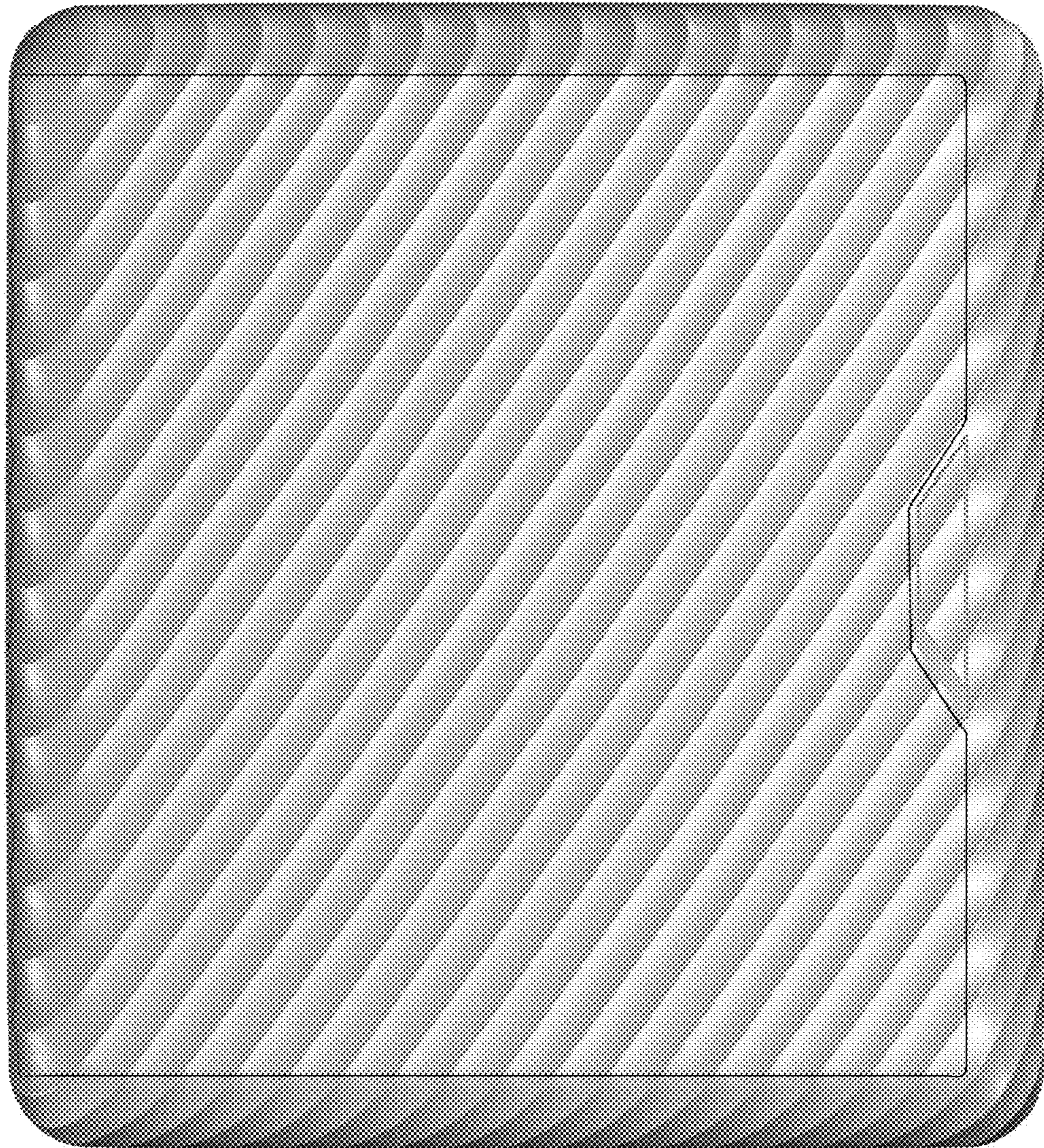

FIG. 8

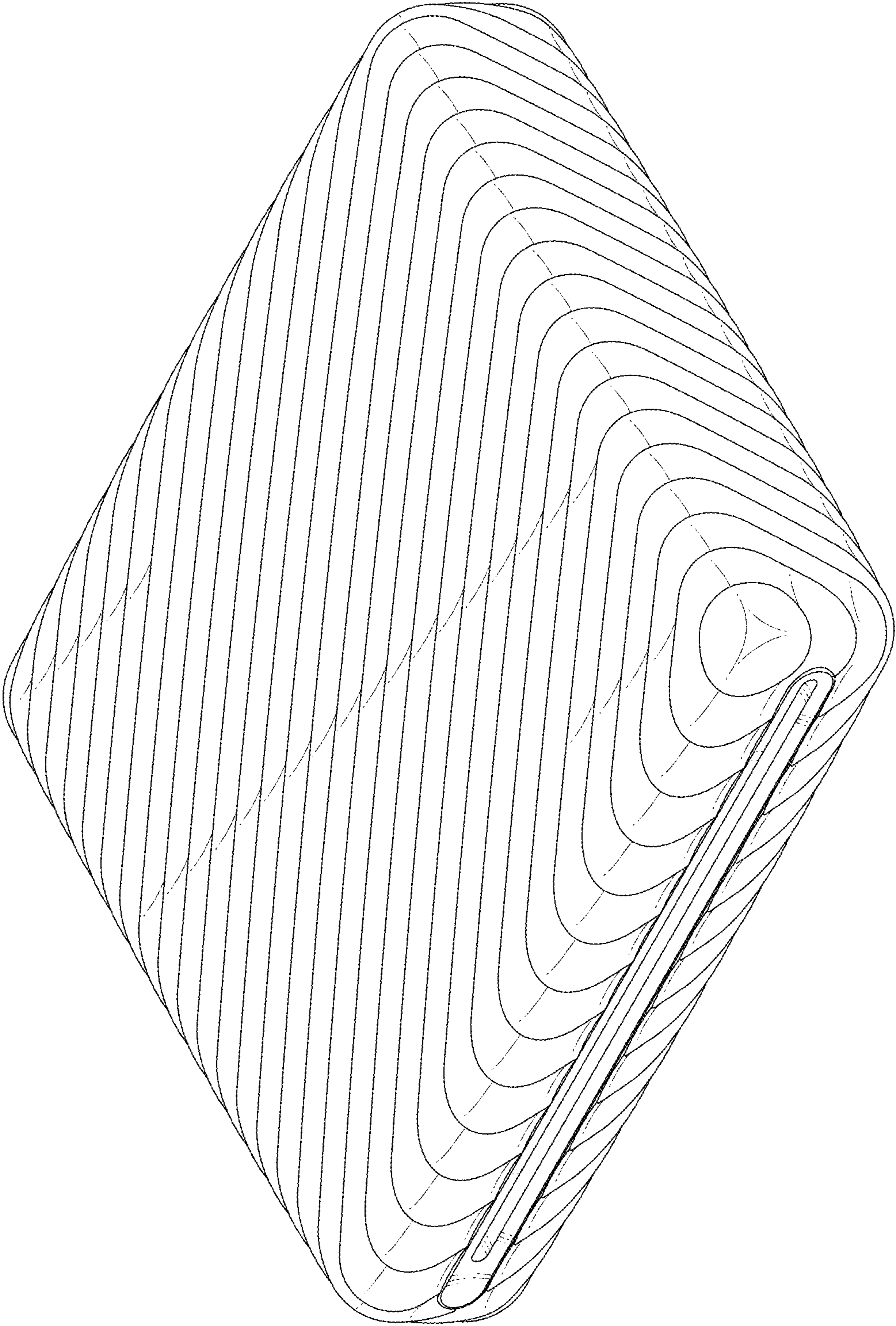

FIG.9

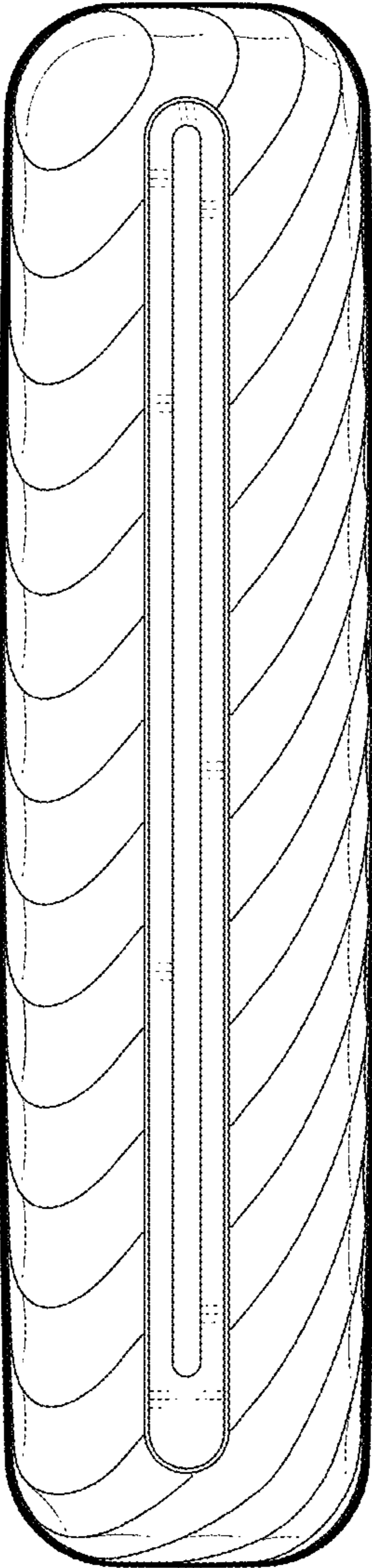

FIG.10

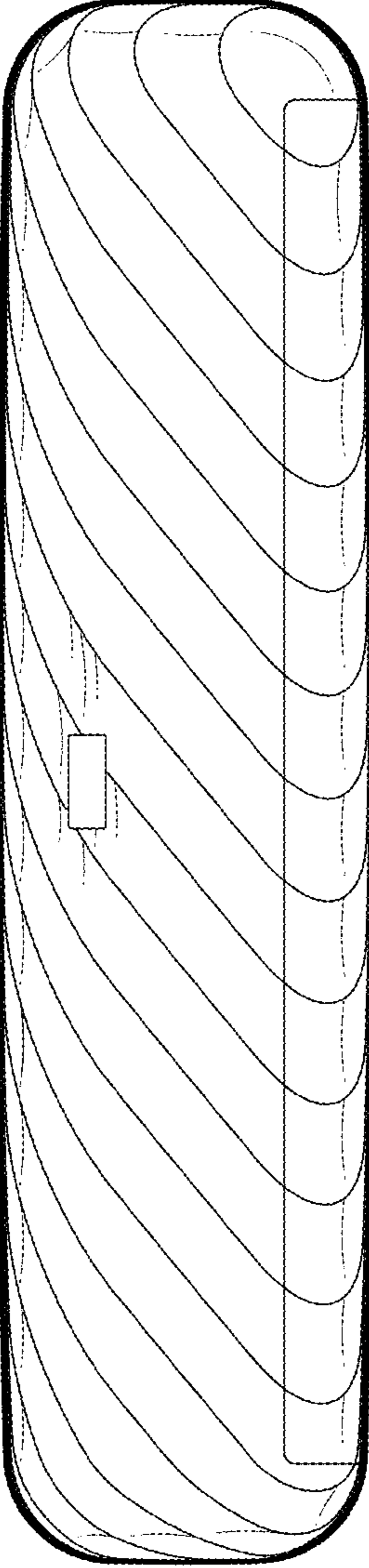

FIG.11

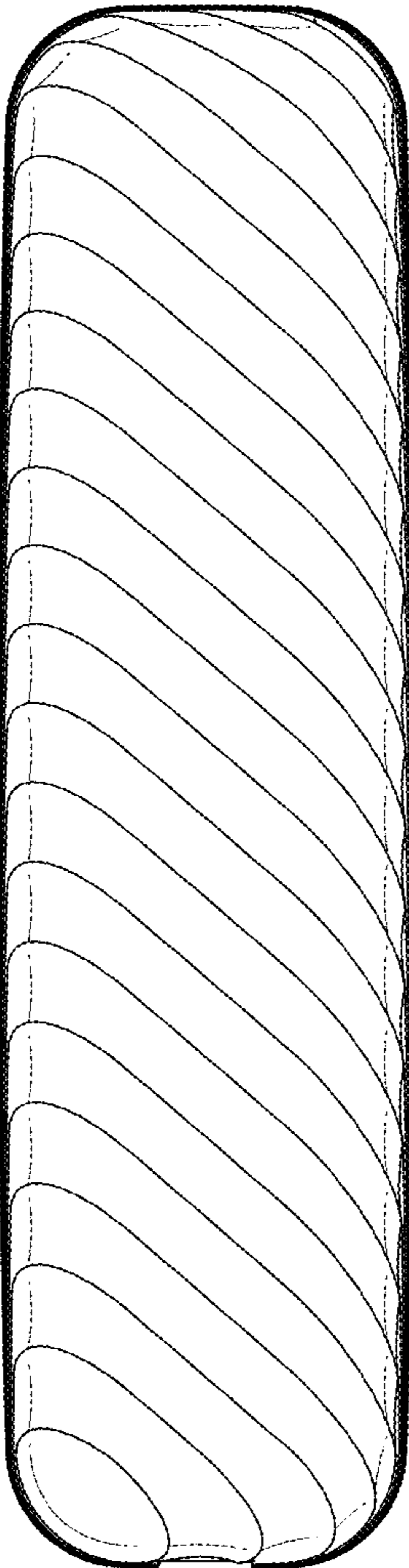

FIG.12

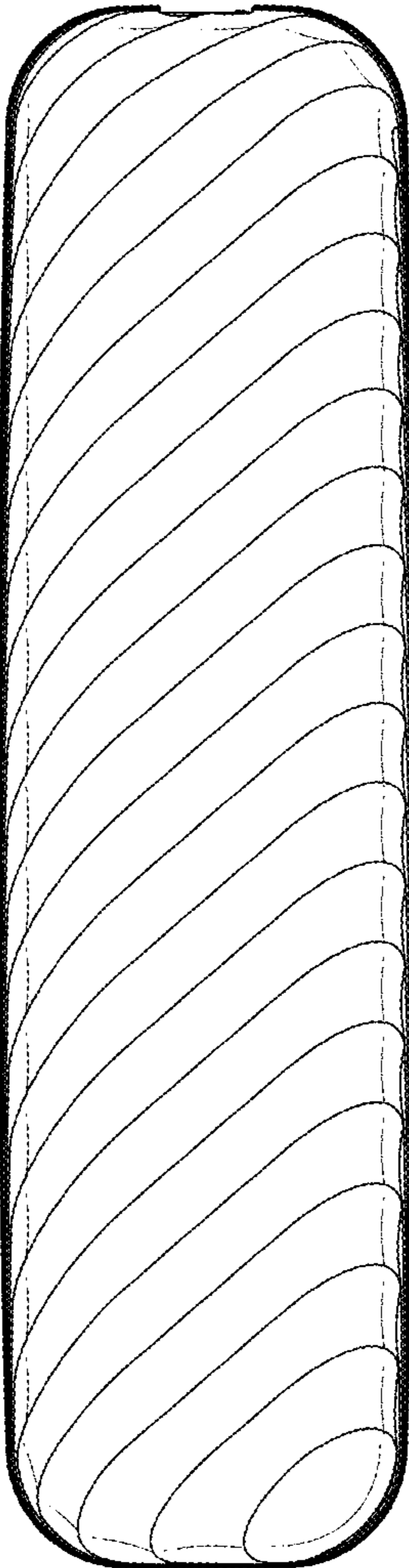

FIG.13

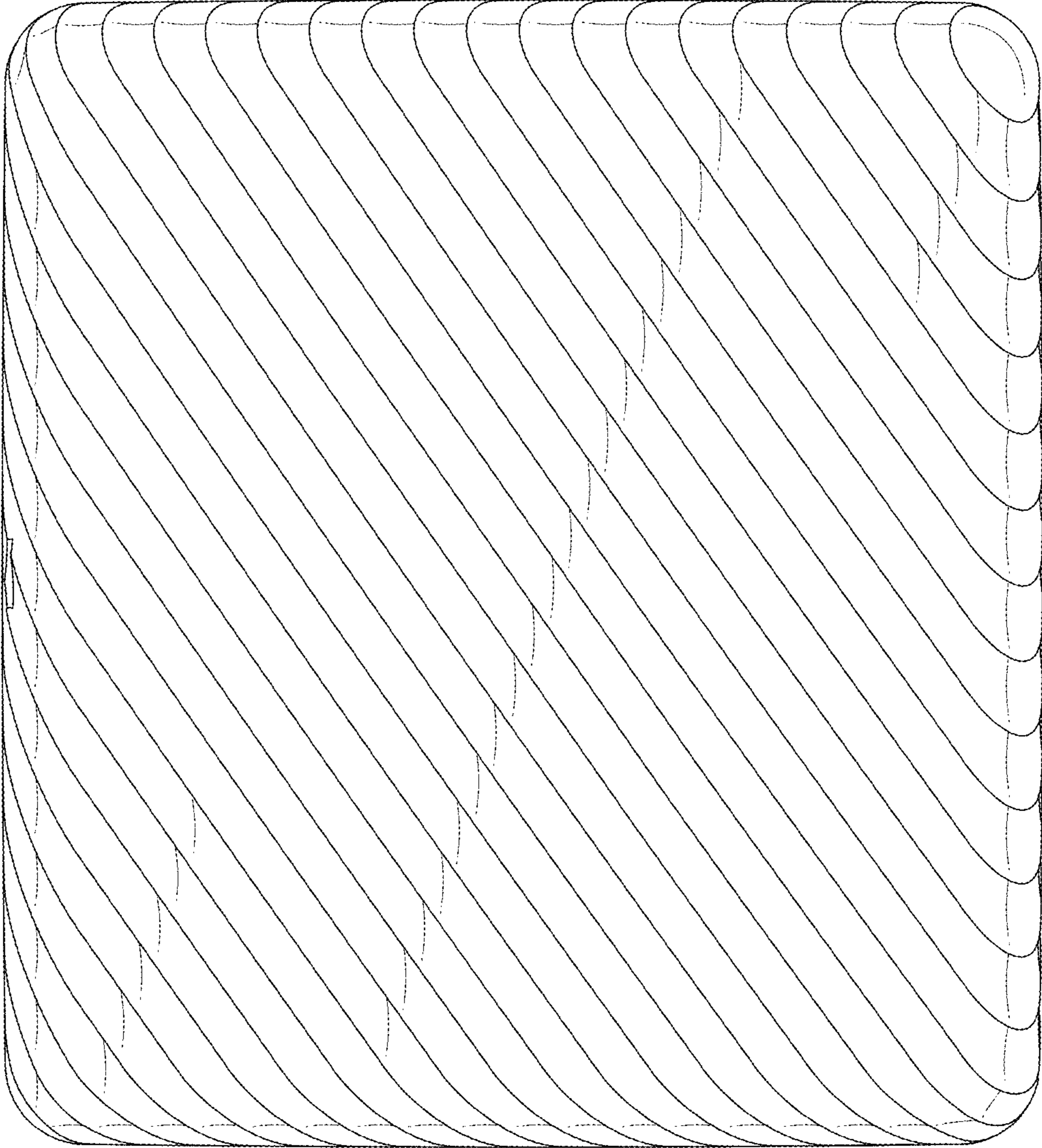

FIG.14

