



US00D958863S

(12) **United States Design Patent**
Miyake et al.

(10) **Patent No.:** **US D958,863 S**

(45) **Date of Patent:** **** Jul. 26, 2022**

(54) **CAMERA WITH A WINDJAMMER**

(71) Applicant: **SONY CORPORATION**, Tokyo (JP)

(72) Inventors: **Ryo Miyake**, Kanagawa (JP); **Satoru Yoshioka**, Chiba (JP)

(73) Assignee: **SONY CORPORATION**, Tokyo (JP)

(**) Term: **15 Years**

(21) Appl. No.: **29/758,987**

(22) Filed: **Nov. 19, 2020**

(30) **Foreign Application Priority Data**

May 19, 2020	(JP)	2020-009828	D
May 19, 2020	(JP)	2020-009829	D
May 19, 2020	(JP)	2020-009830	D
May 21, 2020	(JP)	2020-009992	D
May 21, 2020	(JP)	2020-009993	D

(51) **LOC (13) Cl.** **16-01**

(52) **U.S. Cl.**
USPC **D16/200**

(58) **Field of Classification Search**
USPC D16/200, 202, 206, 208, 217, 218, 219,
D16/250; D14/225, 226, 227, 228;
D21/513, 514, 517; D2/895
CPC G03B 15/03; G03B 15/05; G03B 17/02;
G03B 2219/02; G03B 19/18; H04N
5/2251; H04N 5/2252; H04N 5/2253;
H04N 5/2254; H04N 5/22525; H04N
5/23216; H04N 5/232939; H04N
2101/00; H04N 7/142

See application file for complete search history.

(56) **References Cited**

U.S. PATENT DOCUMENTS

D669,930 S * 10/2012 Koyama D16/219
D671,976 S * 12/2012 Akita D16/219

(Continued)

OTHER PUBLICATIONS

“Sony ZV-1 Digital Camera for Content Creators, Vlogging and YouTube with Flip Screen, Built-in Microphone, 4K HDR Video, Touchscreen Display, Live Video Streaming, Webcam” from Amazon.com, first available May 26, 2020 from the internet <https://www.amazon.com/gp/product/B08965JV8D/ref=ox_sc_act_title_2?smid=ATVPDKIKX0DER&th=1>(Year: 2020).*

(Continued)

Primary Examiner — Rosemary K Tarcza

Assistant Examiner — Lacey Chey Bowman

(74) *Attorney, Agent, or Firm* — Michael Best and Friedrich LLP

(57) **CLAIM**

The ornamental design for a camera with a windjammer, as shown and described.

DESCRIPTION

FIG. 1 is a perspective view of a first embodiment of a camera with a windjammer showing our new design; FIG. 2 is a front elevational view thereof; FIG. 3 is a rear elevational view thereof; FIG. 4 is a right side elevational view thereof; FIG. 5 is a left side elevational view thereof; FIG. 6 is a top plan view thereof; and FIG. 7 is a bottom plan view thereof. FIG. 8 is a perspective view of a second embodiment of a camera with a windjammer showing our new design; FIG. 9 is a front elevational view thereof; FIG. 10 is a rear elevational view thereof; FIG. 11 is a right side elevational view thereof; FIG. 12 is a left side elevational view thereof; FIG. 13 is a top plan view thereof; and, FIG. 14 is a bottom plan view thereof.

The broken lines showing the camera portions or the windjammer attaching member portions form no part of the claimed design.

1 Claim, 14 Drawing Sheets

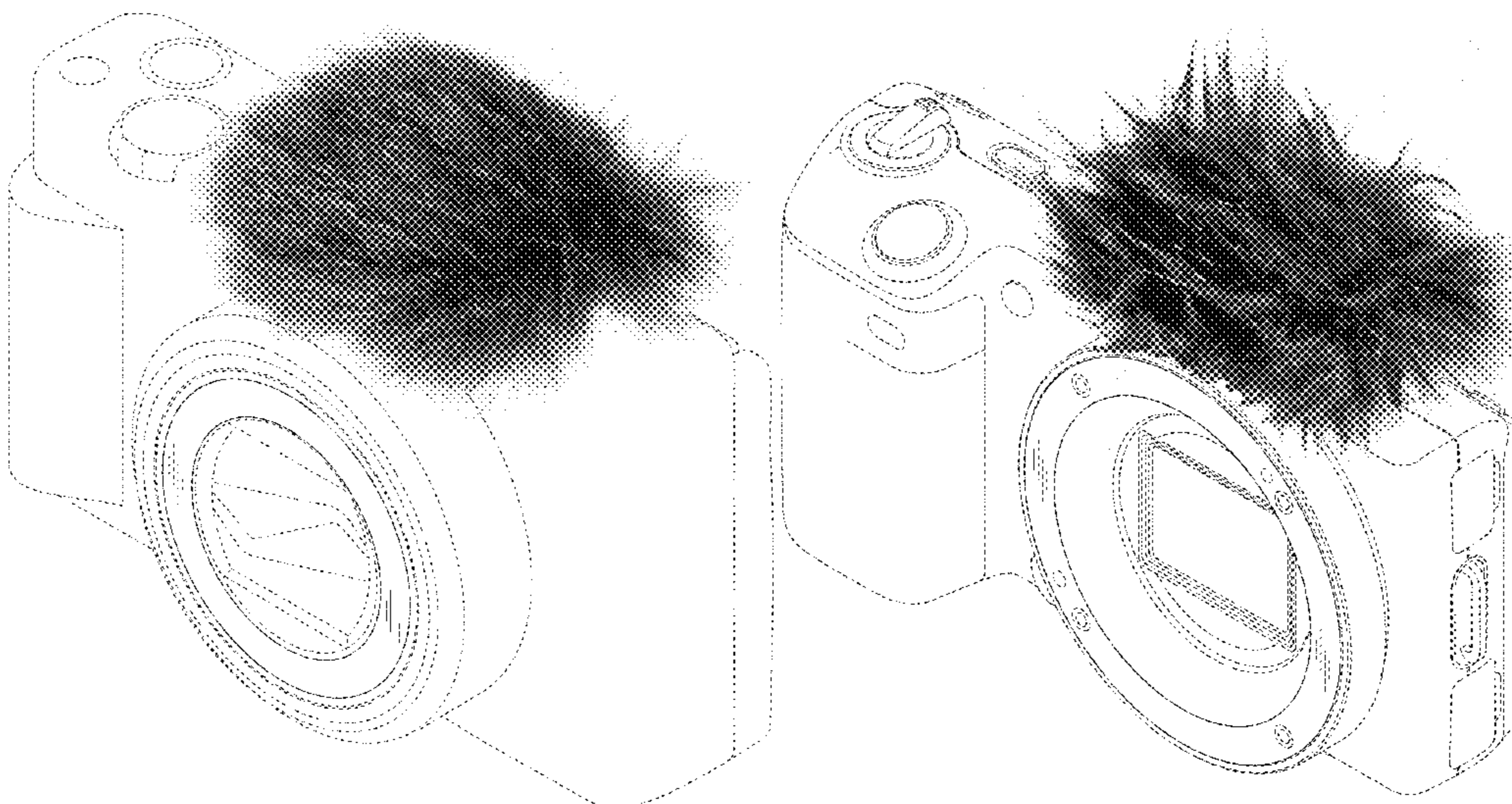

(56)

References Cited

U.S. PATENT DOCUMENTS

D688,722 S	*	8/2013	Akita	D16/219
D728,653 S	*	5/2015	Kim	D16/202
D764,560 S	*	8/2016	Jang	D16/202
D852,254 S	*	6/2019	Saito	D16/202
D870,185 S	*	12/2019	Nagaoka	D16/219

OTHER PUBLICATIONS

“Camera Mic Windscreen, Wind Muff Compatible for Camera DSLR, G7X2 Built-in Microphone, with 16 Stickies and 8 Fur Covers by YOUSHARES(White)” from Amazon.com, first available Aug. 17, 2021 from the internet <[https://www.amazon.com/dp/B09CSJX22Y/ref=sspa_dk_detail_2?psc=1p13NParams&spLa=](https://www.amazon.com/dp/B09CSJX22Y/ref=sspa_dk_detail_2?psc=1p13NParams&spLa=ZW5jcnlwdGVkUXVhbGlmaWVyPUFQTEMxMEJYMIM4ODcm)

ZW5jcnlwdGVkSWQ9QTA3MDc3OThBOEw3UkVRVjFHN1omZW5jcnlwdGVkQWRJZD1BMDczMjk5N0RFSIZQME1EVU83MCZ3aWRnZXROYW1IPXNwX2RldGFpbDlmYWN0aW9uPWNs aWNRUmVkaXJlY3QmZG9Ob3RMb2dDbGljaz10cnVI>. (Year: 2021).*

“Wind Muff Windscreen Compatible with Zoom H1,Mic Windscreen Wind Cover Compatible with Zoom H1 H1n Recorder Mic and More,ChromLives Furry Microphone Windscreen 2.5"X 40mm (LxD) for Outdoor/Indoor Use” from Amazon.com, first available Sep. 8, 2018 from the internet <https://www.amazon.com/dp/B07H6HFPKS/ref=emc_b_5_i?th=1>(Year: 2018).*

“Andoer Furry Outdoor Microphone Windscreen Muff Mini Lavalier Microphone Windshield” from Walmart.com, first retrieved on Dec. 3, 2021 from the internet <<https://www.walmart.com/ip/Andoer-Furry-Outdoor-Microphone-Windscreen-Muff-Mini-Lavalier-Microphone-Windshield/325473632>> (Year: 2021).*

* cited by examiner

FIG.1

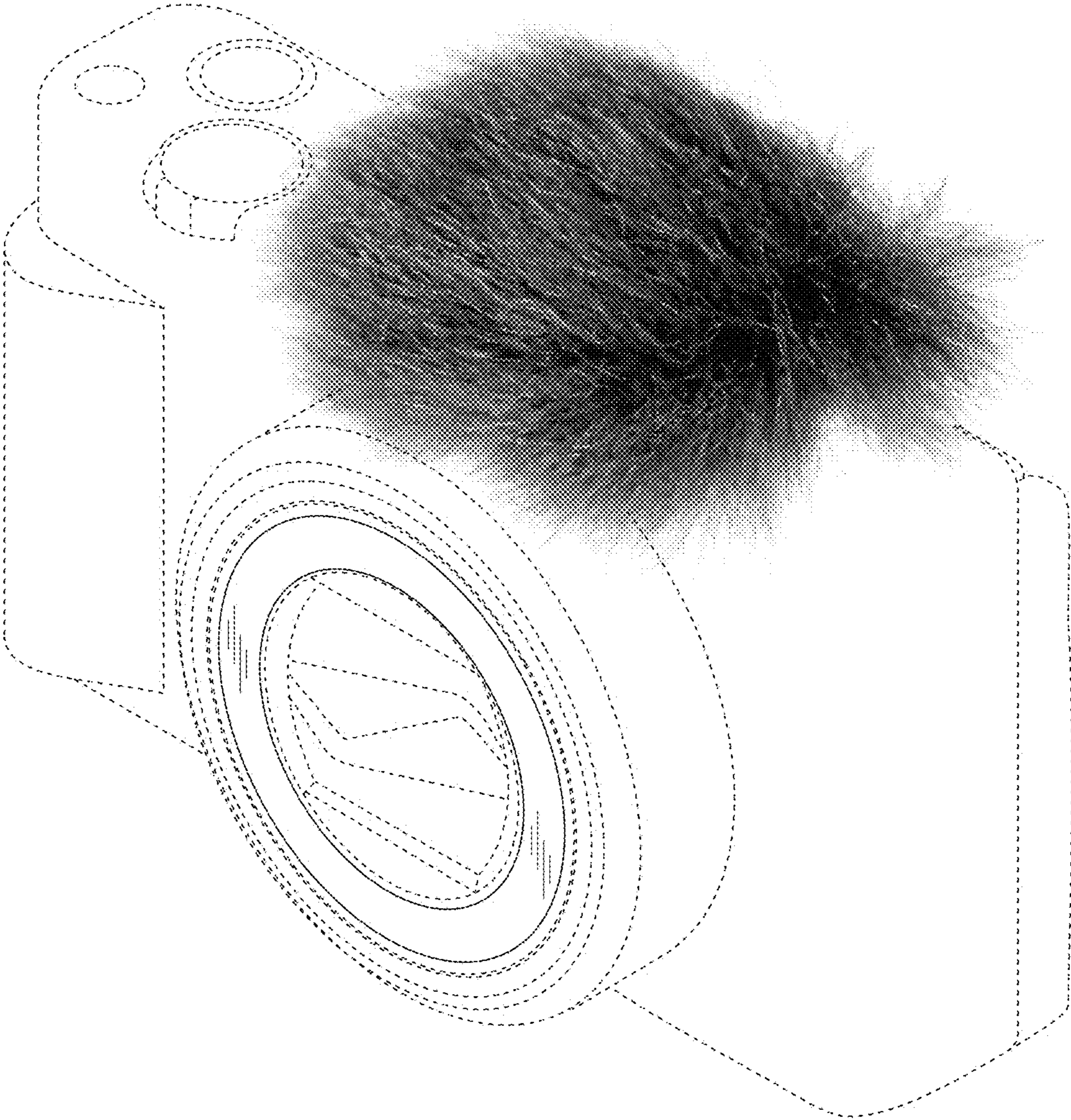

FIG.2

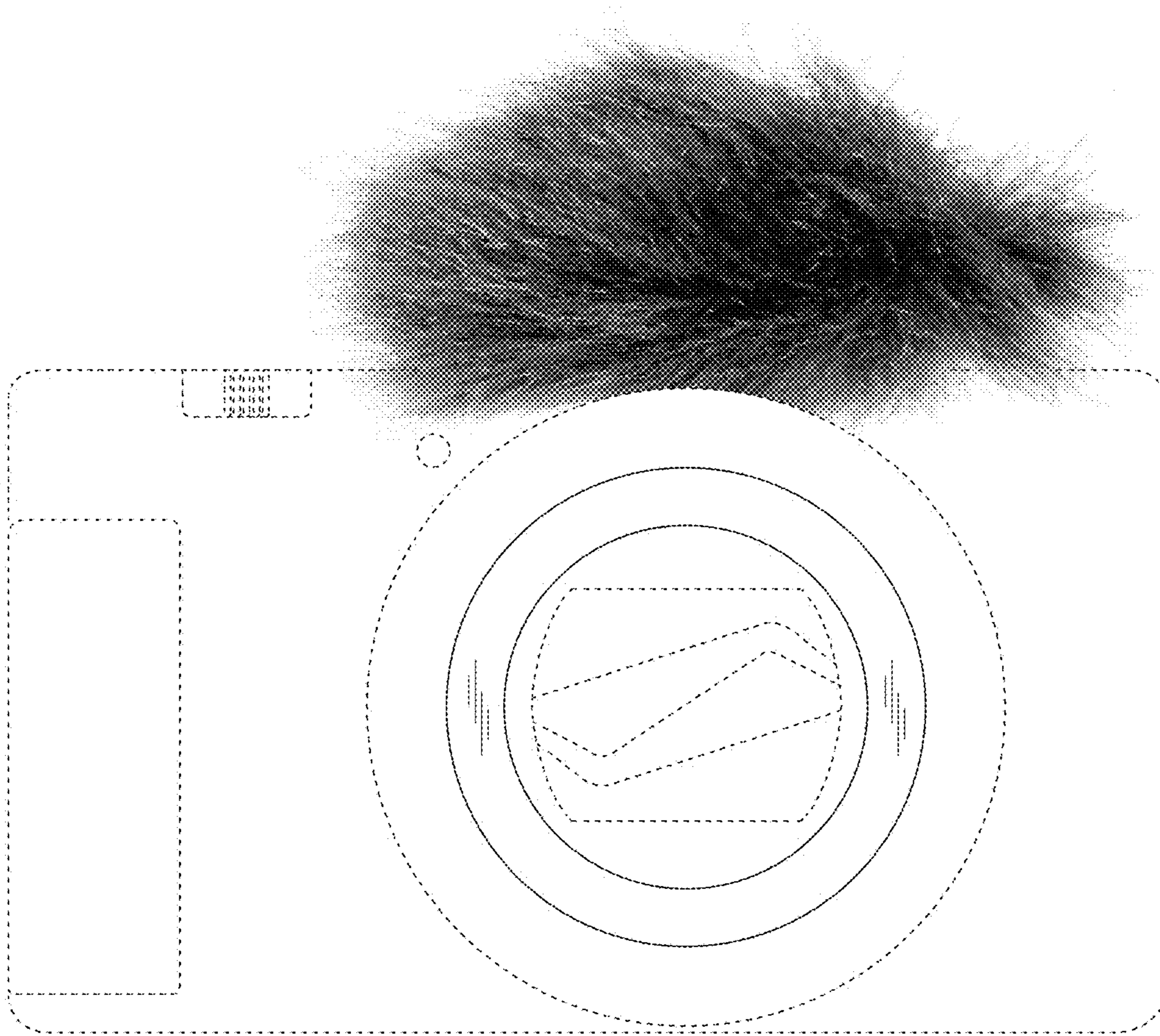

FIG.3

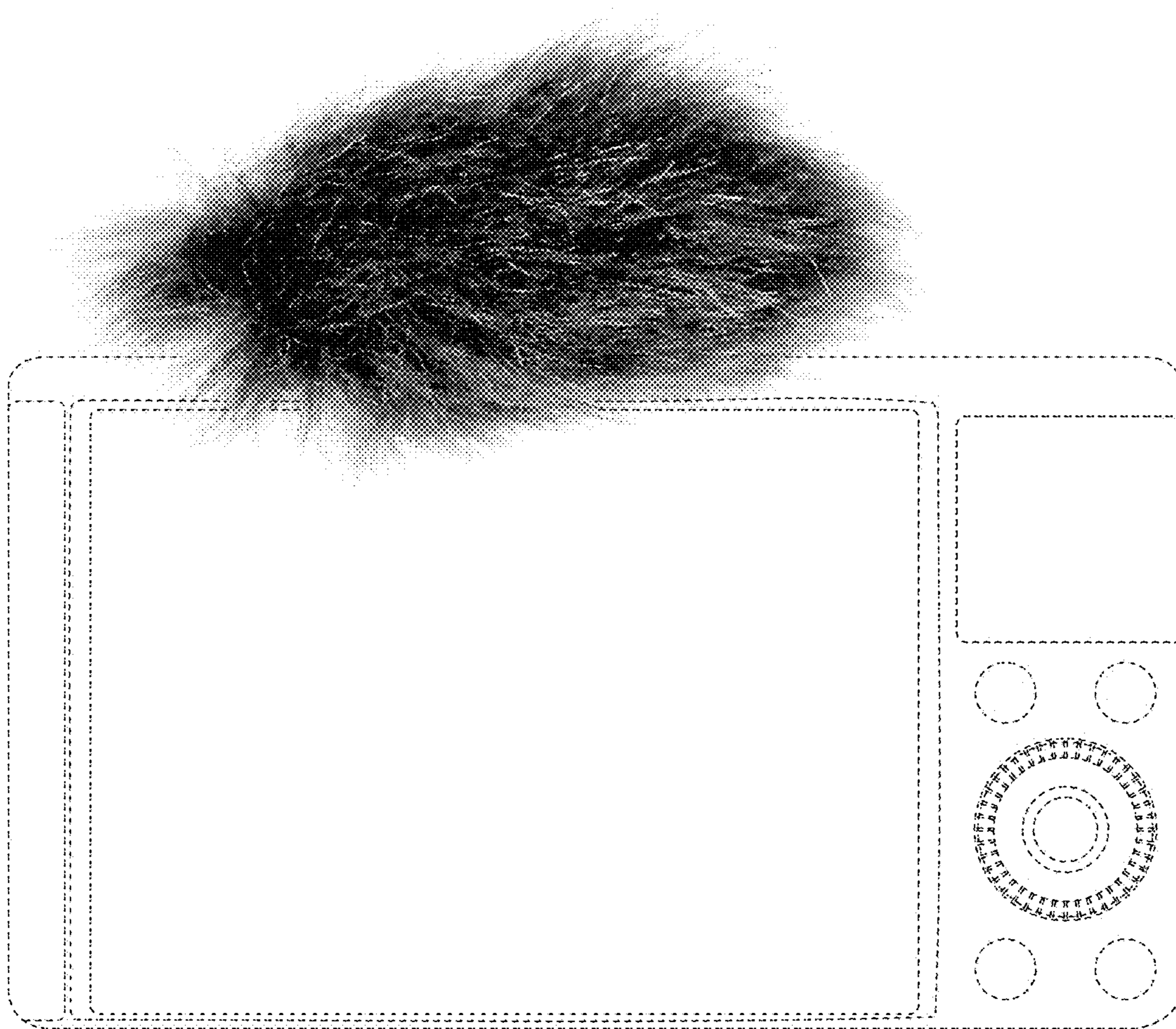

FIG.4

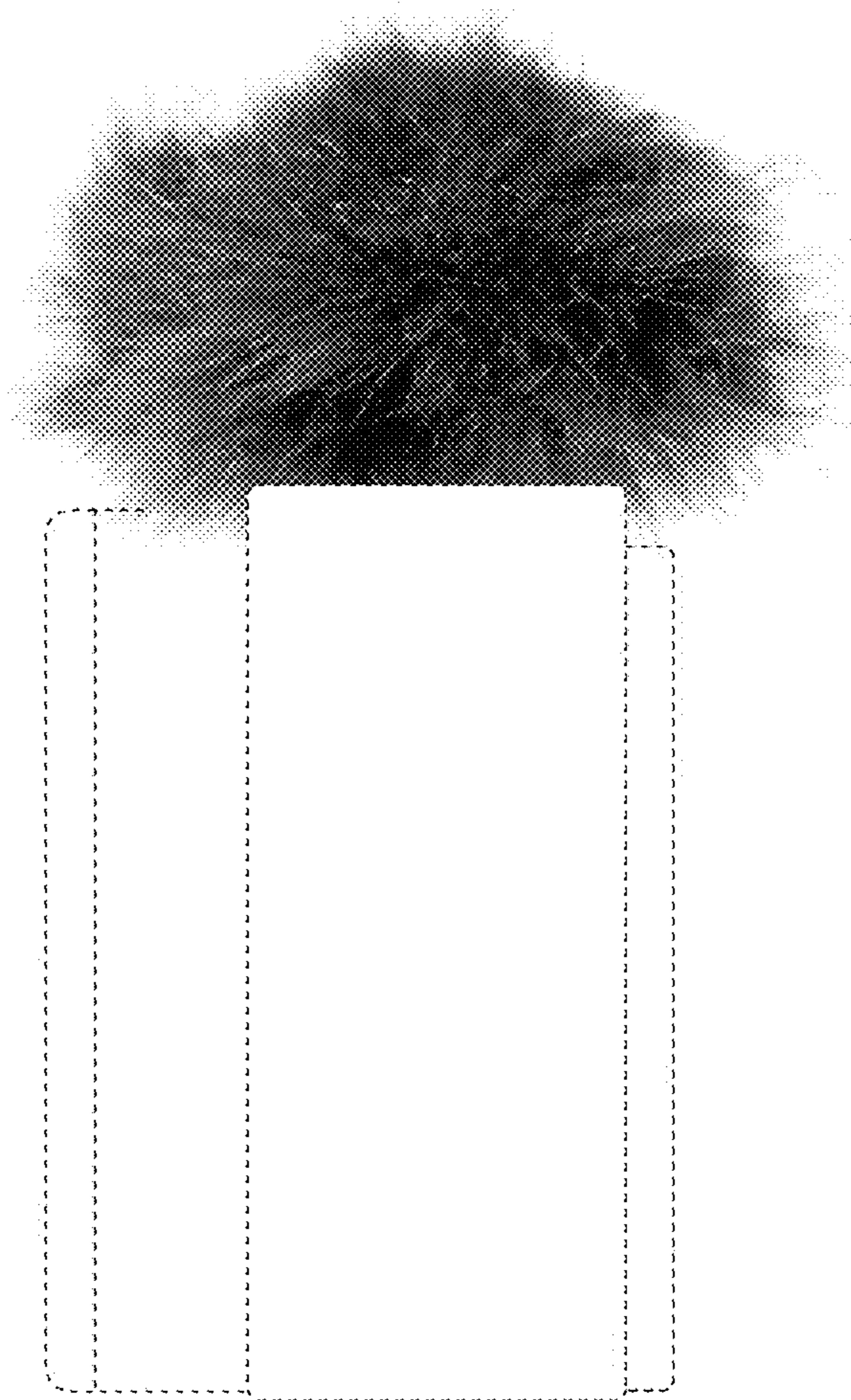

FIG.5

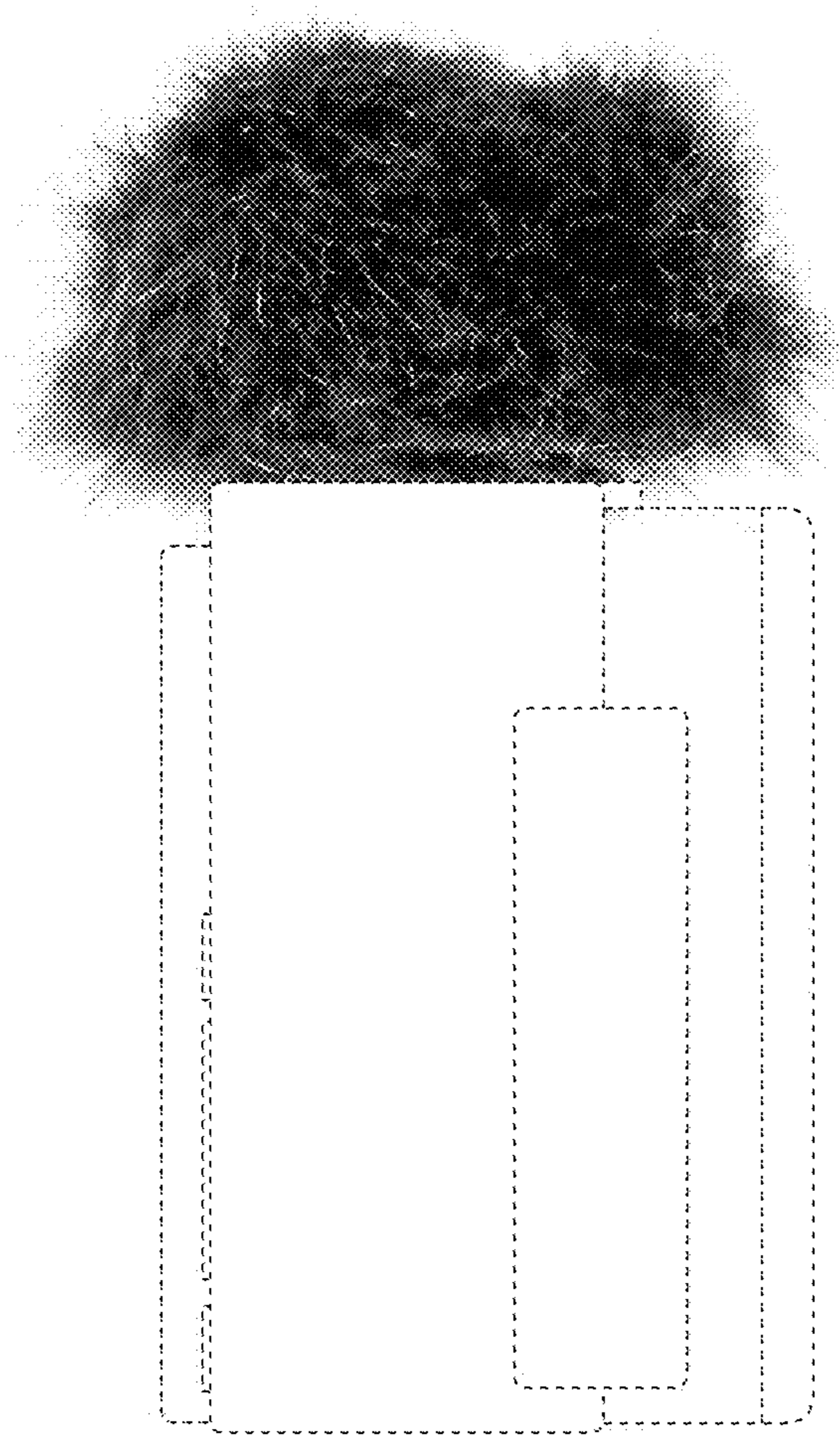

FIG.6

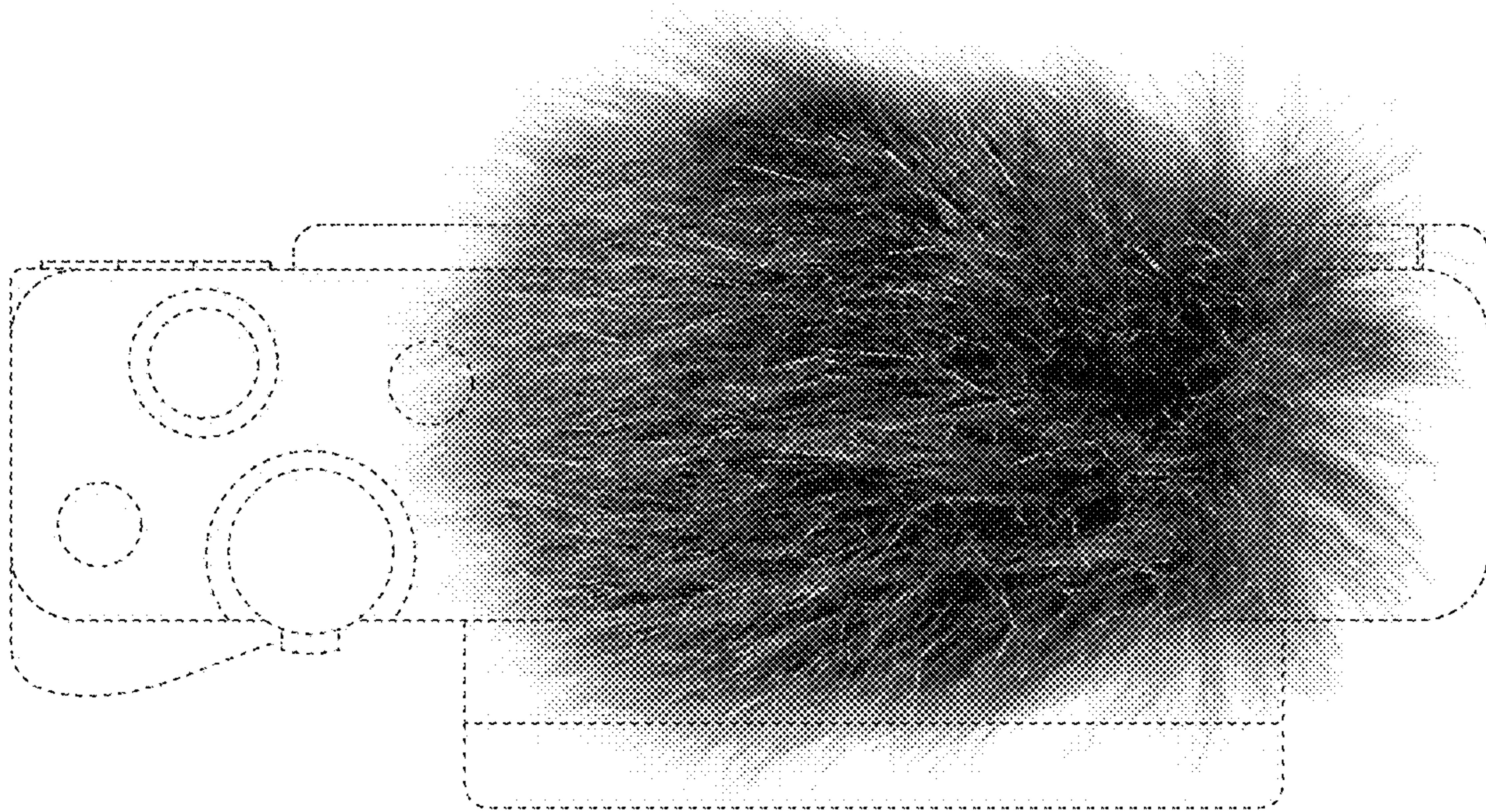

FIG.7

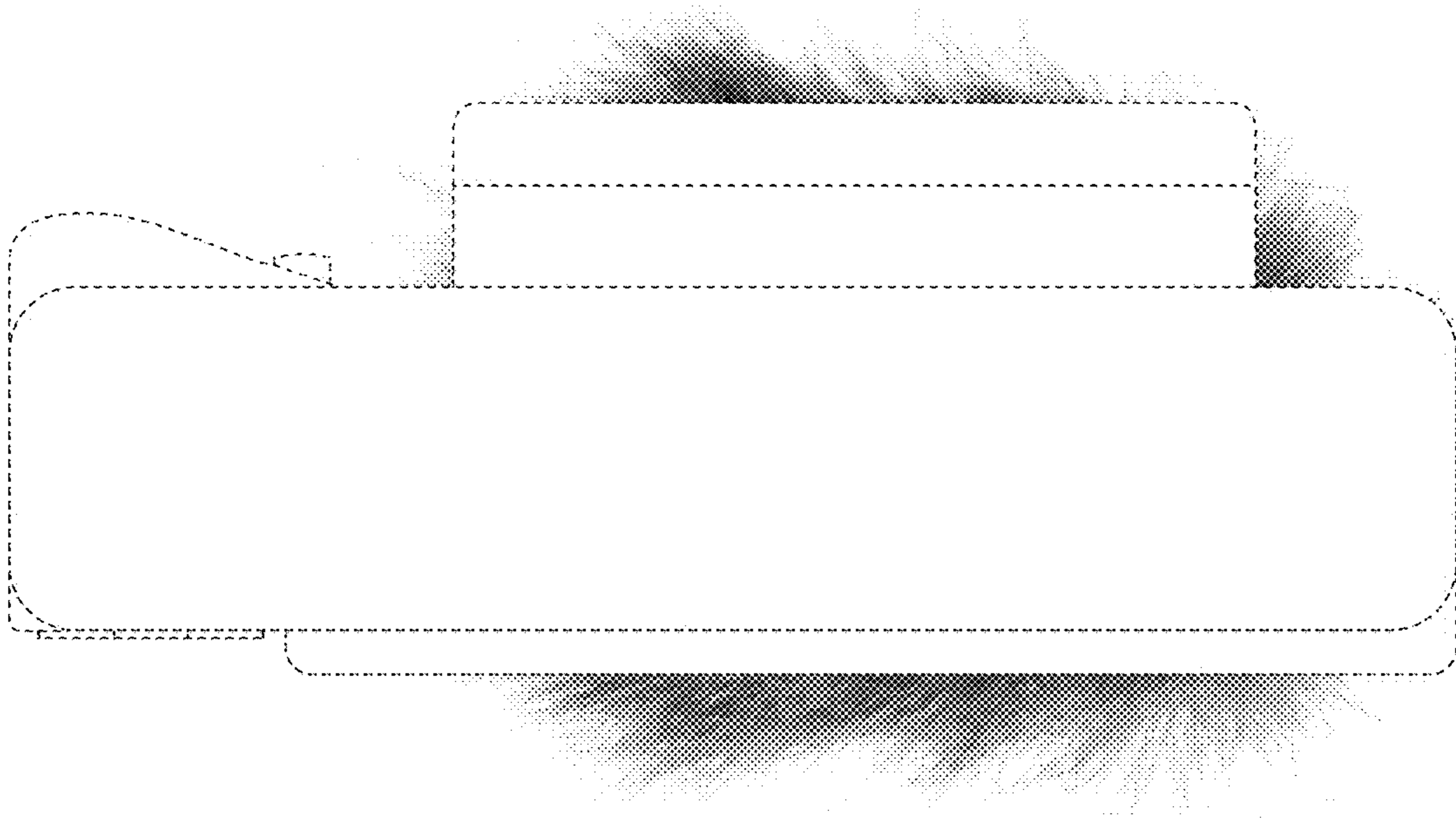

FIG.8



FIG.9

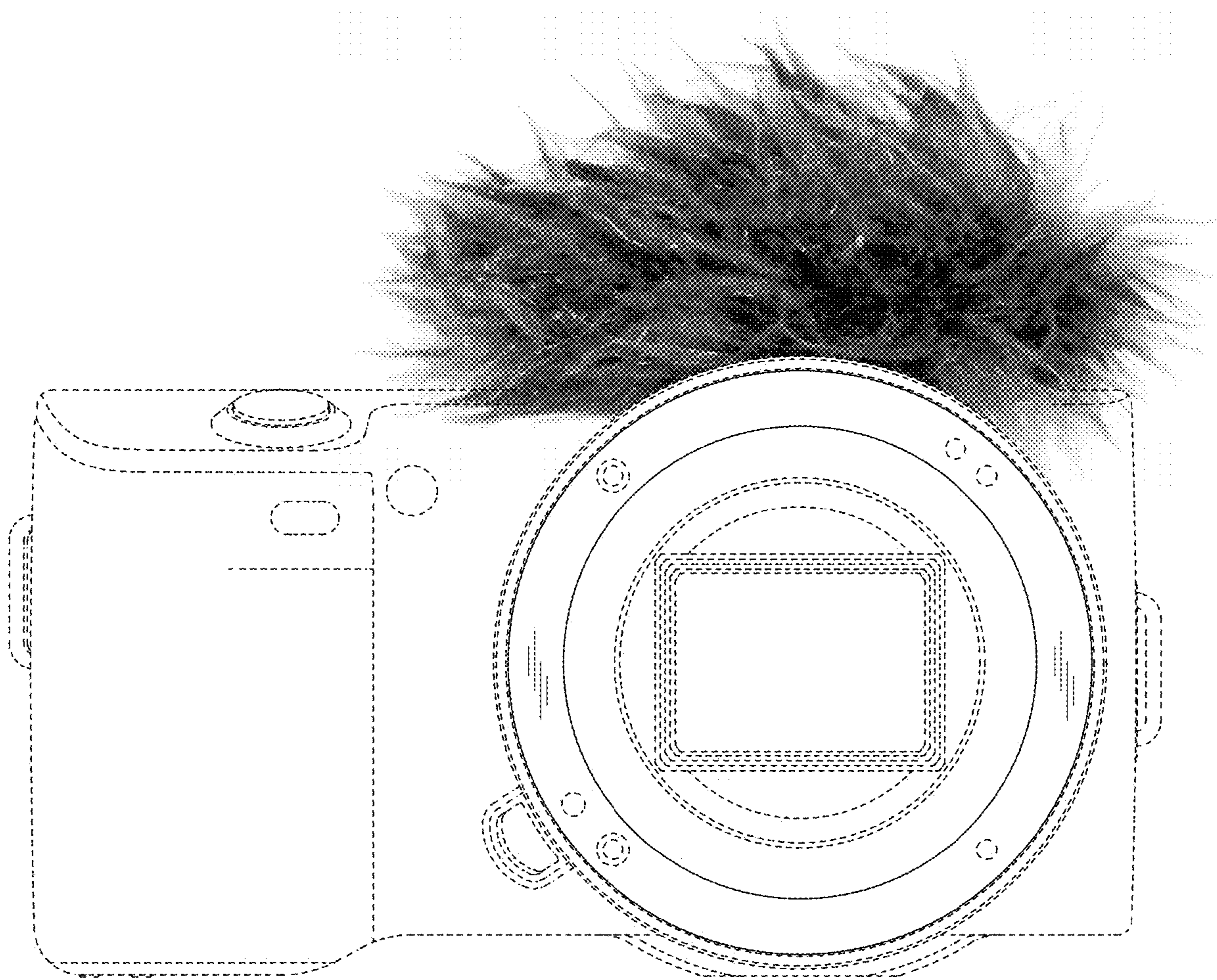

FIG.10

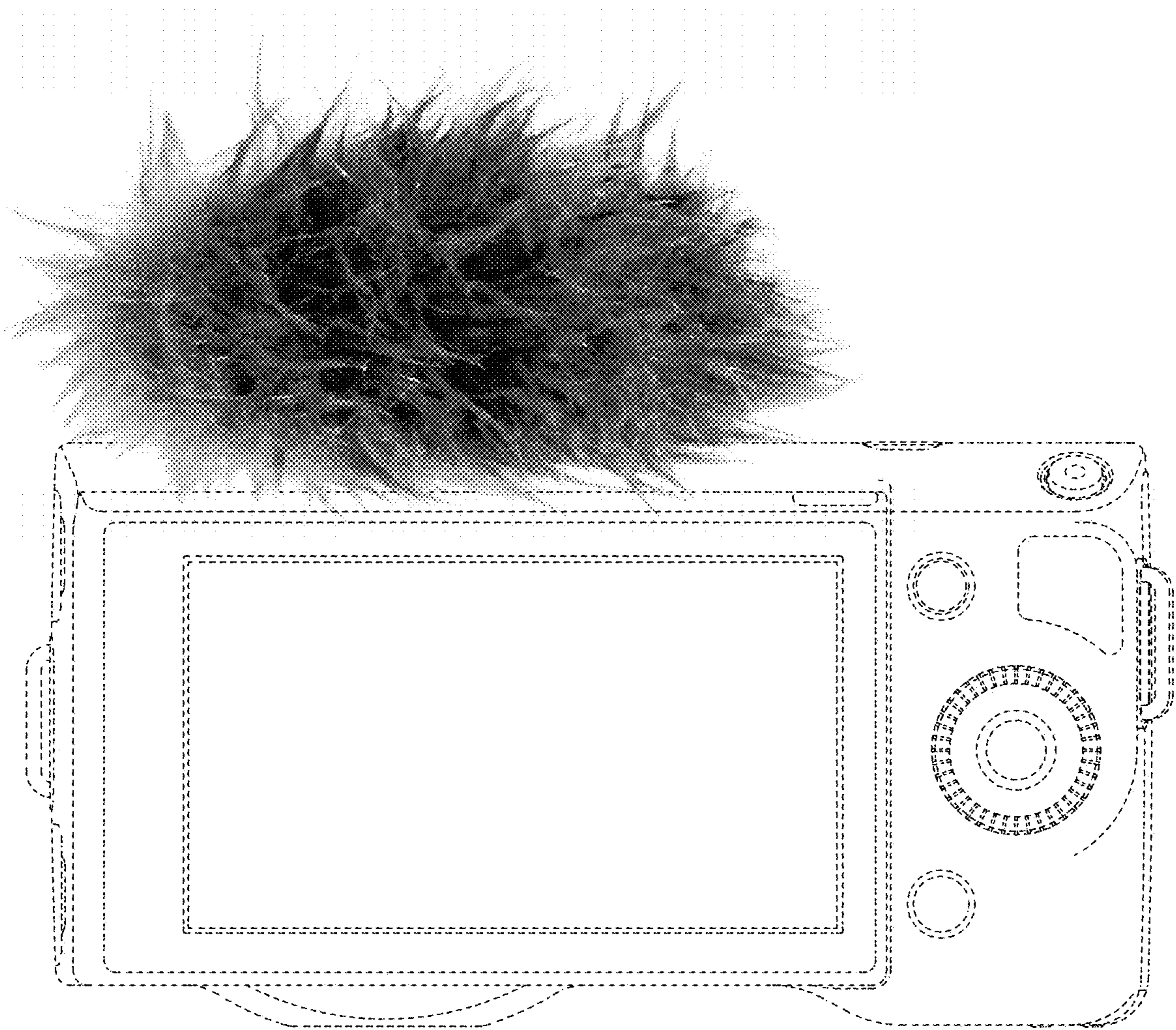

FIG.11

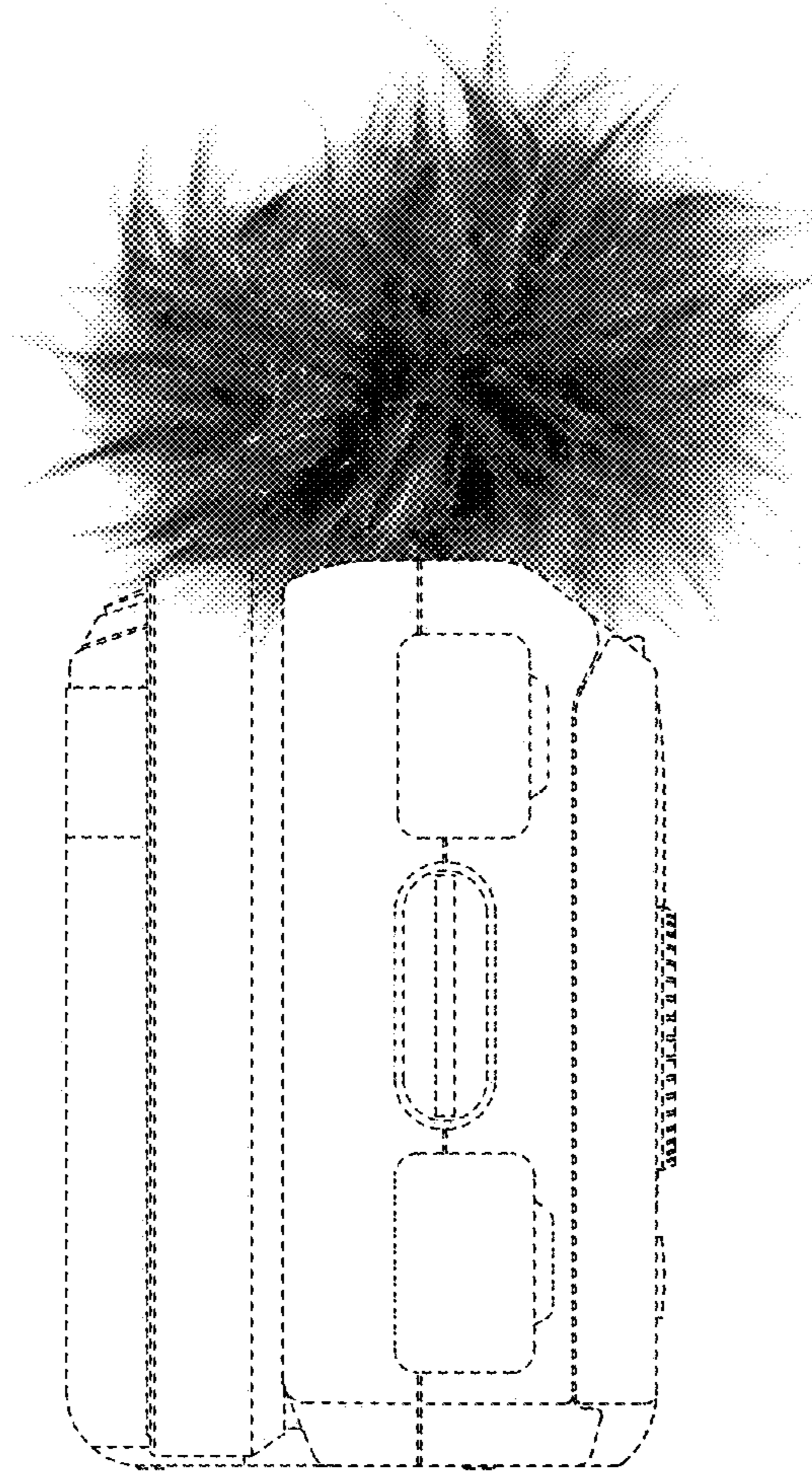

FIG. 12

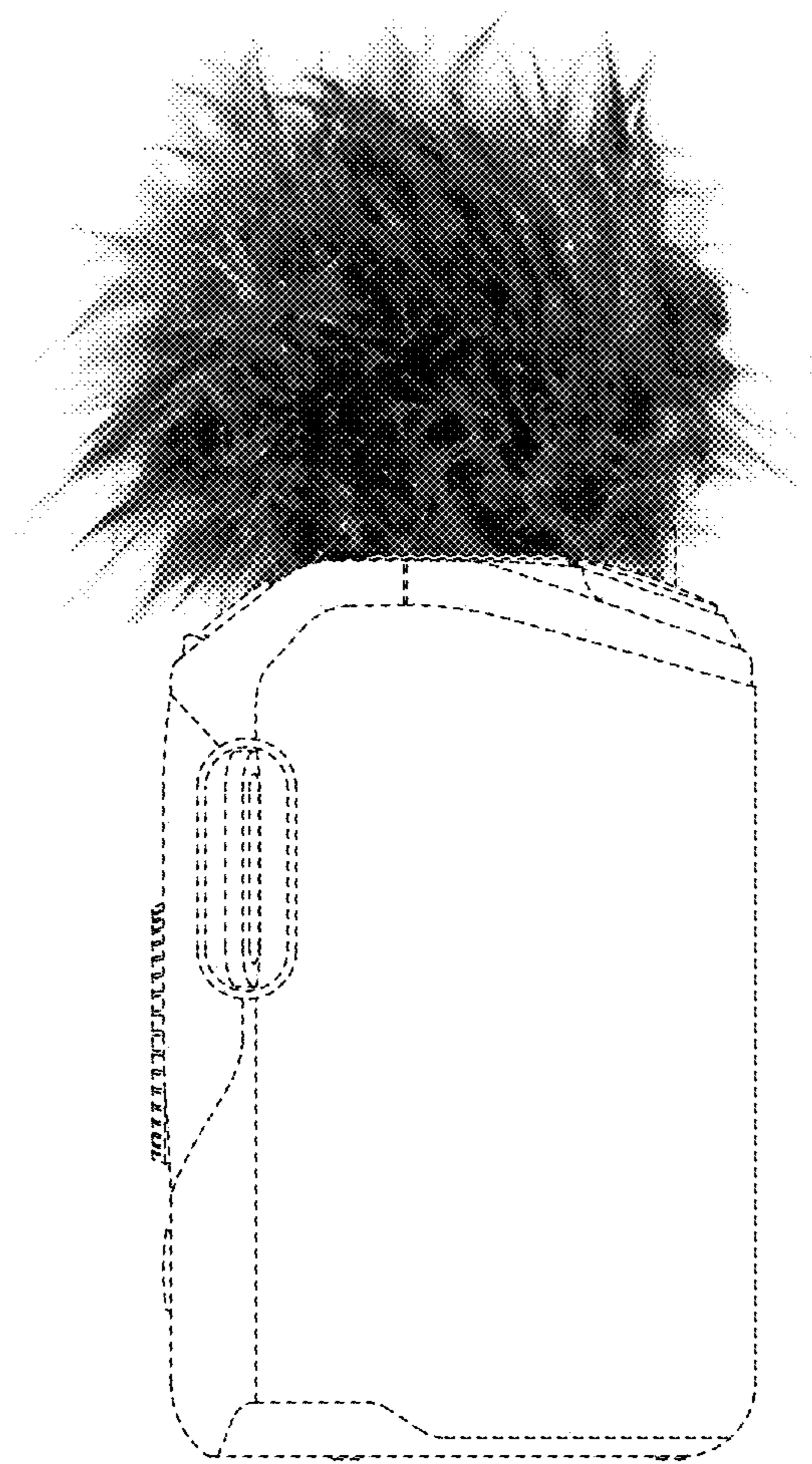

FIG.13

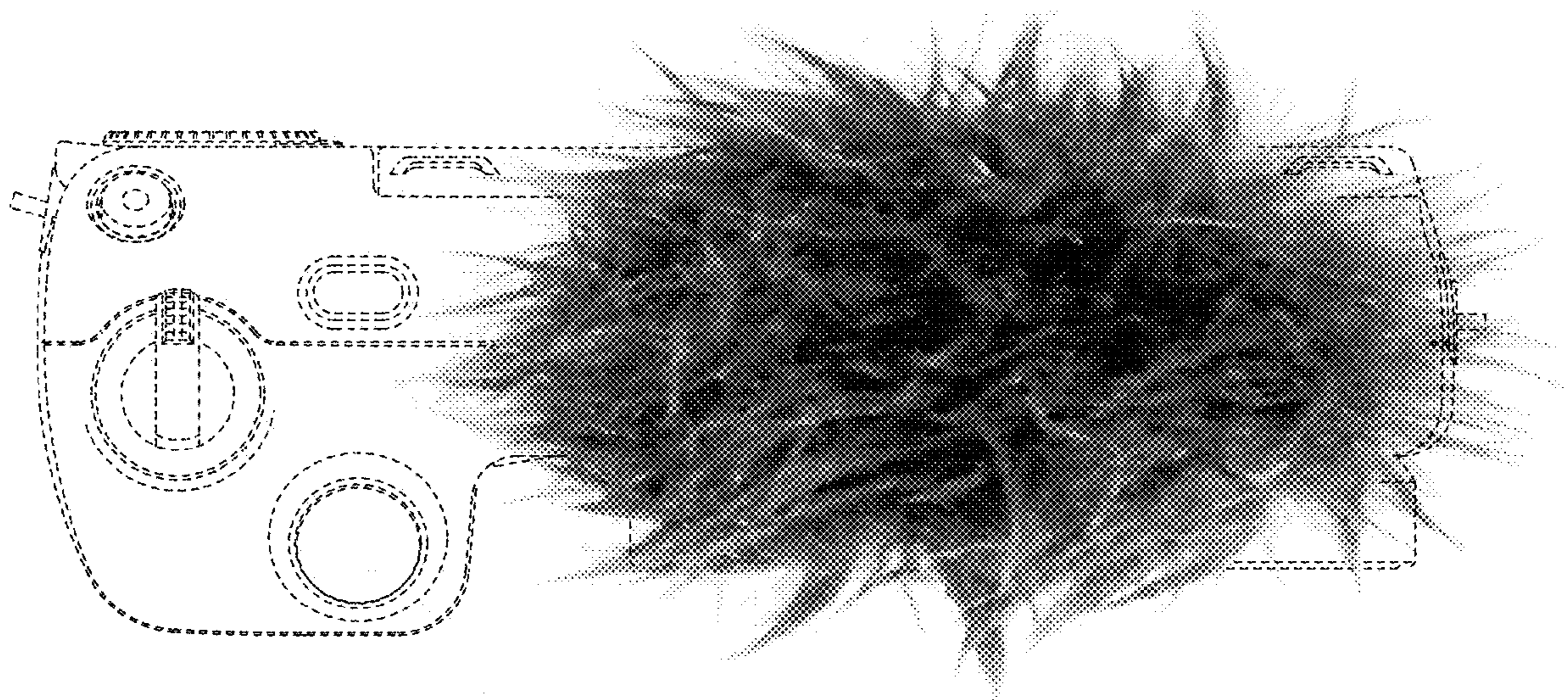

FIG.14

