



US00D958788S

(12) **United States Design Patent**
Chu et al.

(10) **Patent No.:** **US D958,788 S**

(45) **Date of Patent:** **** *Jul. 26, 2022**

(54) **USER INPUT APPARATUS**

(71) Applicant: **Grant & Union Inc.**, Kitchener (CA)

(72) Inventors: **Calvin Chu**, Kitchener (CA); **Sirui Wang**, Mississauga (CA); **Chung-Ming Christopher Tsang**, Scarborough (CA)

(73) Assignee: **Grant & Union Inc.**, Kitchener (CA)

(*) Notice: This patent is subject to a terminal disclaimer.

(**) Term: **15 Years**

(21) Appl. No.: **29/749,883**

(22) Filed: **Sep. 9, 2020**

(51) **LOC (13) Cl.** **14-02**

(52) **U.S. Cl.**
USPC **D14/388**

(58) **Field of Classification Search**
USPC D14/356, 357, 358, 388, 432, 433, 496,
D14/217, 218, 240, 242, 299, 390, 454,
D14/455; D13/158, 159, 123, 124, 162,
D13/162.1, 168, 173, 184, 199, 110, 169,
D13/170, 171; D21/333
CPC . G06F 3/01; G06F 3/02; G06F 3/0362; G06F
3/0338; G06F 3/016; G06F 1/167; G06F
1/1671; G06F 1/169; H04M 1/0254;
H04M 1/0256
See application file for complete search history.

(56) **References Cited**

U.S. PATENT DOCUMENTS

- 3,209,097 A * 9/1965 Shlesinger, Jr. ... H01H 36/0073
335/207
- D288,555 S * 3/1987 Gemmell D13/171
- D305,430 S * 1/1990 Cohen D14/239
- D309,455 S * 7/1990 Staley D14/217
- D316,249 S * 4/1991 King-Pei D13/167
- D323,506 S * 1/1992 Breslau D14/217

- D325,567 S * 4/1992 Jacoby, Jr D13/170
- D337,120 S * 7/1993 Staley D14/239
- D338,015 S * 8/1993 Mohri D14/239
- D338,016 S * 8/1993 Mohri D14/239
- D340,916 S * 11/1993 Imura D13/162
- D341,833 S * 11/1993 MacKay D14/217
- D341,834 S * 11/1993 MacKay D14/217
- D343,622 S * 1/1994 Hanke D14/217
- D349,290 S * 8/1994 Christensen D14/217

(Continued)

FOREIGN PATENT DOCUMENTS

CA 2870914 A1 * 5/2016 G06F 3/01

OTHER PUBLICATIONS

Monogram Creative Console Studio Review, (online) 13 pgs. Posted Dec. 13, 2020. [Retrieved Aug. 27, 2021] <https://www.pcmag.com/reviews/monogram-creative-console-studio>.*

(Continued)

Primary Examiner — Marie D. Fast Horse
(74) *Attorney, Agent, or Firm* — Tai W. Nahm; Nahm IP Law

(57) **CLAIM**

The ornamental design for a user input apparatus, as shown and described.

DESCRIPTION

FIG. 1 is an isometric view of the user input apparatus, showing our new design;
FIG. 2 is a top view thereof;
FIG. 3 is a front view thereof;
FIG. 4 is a left view thereof;
FIG. 5 is a rear view thereof;
FIG. 6 is a right view thereof; and,
FIG. 7 is a bottom view thereof.

The broken lines in the drawings depict portions of the user input apparatus that form no part of the claimed design.

1 Claim, 7 Drawing Sheets

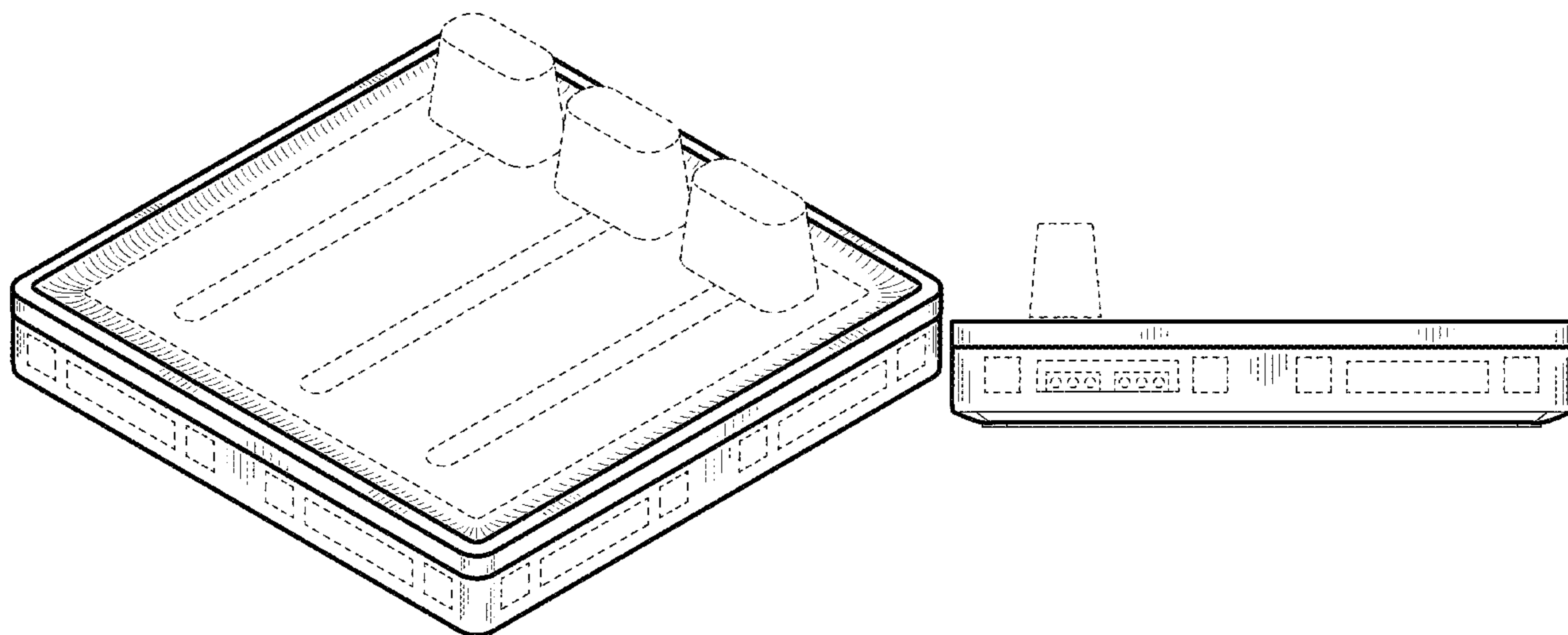

(56)

References Cited

U.S. PATENT DOCUMENTS

D351,599	S *	10/1994	Chui	D14/217	D714,214	S *	9/2014	Wikel	D13/107
D355,655	S *	2/1995	Burke	D14/217	D715,265	S *	10/2014	Kuramoto	D14/217
D359,954	S *	7/1995	Shimizu	D14/388	D715,267	S *	10/2014	Tschetter	D14/217
D364,389	S *	11/1995	Shimizu	D14/389	D718,752	S *	12/2014	Wang	D14/240
D366,261	S *	1/1996	Splane, Jr	D14/217	D719,534	S *	12/2014	Woodman	D13/168
D381,325	S *	7/1997	McMahan	D14/388	D719,924	S *	12/2014	Ueno	D13/171
D385,854	S *	11/1997	Sumii	D14/399	D720,303	S *	12/2014	Fischer	D13/162
D386,500	S *	11/1997	Matsumoto	D14/125	D728,489	S *	5/2015	Eriksen	D13/168
D386,746	S *	11/1997	Su	D13/123	D728,571	S *	5/2015	Perris	D14/399
D395,285	S *	6/1998	Allon	D14/388	D741,819	S *	10/2015	Ueno	D13/171
5,865,546	A *	2/1999	Ganthier	H01H 13/70 400/489	D742,856	S *	11/2015	Skjoldborg	D14/217
D411,530	S *	6/1999	Carter	D14/400	D743,942	S *	11/2015	Tschetter	D14/217
D414,748	S *	10/1999	Pierson	D13/171	D746,794	S *	1/2016	Conrad	D14/218
D417,450	S *	12/1999	Kurachi	D14/168	D747,356	S *	1/2016	Jou	D14/496
D421,011	S *	2/2000	Natori	D14/168	D756,976	S *	5/2016	Jou	D14/242
D421,975	S *	3/2000	Steel	D14/217	D758,217	S *	6/2016	Kumfer	D10/50
D429,233	S *	8/2000	Komiyama	D14/167	D765,058	S *	8/2016	Matsubayashi	D14/217
D434,397	S *	11/2000	Sasago	D14/125	D767,537	S *	9/2016	Matsubayashi	D14/217
D436,878	S *	1/2001	Vassell	D10/104.1	D768,607	S *	10/2016	Altonen	D14/240
D444,493	S *	7/2001	Behringer	D14/217	D771,594	S *	11/2016	Hong	D14/217
D448,756	S *	10/2001	Lewellen	D14/217	D771,595	S *	11/2016	Medas	D14/217
D449,292	S *	10/2001	Miyazaki	D14/217	D780,605	S *	3/2017	Chen	D10/49
D454,552	S *	3/2002	Nakane	D14/168	D789,932	S *	6/2017	Chu	D14/388
D454,855	S *	3/2002	Nakane	D14/168	D791,134	S *	7/2017	Chu	D14/388
D463,401	S *	9/2002	Miyazaki	D14/217	D793,888	S *	8/2017	Hasegawa	D10/106.95
D474,247	S *	5/2003	Miyoshi	D14/400	D803,814	S *	11/2017	Harms	D14/217
D475,050	S *	5/2003	Klein	D14/391	D806,657	S *	1/2018	Russo	D13/168
D484,886	S *	1/2004	Matsuoka	D14/388	D809,942	S *	2/2018	Cool	D10/50
6,703,962	B1 *	3/2004	Marics	A24F 19/105 340/12.55	D811,352	S *	2/2018	Lee	D13/171
D491,563	S *	6/2004	Sato	D14/242	D812,021	S *	3/2018	Lee	D13/171
6,795,318	B2 *	9/2004	Haas	H04M 1/0254 361/728	D815,064	S *	4/2018	Garncarz	D14/217
D496,922	S *	10/2004	Kimura	D14/500	D826,935	S *	8/2018	Son	D14/358
D500,027	S *	12/2004	Takahashi	D14/217	D826,938	S *	8/2018	Son	D14/388
D510,566	S *	10/2005	Johanneck	D13/171	D827,645	S *	9/2018	Raken	D14/388
D512,409	S *	12/2005	Ishizaki	D14/168	D828,816	S *	9/2018	Spors	D13/162
D512,706	S *	12/2005	Nakane	D14/168	D832,822	S *	11/2018	Cho	D14/217
D518,022	S *	3/2006	Ishizaki	D14/168	D834,020	S *	11/2018	Pascucci	D14/399
D520,519	S *	5/2006	Chin	D14/203.3	D839,215	S *	1/2019	Odegard	D13/162
D533,843	S *	12/2006	Larson	D13/162	D839,847	S *	2/2019	Dimberg	D13/171
D539,757	S *	4/2007	Mayo	D13/162	D845,252	S *	4/2019	Arai	D13/158
D540,266	S *	4/2007	Mayo	D13/162	D845,931	S *	4/2019	Kosuge	D14/218
D540,748	S *	4/2007	Larson	D13/162	D846,507	S *	4/2019	Altonen	D13/168
D542,737	S *	5/2007	Spira	D13/162	D846,528	S *	4/2019	Kuramoto	D14/217
D546,295	S *	7/2007	Marchetto	D13/168	D846,529	S *	4/2019	Yang	D14/217
D546,775	S *	7/2007	Mayo	D13/162	D850,411	S *	6/2019	Rowe	D14/217
D553,118	S *	10/2007	Williamson	D14/168	D857,635	S *	8/2019	Prevoteau	D13/162
D553,620	S *	10/2007	Schroeder	D14/217	D870,077	S *	12/2019	Kobayashi	D14/217
D560,203	S *	1/2008	Williamson	D14/168	D870,804	S *	12/2019	Graham	D17/99
D562,259	S *	2/2008	Kosche	D13/162	D872,056	S *	1/2020	Akaishi	D14/217
D578,513	S *	10/2008	Mazur	D14/168	D874,961	S *	2/2020	Friedli	D10/108
D578,514	S *	10/2008	Mazur	D14/168	D875,083	S *	2/2020	Sohn	D14/218
D583,798	S *	12/2008	Iijima	D14/168	D876,356	S *	2/2020	Tanaka	D13/123
D585,036	S *	1/2009	Riggs	D14/126	D881,268	S *	4/2020	Kuramoto	D17/99
D593,544	S *	6/2009	Iijima	D14/217	D883,929	S *	5/2020	Tanaka	D13/123
D607,849	S *	1/2010	Samuels	D13/170	D890,754	S *	7/2020	Raken	D14/388
D614,145	S *	4/2010	Arosio	D13/168	D893,423	S *	8/2020	Nishimura	D13/110
D615,544	S *	5/2010	Pascucci	D14/399	D893,437	S *	8/2020	Dimberg	D13/171
D615,555	S *	5/2010	Ho	D14/496	D895,574	S *	9/2020	Schillebeeckx	D14/217
D616,410	S *	5/2010	Sonoda	D14/168	D902,162	S *	11/2020	Koo	D13/171
D622,257	S *	8/2010	Hansson	D14/168	D910,597	S *	2/2021	Akaishi	D14/217
D624,899	S *	10/2010	Hansson	D14/168	D916,602	S *	4/2021	Ramasamy	D10/49
D628,981	S *	12/2010	Mazur	D14/217	D922,965	S *	6/2021	Altonen	D13/162
D630,616	S *	1/2011	Vex	D14/217	D926,712	S *	8/2021	Dimberg	D13/171
D640,641	S *	6/2011	Felegy, Jr	D13/162	2005/0231642	A1 *	10/2005	Roman	G10H 1/46 348/578
D641,733	S *	7/2011	Jenkins	D14/217	2006/0134978	A1 *	6/2006	Rosen	A63H 33/042 439/581
D644,209	S *	8/2011	Nardin	D14/218	2006/0154711	A1 *	7/2006	Ellis	A63F 13/52 463/1
8,018,726	B2 *	9/2011	Friedlander	H01R 13/514 361/732	2006/0172787	A1 *	8/2006	Ellis	G06N 3/004 463/1
D663,643	S *	7/2012	Saikawa	D10/108	2013/0065407	A1 *	3/2013	Schichl	F42B 4/20 439/39
D687,019	S *	7/2013	O'Donnell	D14/217	2013/0273752	A1 *	10/2013	Rudisill	H01R 11/30 439/39
D689,486	S *	9/2013	O'Donnell	D14/388	2014/0043256	A1 *	2/2014	Wu	H01H 9/02 345/173
D709,124	S *	7/2014	Ridinger	D17/99					

(56)

References Cited

U.S. PATENT DOCUMENTS

2015/0031220 A1* 1/2015 Fang H01R 13/6205
439/38
2015/0104959 A1* 4/2015 Guo H01R 13/506
439/39
2016/0139660 A1* 5/2016 Chu G06F 3/002
345/156

OTHER PUBLICATIONS

Beyond QWERTY_how Palettes knobs and dials change the way you work-play, theverge.com [online] 19 pgs. Posted Feb. 10, 2014 [retrieved on Aug. 25, 2016] <http://www.theverge.com/2014/2/10/5397296/palette-controller>.*
Palette: A modular, roll-your-own take on the software controller(James Holloway). newatlas.com. [online] 19 pgs. Posted Nov. 25, 2013 [retrieved on Aug. 24, 2016] <http://newatlas.com/palette-modular-software-controller/29908/> image galery: <http://newatlas.com/palette-modular-software-controller/29908/pictures>.*
Palette—A Freeform Interface That Controls Any Software—2. (Happy Thanksgiving and Campaign Page Updates) kickstarter.com [online] 5 pgs. Posted Nov. 28, 2013 [retrieved on Aug. 24, 2016]

<https://www.kickstarter.com/projects/cchu/palette-a-freeform-interface-that-controls-any-sof/posts/678241>.*
Palette—A Freeform Interface That Controls Any Software—4.(Palette is Funded! Time for a stretch goal :D) kickstarter.com [online] 4 pgs. Posted Dec. 10, 2013 [retrieved on Aug. 25, 2016] <https://www.kickstarter.com/projects/cchu/palette-a-freeform-interface-that-controls-any-sof/posts/690696>.*
Palette System Like MIDI Controller Lego Blocks, synthtopia.com [online] 15 pgs. Posted Nov. 22, 2013 [retrieved on Aug. 24, 2016] <http://www.synthtopia.com/content/2013/11/22/palette-system-like-midi-controller-lego-blocks/>.*
Controller Breakthrough—The Mawzer Modular MIDI Controller, softpedia.com. [online] 4 pgs. Posted Jun. 12, 2007 [retrieved on Aug. 25, 2016] <http://news.softpedia.com/news/Controller-Breakthrough-The-Mawzer-Modular-MIDI-Controller-57039.shtml> IMGURL: <http://i1-news.softpedia-static.com/images/news2/Controller-Bre>.*
Palette—A Freeform Interface That Controls Any Software—3. (Our first hands-on with Palette!) kickstarter.com [online] 4 pgs. Posted Dec. 6, 2013 [retrieved on Aug. 24, 2016] <https://www.kickstarter.com/projects/cchu/palette-a-freeform-interface-that-controls-any-sof/posts/686425>.*
Introducing Monogram—A Modular Productivity Tool For Creative Pros, (online video) 1 pg. Posted Sep. 16, 2019. [Retrieved Aug. 27, 2021] <https://www.youtube.com/watch?v=B0glGft2SAo>.*

* cited by examiner

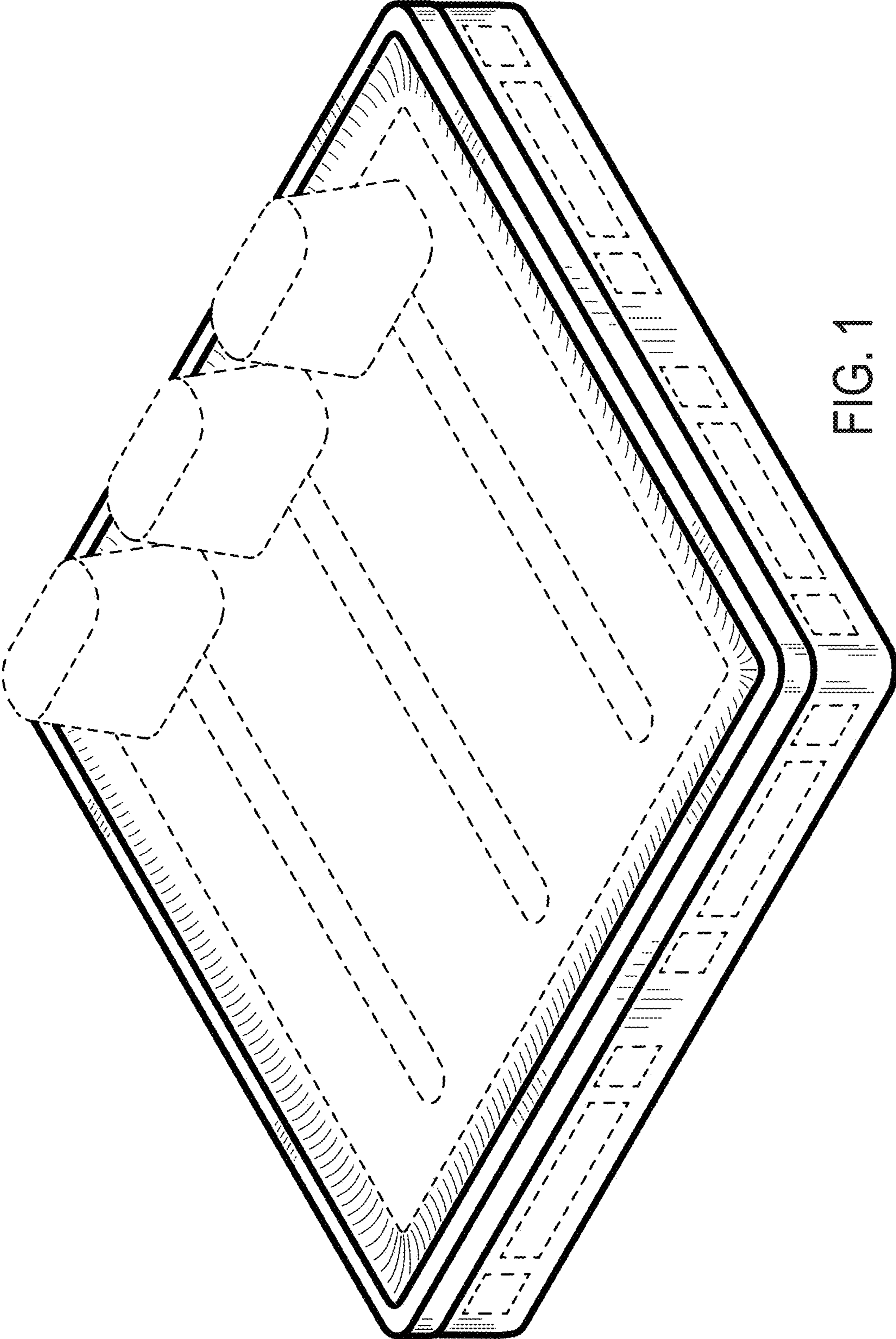

FIG. 1

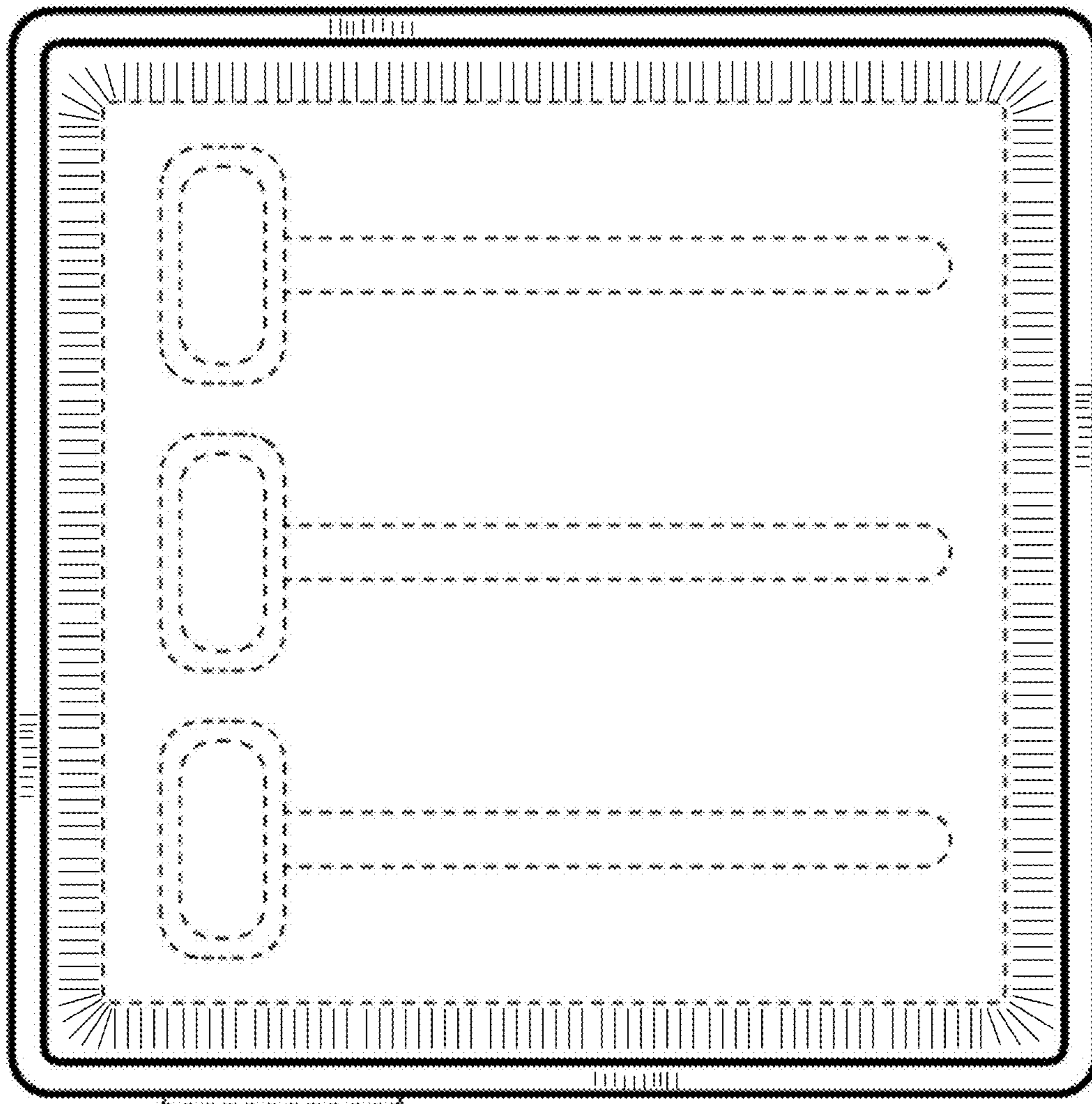

FIG. 2

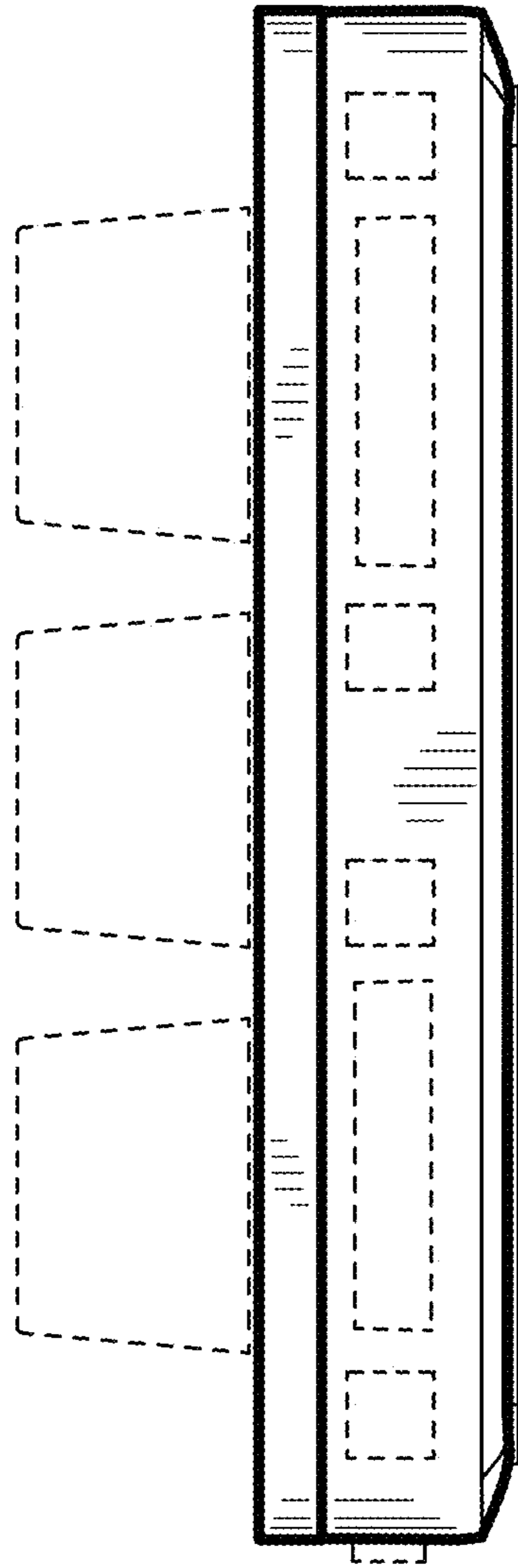

FIG. 3

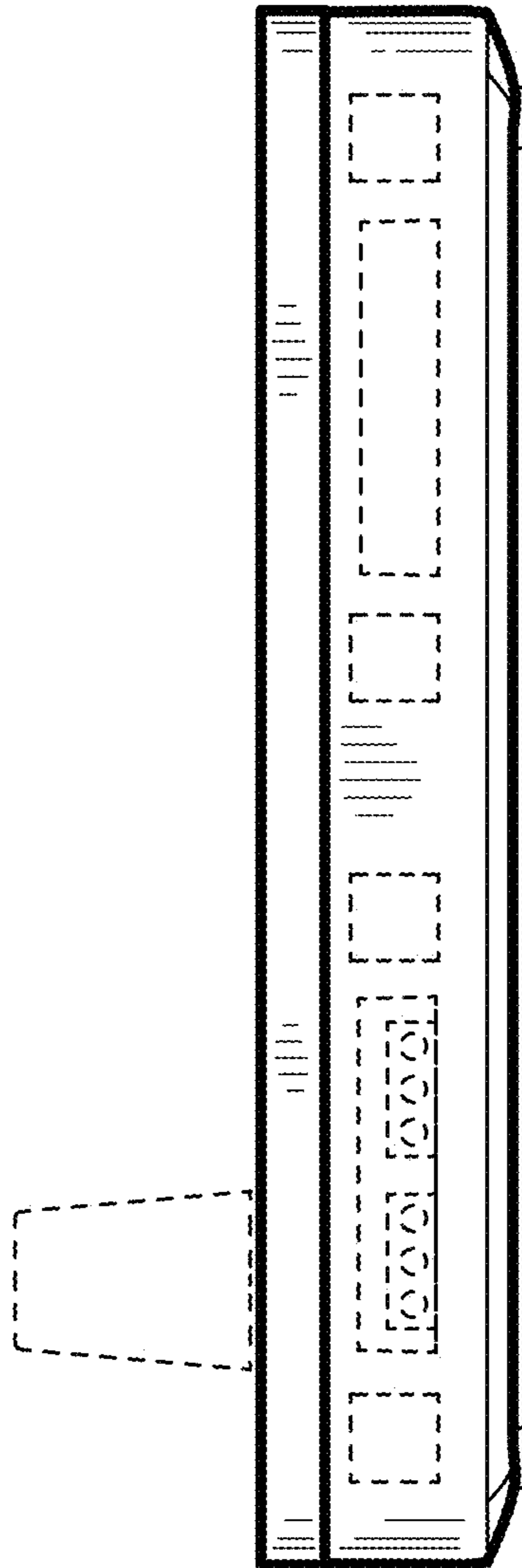

FIG. 4

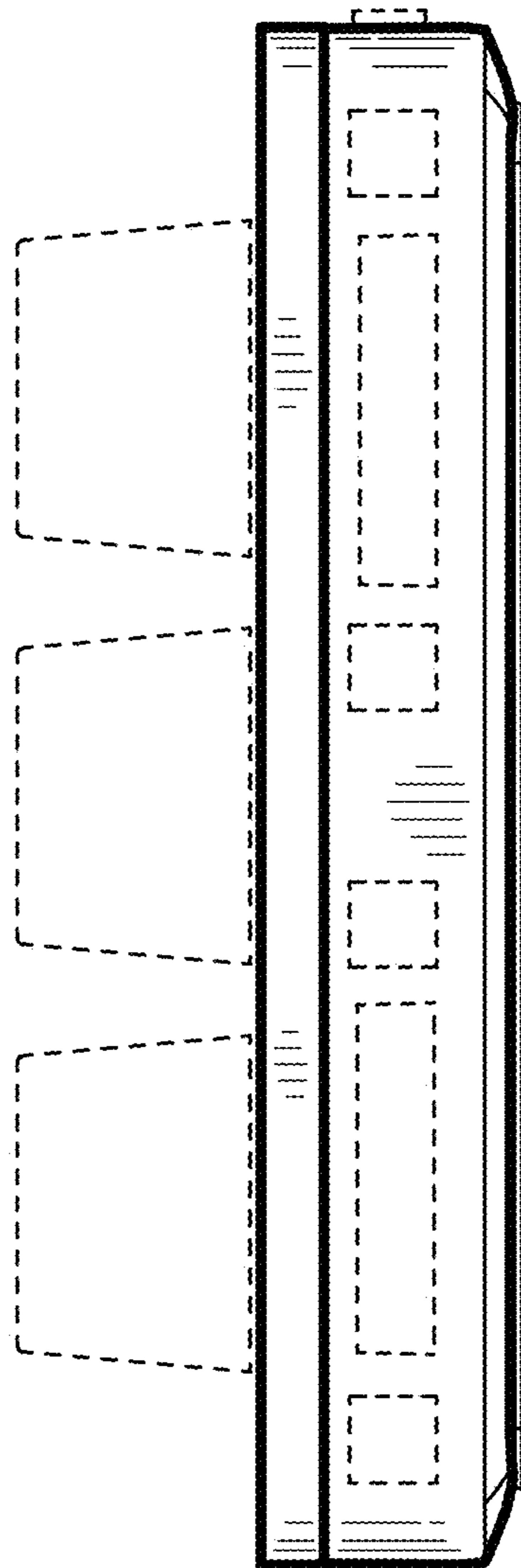

FIG. 5

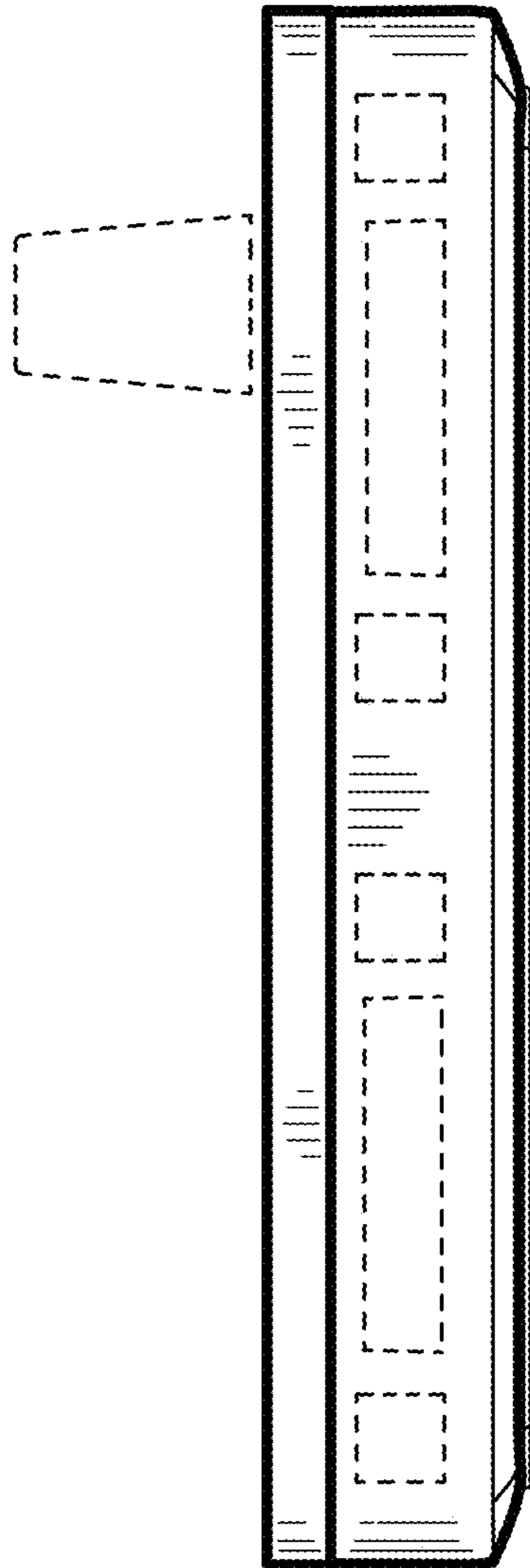

FIG. 6

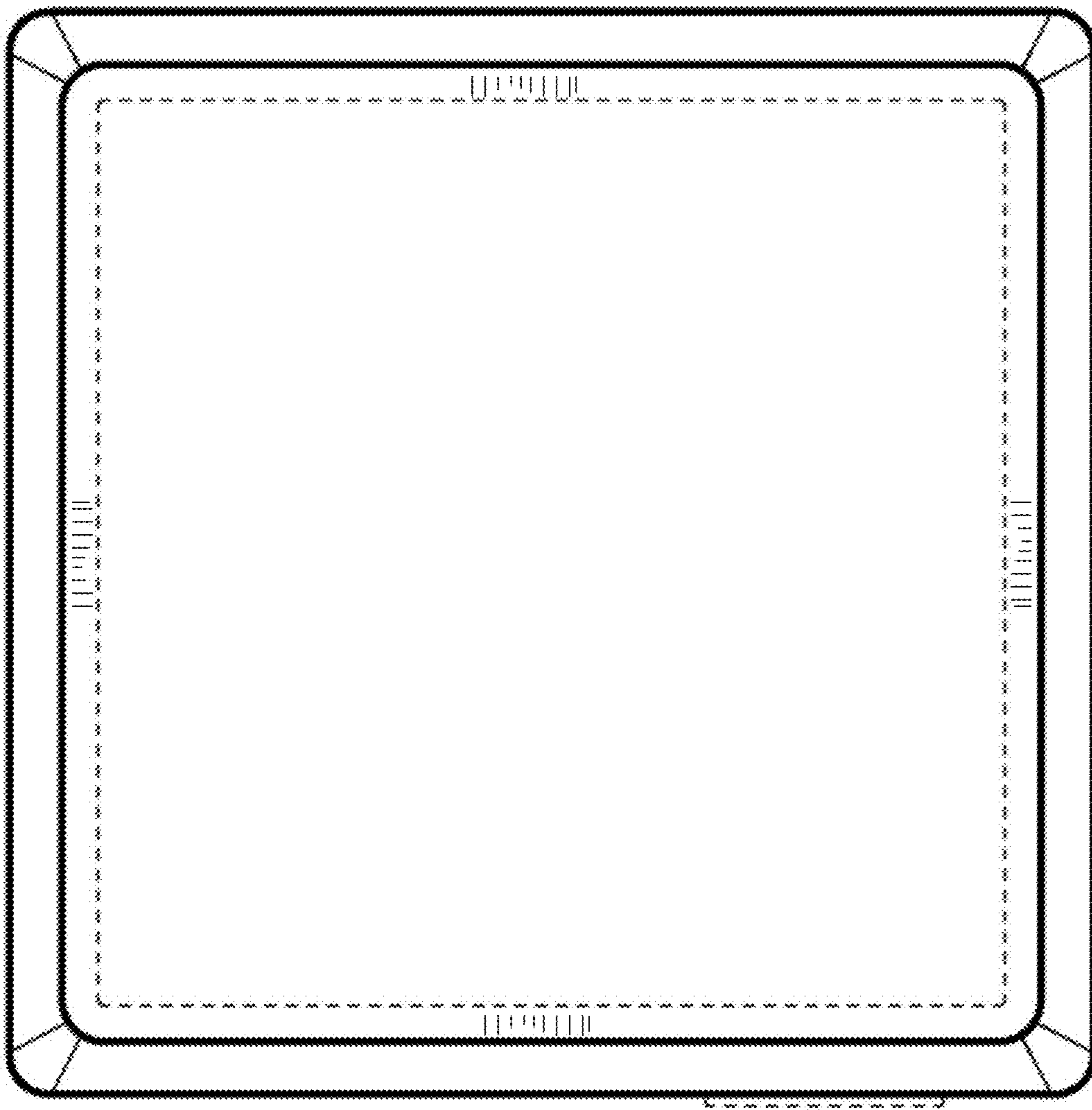

FIG. 7