



US00D958780S

(12) **United States Design Patent**  
**Choi et al.**

(10) **Patent No.:** **US D958,780 S**  
(45) **Date of Patent:** **\*\* Jul. 26, 2022**

(54) **ELECTRONIC DEVICE**

(71) Applicant: **Samsung Electronics Co., Ltd.**,  
Suwon-si (KR)  
(72) Inventors: **Hyok-Su Choi**, Suwon-si (KR);  
**Jong-Bo Jung**, Suwon-si (KR);  
**Ji-Young Lee**, Suwon-si (KR)  
(73) Assignee: **SAMSUNG ELECTRONICS CO.,**  
**LTD.**, Suwon-si (KR)

(\*\*) Term: **15 Years**

(21) Appl. No.: **29/732,686**

(22) Filed: **Apr. 27, 2020**

(30) **Foreign Application Priority Data**

Mar. 19, 2020 (KR) ..... 30-2020-0012310

(51) **LOC (13) Cl.** ..... **14-03**

(52) **U.S. Cl.**  
USPC ..... **D14/248**

(58) **Field of Classification Search**  
USPC ..... D14/248, 138 C, 138 R, 138 AC,  
D14/138 AD, 38 AA, 138 G, 426,  
(Continued)

(56) **References Cited**

**U.S. PATENT DOCUMENTS**

D540,773 S \* 4/2007 Meng ..... D14/138 AA  
D546,306 S \* 7/2007 Lee ..... D14/138 AB  
(Continued)

**FOREIGN PATENT DOCUMENTS**

CN 306019184 \* 8/2020  
CN 306769063 \* 2/2021  
(Continued)

**OTHER PUBLICATIONS**

gsmarena.com, vivo S10 Pro—Full phone specifications, announced  
Jun. 15, 2021 [online], site visited [Dec. 16, 2021], internet URL:  
https://www.gsmarena.com/vivo\_s10\_pro-11003.php (Year: 2021).\*  
(Continued)

*Primary Examiner* — Wendy L Arminio  
*Assistant Examiner* — Carrie S Gelula  
(74) *Attorney, Agent, or Firm* — McAndrews Held &  
Malloy, Ltd.

(57) **CLAIM**

The ornamental design for an electronic device, as shown  
and described.

**DESCRIPTION**

FIG. 1 is a front perspective view of an electronic device  
showing our new design according to a first embodiment;  
FIG. 2 is a front elevation view thereof;  
FIG. 3 is a rear elevation view thereof;  
FIG. 4 is a left side elevation view thereof;  
FIG. 5 is a right side elevation view thereof;  
FIG. 6 is a top plan view thereof;  
FIG. 7 is a bottom plan view thereof;  
FIG. 8 is a rear perspective view thereof;  
FIG. 9 is a front perspective view of an electronic device  
showing our new design according to a second embodiment;  
FIG. 10 is a front elevation view thereof;  
FIG. 11 is a rear elevation view thereof;  
FIG. 12 is a left side elevation view thereof;  
FIG. 13 is a right side elevation view thereof;  
FIG. 14 is a top plan view thereof;  
FIG. 15 is a bottom plan view thereof; and,  
FIG. 16 is a rear perspective view thereof.  
The dashed broken lines in the figures illustrate portions of  
the electronic device that form no part of the claimed design.  
The figures are illustrated to show contrasting appearance.  
Areas of the electronic device that appear in different shades  
of gray represent areas with contrasting appearances.

**1 Claim, 16 Drawing Sheets**

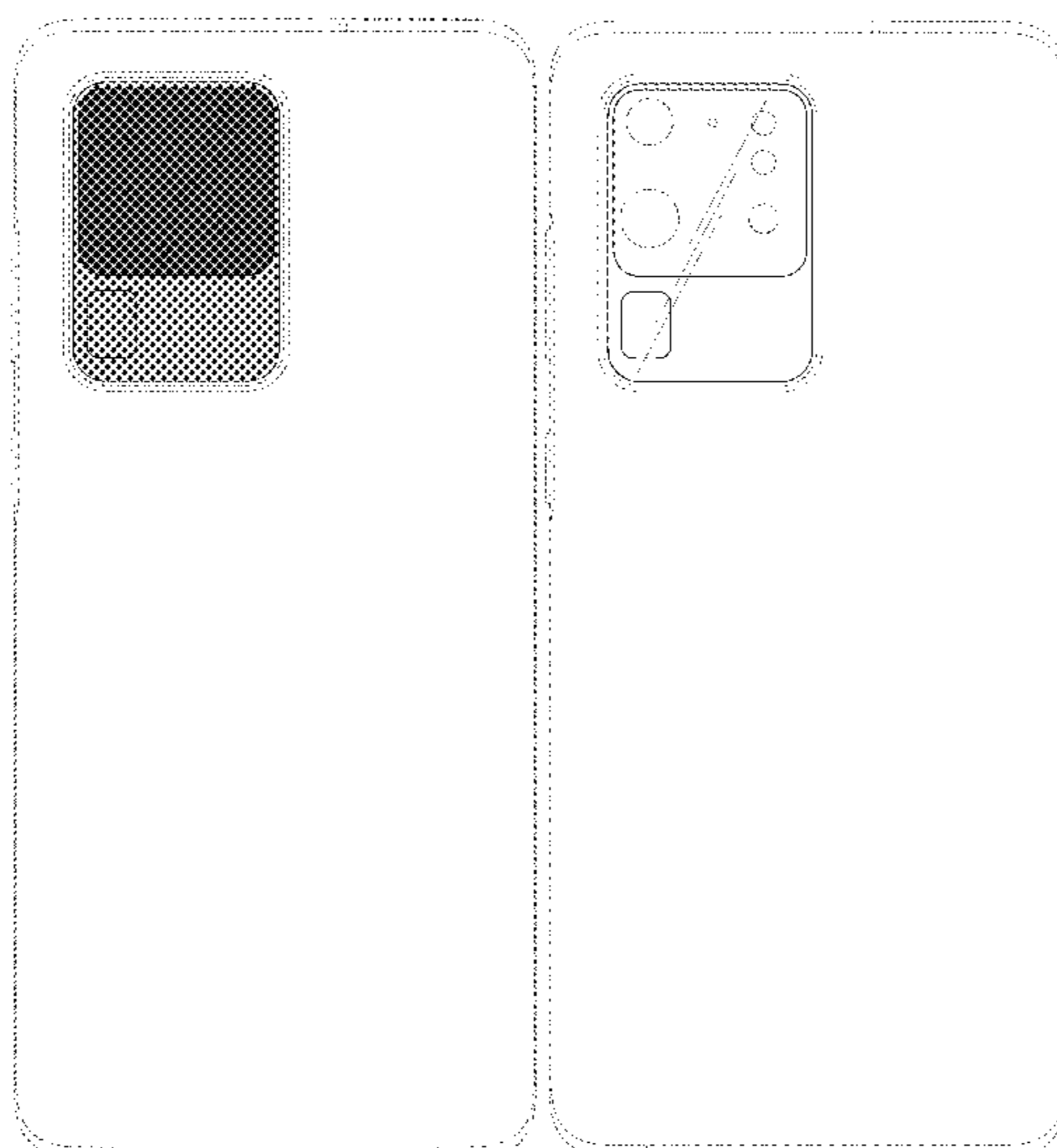

(58) **Field of Classification Search**

USPC ..... D14/341–345; D10/30–38, 98; D16/244,  
D16/245; D24/167, 186

CPC ... H04N 5/2257; G06F 1/1686; G06F 1/1605;  
H01L 27/3232; G02B 13/001; H04M  
1/0264

See application file for complete search history.

(56) **References Cited**

U.S. PATENT DOCUMENTS

D560,630 S \* 1/2008 Mitchell ..... D14/138 AA  
D579,898 S \* 11/2008 Lee ..... D14/138 G  
D579,902 S \* 11/2008 Kim ..... D14/138 AD  
D585,411 S \* 1/2009 Eaton ..... D14/138 G  
D590,822 S \* 4/2009 Leith ..... D14/248  
D599,338 S \* 9/2009 Eguchi ..... D14/248  
D601,116 S \* 9/2009 Baik ..... D14/138 AA  
D602,463 S \* 10/2009 Eguchi ..... D14/138 G  
D603,388 S \* 11/2009 Tompkin ..... D14/248  
D618,228 S \* 6/2010 Oh ..... D14/248  
D624,037 S \* 9/2010 Yun ..... D14/138 AB  
D629,772 S \* 12/2010 Mo ..... D14/138 G  
D633,064 S \* 2/2011 Kim ..... D14/138 AD  
D645,436 S \* 9/2011 Chung ..... D14/138 G  
D647,871 S \* 11/2011 Han ..... D14/138 AB  
D651,187 S \* 12/2011 Hwang ..... D14/138 G  
D714,783 S \* 10/2014 Takizawa ..... D14/341  
D715,282 S \* 10/2014 Chang ..... D14/248  
D725,069 S \* 3/2015 Choe ..... D14/138 G  
D725,641 S \* 3/2015 Joung ..... D14/248  
D728,506 S \* 5/2015 Joung ..... D14/138 G  
D730,884 S \* 6/2015 Shin ..... D14/248  
D739,367 S \* 9/2015 Choi ..... D14/248  
D739,370 S \* 9/2015 Chang ..... D14/138 G  
D740,795 S \* 10/2015 Chang ..... D14/248  
D742,865 S \* 11/2015 Choi ..... D14/248  
D751,050 S \* 3/2016 Song ..... D14/138 G  
D762,608 S \* 8/2016 Yoon ..... D14/138 G  
D762,611 S \* 8/2016 Lee ..... D14/138 G  
D762,627 S \* 8/2016 Yoon ..... D14/248  
D767,523 S \* 9/2016 Zhang ..... D14/138 G  
D773,456 S \* 12/2016 Mitchell ..... D14/341  
D782,453 S \* 3/2017 Kim ..... D14/248  
D793,389 S \* 8/2017 Kim ..... D14/341  
D794,803 S \* 8/2017 Thom ..... D24/169  
D795,860 S \* 8/2017 Rak ..... D14/341  
D813,216 S \* 3/2018 Lee ..... D14/248  
D824,375 S \* 7/2018 Kim ..... D14/248  
D831,605 S \* 10/2018 Baik ..... D14/138 G  
D834,008 S \* 11/2018 Cho ..... D14/248  
D839,250 S \* 1/2019 Baik ..... D14/248

D839,251 S \* 1/2019 Baik ..... D14/248  
D840,960 S \* 2/2019 Bishop ..... D14/126  
D842,722 S \* 3/2019 Lee ..... D10/70  
10,560,562 B1 \* 2/2020 Tandon ..... H04M 1/724  
D877,145 S \* 3/2020 Shin ..... D14/344  
D910,608 S \* 2/2021 Tandon ..... D14/248  
D933,235 S \* 10/2021 Hwang ..... D24/167  
2008/0268901 A1 \* 10/2008 Miramontes ..... H04M 1/0247  
455/556.1  
2020/0260049 A1 \* 8/2020 Erna ..... H04N 7/15  
2021/0167110 A1 \* 6/2021 Roh ..... H01L 27/146  
2021/0251083 A1 \* 8/2021 Jung ..... H05K 1/0274  
2021/0281729 A1 \* 9/2021 Queeney ..... G06F 1/1633  
2021/0352220 A1 \* 11/2021 Kim ..... H04M 1/725

FOREIGN PATENT DOCUMENTS

CN 306391421 \* 3/2021  
CN 306550785 \* 5/2021  
CN 306686994 \* 7/2021  
CN 306761068 \* 8/2021  
CN 306769094 \* 8/2021  
CN 306810581 \* 9/2021  
CN 306810602 \* 9/2021  
CN 306855651 \* 9/2021  
CN 306881038 \* 10/2021  
CN 306915351 \* 11/2021  
WO WO-D205682-006 \* 7/2020  
WO WO-D205683-003 \* 7/2020  
WO WO-D217236-001 \* 11/2021

OTHER PUBLICATIONS

gsmarena.com, vivo Y52s t1—Full phone specifications, announced May 3, 2021 [online], site visited [Dec. 16, 2021], internet URL: [https://www.gsmarena.com/vivo\\_y52s\\_t1-10889.php](https://www.gsmarena.com/vivo_y52s_t1-10889.php) (Year: 2021).\*

gsmarena.com, Oppo Reno5 F—Full phone specifications, announced Mar. 17, 2021 [online], site visited [Dec. 16, 2021], internet URL: [https://www.gsmarena.com/oppo\\_reno5\\_f-10763.php](https://www.gsmarena.com/oppo_reno5_f-10763.php) (Year: 2021).\*

gsmarena.com, Meizu 18 Pro—Full phone specifications, announced Mar. 3, 2021 [online], site visited [Dec. 16, 2021], internet URL: [https://www.gsmarena.com/meizu\\_18\\_pro-10751.php](https://www.gsmarena.com/meizu_18_pro-10751.php) (Year: 2021).\*

gsmarena.com, Samsung Galaxy S20 Ultra 5g—Full phone specifications, announced Feb. 11, 2021 [online], site visited [Dec. 16, 2021], internet URL: [https://www.gsmarena.com/samsung\\_galaxy\\_s20\\_ultra\\_5g-10040.php](https://www.gsmarena.com/samsung_galaxy_s20_ultra_5g-10040.php) (Year: 2021).\*

gsmarena.com, Samsung Galaxy S20 Ultra—Full phone specifications, announced Feb. 11, 2021 [online], site visited [Dec. 16, 2021], internet URL: [https://www.gsmarena.com/samsung\\_galaxy\\_s20\\_ultra-10084.php](https://www.gsmarena.com/samsung_galaxy_s20_ultra-10084.php) (Year: 2021).\*

\* cited by examiner

FIG. 1

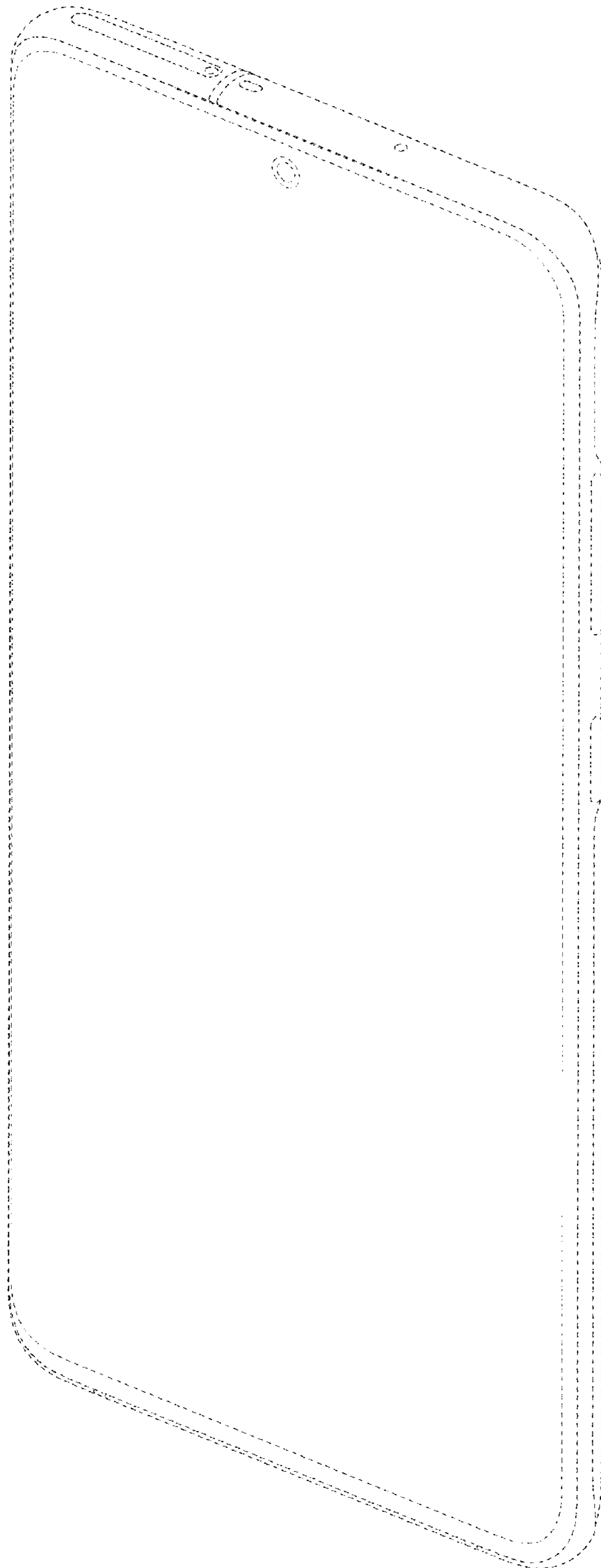

FIG. 2

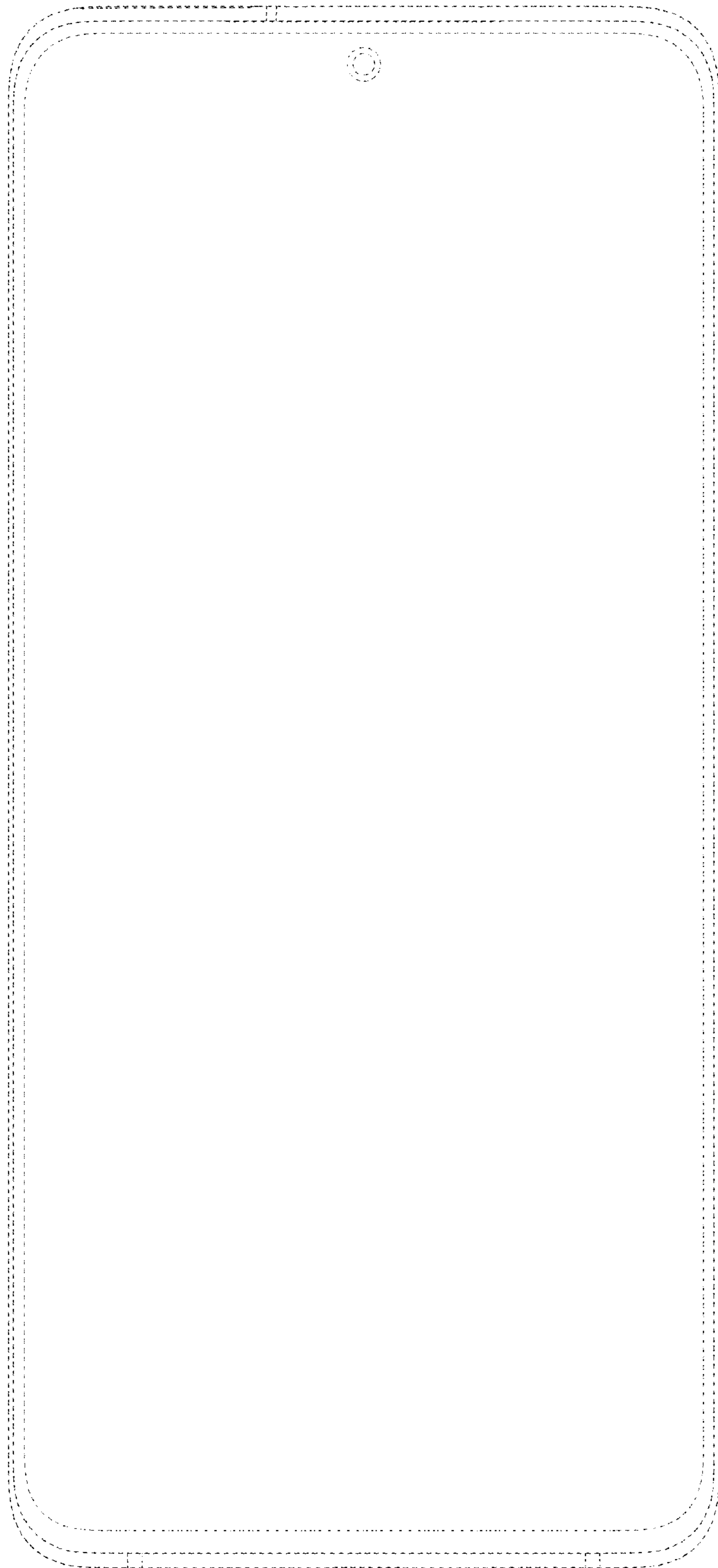

FIG. 3

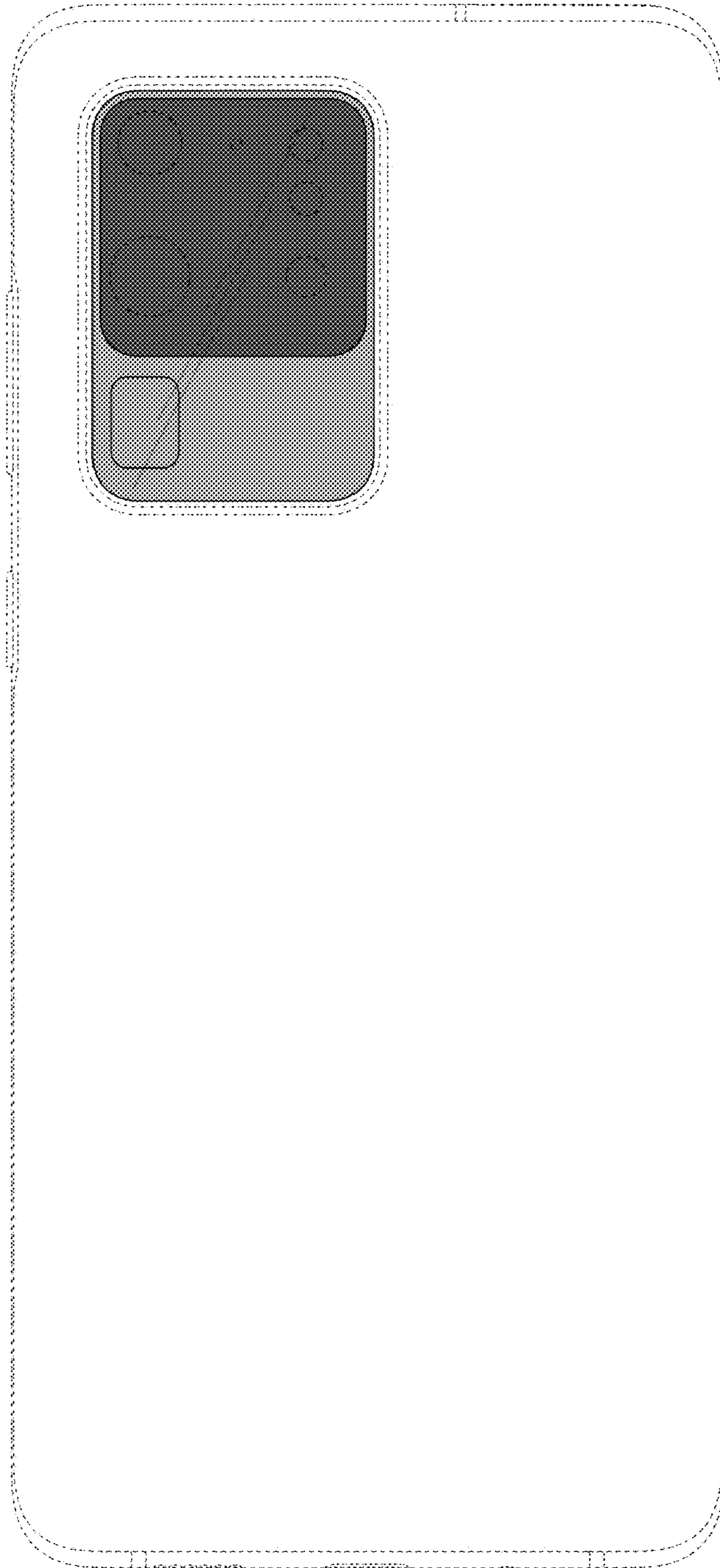

FIG. 4

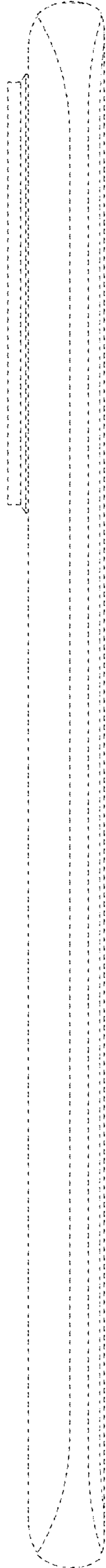

FIG. 5

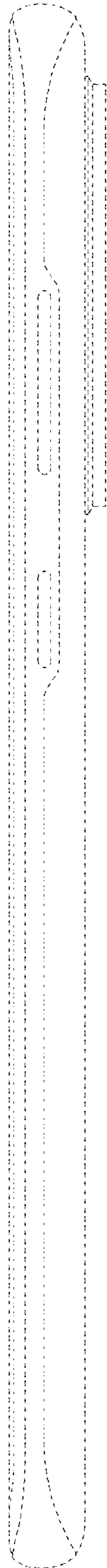

FIG. 6

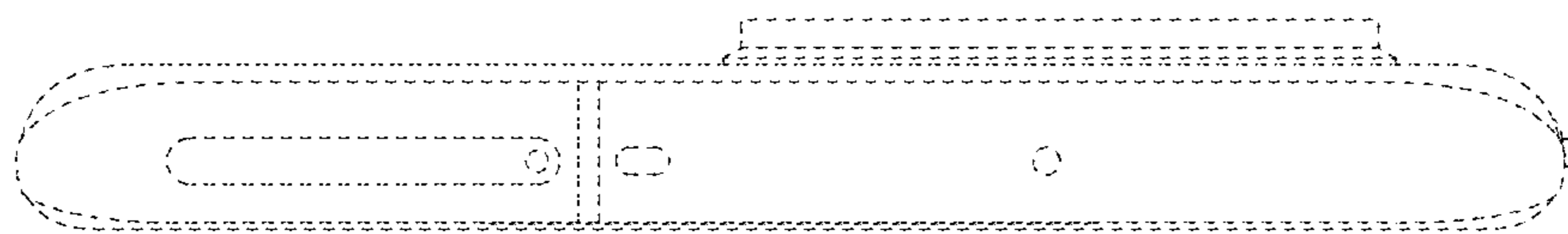



FIG. 7

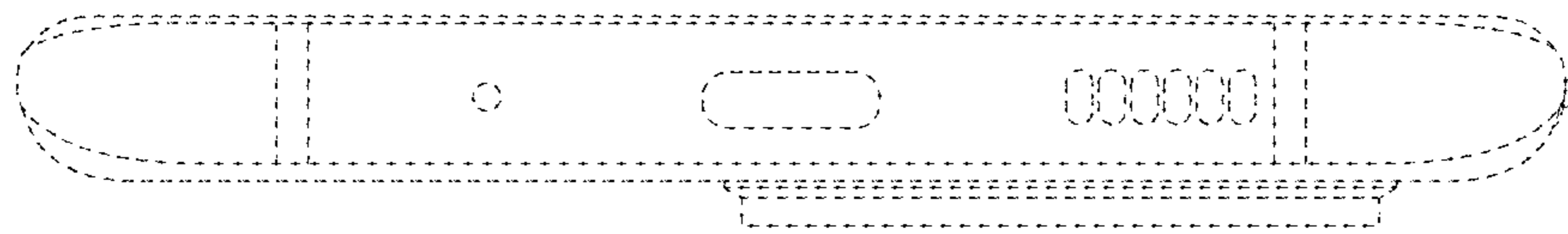

FIG. 8

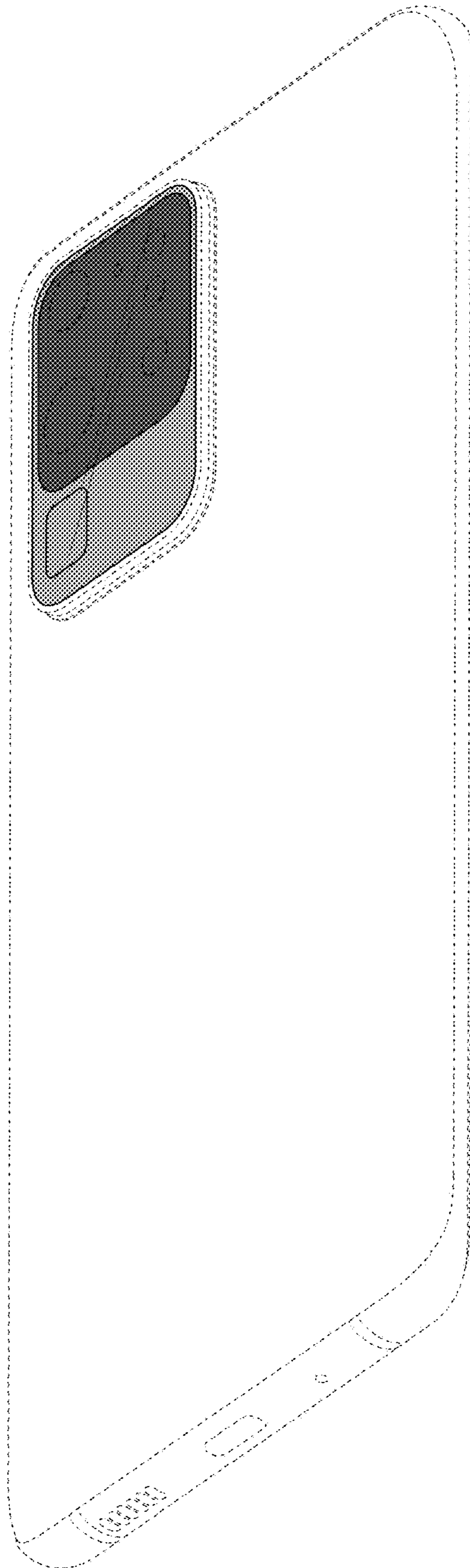

FIG. 9

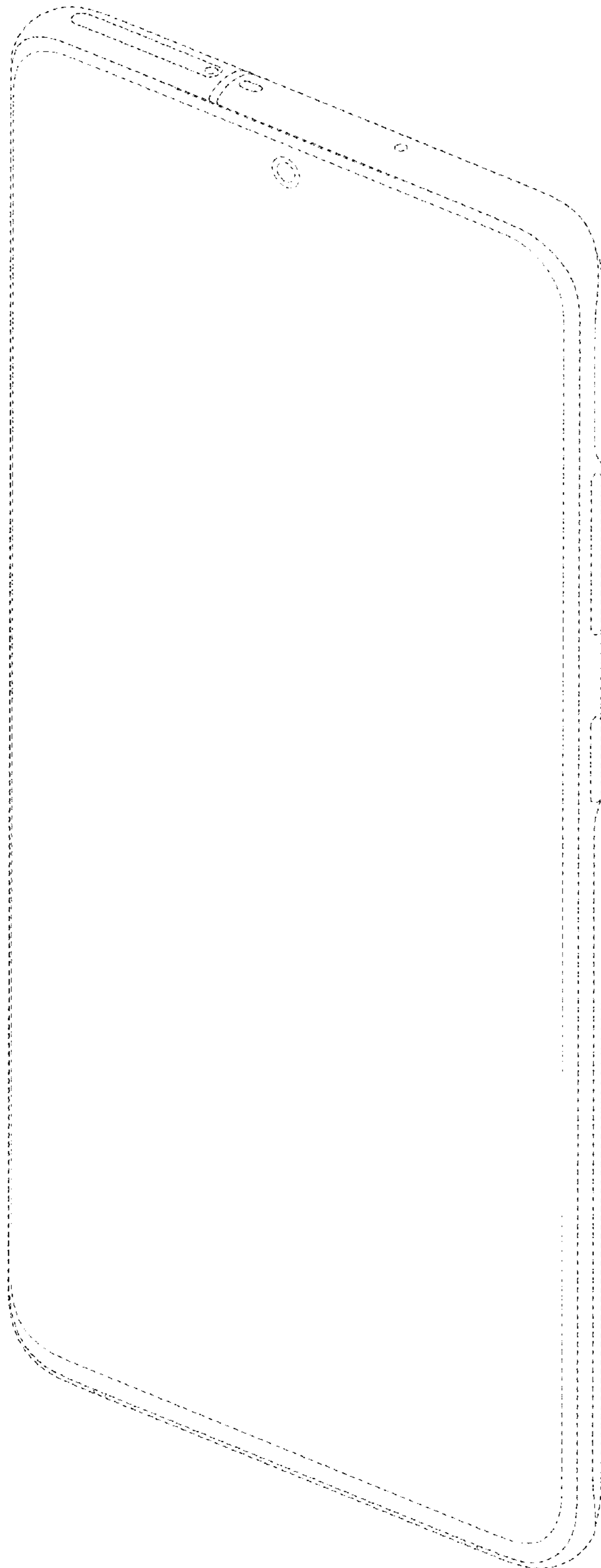

FIG. 10

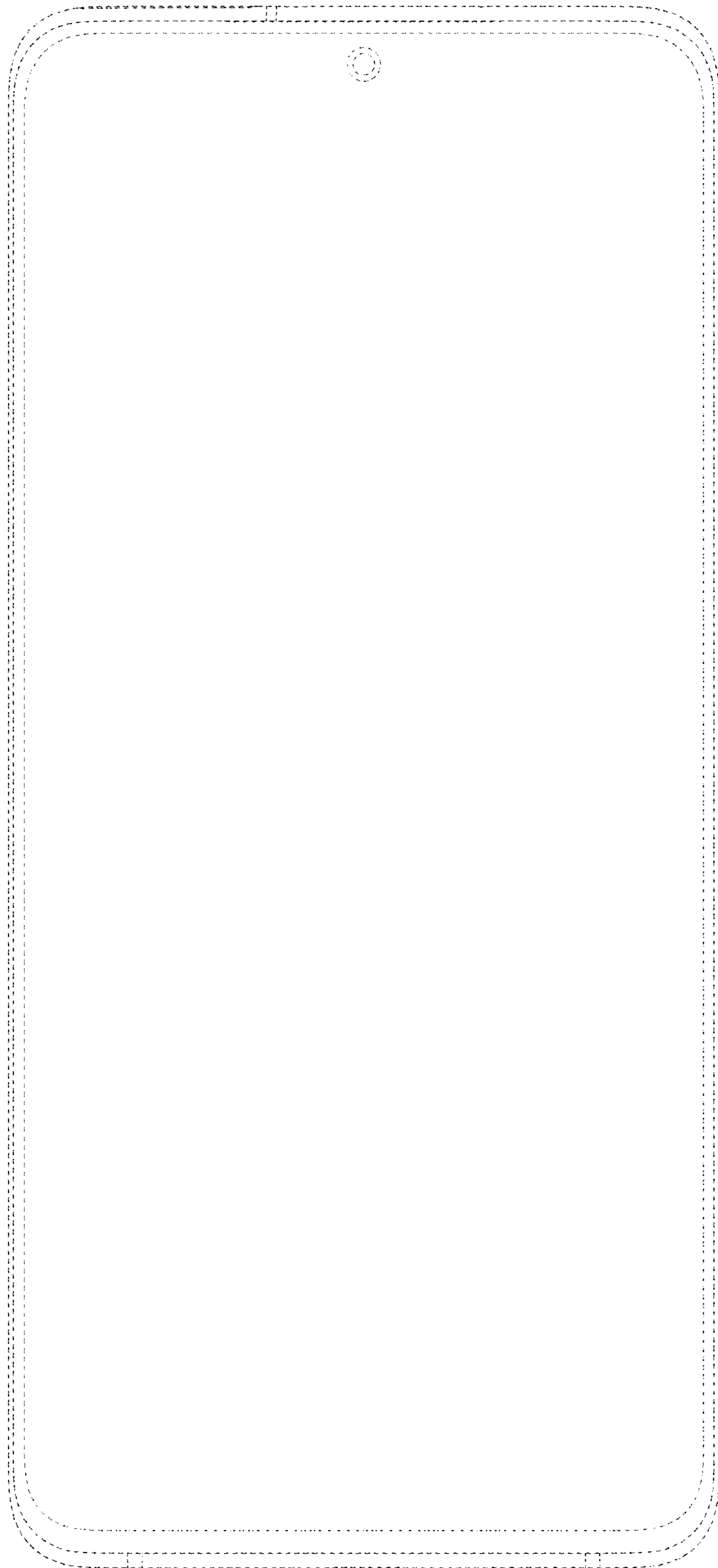

FIG. 11

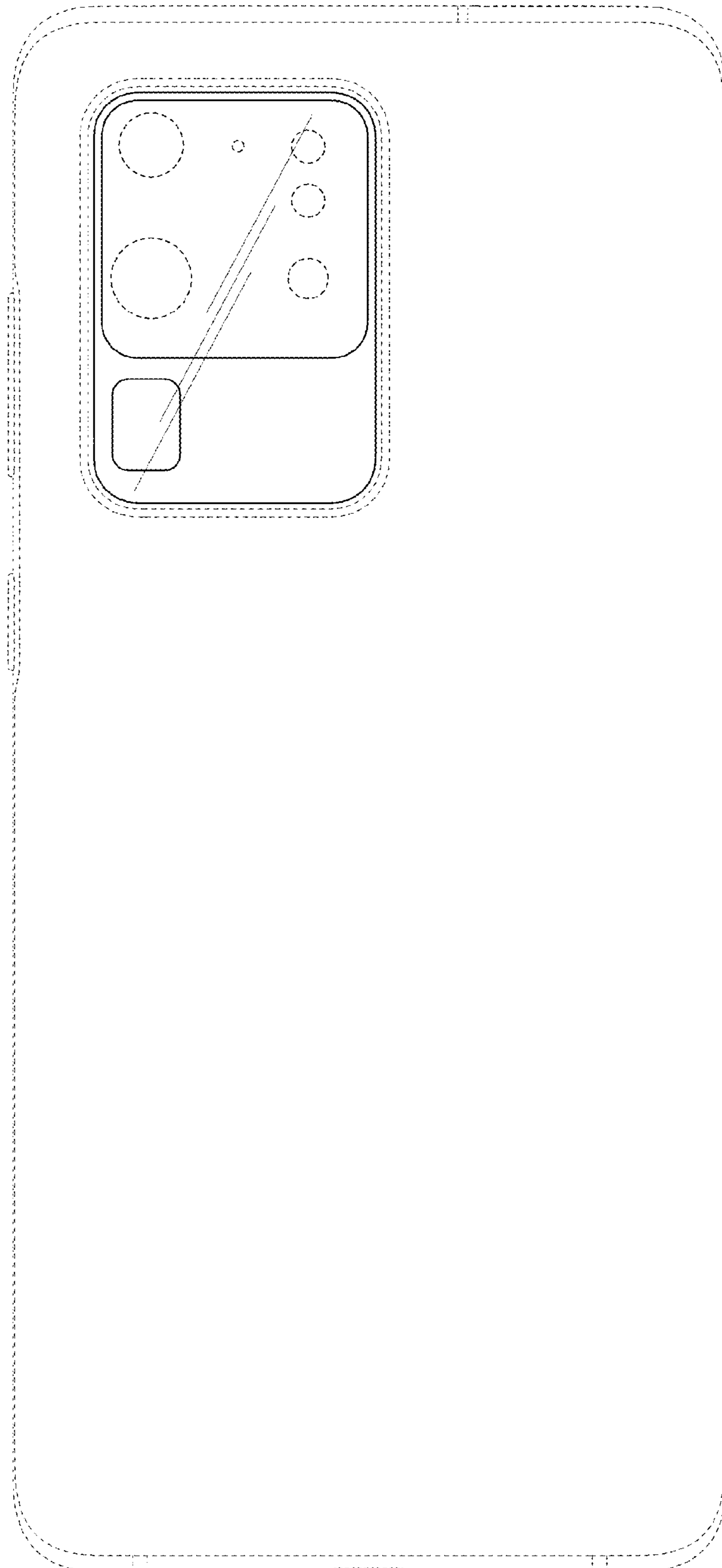

FIG. 12

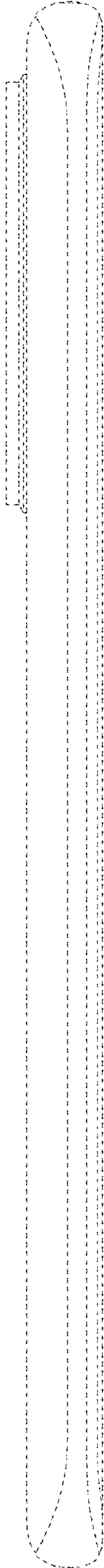

FIG. 13

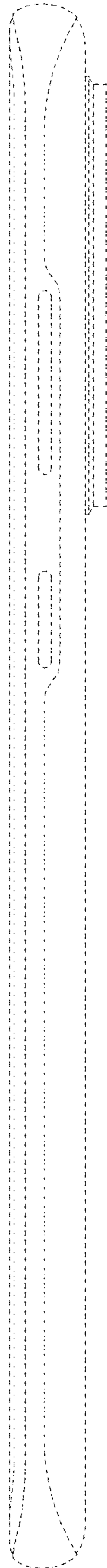

FIG. 14

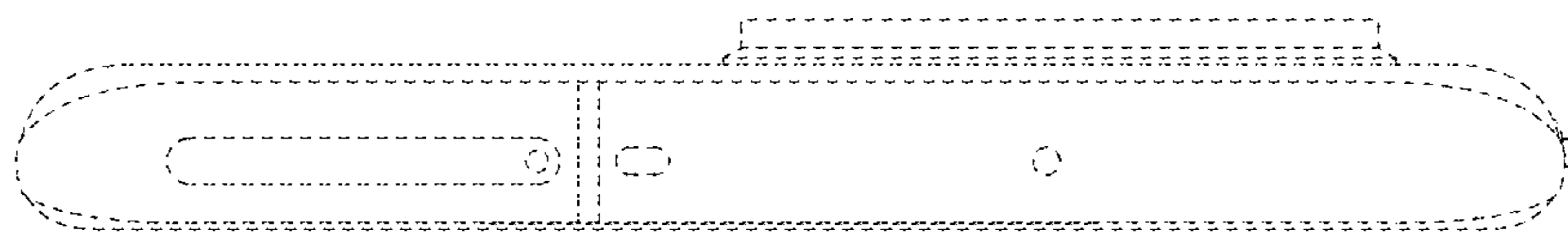



FIG. 15

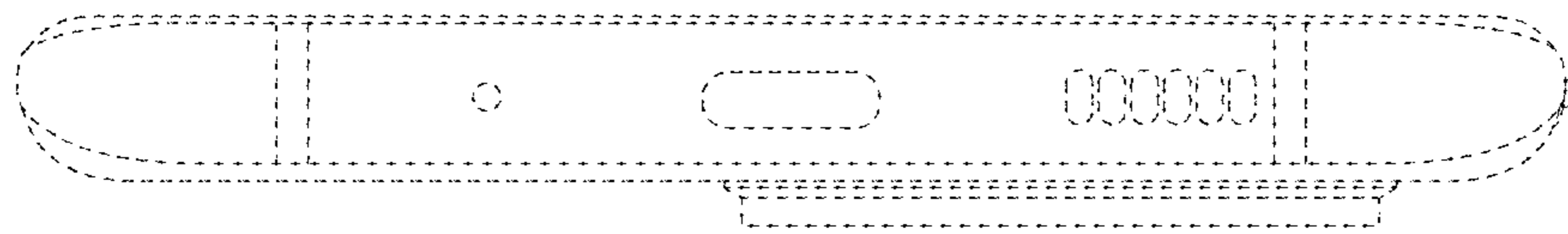

FIG. 16

