



US00D958725S

(12) **United States Design Patent**
Galderisi et al.

(10) **Patent No.:** **US D958,725 S**
(45) **Date of Patent:** **** Jul. 26, 2022**

(54) **TIRE**

DESCRIPTION

(71) Applicant: **Bridgestone Europe NV/SA**, Zaventem (BE)

(72) Inventors: **Alessandro Galderisi**, Rome (IT);
Emiliano Sabetti, Rome (IT)

(73) Assignee: **Bridgestone Europe NV/SA**, Zaventem (BE)

(**) Term: **15 Years**

(21) Appl. No.: **29/756,548**

(22) Filed: **Oct. 29, 2020**

(30) **Foreign Application Priority Data**

May 25, 2020 (EM) 007968276-0001

May 25, 2020 (EM) 007968276-0002

(51) **LOC (13) Cl.** **12-15**

(52) **U.S. Cl.**
USPC **D12/517**

(58) **Field of Classification Search**
USPC D12/500-532, 604

(Continued)

(56) **References Cited**

U.S. PATENT DOCUMENTS

D761,716 S * 7/2016 Albouy D12/519

D807,279 S * 1/2018 Hung D12/519

(Continued)

FOREIGN PATENT DOCUMENTS

EM 000936125-0001 6/2008

EM 001991373-0013 2/2012

(Continued)

Primary Examiner — John A Voytek

(57) **CLAIM**

The ornamental design for a tire, as shown and described.

FIG. 1 is a side perspective view of a first embodiment of a tire showing our new design, it being understood that the tread pattern is repeated throughout the circumference of the tire, the opposite side being the same as that shown;

FIG. 2 is a front elevational view of the first embodiment of the tire;

FIG. 3 is a side elevational view of the left side of the first embodiment of the tire;

FIG. 4 is a side elevational view of the right side of the first embodiment of the tire;

FIG. 5 is an enlarged fragmentary view of FIG. 2 with section lines related to views 6-6, 7-7, and 8-8;

FIG. 6 is a first transversal section view of the first embodiment of the tire taken along line 6-6;

FIG. 7 is a second transversal section view of the first embodiment of the tire taken along line 7-7;

FIG. 8 is a third transversal section view of the first embodiment of the tire taken along line 8-8;

FIG. 9 is a side perspective view of a second embodiment of a tire showing our new design, it being understood that the tread pattern is repeated throughout the circumference of the tire, the opposite side being the same as that shown;

FIG. 10 is a front elevational view of the second embodiment of the tire;

FIG. 11 is a side elevational view of the left side of the second embodiment of the tire;

FIG. 12 is a side elevational view of the right side of the second embodiment of the tire;

FIG. 13 is an enlarged fragmentary view of FIG. 10 with section lines related to views 14-14, 15-15, and 16-16;

FIG. 14 is a first transversal section view of the second embodiment of the tire taken along line 14-14;

FIG. 15 is a second transversal section view of the second embodiment of the tire taken along line 15-15; and,

FIG. 16 is a third transversal section view of the second embodiment of the tire taken along line 16-16.

The broken lines defining the sidewall and inner bead depict environmental subject matter that forms no part of the claimed design.

1 Claim, 16 Drawing Sheets

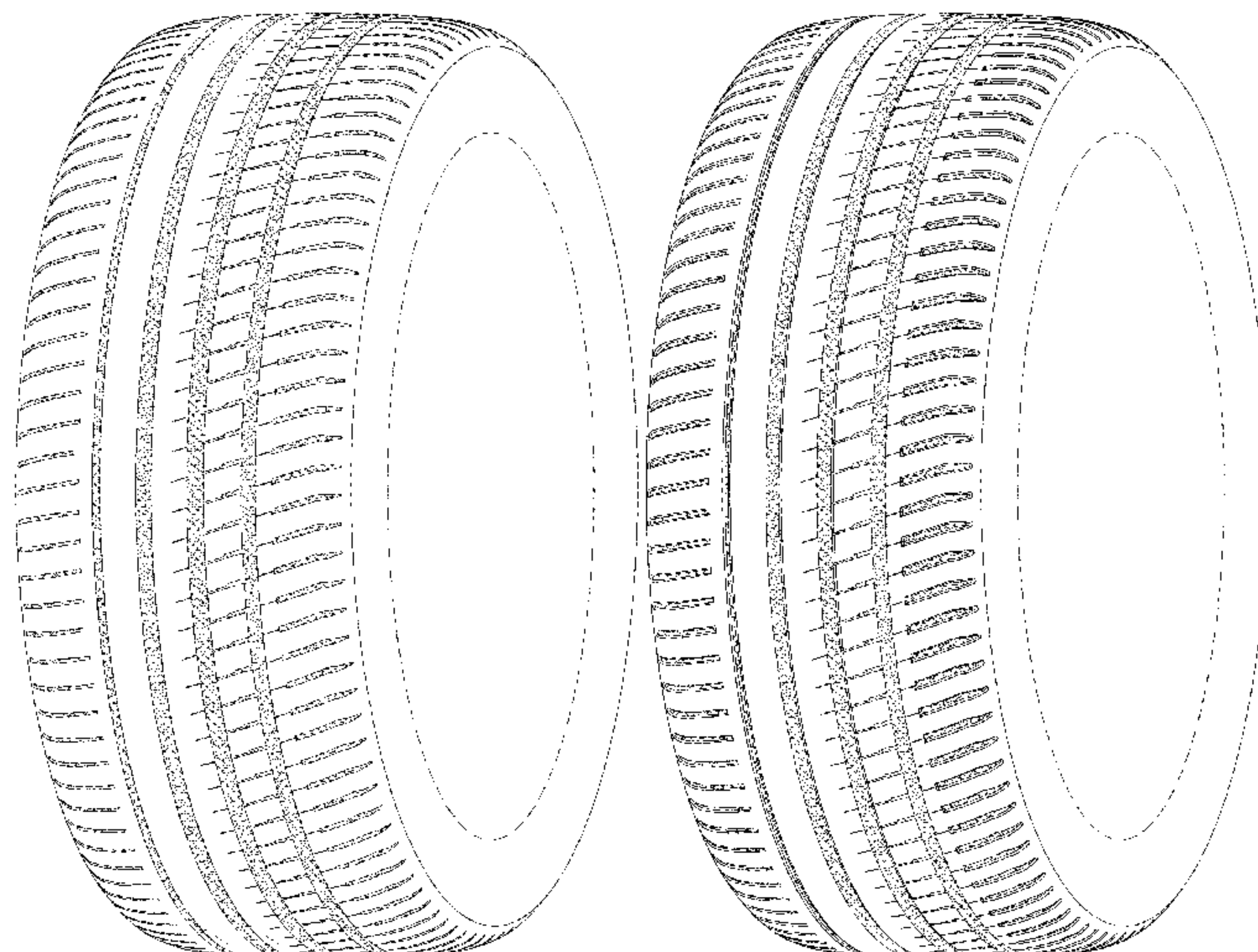

(58) **Field of Classification Search**

CPC Y10T 152/10027; B60C 1/0016; B60C
11/0306; B60C 11/0302; B60C 3/06;
B60C 9/17

See application file for complete search history.

(56) **References Cited**

U.S. PATENT DOCUMENTS

D823,232	S	*	7/2018	Bode	D12/515
D828,280	S	*	9/2018	Tae Min	D12/519
D872,684	S	*	1/2020	Kawagoe	D12/519
D887,342	S	*	6/2020	Moia	D12/521
D887,343	S	*	6/2020	Hoshiba	D12/523
D901,372	S	*	11/2020	Moia	D12/900
D904,280	S	*	12/2020	Kuwahara	D12/523
D918,126	S	*	5/2021	Matturo	D12/517
D920,223	S	*	5/2021	Uemura	D12/523
D935,382	S	*	11/2021	Matsumoto	D12/523

FOREIGN PATENT DOCUMENTS

EM	002345629-0001	12/2013
GB	2089071	3/2000

* cited by examiner

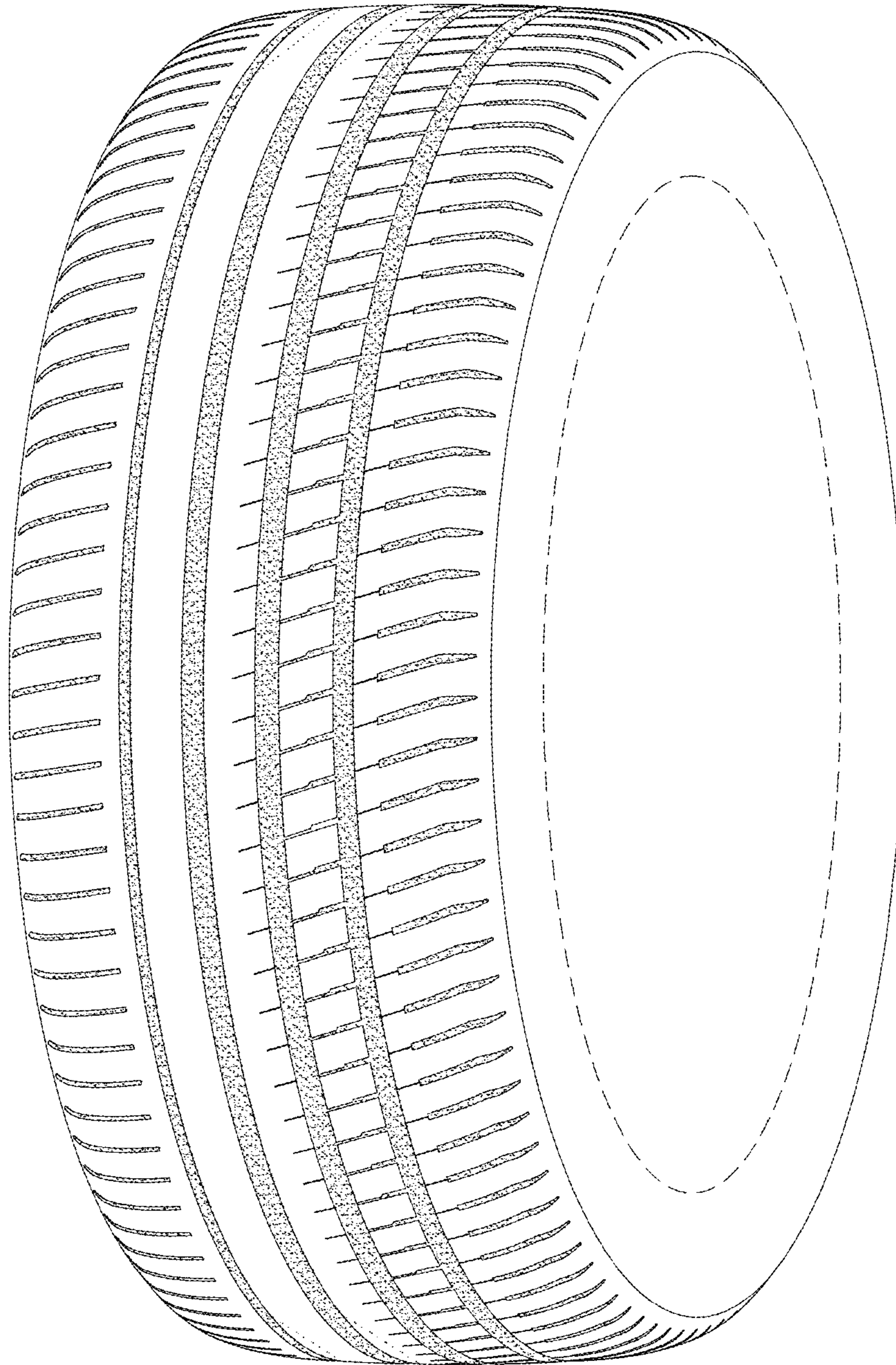

FIG.1

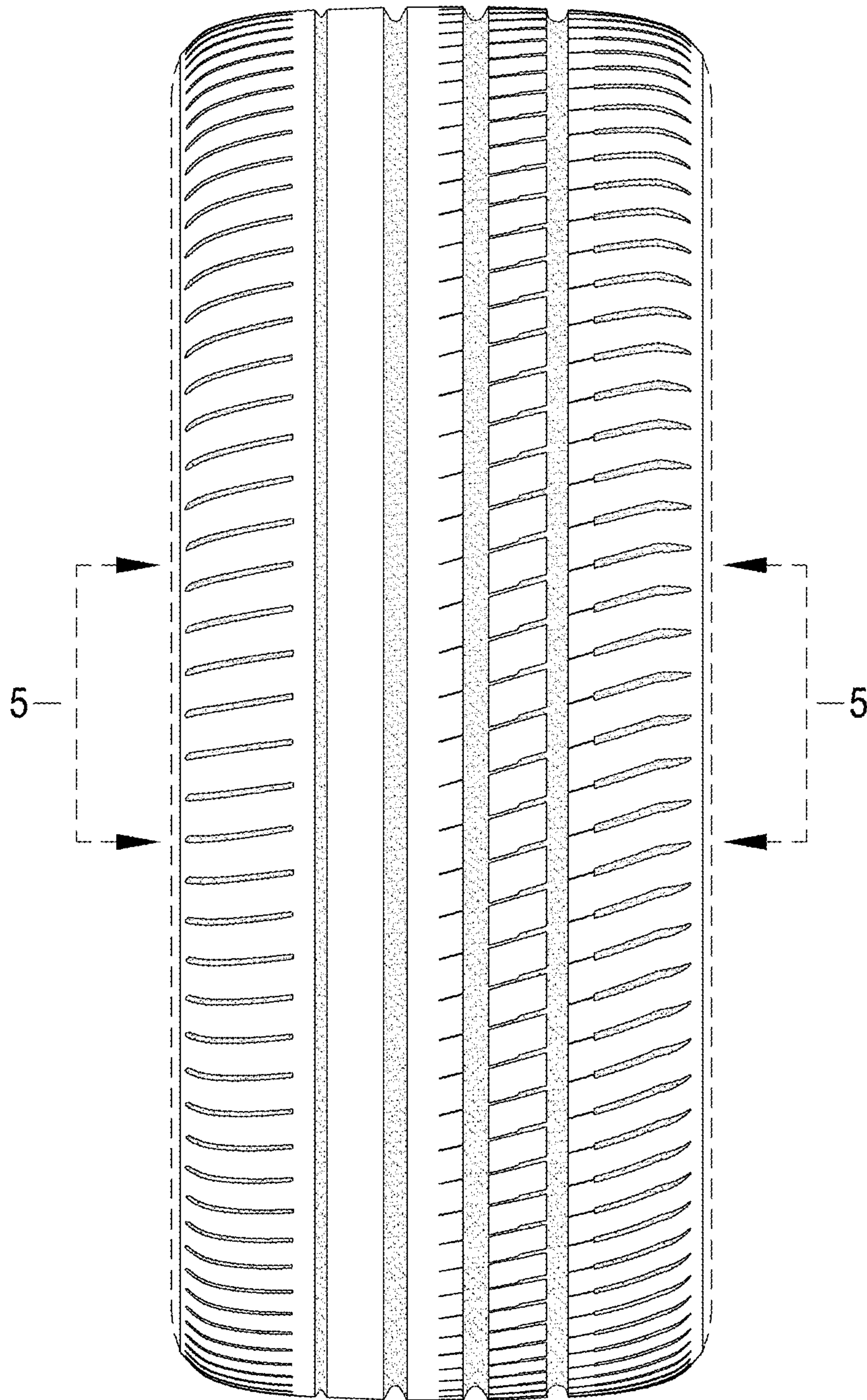

FIG.2

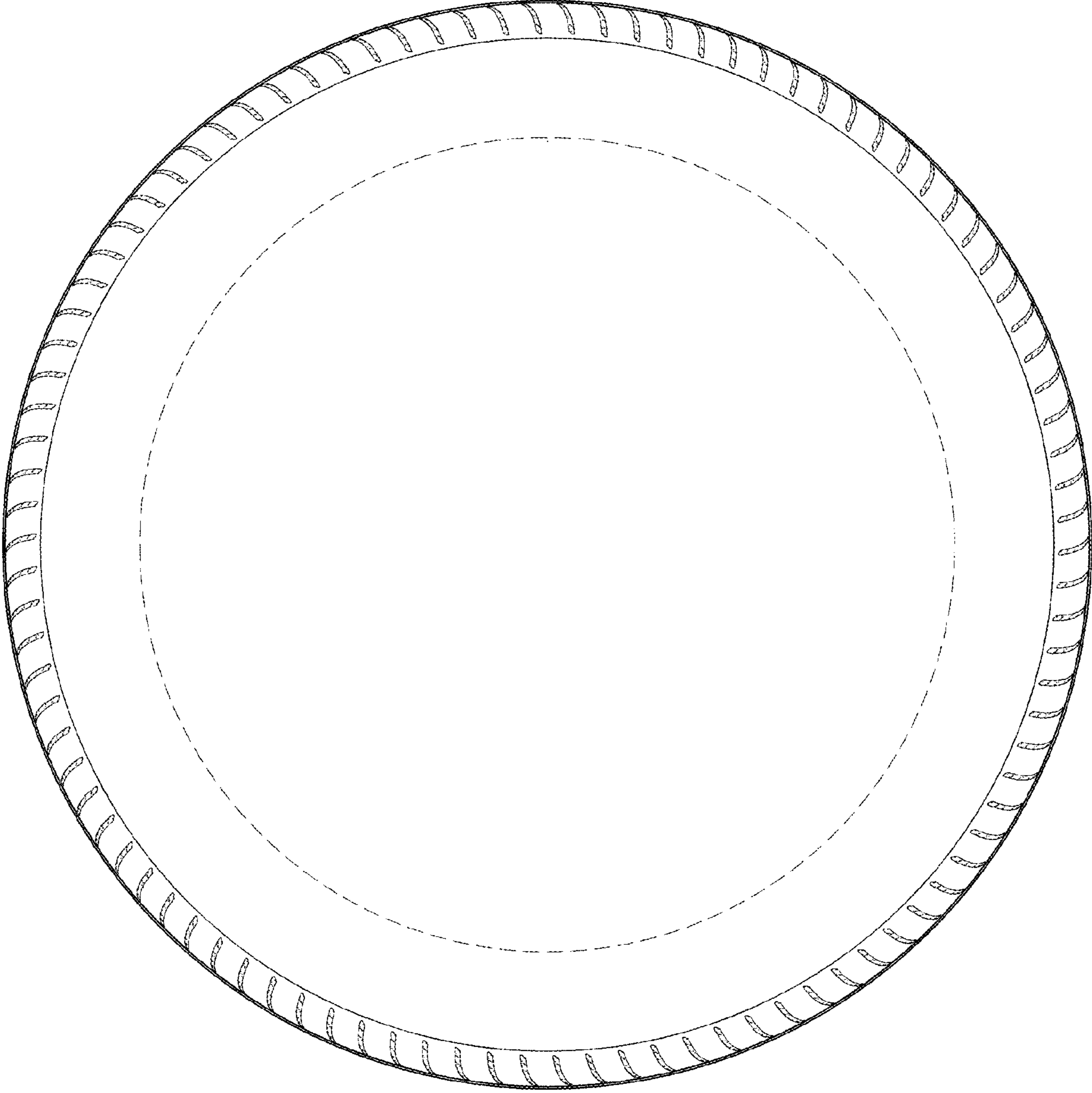

FIG.3

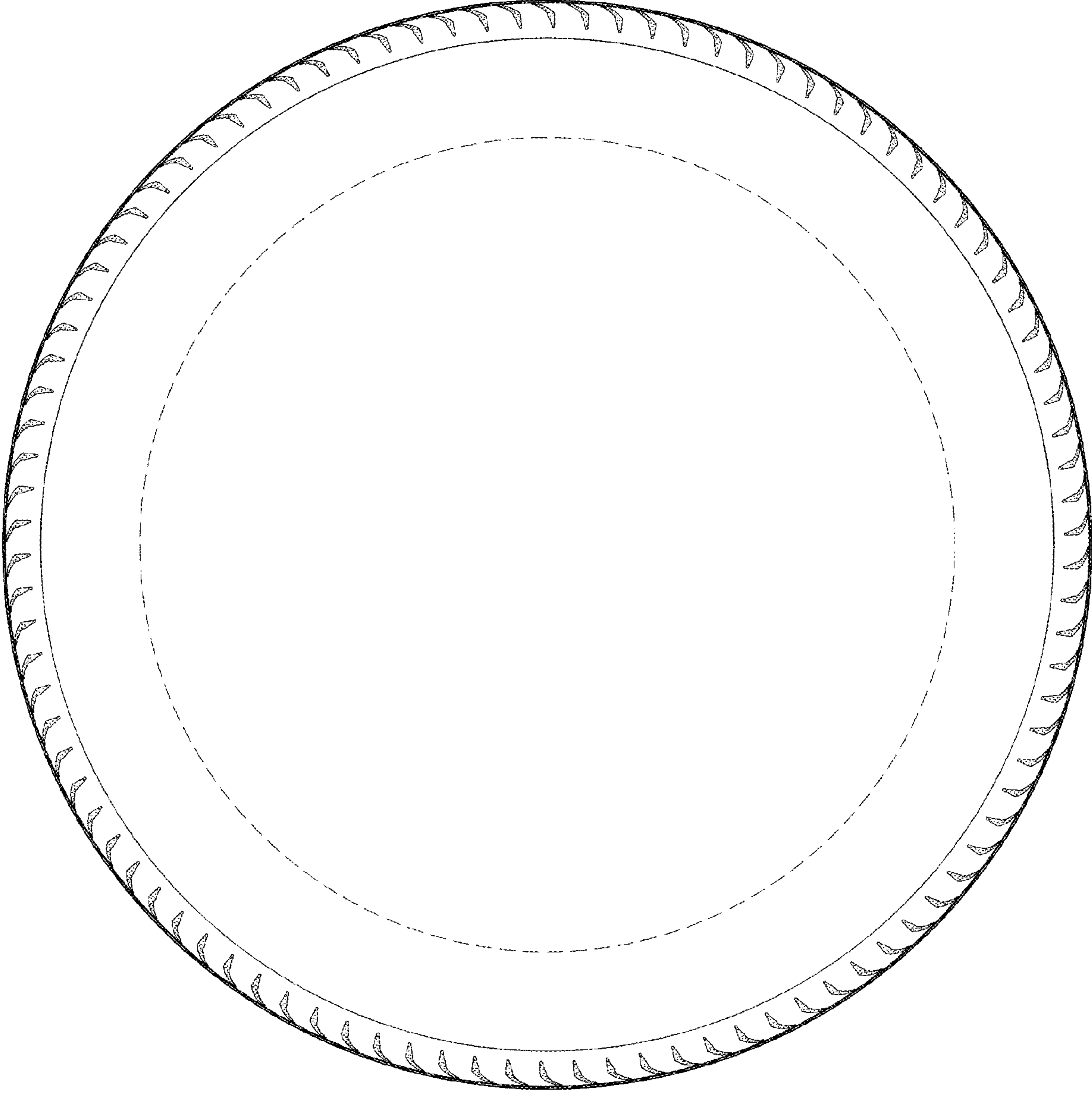

FIG.4

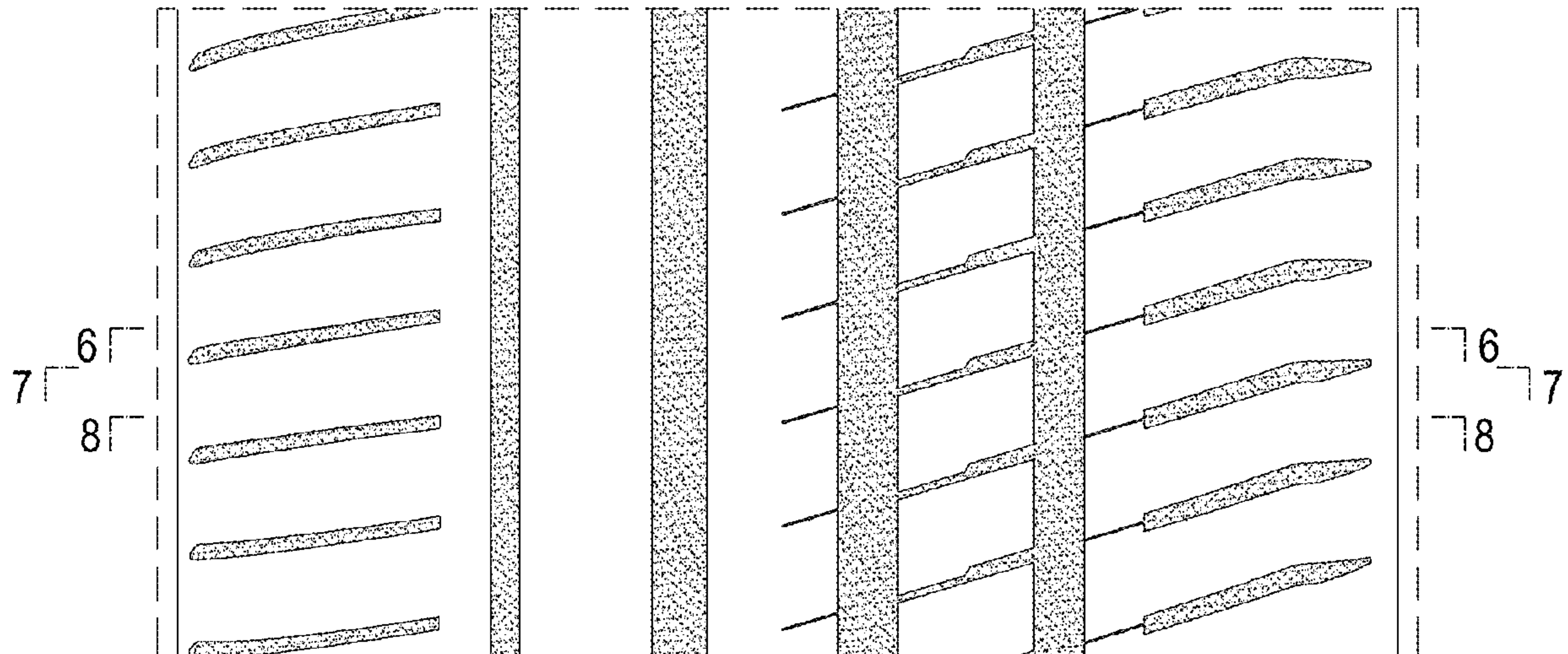

FIG.5

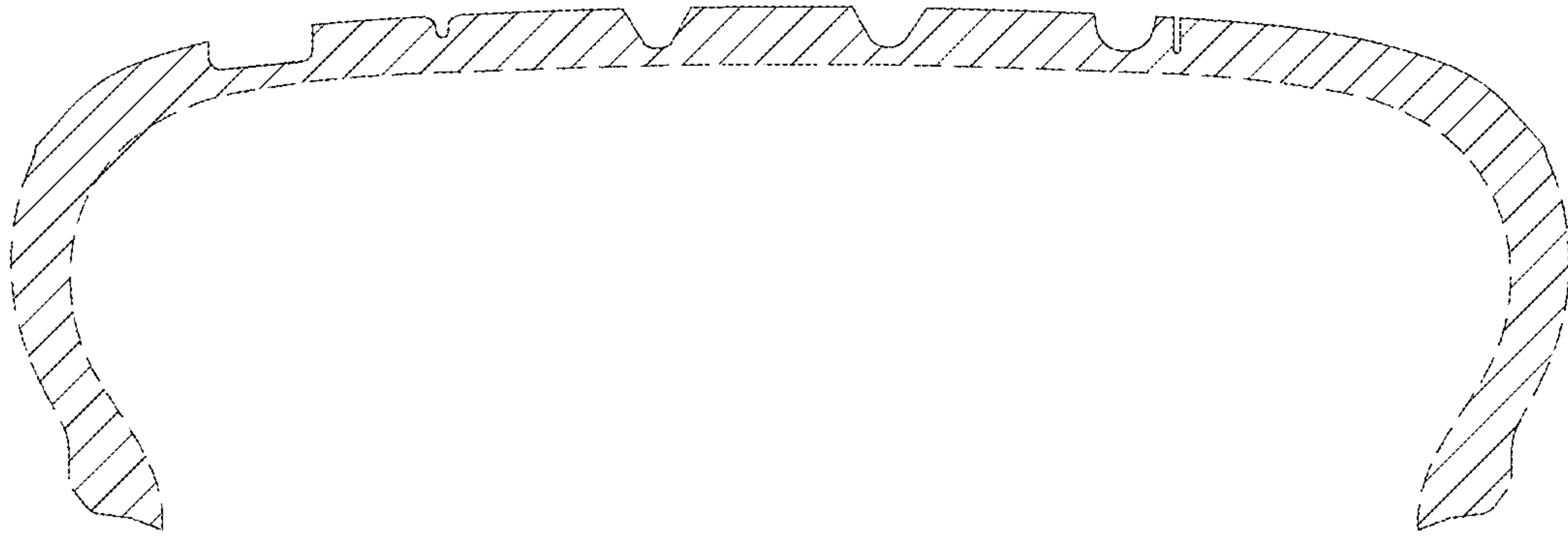

FIG.6

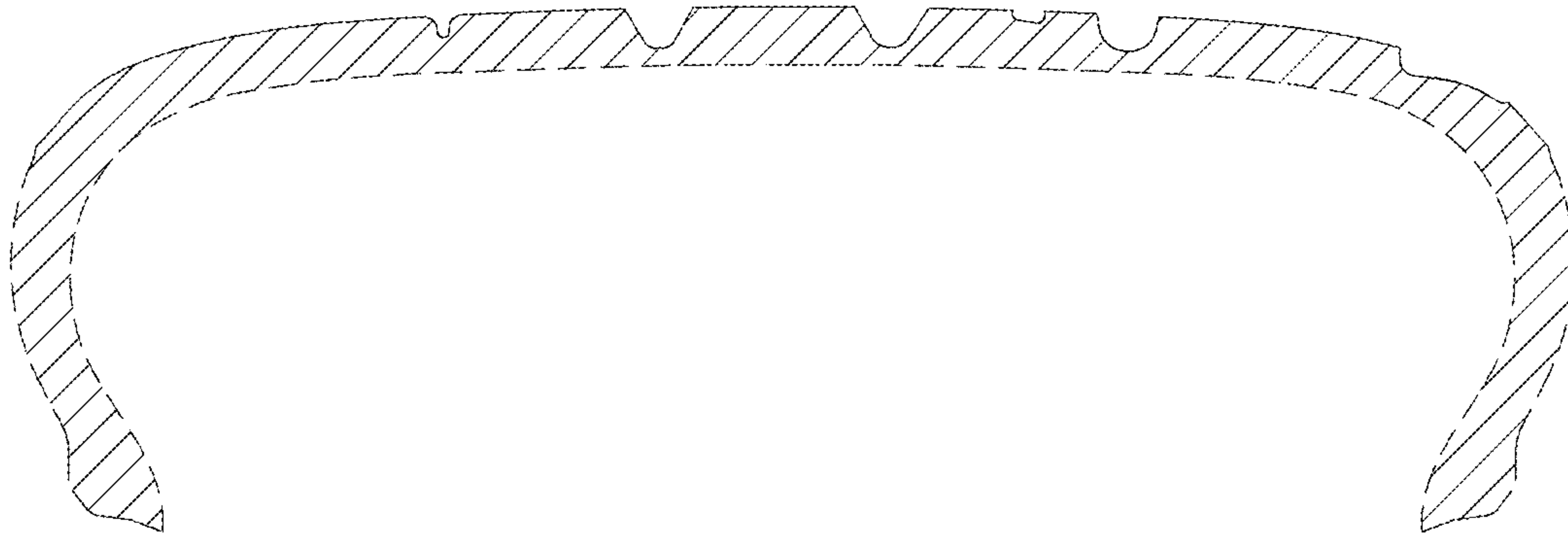

FIG.7

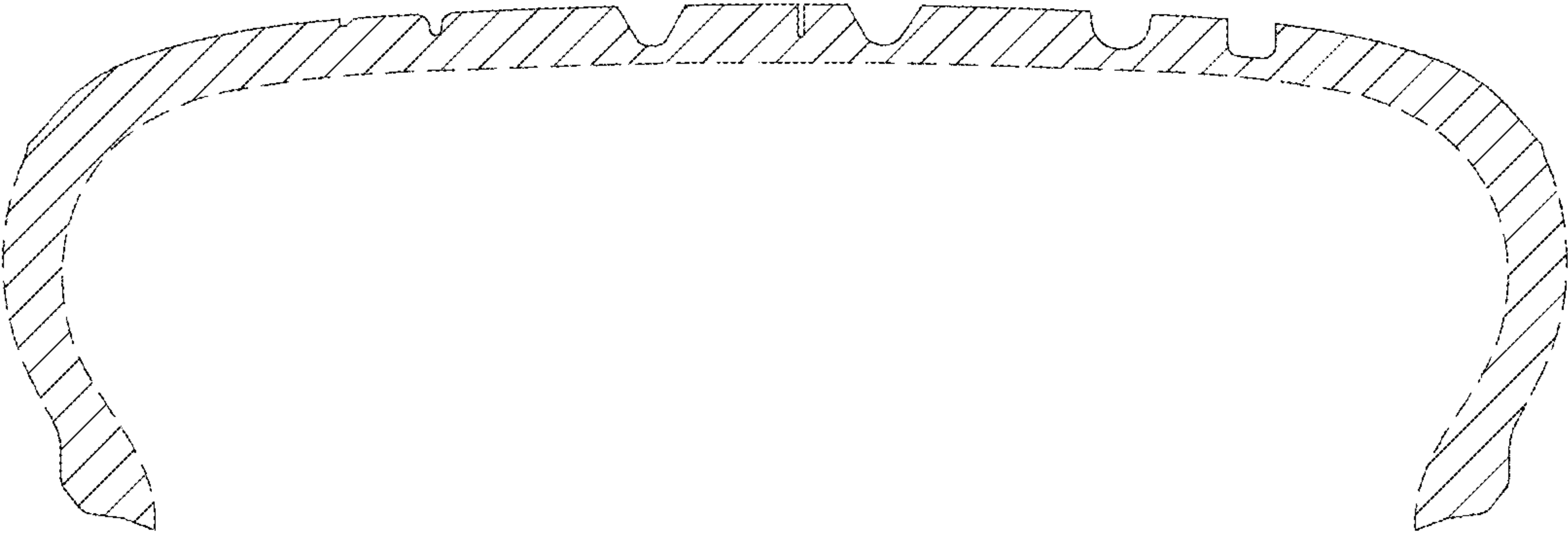

FIG.8

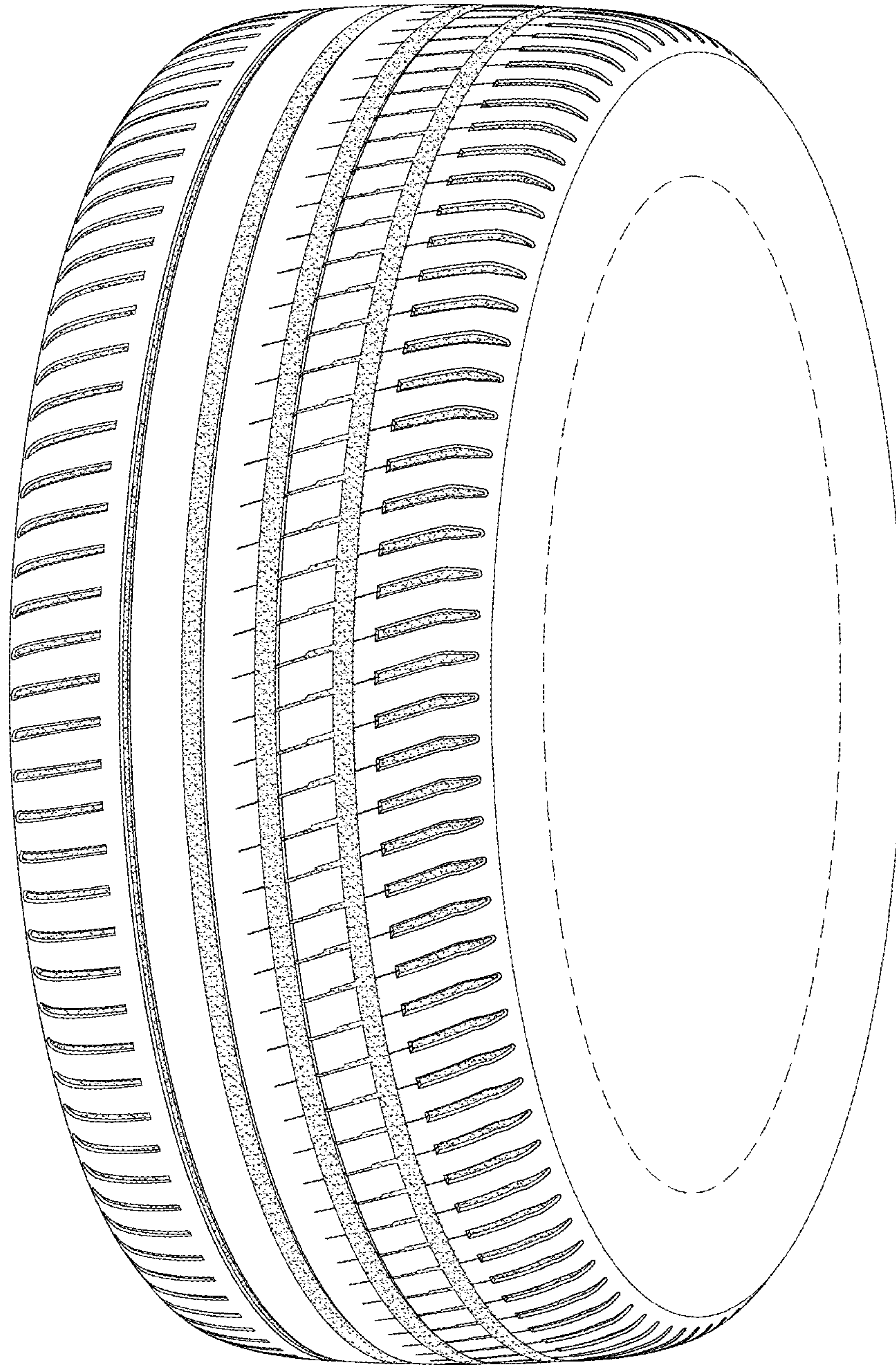

FIG.9

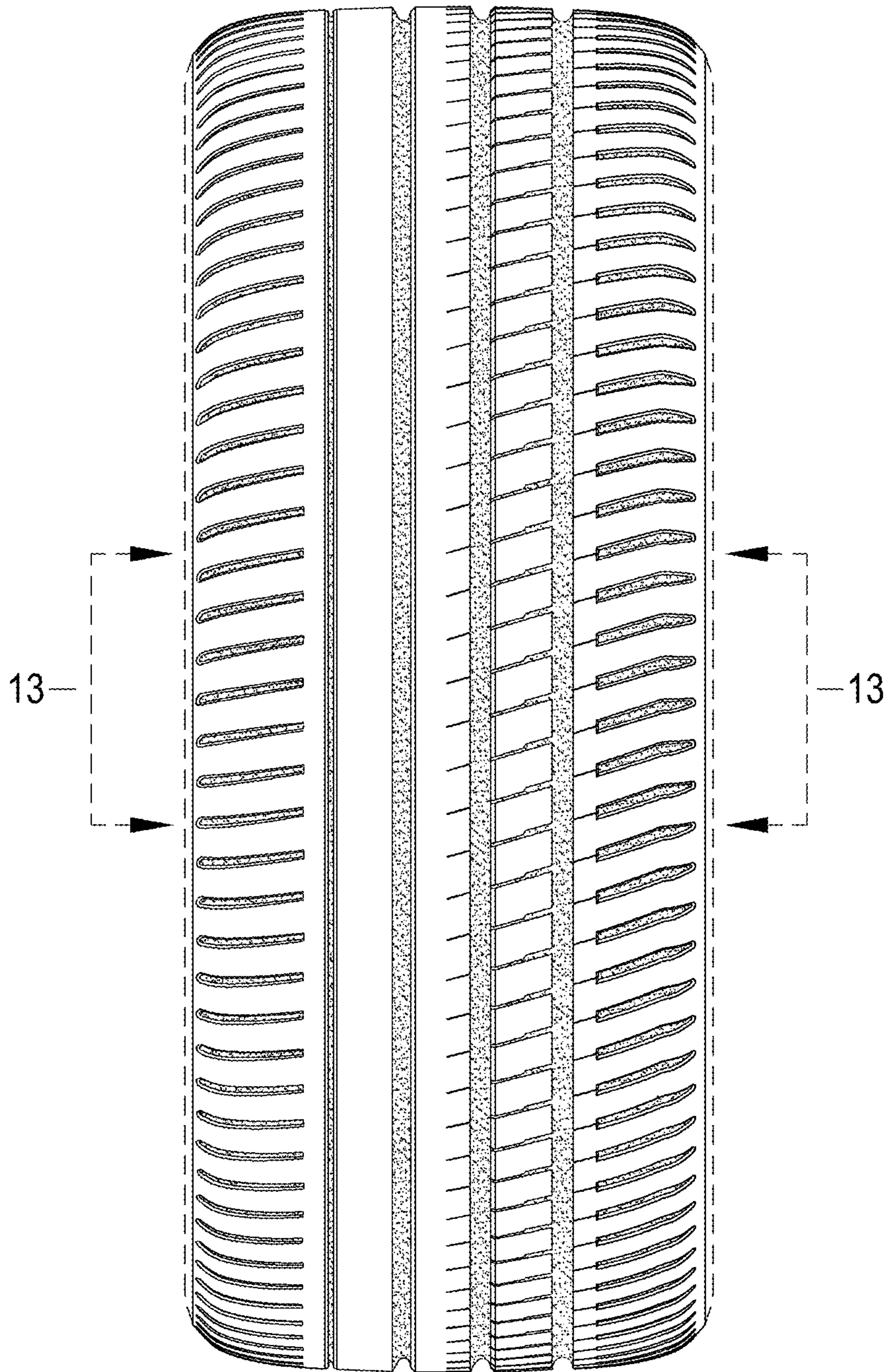

FIG.10

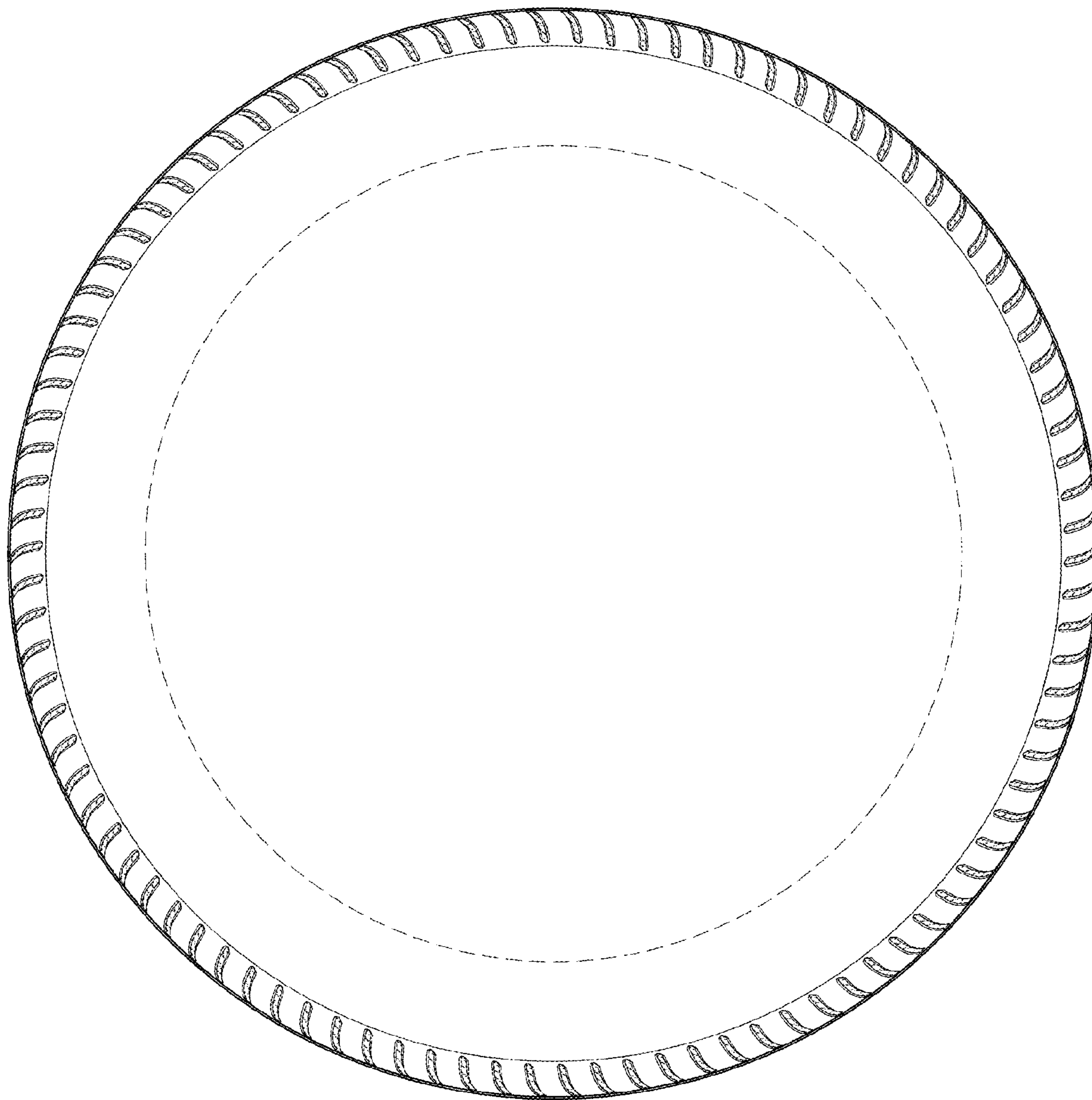

FIG.11

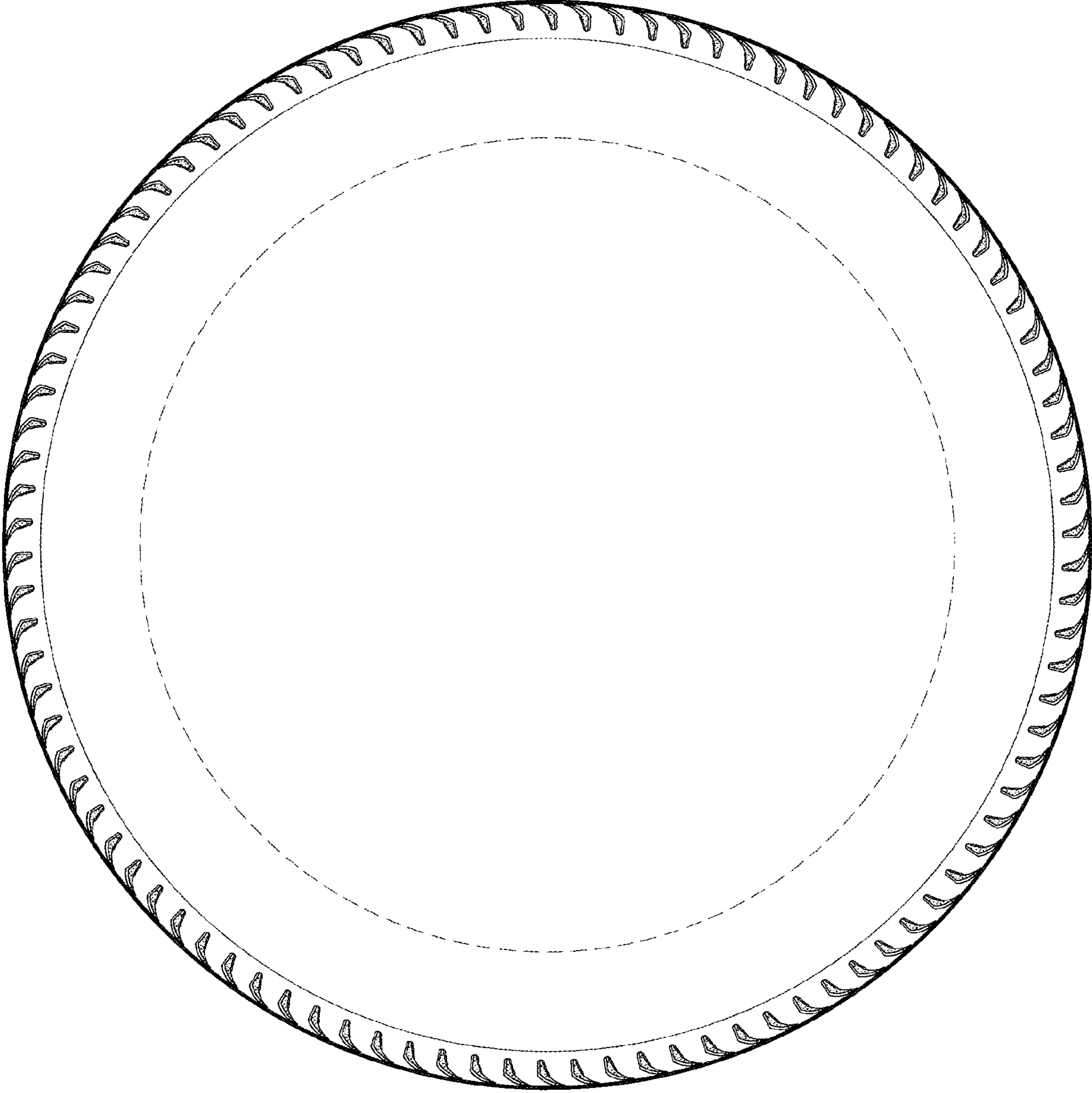

FIG.12

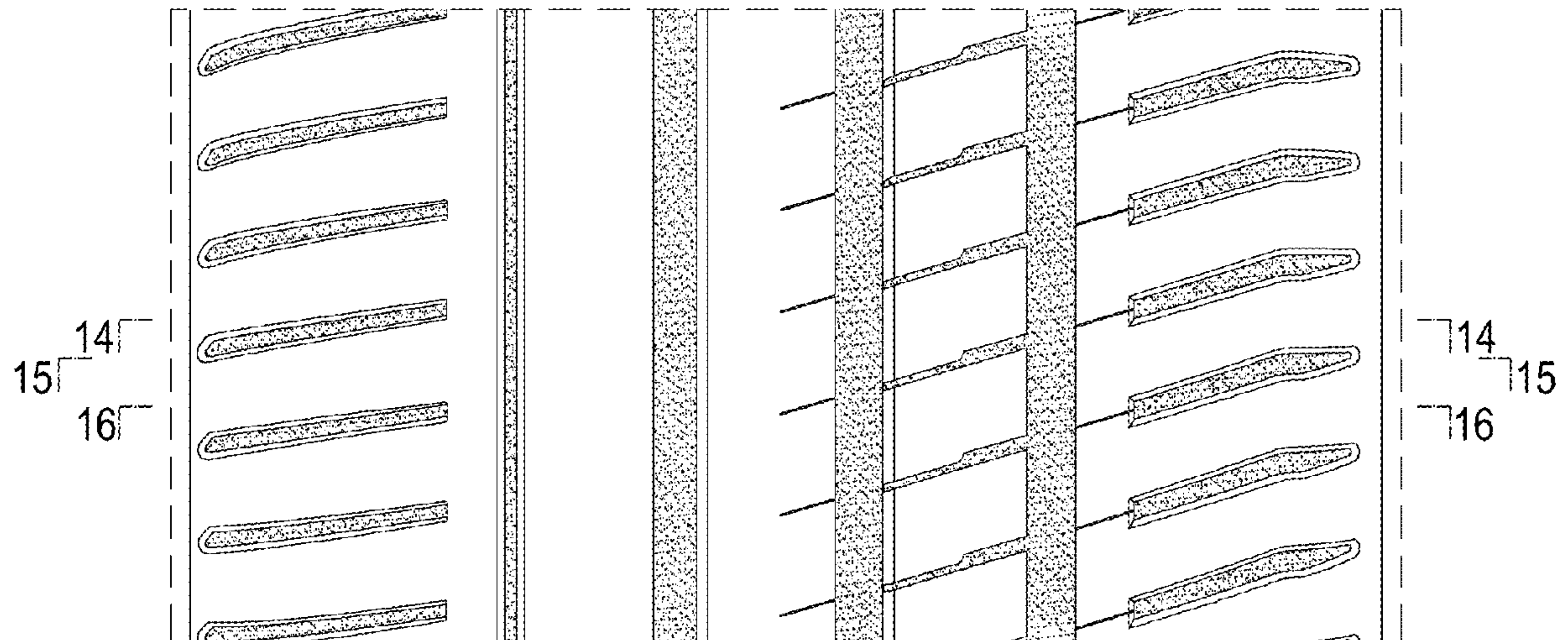

FIG.13

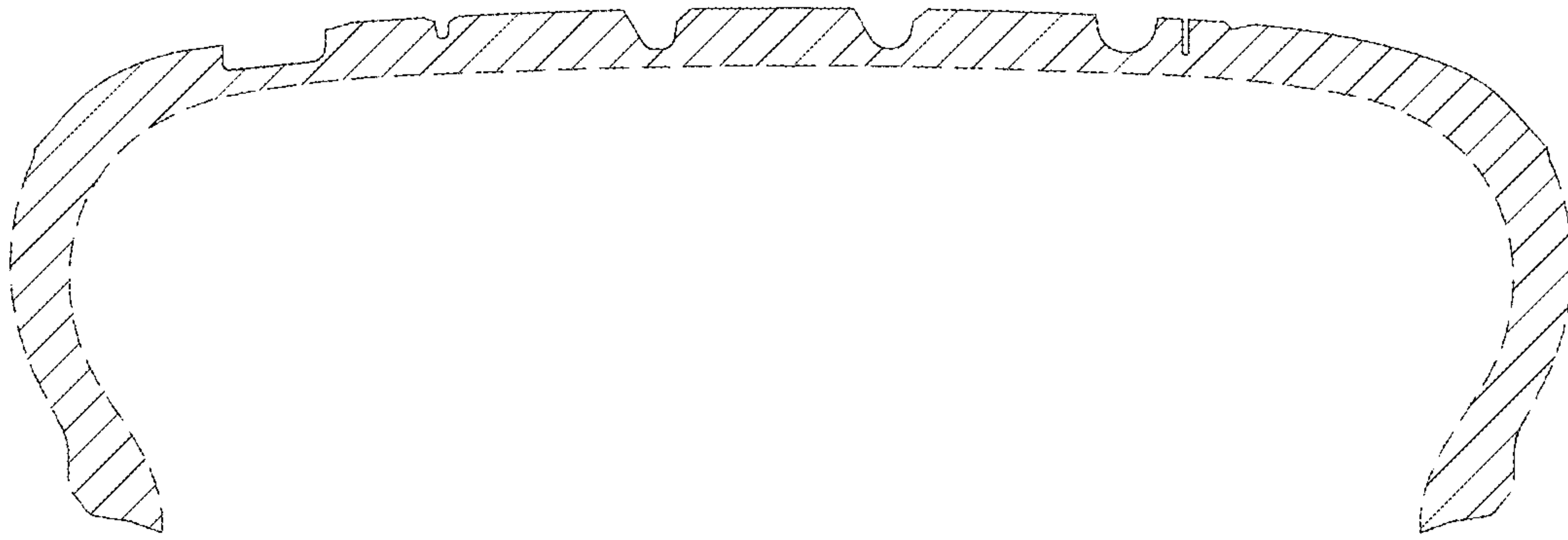

FIG.14

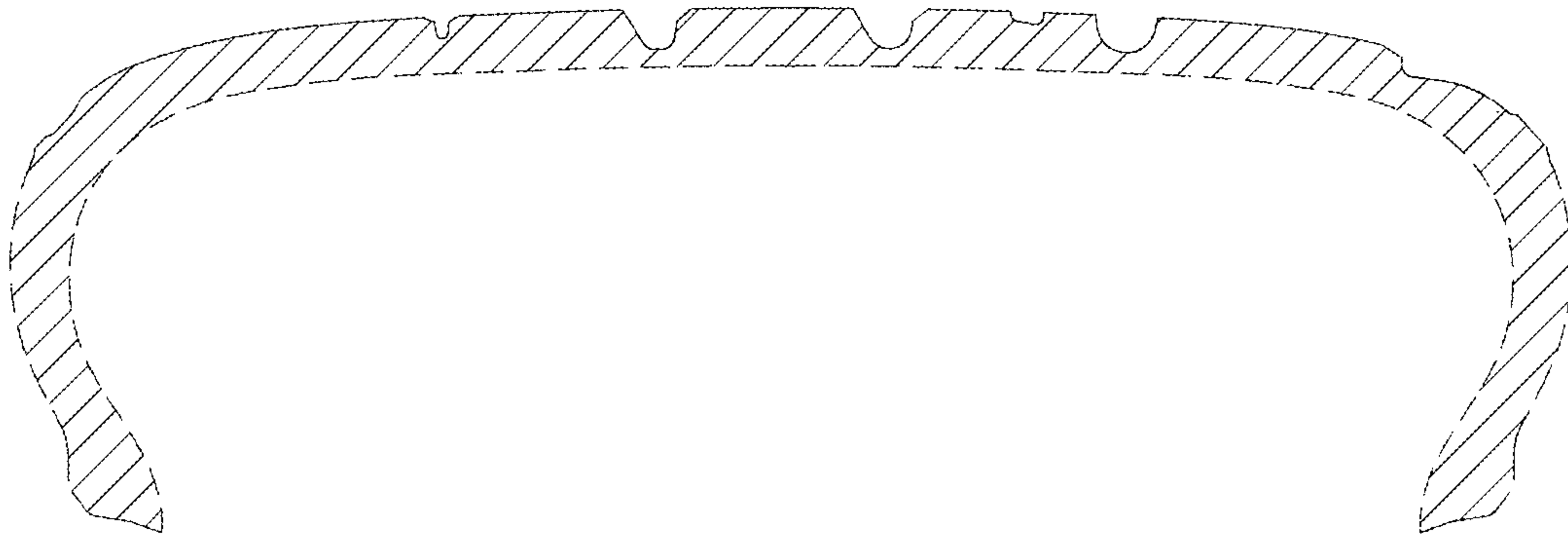

FIG.15

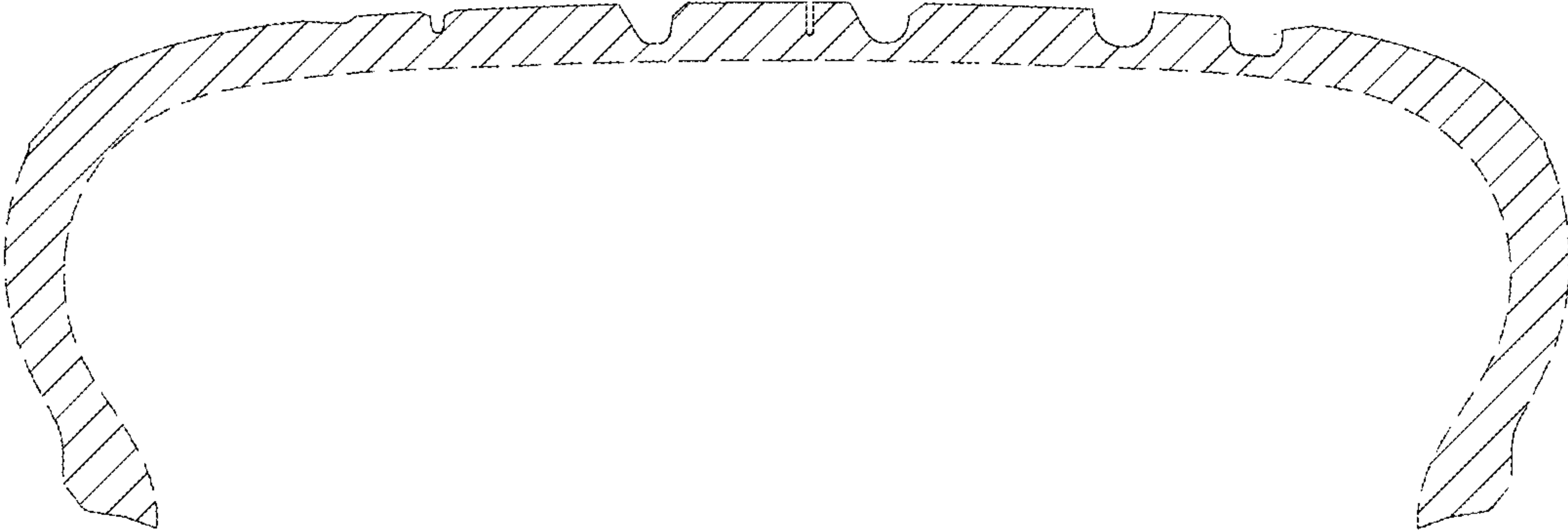

FIG.16