



US00D958647S

(12) **United States Design Patent**
Dwork

(10) **Patent No.:** **US D958,647 S**
(45) **Date of Patent:** **** Jul. 26, 2022**

(54) **FOOD CONTAINER**

(71) Applicant: **Michael D. Dwork**, New York, NY
(US)

(72) Inventor: **Michael D. Dwork**, New York, NY
(US)

(**) Term: **15 Years**

(21) Appl. No.: **29/744,807**

(22) Filed: **Jul. 31, 2020**

Related U.S. Application Data

(62) Division of application No. 29/622,057, filed on Oct. 13, 2017, now Pat. No. Des. 894,728.

(51) **LOC (13) Cl.** **09-03**

(52) **U.S. Cl.**
USPC **D9/420**

(58) **Field of Classification Search**
USPC D9/420, 431-433, 418, 456, 606;
D7/368; D3/295, 299; D27/187
(Continued)

(56) **References Cited**

U.S. PATENT DOCUMENTS

3,837,560 A * 9/1974 Kuchuris B26D 3/006
229/120.36
4,187,975 A * 2/1980 Shepherd B65D 5/48038
217/31

(Continued)

OTHER PUBLICATIONS

VerTerra Collapsible Box with Attached Lid—Medium Square (10), Amazon.com, Jul. 31, 2015, https://www.amazon.com/VerTerra-Collapsible-Box-Attached-Lid/dp/B0133YCIH2/ref=sr_1_6?ie=UTF8&qid=1508969356&sr=8-6&keywords=verterra.

(Continued)

Primary Examiner — Rhea Shields

(74) *Attorney, Agent, or Firm* — Merchant & Gould P.C.

(57) **CLAIM**

The ornamental design for a food container, as shown and described.

DESCRIPTION

FIG. 1 is an isometric view of a food container according to a first embodiment of the present disclosure in a first folded position;

FIG. 2 is an isometric view of the food container of FIG. 1 in a second folded position;

FIG. 3 is an isometric view of the food container of FIG. 1 in a first upright position;

FIG. 4 is an isometric view of the food container of FIG. 1 in a second upright position;

FIG. 5 is a right side view of the food container of FIG. 1 in the second upright position;

FIG. 6 is a left side view of the food container of FIG. 1 in the second upright position;

FIG. 7 is a front view of the food container of FIG. 1 in the second upright position;

FIG. 8 is a rear view of the food container of FIG. 1 in the second upright position;

FIG. 9 is an isometric view of the food container of FIG. 1 with the lid of the food container in a closed position;

FIG. 10 is a bottom view of the food container of FIG. 1 with the lid of the food container in the closed position;

FIG. 11 is an isometric view of FIG. 1, shown in an environment;

FIG. 12 is an isometric view of FIG. 1, shown in an environment;

FIG. 13 is an isometric view of FIG. 1, shown in an environment; and,

FIG. 14 is an isometric view of FIG. 1, shown in an environment.

The broken lines in the Figures depict portions of the food container that form no part of the claimed design.

1 Claim, 14 Drawing Sheets

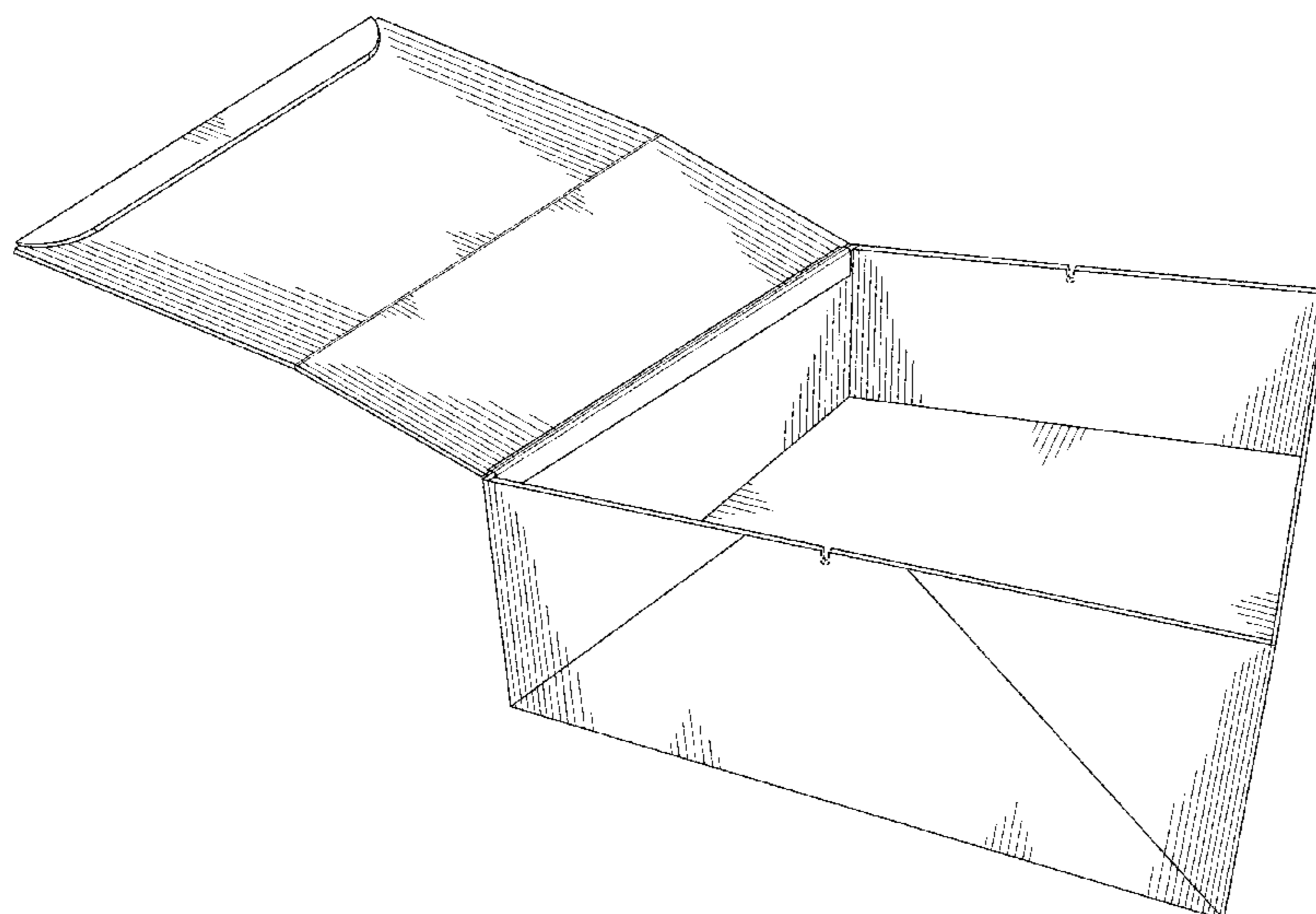

(58) **Field of Classification Search**
 CPC B65D 25/06; B65D 5/48038; B65D 5/321;
 B26D 3/006
 See application file for complete search history.

D903,488 S * 12/2020 Perella D9/432
 D903,494 S * 12/2020 Dwork D9/456
 2006/0243785 A1* 11/2006 Wang B65D 5/321
 229/122
 2019/0112094 A1* 4/2019 Dwork B65D 25/06

(56) **References Cited**

U.S. PATENT DOCUMENTS

5,271,552	A	12/1993	McDonnell	
5,456,352	A	10/1995	McQueeny	
D439,157	S	3/2001	Tsuruishi et al.	
D474,688	S *	5/2003	Litts	D3/295
D568,766	S	5/2008	Miles	
D690,554	S	10/2013	Presley	
9,096,349	B2	8/2015	Youell et al.	
D737,688	S	9/2015	Stone	
D762,113	S	7/2016	Mayer et al.	
D764,280	S *	8/2016	Carnu	D9/431
D800,548	S	10/2017	Sill et al.	
D815,343	S *	4/2018	Kesselman	D27/187
D823,692	S	7/2018	Greenberg et al.	
D850,908	S *	6/2019	Perella	D9/432
D855,457	S	8/2019	D'Agnone	
D858,274	S *	9/2019	Perella	D9/432
D860,778	S *	9/2019	Dwork	D9/418
D874,267	S *	2/2020	Perella	D9/432
D883,670	S *	5/2020	Perella	D3/299
D887,265	S *	6/2020	Perella	D9/432
D894,728	S *	9/2020	Dwork	D9/420
D902,719	S *	11/2020	Dwork	D9/456

OTHER PUBLICATIONS

VerTerra Collapsible Box With Attached Lid—Large Rectangle (100), Amazon.com, Aug. 10, 2015, https://www.amazon.com/VerTerra-Collapsible-Box-Attached-Lid/dp/B013PTVIGC/ref=sr_1_11?ie=UTF8&qid=1508969356&sr=8-11&keywords=verterra.
 VerTerra Large Collapsible Tray 3" Deep (10), Amazon.com, Jul. 30, 2015, https://www.amazon.com/VerTerra-Large-Collapsible-Tray-Deep/dp/B0131D4TGI/ref=sr_1_28?ie=UTF8&qid=1508969534&sr=8-28&keywords=verterra.
 VerTerra Collapsible Box with Attached Lid—Small Square (10), Amazon.com, Jul. 31, 2015, https://www.amazon.com/VerTerra-Collapsible-Box-Attached-Lid/dp/B0133WMUP4/ref=sr_1_55?ie=UTF8&qid=1508969706&sr=8-55&keywords=verterra.
 VerTerra Collapsible Small Tray 6x6" (50), Amazon.com, Jul. 29, 2015, https://www.amazon.com/VerTerra-Collapsible-Small-Tray-6x6/dp/B012XYB1DK/ref=sr_1_43?ie=UTF8&qid=1516116567&sr=8-43&keywords=verterra.
 VerTerra Collapsible Tray with Attached Lid—Large Tray 2" Deep (100), Amazon.com, Aug. 3, 2015, <https://www.amazon.com/VerTerra-Collapsible-Tray-Attached-Lid/dp/B013CHP412>.

* cited by examiner

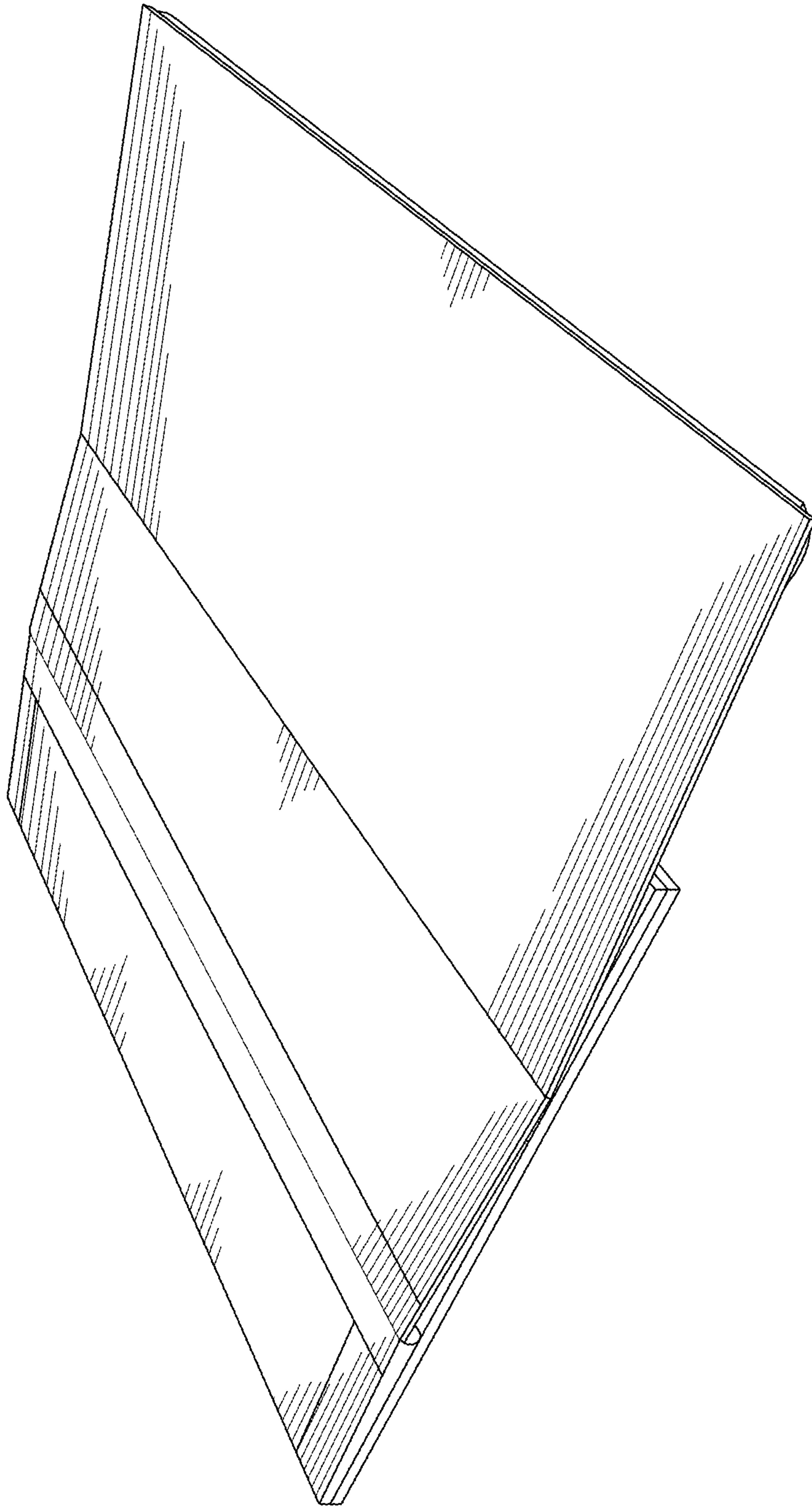

FIG. 1

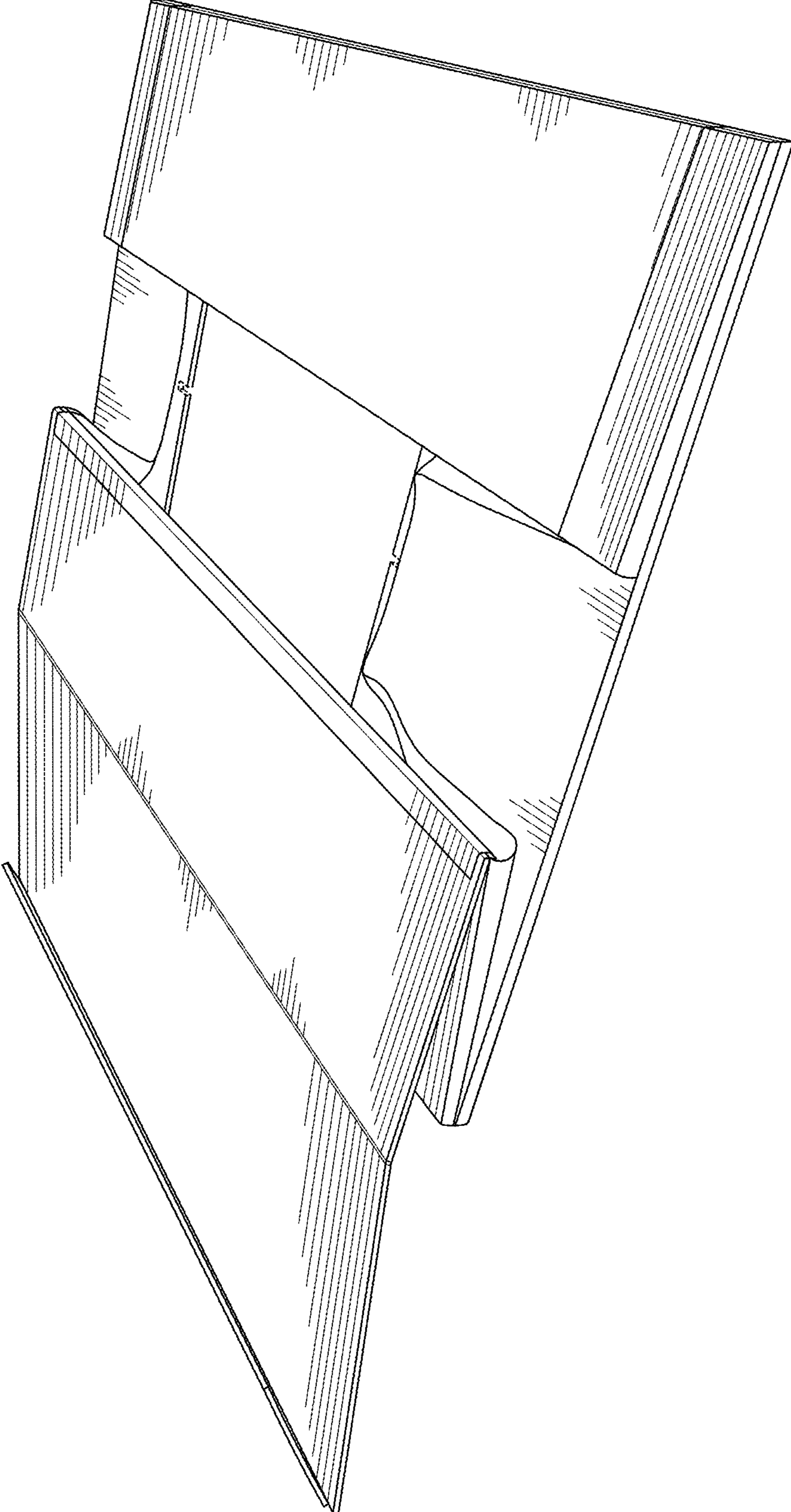

FIG. 2

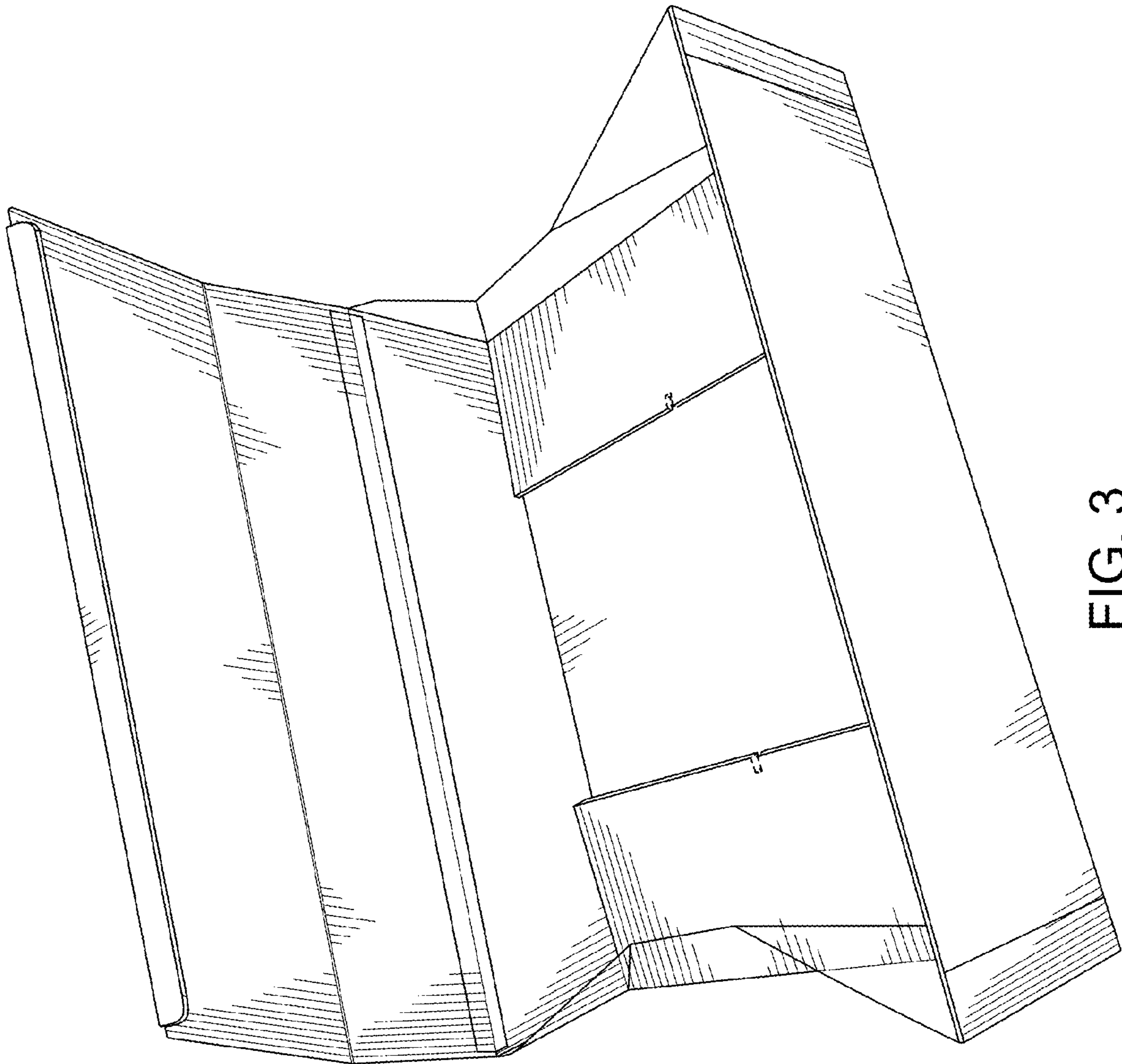

FIG. 3

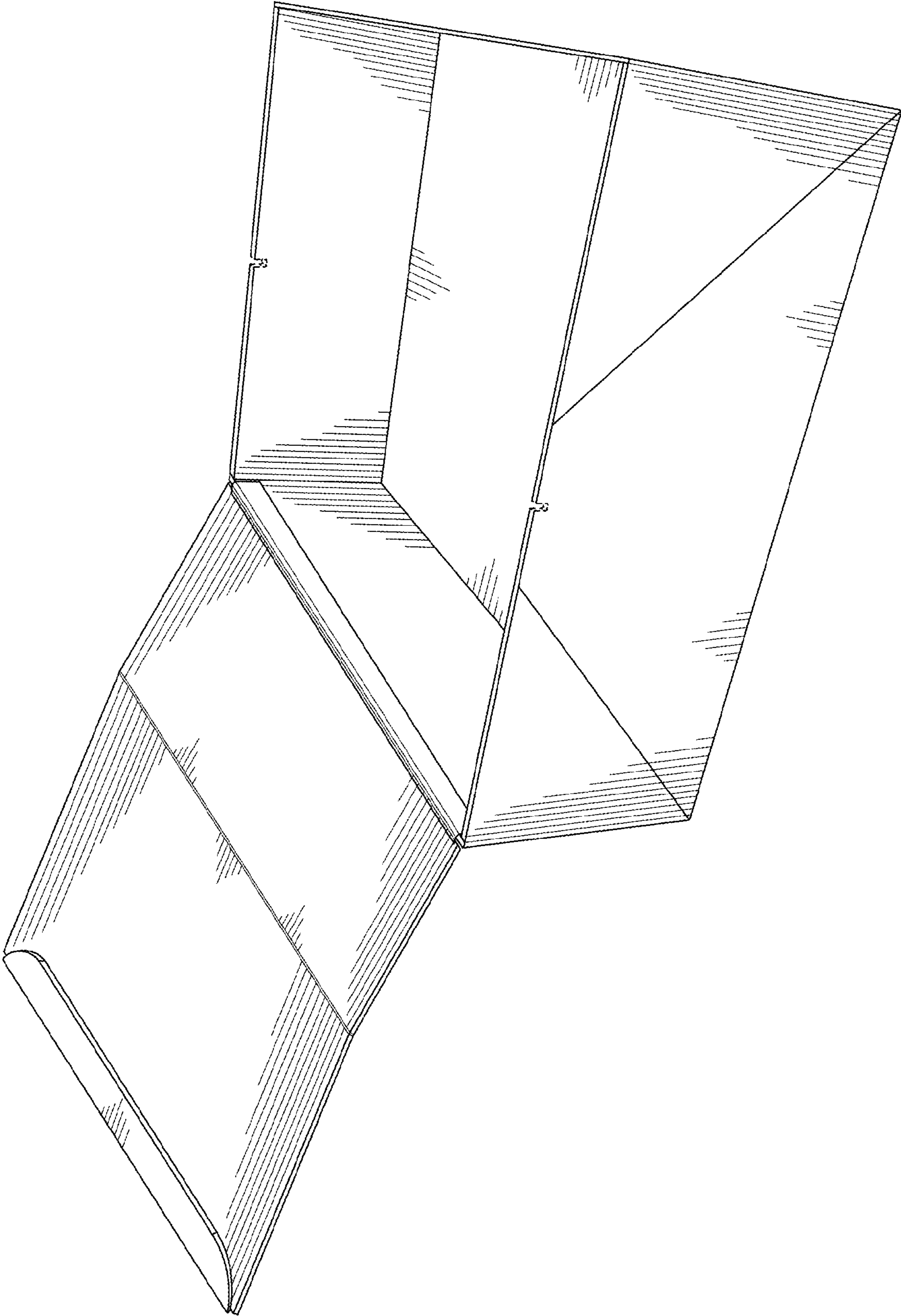

FIG. 4

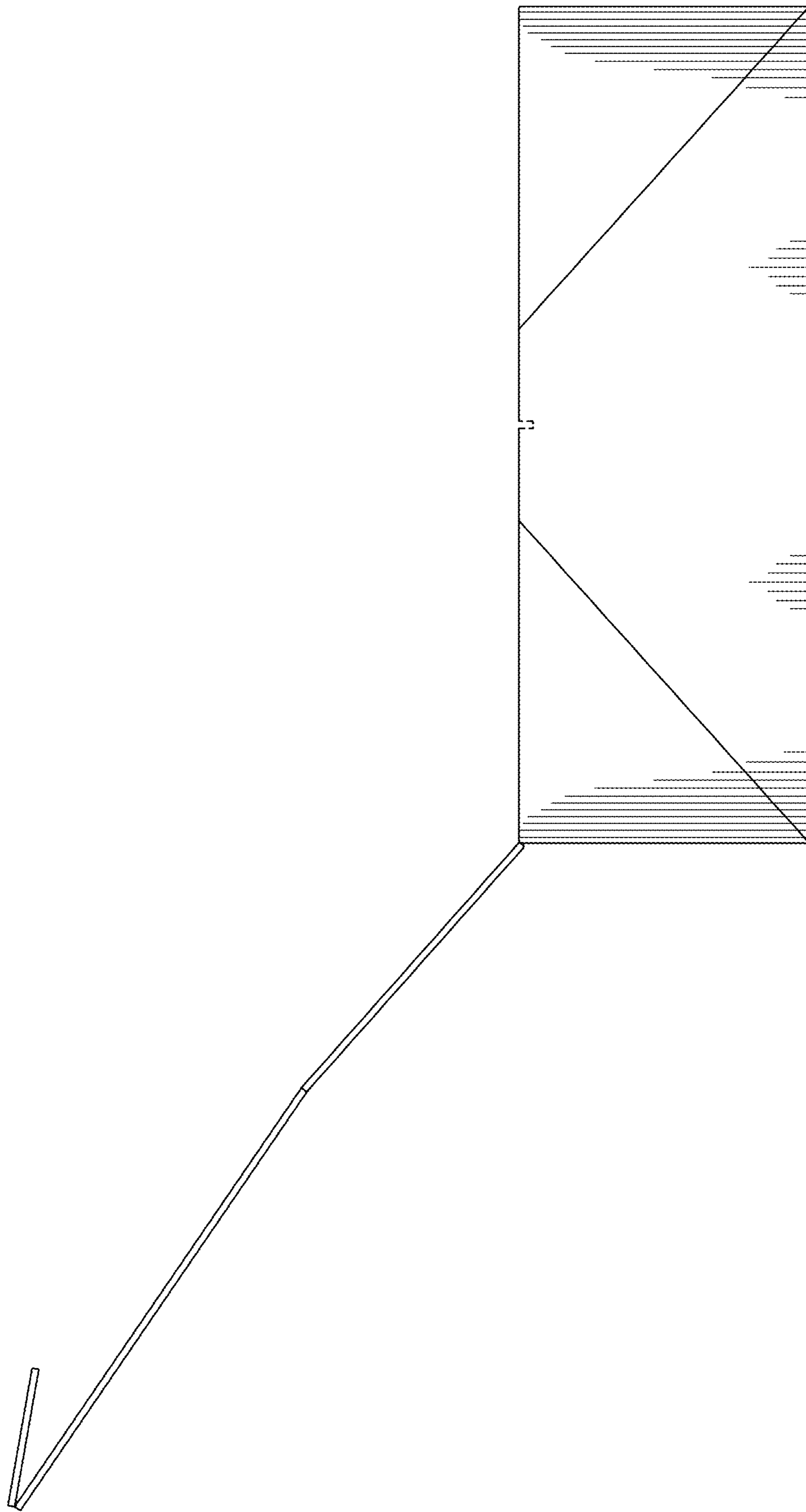

FIG. 5

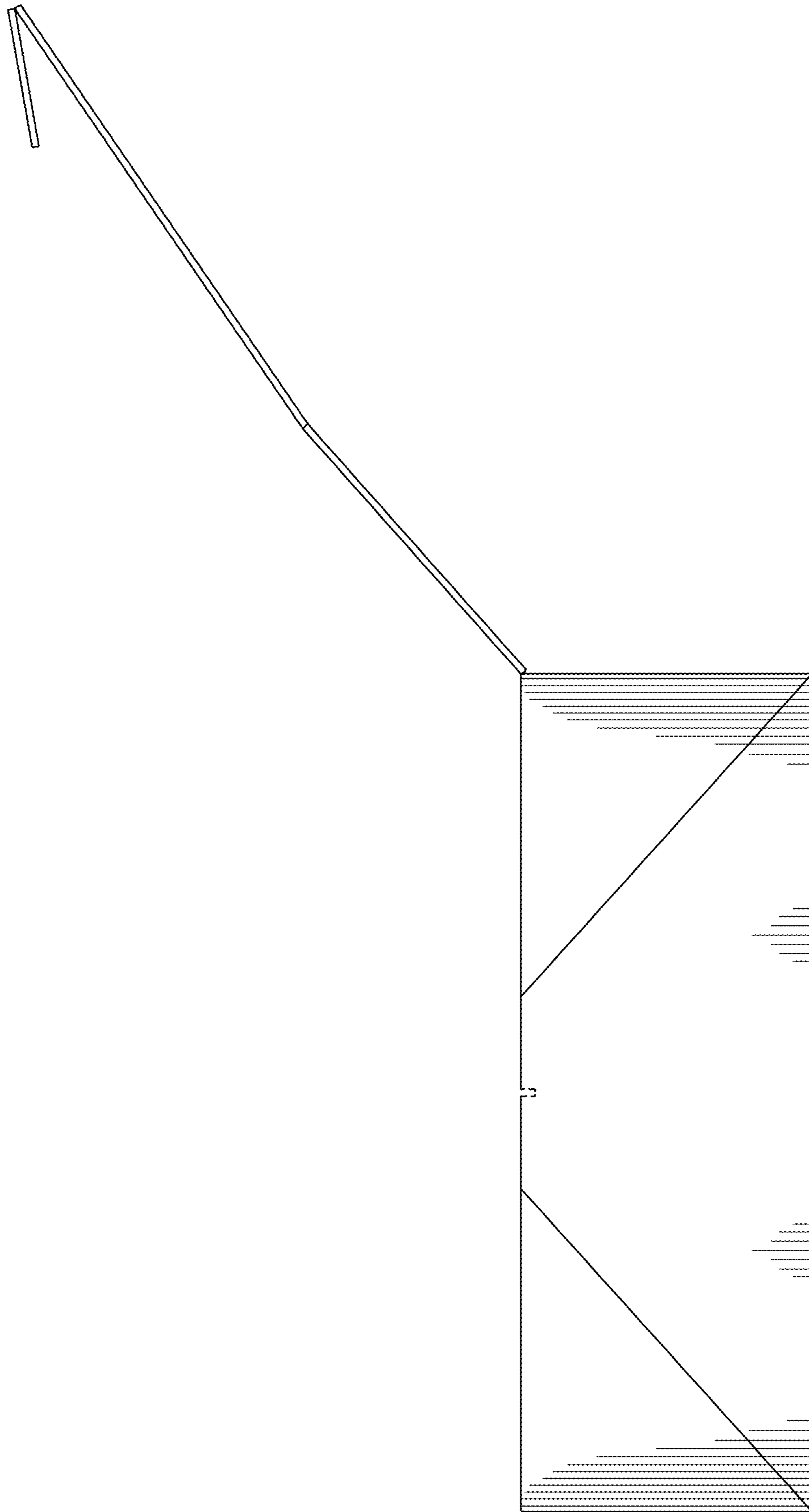

FIG. 6

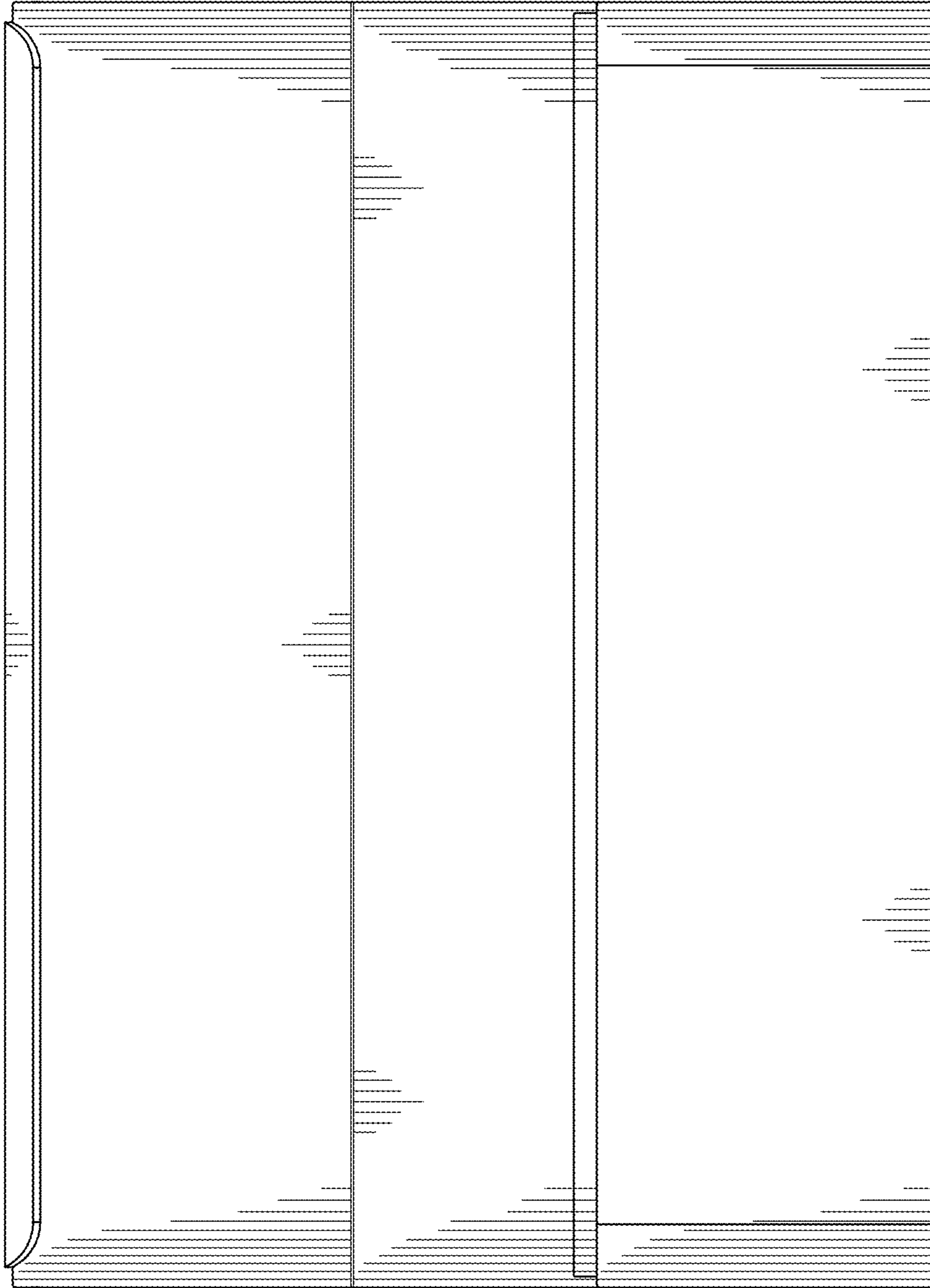

FIG. 7

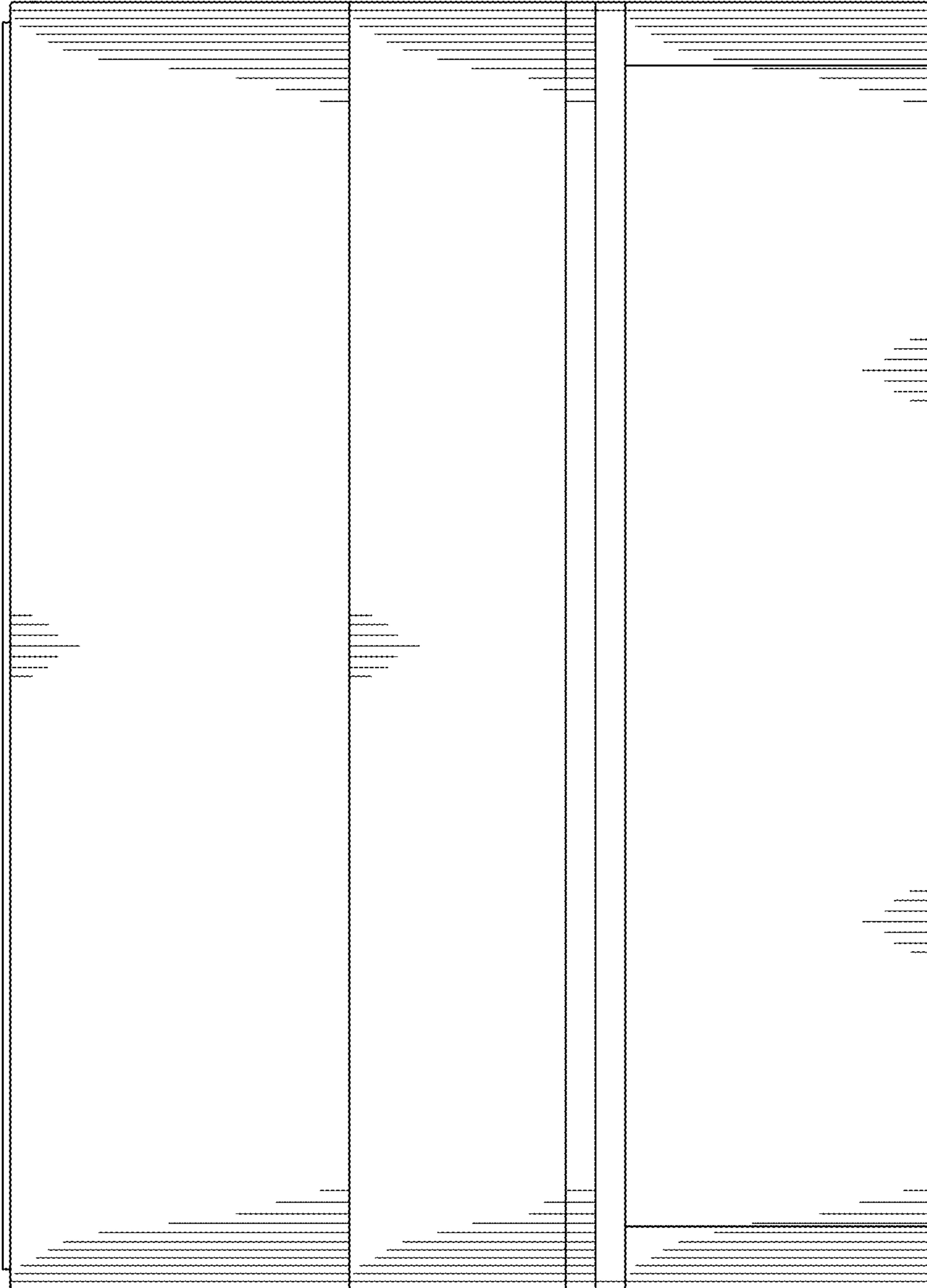

FIG. 8

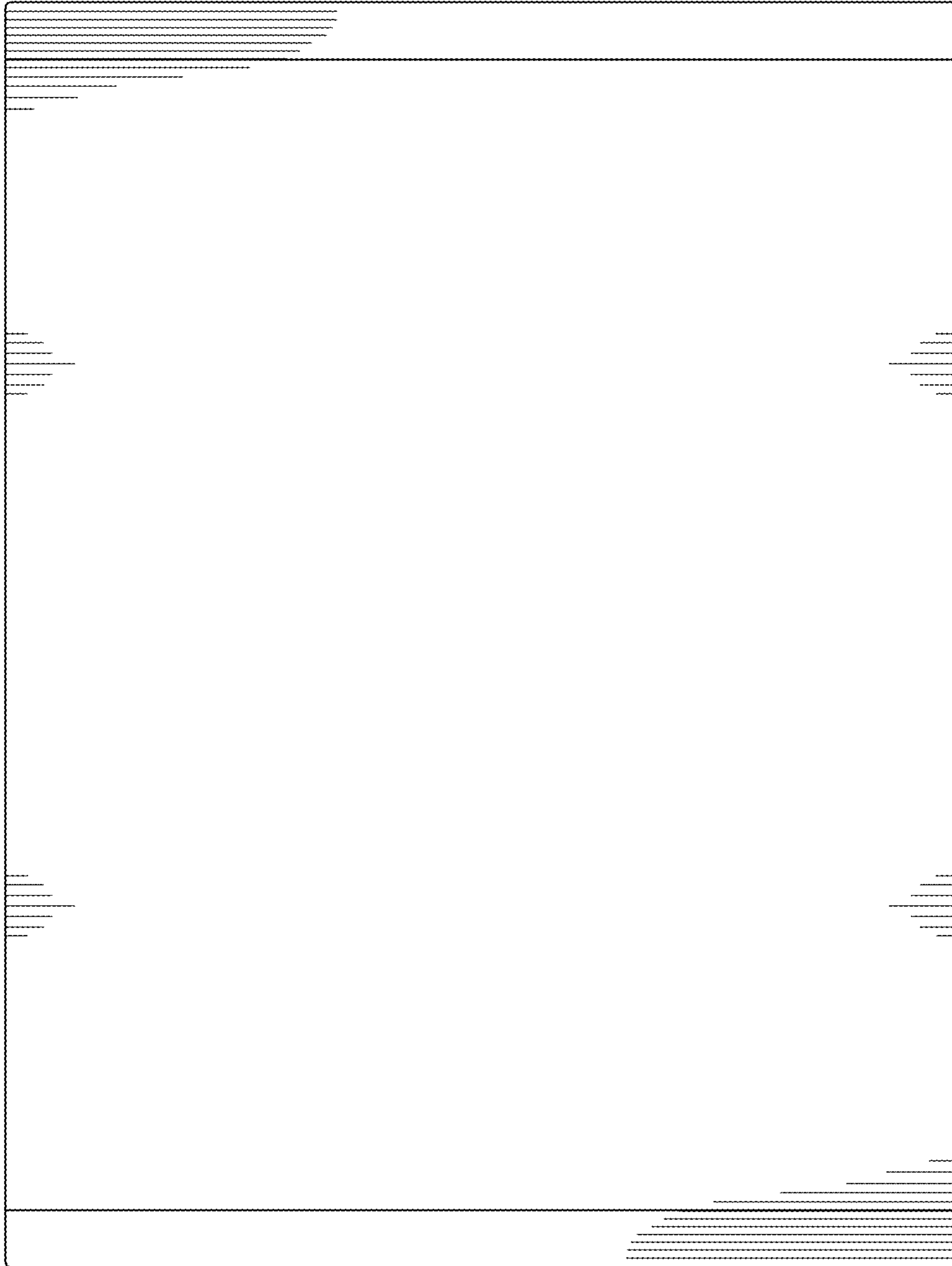

FIG. 9

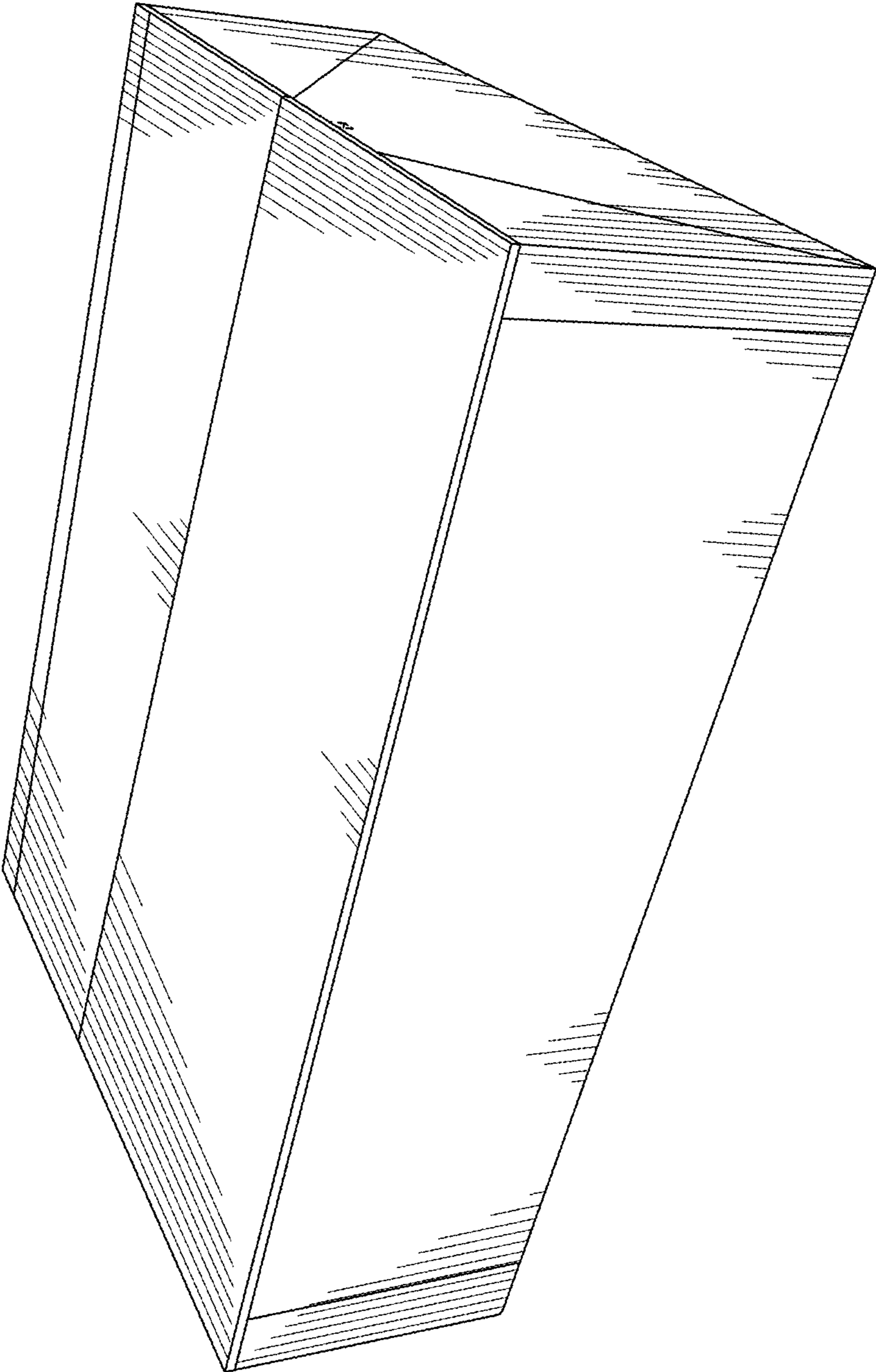

FIG. 10

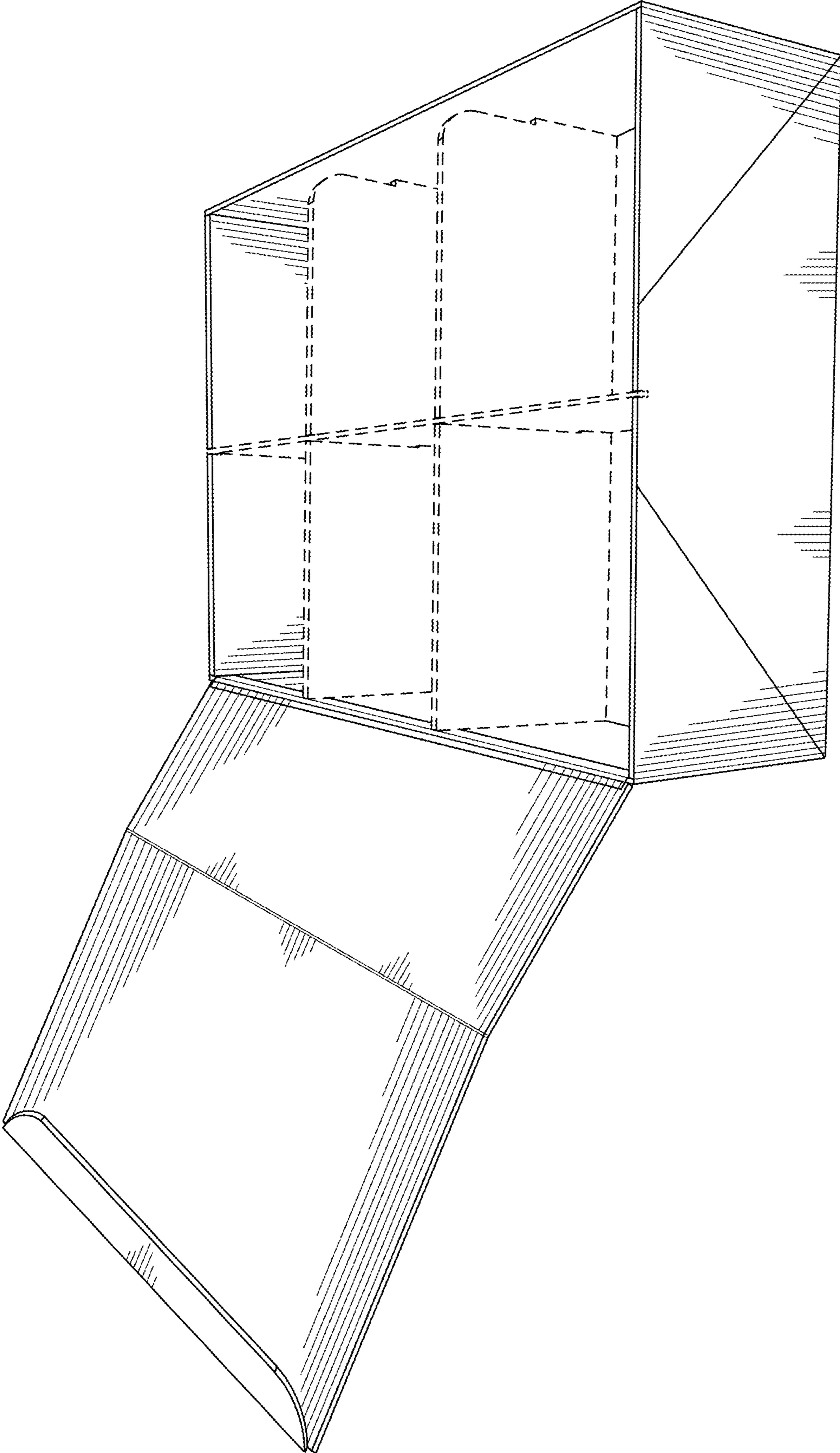

FIG. 11

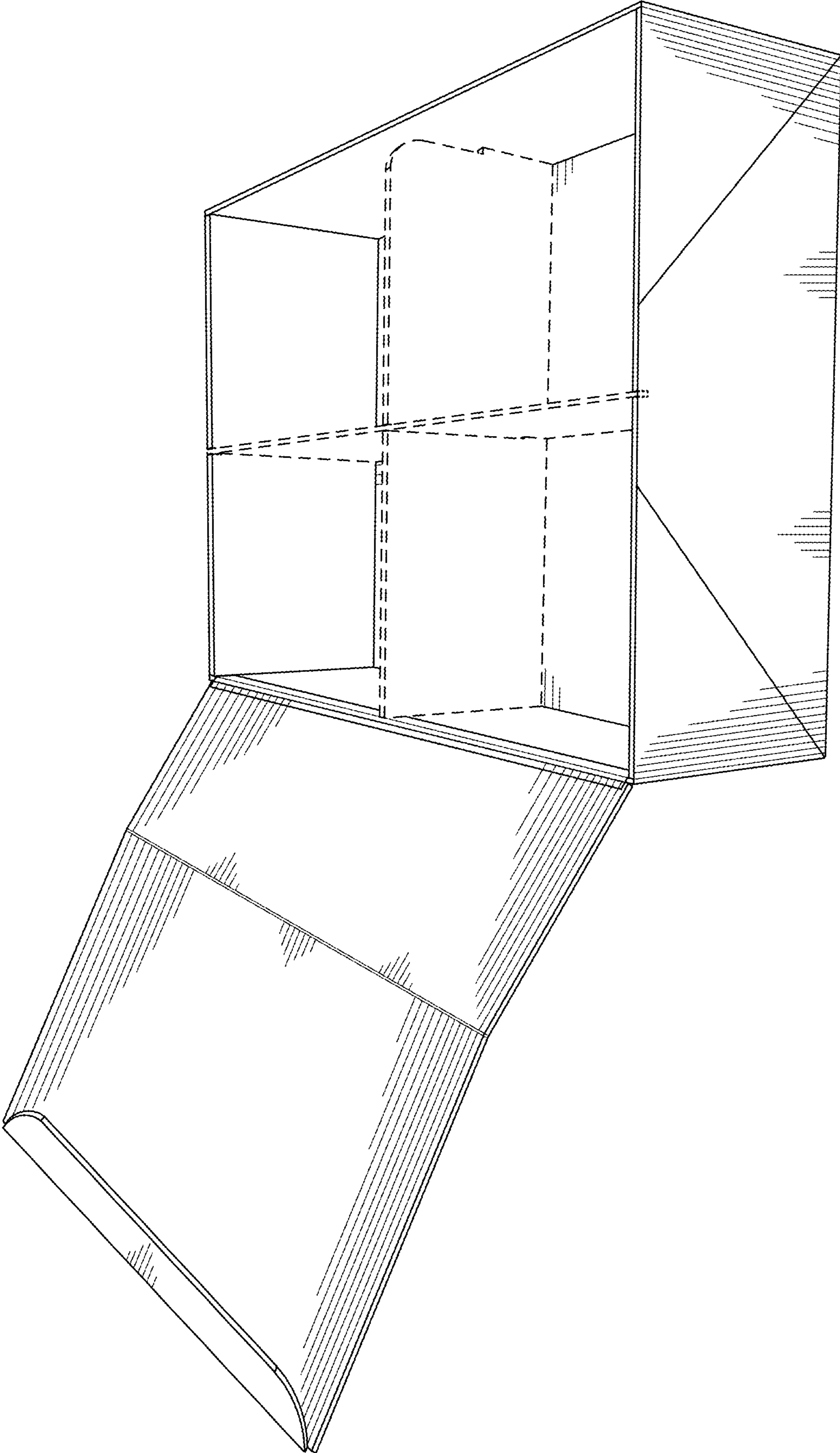

FIG. 12

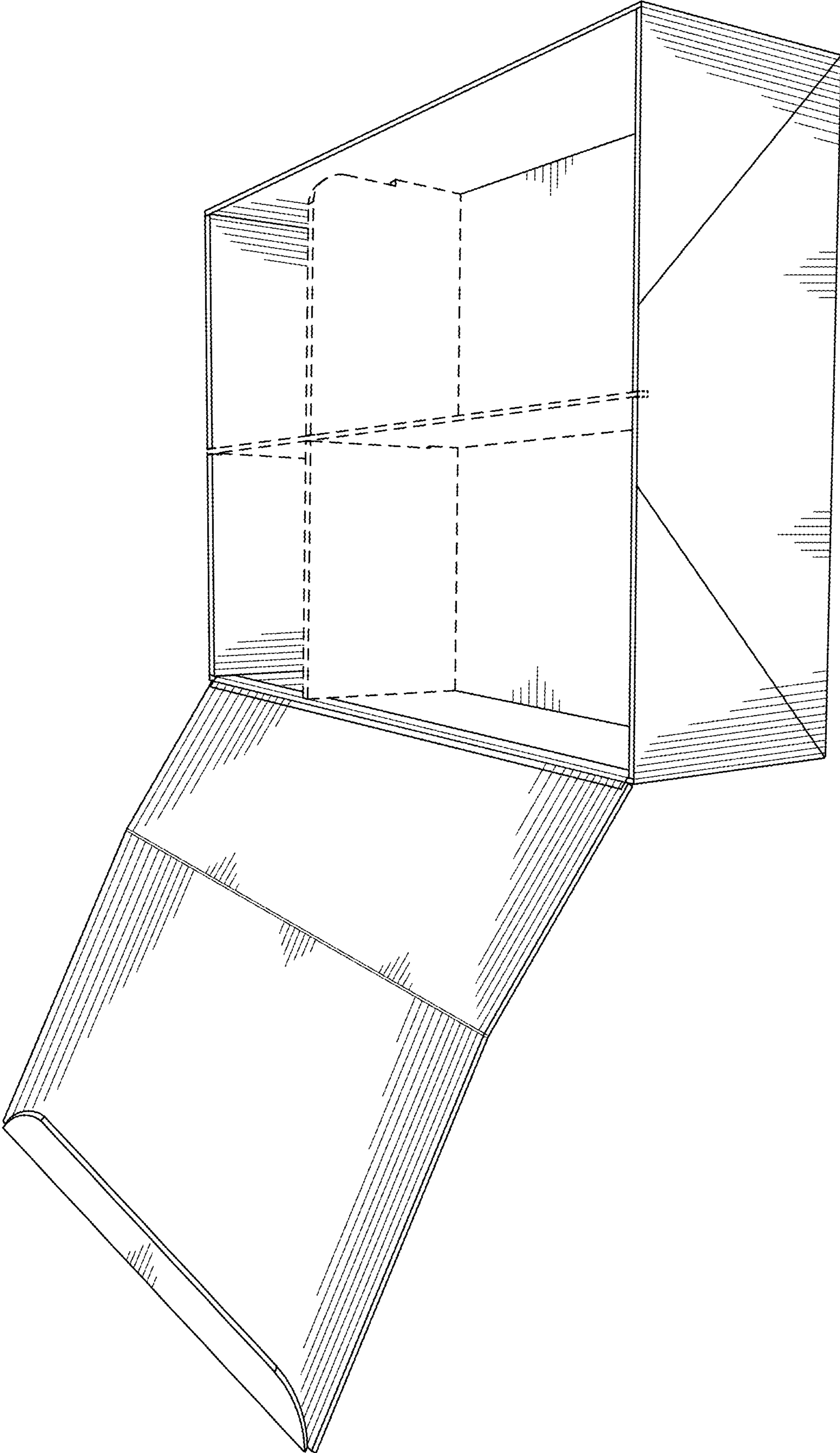

FIG. 13

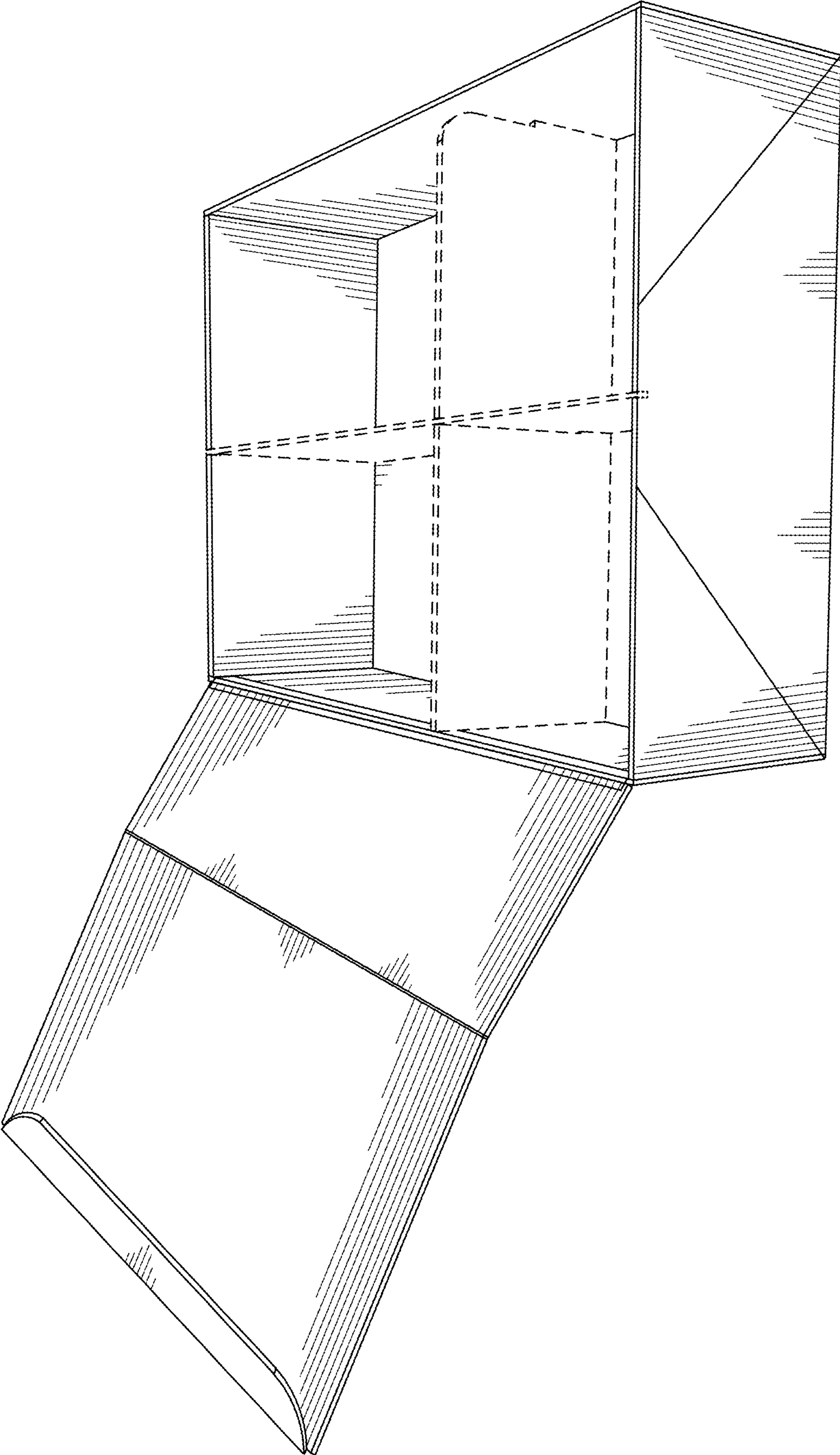

FIG. 14