



US00D958617S

(12) **United States Design Patent** (10) **Patent No.:** **US D958,617 S**
Lenorr (45) **Date of Patent:** **** Jul. 26, 2022**

(54) **INPUT MANIPULATOR**
(71) Applicant: **Kenneth Lenorr**, Union City, GA (US)
(72) Inventor: **Kenneth Lenorr**, Union City, GA (US)
(**) Term: **15 Years**
(21) Appl. No.: **29/758,571**
(22) Filed: **Nov. 17, 2020**
(51) **LOC (13) Cl.** **08-05**
(52) **U.S. Cl.**
USPC **D8/14**
(58) **Field of Classification Search**
USPC D8/14, 45, 82, 83, 107, 301; D7/395;
D24/133
CPC . A45F 5/102; A45F 2005/1086; B65D 83/04;
F16B 45/00; A44B 15/00
See application file for complete search history.

D617,798 S 6/2010 Liu
D667,828 S 9/2012 Park
D685,846 S * 7/2013 Jiang D19/906
D696,006 S * 12/2013 Lee D3/29
D704,523 S * 5/2014 Sramek D8/52
D864,685 S * 10/2019 Stephenson D8/45
D941,103 S * 1/2022 Skelton D8/14.1
2013/0061364 A1* 3/2013 Robb A41D 13/087
2/21

* cited by examiner

Primary Examiner — Philip S Hyder

(57) **CLAIM**

The ornamental design for an input manipulator, as shown and described.

DESCRIPTION

FIG. 1 is a front view of an input manipulator showing my new design;
FIG. 2 is a rear view of the input manipulator;
FIG. 3 is a right side view of the input manipulator;
FIG. 4 is a left side view of the input manipulator;
FIG. 5 is a top view of the input manipulator;
FIG. 6 is a bottom view of the input manipulator;
FIG. 7 is a top rear side perspective view of the input manipulator; and,
FIG. 8 is a bottom front side perspective view of the input manipulator.

1 Claim, 5 Drawing Sheets

(56) **References Cited**
U.S. PATENT DOCUMENTS
D305,199 S * 12/1989 Jackson D8/14
D353,239 S 12/1994 Briscoe
D383,884 S 9/1997 O'Shei
D422,121 S * 3/2000 Peck D29/114
6,141,999 A 11/2000 Whittaker
D452,529 S * 12/2001 Tsuchida D19/66
D520,326 S * 5/2006 Wu D8/93
D543,984 S 6/2007 Riou
D581,461 S * 11/2008 Li D19/163

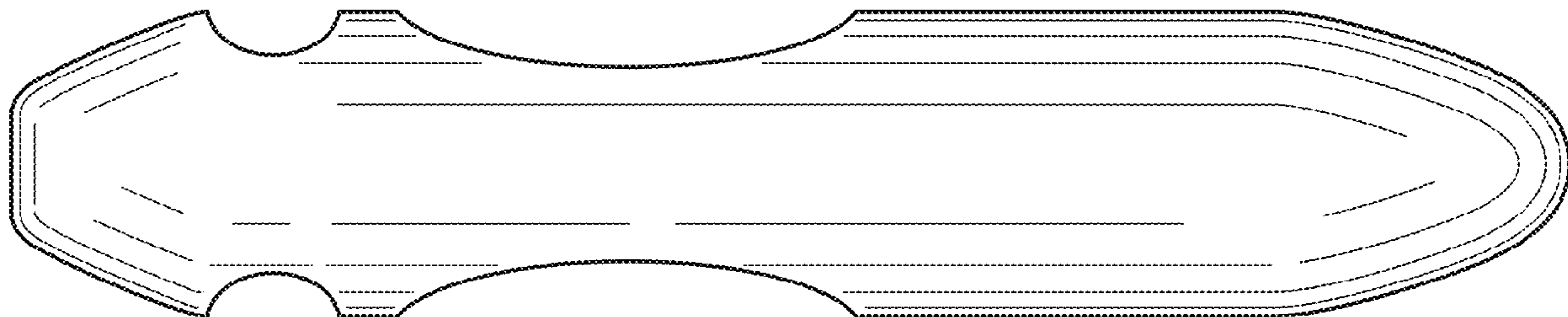

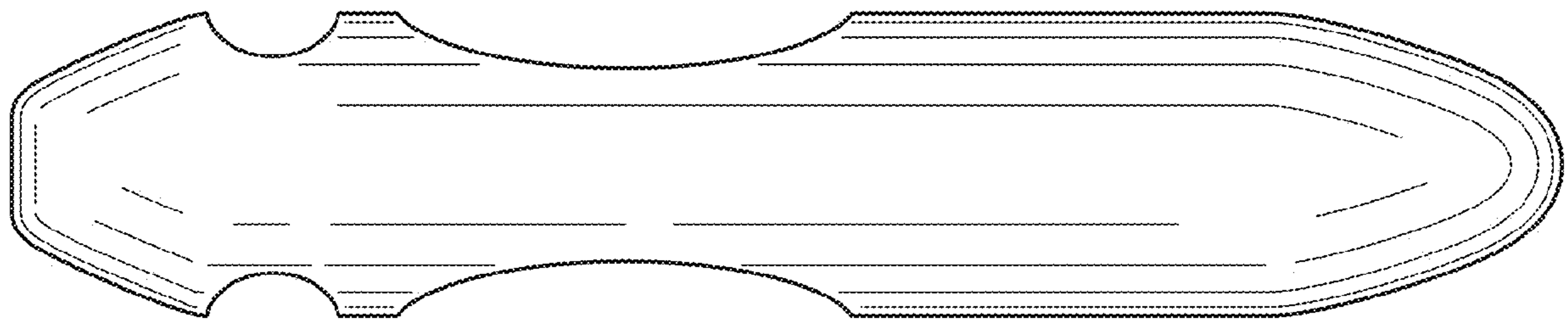

FIG. 1

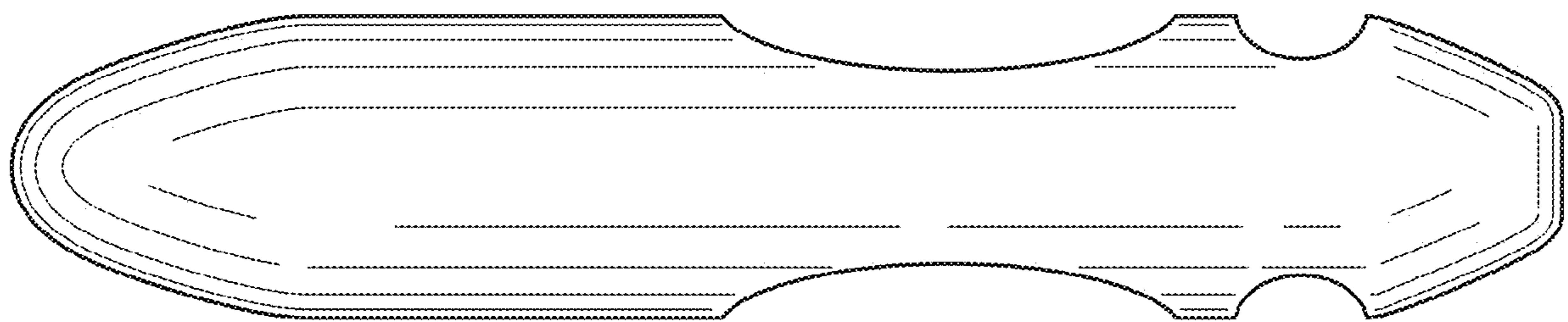

FIG. 2

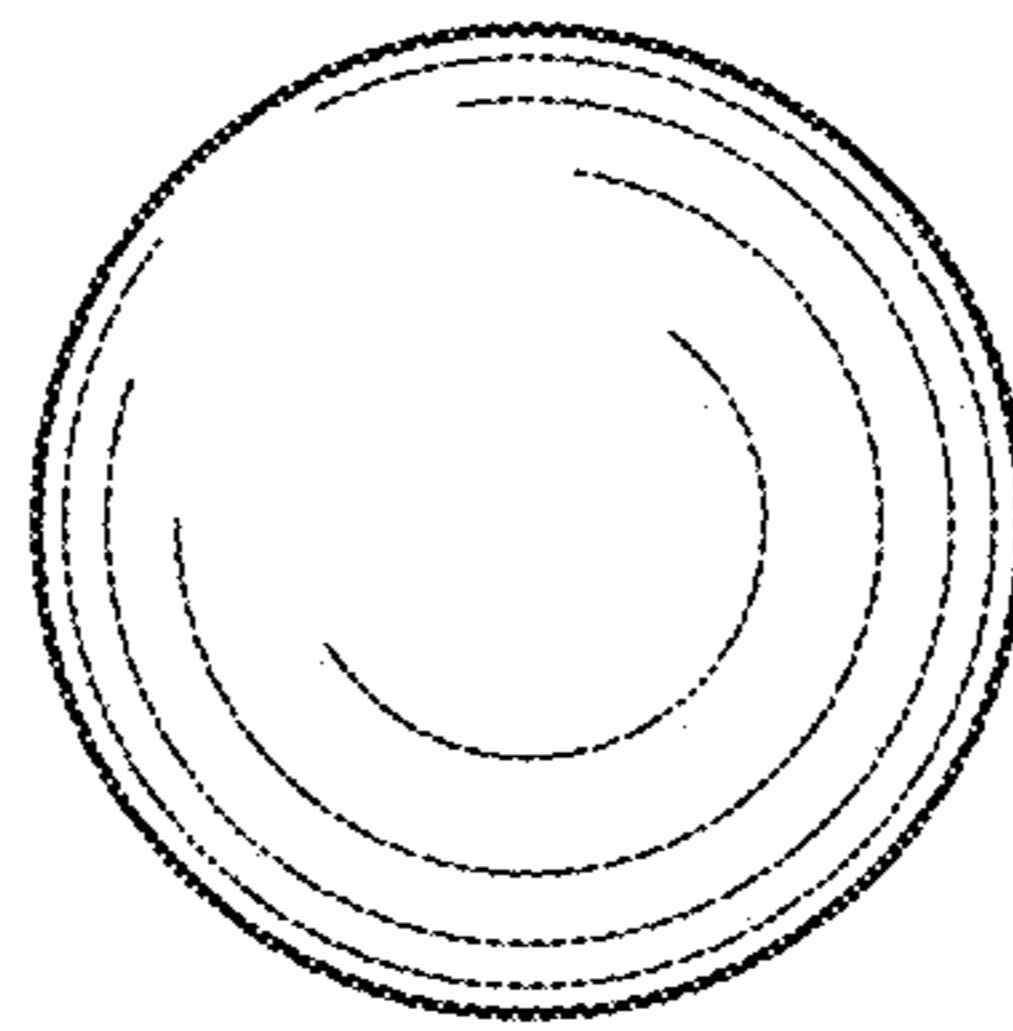

FIG. 3

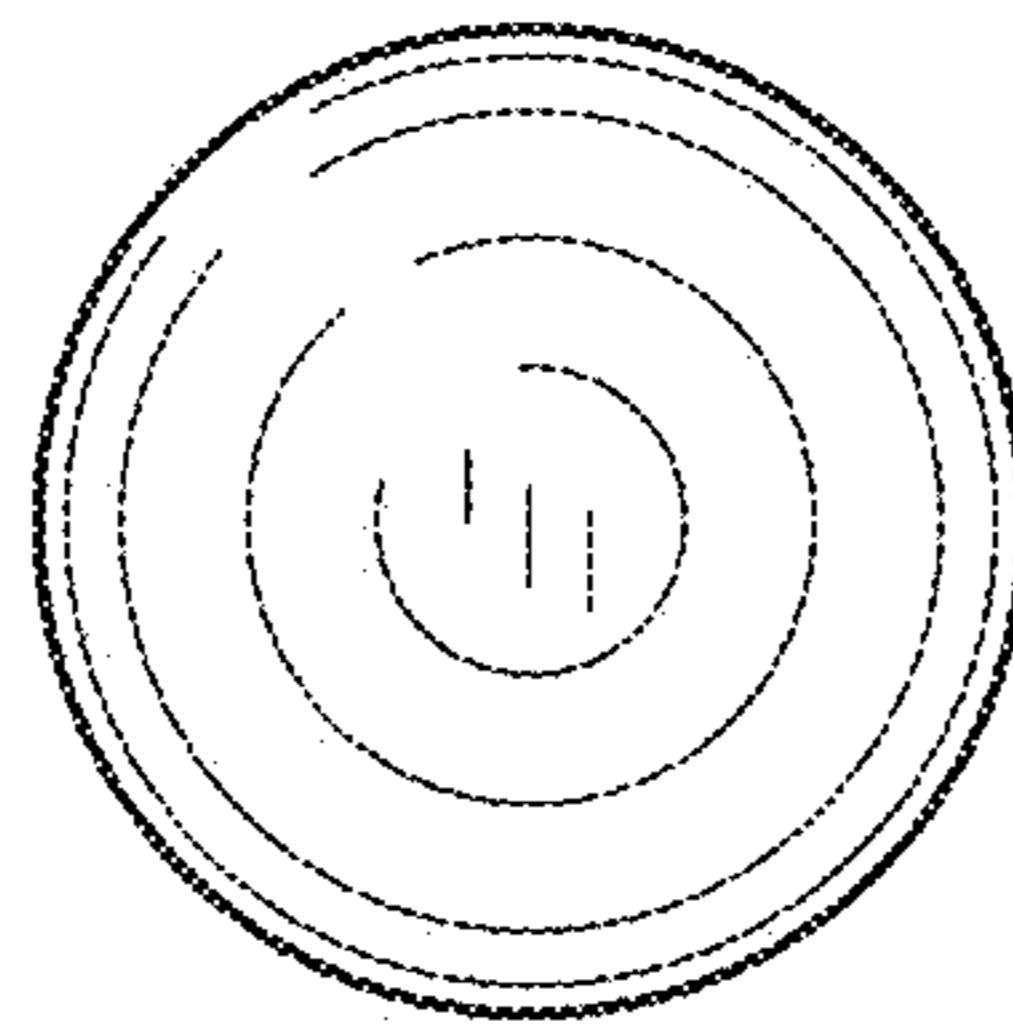

FIG. 4

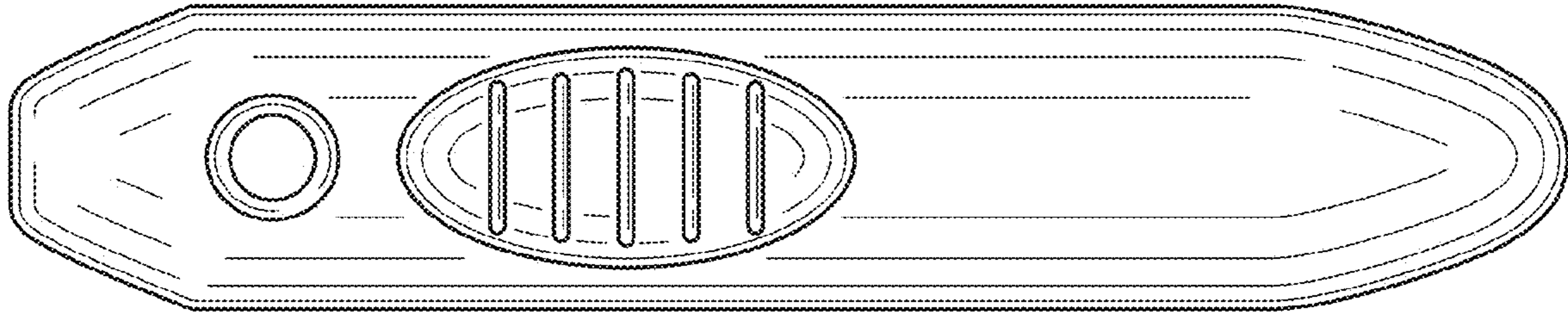

FIG. 5

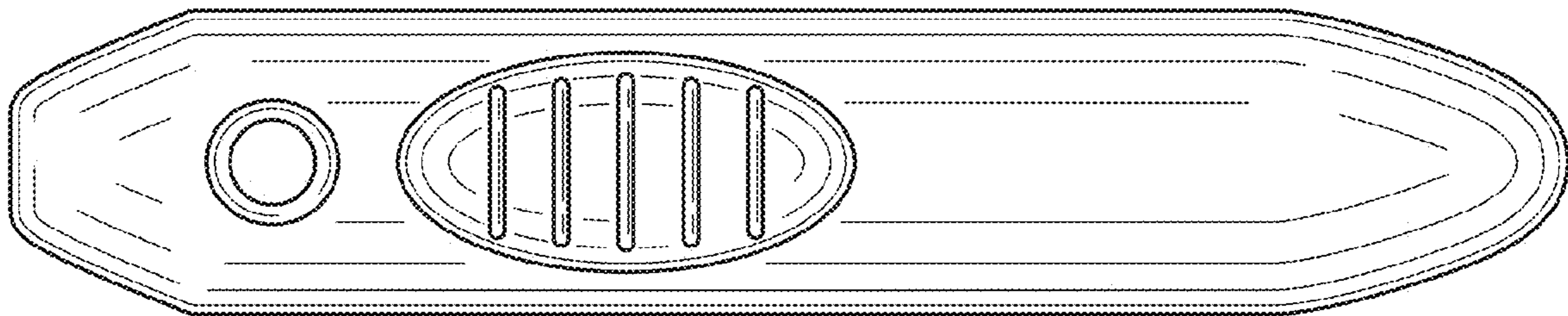

FIG. 6

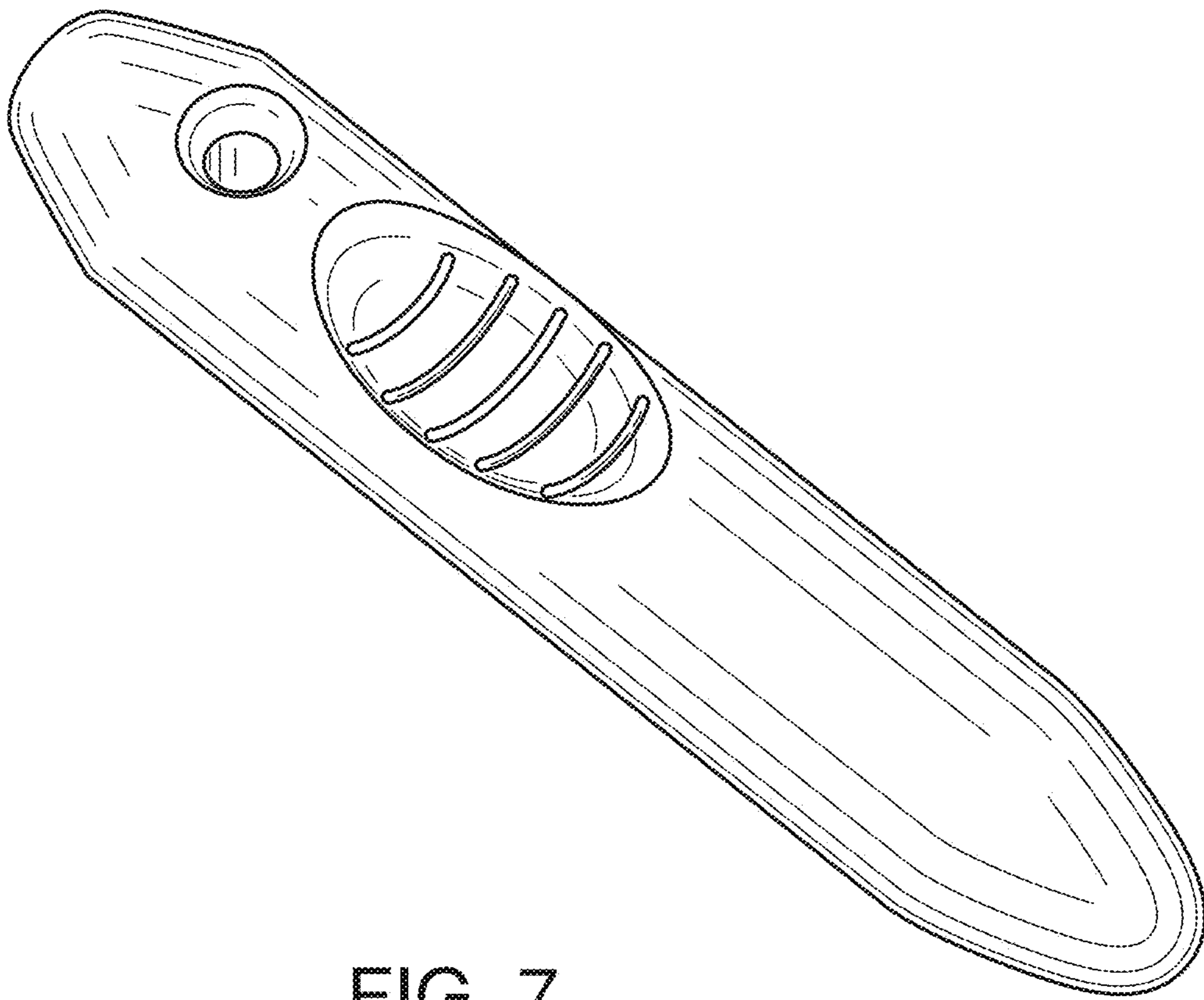

FIG. 7

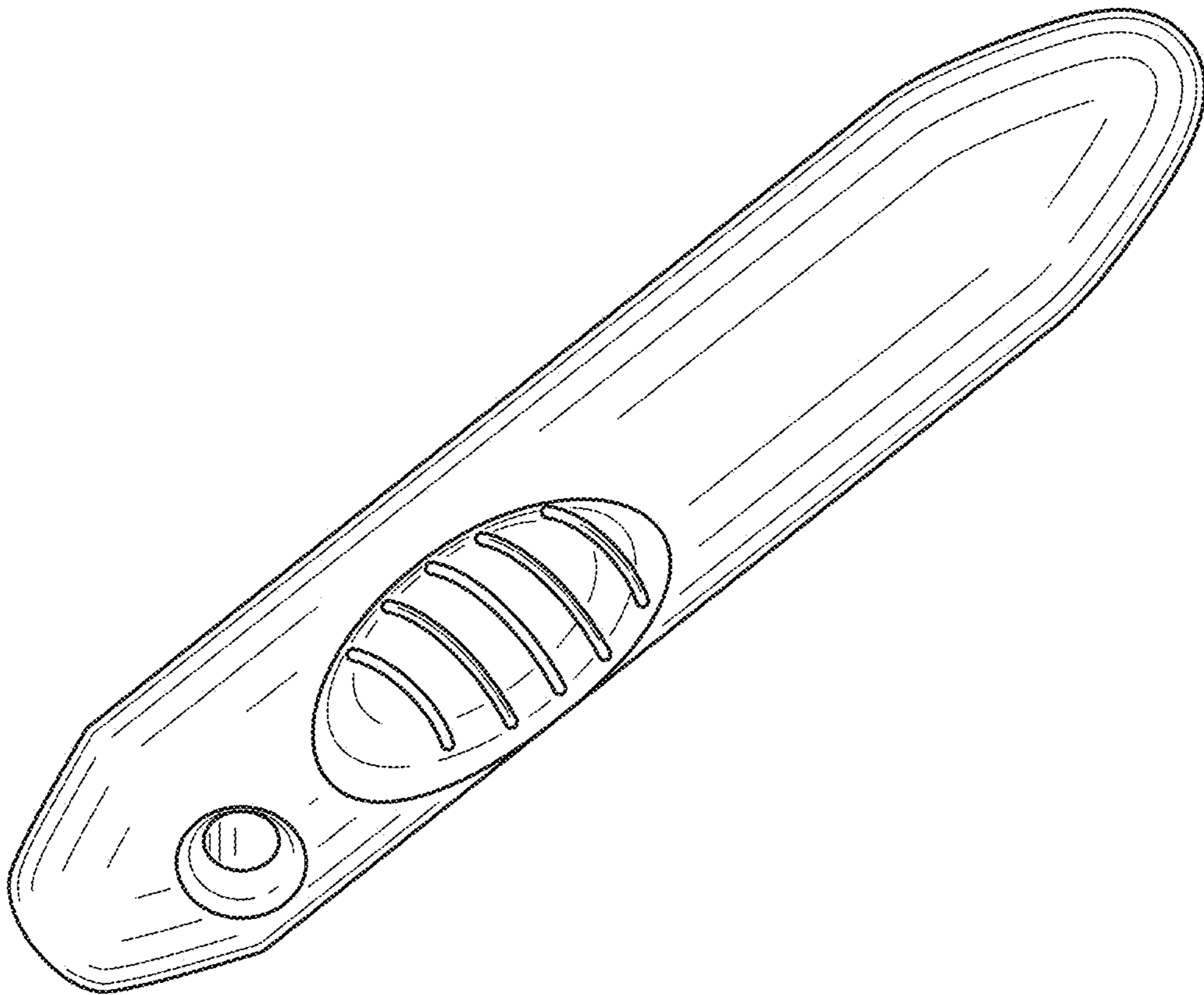

FIG. 8