



US00D958597S

(12) **United States Design Patent** (10) **Patent No.:** **US D958,597 S**
Hamann (45) **Date of Patent:** **** Jul. 26, 2022**

(54) **SINGLE SLOT UPRIGHT**

(71) Applicant: **BK Resources, Inc.**, Altamont, IL (US)
(72) Inventor: **Michael Hamann**, Effingham, IL (US)
(73) Assignee: **BK Resources, Inc.**, Altamont, IL (US)

(**) Term: **15 Years**

(21) Appl. No.: **29/754,694**

(22) Filed: **Oct. 13, 2020**

(51) **LOC (13) Cl.** **07-02**

(52) **U.S. Cl.**
USPC **D7/409**

(58) **Field of Classification Search**

USPC D7/323, 332, 335-337, 354-355,
D7/359-364, 387-388, 402, 407-409;
D19/92

CPC A21B 2/00; A21B 3/00; A21B 3/13; A21B
3/15; A21B 5/00; A21B 5/02; A23N
12/06; A23N 12/08; A23N 12/10; A47J
37/00; A47J 37/01; A47J 37/04; A47J
37/041; A47J 37/042; A47J 37/043; A47J
37/047; A47J 37/049; A47J 37/06; A47J
37/067; A47J 37/0688; A47J 37/0694;
A47J 37/07; A47J 37/0704; A47J 37/10;
A47J 37/1295; A47J 47/20; A47J
2037/00; A47J 2037/06;

(Continued)

(56) **References Cited**

U.S. PATENT DOCUMENTS

5,870,946 A * 2/1999 Dudley A47J 37/01
99/426
5,921,173 A * 7/1999 Grycan A21B 3/15
99/422

(Continued)

Primary Examiner — Ricky Pham

(74) *Attorney, Agent, or Firm* — Locke Lord LLP; Daniel
J. Fiorello

(57) **CLAIM**

The ornamental design for a single slot upright, as shown
and described.

DESCRIPTION

FIG. 1 is a front perspective view of an embodiment of the
single slot upright of the subject disclosure;
FIG. 2 is a front side elevation view of the single slot upright
of FIG. 1;
FIG. 3 is a rear side elevation view of the single slot upright
of FIG. 1;
FIG. 4 is a left side elevation view of the single slot upright
of FIG. 1;
FIG. 5 is a right side elevation view of the single slot upright
of FIG. 1;
FIG. 6 is a top plan view of the single slot upright of FIG.
1;
FIG. 7 is a bottom plan view of the single slot upright of
FIG. 1;
FIG. 8 is a rear perspective view of the single slot upright of
FIG. 1;
FIG. 9 is a front perspective view of an embodiment of the
single slot upright of the subject disclosure;
FIG. 10 is a front side elevation view of the single slot
upright of FIG. 9;
FIG. 11 is a rear side elevation view of the single slot upright
of FIG. 9;
FIG. 12 is a left side elevation view of the single slot upright
of FIG. 9;
FIG. 13 is a right side elevation view of the single slot
upright of FIG. 9;
FIG. 14 is a top plan view of the single slot upright of FIG.
9;
FIG. 15 is a bottom plan view of the single slot upright of
FIG. 9; and,
FIG. 16 is a rear perspective view of the single slot upright
of FIG. 9.
The broken lines shown in the drawings do not form part of
the claimed design.

1 Claim, 12 Drawing Sheets

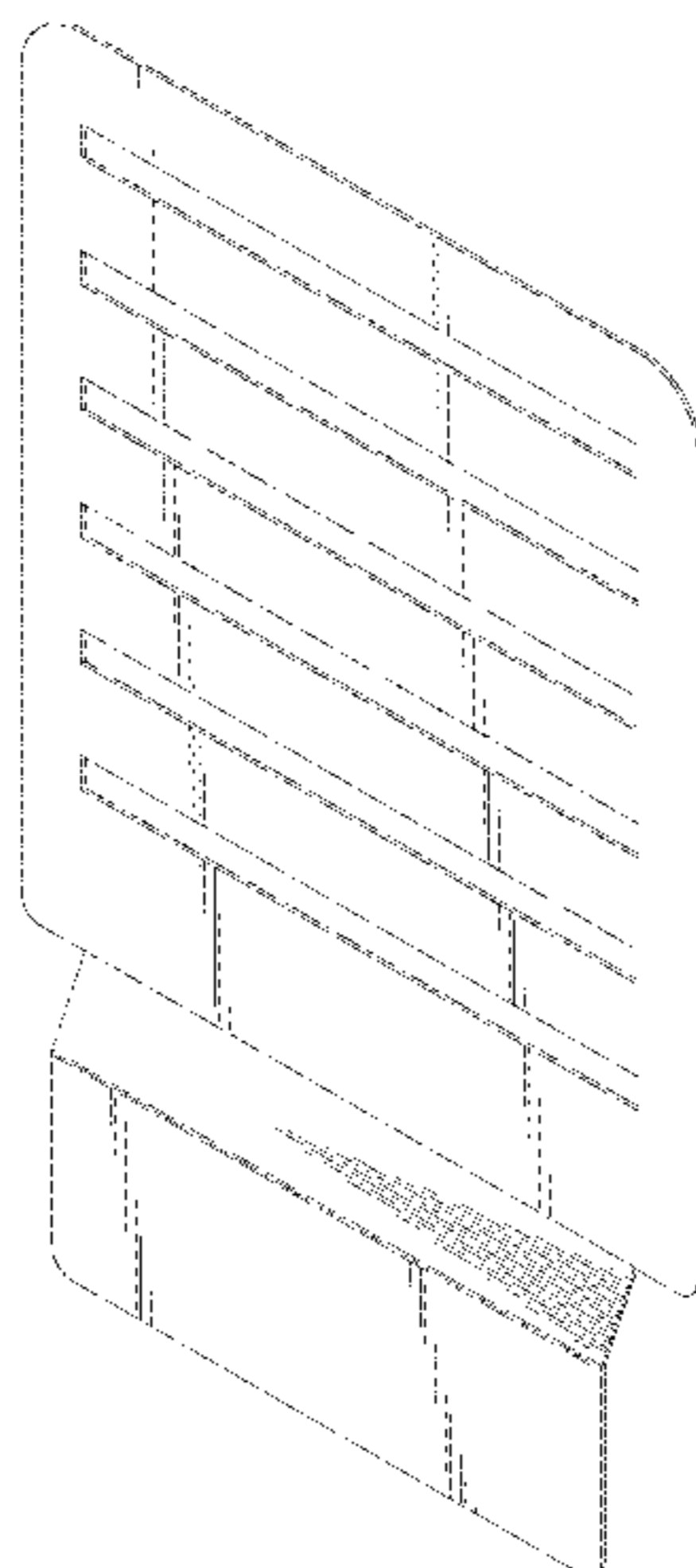

(58) **Field of Classification Search**

CPC A47J 2037/0611; A47J 2037/07; A47J
2037/0786; A47J 2037/0795; F24C 15/10;
F24C 15/12; F24C 15/14; F24C 15/16;
F24C 15/18; F24C 15/164

See application file for complete search history.

(56) **References Cited**

U.S. PATENT DOCUMENTS

D428,059 S *	7/2000	Saylor	D19/86
6,279,469 B1 *	8/2001	Bailey	A21B 3/15 220/573.1
D490,644 S *	6/2004	Groll	A21B 3/15 D7/354
D532,249 S *	11/2006	Logan	D7/354
7,340,994 B2 *	3/2008	Bruno	A47J 37/067 99/426
D581,205 S *	11/2008	Simon	A21B 3/15 D7/354
D608,146 S *	1/2010	Zemel	D7/409
D658,942 S *	5/2012	Borovicka	D7/409
D703,485 S *	4/2014	Zemel	D7/409
D784,077 S *	4/2017	Zemel	D7/354
D854,376 S *	7/2019	Hu	D7/409

* cited by examiner

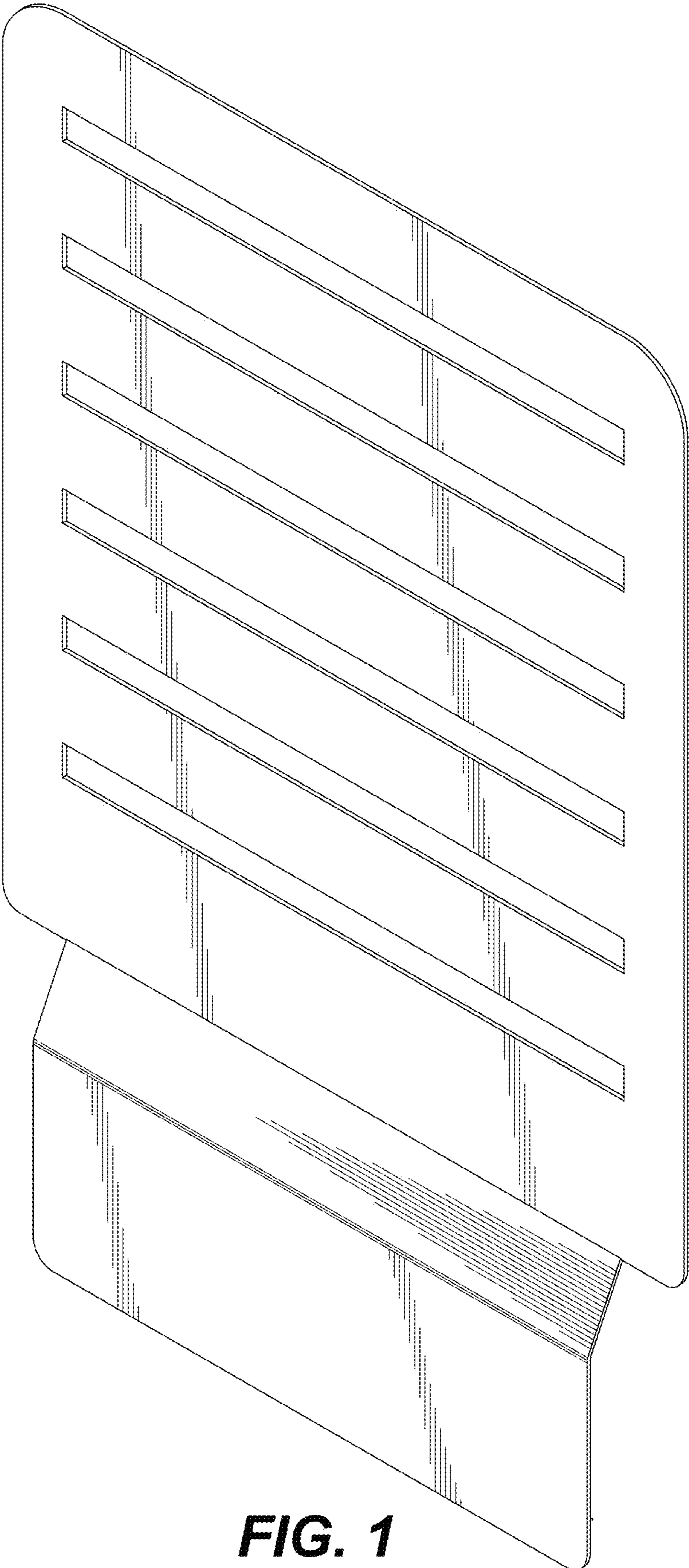

FIG. 1

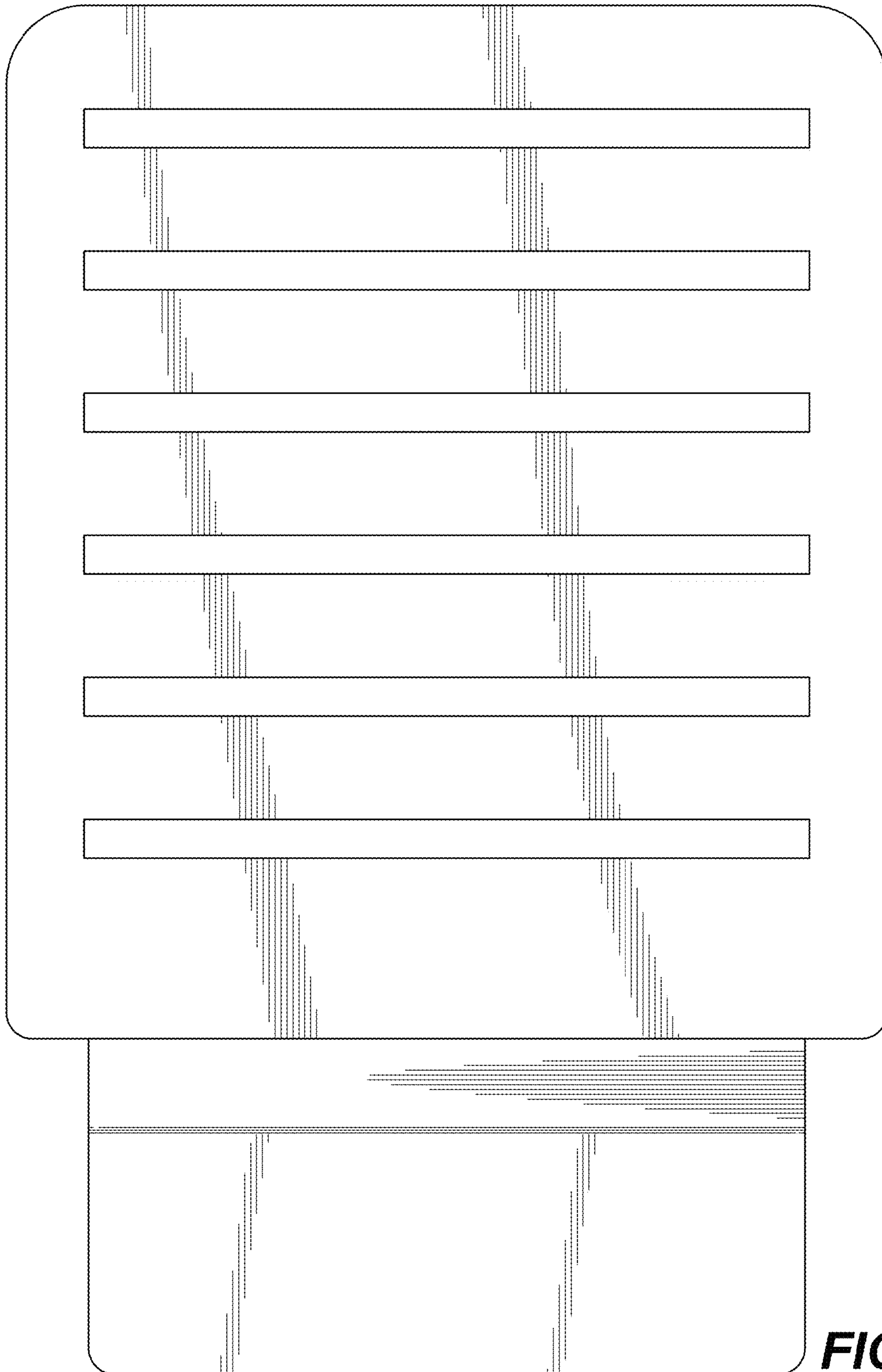

FIG. 2

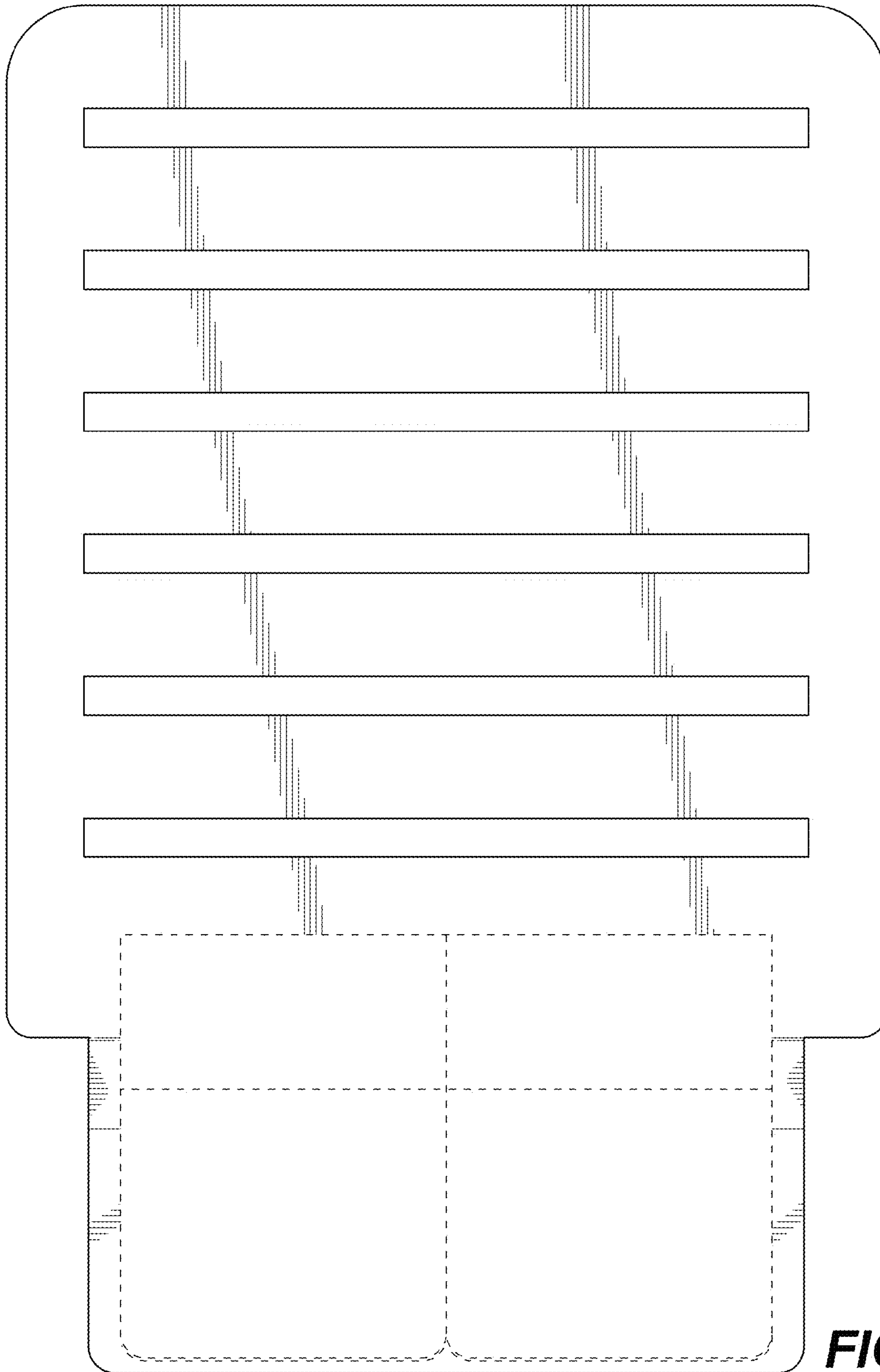

FIG. 3

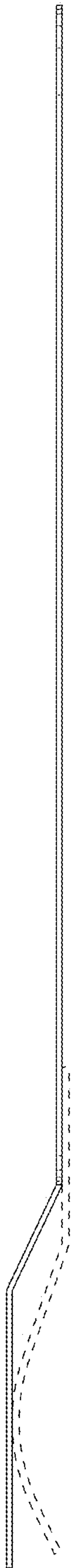

FIG. 4

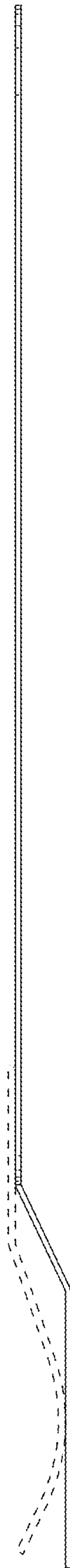

FIG. 5

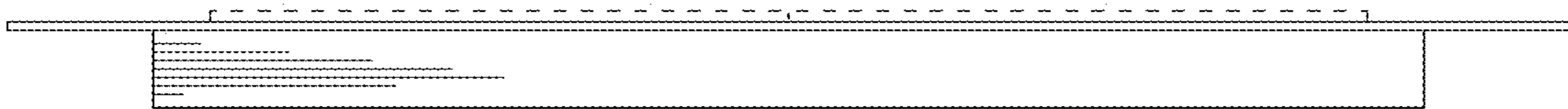

FIG. 6

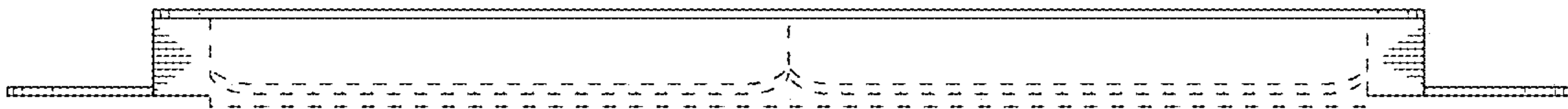

FIG. 7

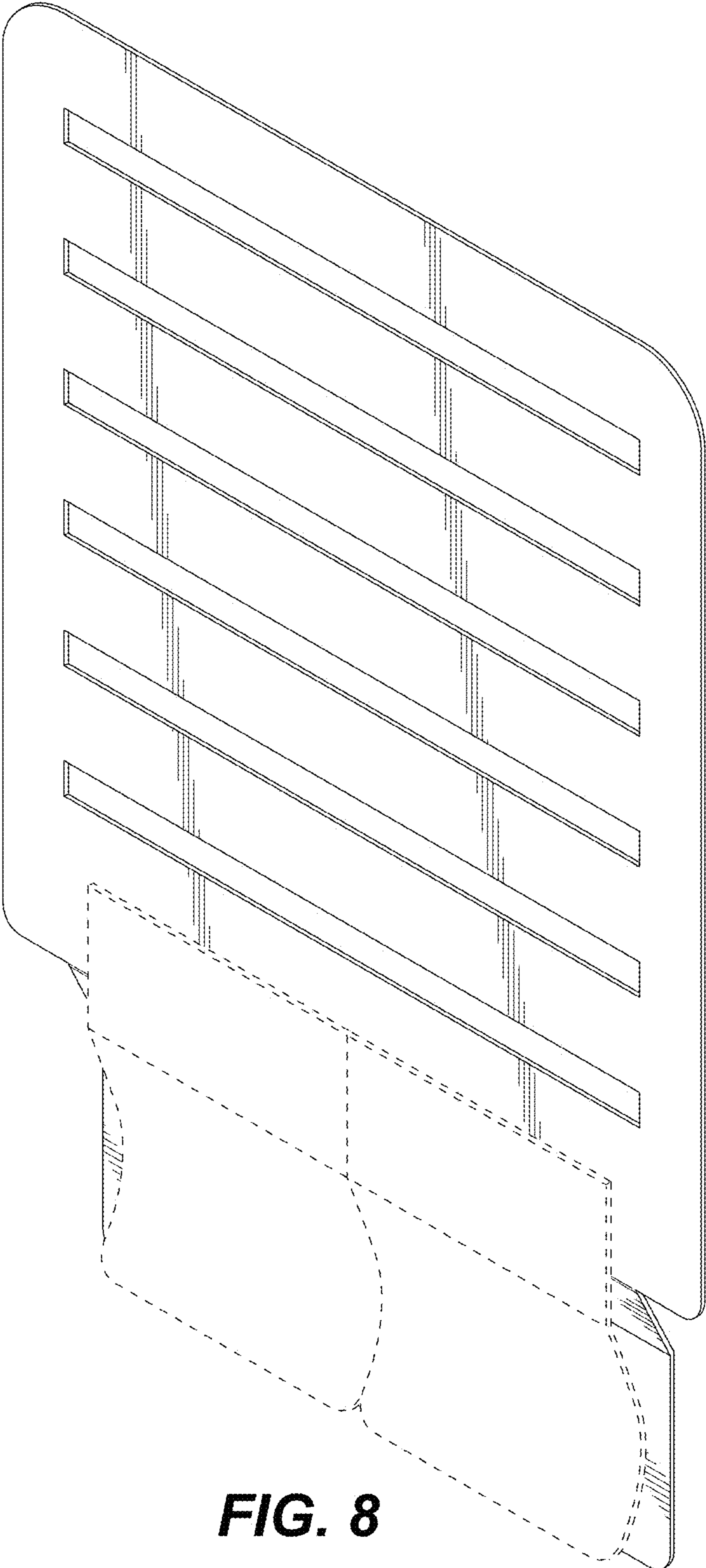

FIG. 8

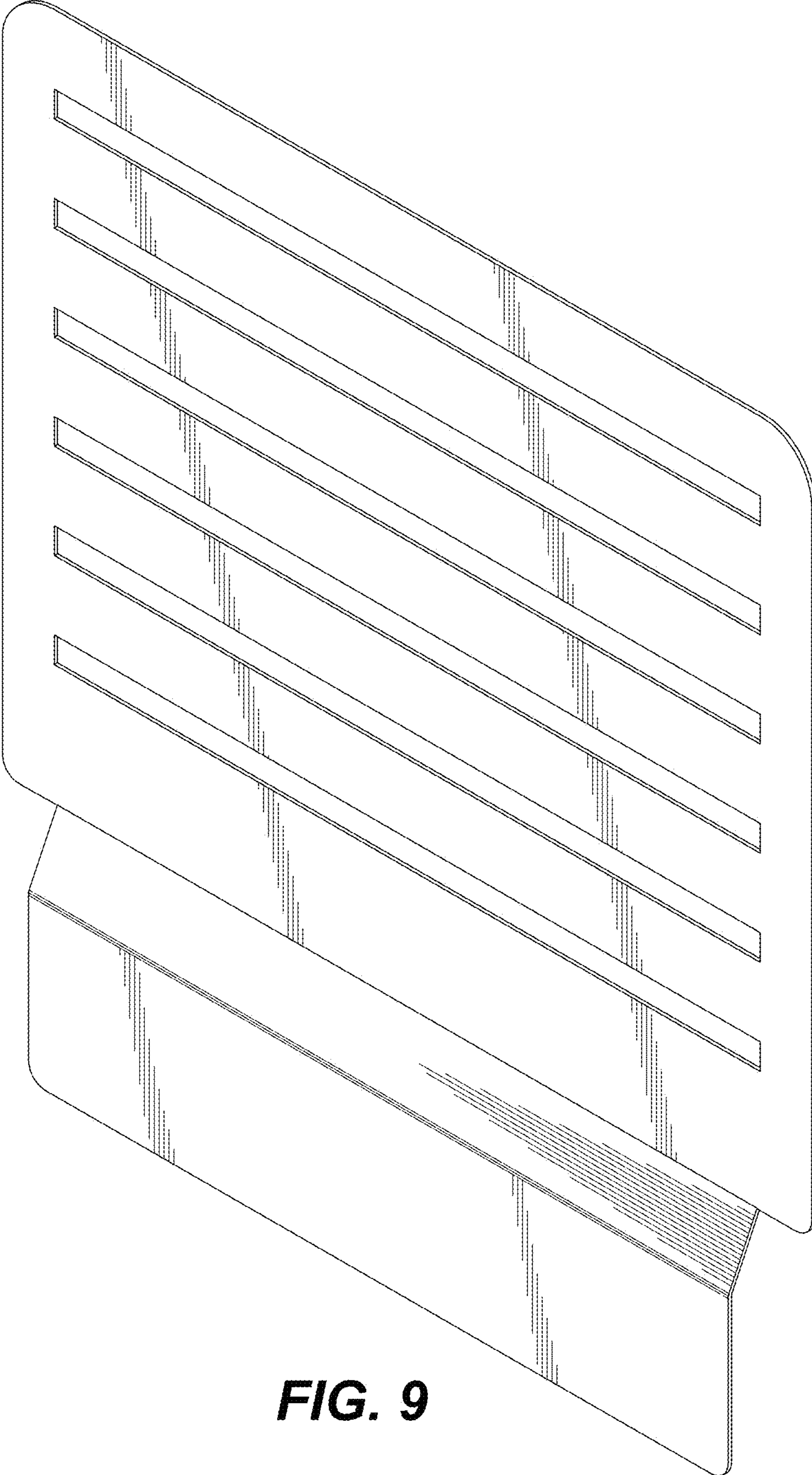

FIG. 9

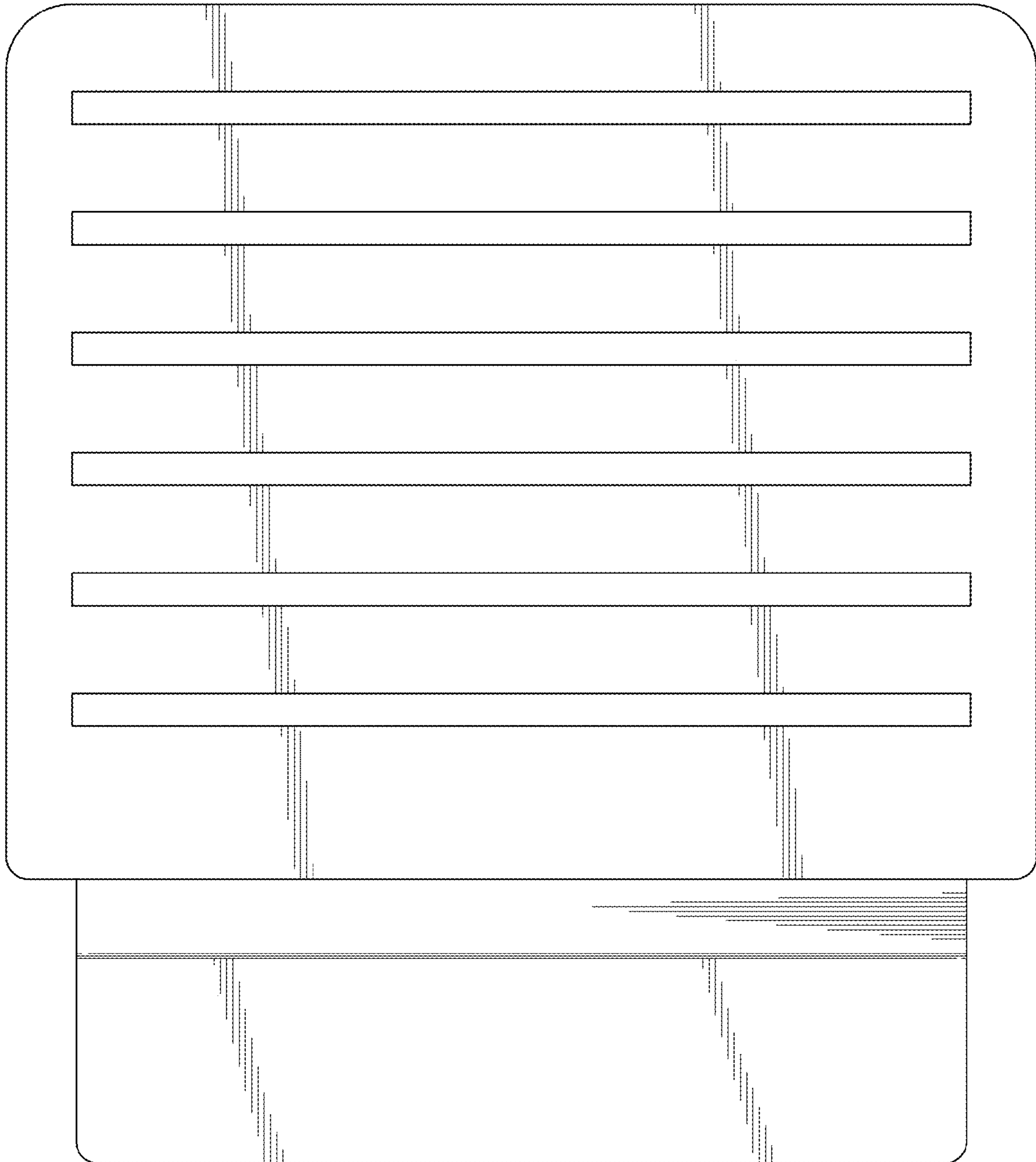

FIG. 10

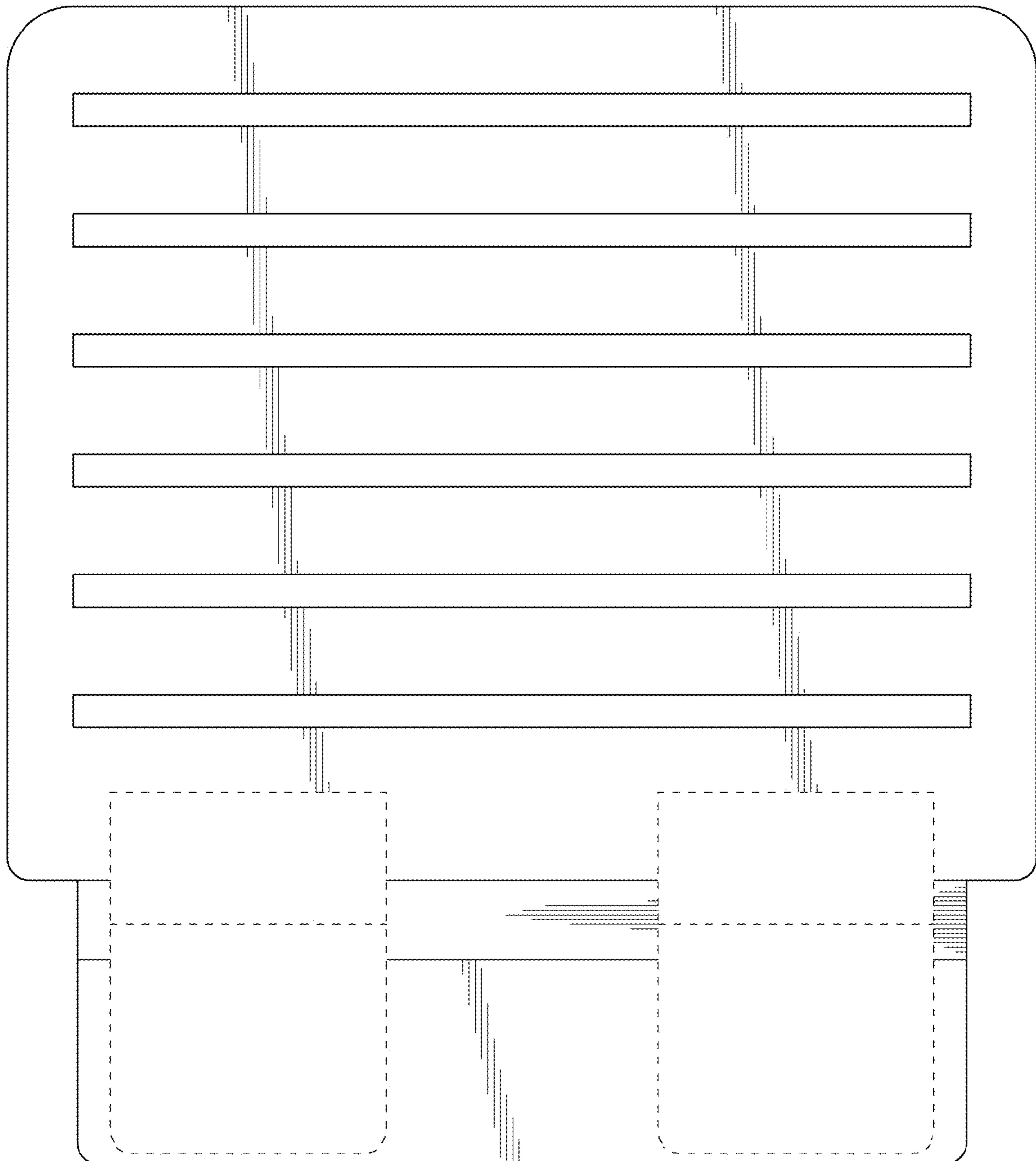

FIG. 11

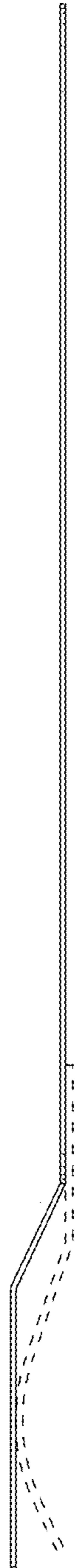

FIG. 12

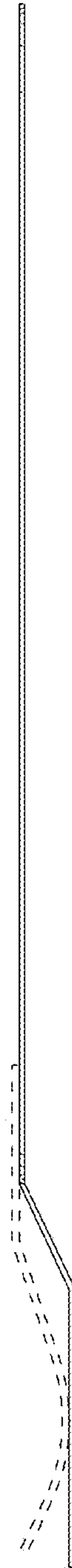

FIG. 13

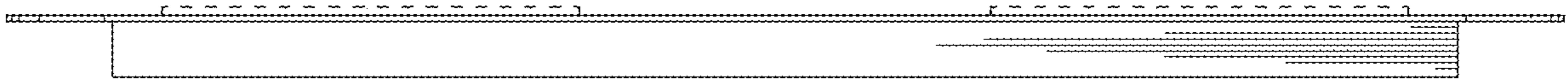

FIG. 14

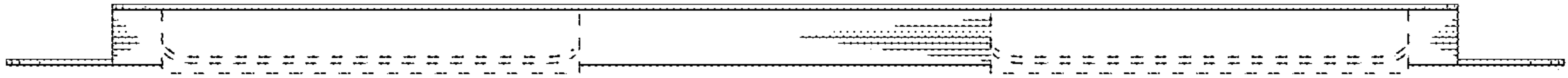

FIG. 15

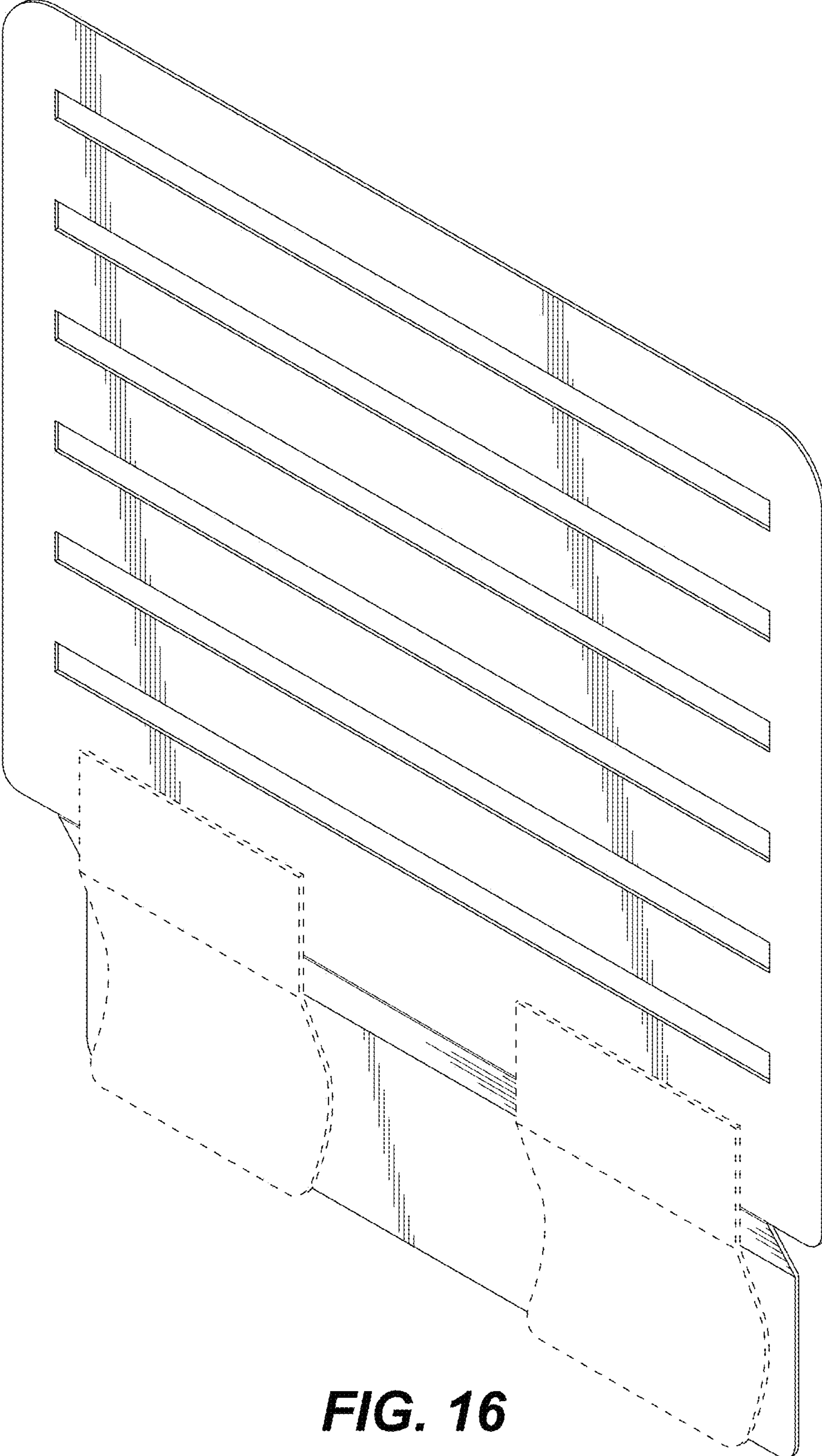

FIG. 16