



US00D958574S

(12) **United States Design Patent**  
**Jones et al.**

(10) **Patent No.:** **US D958,574 S**  
(45) **Date of Patent:** **\*\* Jul. 26, 2022**

(54) **TABLE**

- (71) Applicant: **Williams-Sonoma, Inc.**, San Francisco, CA (US)
- (72) Inventors: **Anna Jones**, Brooklyn, NY (US);  
**Andrea Parikh**, Brooklyn, NY (US)
- (73) Assignee: **Williams-Sonoma, Inc.**, San Francisco, CA (US)
- (\*\*) Term: **15 Years**

(21) Appl. No.: **29/728,417**

(22) Filed: **Mar. 18, 2020**

(51) **LOC (13) Cl.** ..... **06-03**

(52) **U.S. Cl.**  
USPC ..... **D6/691.5**

(58) **Field of Classification Search**  
USPC ..... D6/686, 690, 691, 691.3, 691.1, 691.5,  
D6/691.6

CPC .. A47B 3/00; A47B 3/002; A47B 3/08; A47B 3/0812; A47B 3/0818; A47B 3/0912; A47B 2003/006; A47B 2003/0821; A47B 7/00; A47B 13/00; A47B 13/02; A47B 13/04; A47B 13/06; A47B 13/08; A47B 21/00; A47B 2200/0001; A47B 2200/0011; A47B 2200/002; A47B 2200/0035; A47B 2200/005; A47B 13/10; A47B 13/12; A47B 17/00; A47B 17/003; A47B 17/06; A47B 21/0314; A47B 2021/0307; A47B 2021/0321; A47B 2021/0335; A47B 2200/0003; A47B 2200/0004; A47B

(Continued)

(56) **References Cited**

**U.S. PATENT DOCUMENTS**

D99,565 S \* 5/1936 Talbert ..... D6/656.16  
D113,215 S \* 2/1939 Birkmeyer ..... D6/691.5

(Continued)

**FOREIGN PATENT DOCUMENTS**

CN 304069169 \* 9/2016  
KR 300319957 \* 3/2003

**OTHER PUBLICATIONS**

Live Edge Walnut Table by Loewen Design Studios, first available: Jun. 4, 2021. Etsy.com [online], [site visited Nov. 26, 2021], Internet URL: <https://www.etsy.com/listing/708453894/live-edge-walnut-table-with-walnut-panel> (Year: 2021).\*

(Continued)

*Primary Examiner* — Steven J Czyz

*Assistant Examiner* — Hillary Catherine Shepard

(74) *Attorney, Agent, or Firm* — Cook Alex Ltd.

(57) **CLAIM**

The ornamental design for a table, as shown and described.

**DESCRIPTION**

FIG. 1 is a perspective view of a first embodiment of a table; FIG. 2 is a front elevational view thereof, the opposite side of which is a mirror image; FIG. 3 is a left side elevational view thereof, the opposite side of which is a mirror image; FIG. 4 is a top plan view thereof; FIG. 5 is a bottom plan view thereof; FIG. 6 is a perspective view of a second embodiment of a table; FIG. 7 is a front elevational view thereof, the opposite side of which is a mirror image; FIG. 8 is a left side elevational view thereof, the opposite side of which is a mirror image; FIG. 9 is a top plan view thereof; and, FIG. 10 is a bottom plan view thereof. The broken lines depict portions of the article that form no part of the claimed design.

**1 Claim, 10 Drawing Sheets**

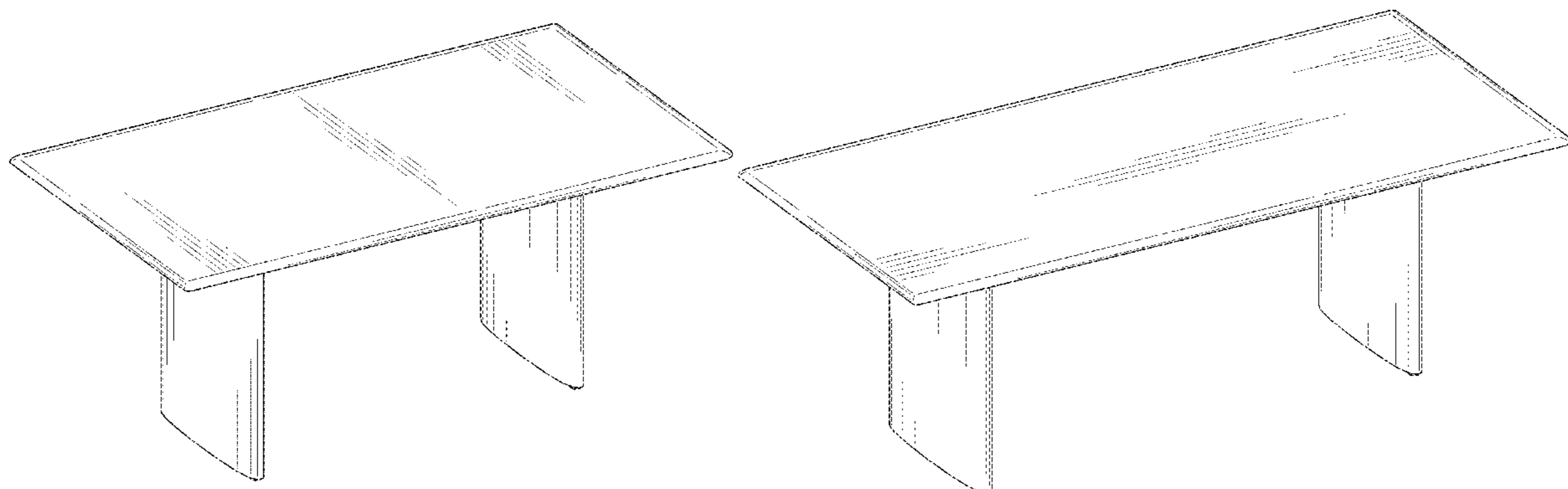

(58) **Field of Classification Search**

CPC ..... 47/0058; A47B 11/00; A47B 3/06; A47B  
7/0091; A47B 7/0025; A47B 7/0058;  
A47B 7/0008

See application file for complete search history.

D884,400 S \* 5/2020 Chen ..... D6/705  
D888,444 S \* 6/2020 Kimmel ..... D6/349  
D926,504 S \* 8/2021 Van Faasen ..... D6/691  
D948,901 S \* 4/2022 Velez ..... D6/691.5  
2022/0007830 A1 \* 1/2022 Ren ..... A47B 3/002

(56) **References Cited**

U.S. PATENT DOCUMENTS

2,943,898 A \* 7/1960 Knuth ..... F16B 12/52  
108/156  
D225,950 S \* 1/1973 Kienel ..... D6/691.5  
D225,951 S \* 1/1973 Kienel ..... D6/691.5  
D247,080 S \* 1/1978 Robinson ..... D6/690  
D249,216 S \* 9/1978 Blaser ..... D6/708  
D270,411 S \* 9/1983 DeGregori ..... D6/691.5  
D308,615 S \* 6/1990 Hubert ..... D6/691.1  
D347,945 S \* 6/1994 Walters-Leiter ..... D6/353  
D362,140 S \* 9/1995 Pedersen ..... D6/691.5  
D386,631 S \* 11/1997 Meier ..... D6/656.1  
D415,360 S \* 10/1999 Lewis ..... D6/349  
D456,643 S \* 5/2002 Harner ..... D6/691.5  
D466,337 S \* 12/2002 Feng ..... D6/689  
D505,282 S \* 5/2005 Miyakawa ..... D6/691.8  
D553,394 S \* 10/2007 Geraghty ..... D6/692  
D583,577 S \* 12/2008 Wicha ..... D6/349  
D604,063 S \* 11/2009 Oshinomi ..... D6/656.16  
8,096,244 B1 \* 1/2012 Bockheim ..... A47B 87/002  
108/64  
D668,893 S \* 10/2012 Lehman-Smith ..... D6/708  
D693,610 S \* 11/2013 Denby ..... D6/690  
D711,171 S \* 8/2014 Brielmaier ..... D6/675  
D727,644 S \* 4/2015 Sorel ..... D6/349  
D733,465 S \* 7/2015 Parisi ..... D6/656  
D765,450 S \* 9/2016 Biddle ..... D6/691  
D781,086 S \* 3/2017 Velez ..... D6/691  
D794,982 S 8/2017 Palma  
D817,036 S 5/2018 Palma  
D833,182 S \* 11/2018 Yamamoto ..... D6/656.17  
D833,785 S \* 11/2018 Baylar ..... D6/691.4  
D853,161 S 7/2019 Parikh  
D880,879 S \* 4/2020 Kirn ..... D6/349  
D882,996 S 5/2020 Hale

OTHER PUBLICATIONS

Coco Table by Bielefelder Werkstaetten, first available: unknown. Architonic.com [online], [site visited Nov. 26, 2021], Internet URL: <https://www.architonic.com/en/product/bielefelder-werkstaetten-coco-table/20061164> (Year: 2021).\*

Natural Wood Dining Table by Leanne Ford, first available: unknown, crateandbarrel.com [online], [site visited Nov. 26, 2021], Internet URL: <https://www.crateandbarrel.com/van-natural-wood-dining-table-by-leanne-ford/s501526> (Year: 2021).\*

Solid Wood Dining Table by Studio McGee, first available: Jul. 30, 2021. Target.com [online], [site visited Nov. 26, 2021], Internet URL: <https://www.target.com/p/bell-canyon-solid-wood-dining-table-threshold-designed-with-studio-mcgee/-/A-82117639> (Year: 2021).\*

Reclaimed Elm Dining Table by Blue Hand Home, first available: Unknown. Bluehandhome.com [online], [site visited Nov. 26, 2021], Internet URL: <https://www.bluehandhome.com/products/reclaimed-elm-2-leg-plank-table-84> (Year: 2021).\*

Anton Dining Table by West Elm, first available: Sep. 15, 2019. Instagram.com [online], [site visited Dec. 3, 2021], Internet URL: [https://www.instagram.com/p/B2c2SOLjVO2/?utm\\_medium=copy\\_link](https://www.instagram.com/p/B2c2SOLjVO2/?utm_medium=copy_link) (Year: 2019).\*

Anton Dining Table by West Elm, first available: Oct. 22, 2019. Instagram.com [online], [site visited Dec. 3, 2021], Internet URL: [https://www.instagram.com/p/B2c2SOLjVO2/?utm\\_medium=copy\\_link](https://www.instagram.com/p/B2c2SOLjVO2/?utm_medium=copy_link) (Year: 2019).\*

Real Solid Wood Handcrafted Oak Dining Table by Woodironfurniturecpm, first available: Unknown. Etsy.com [online], [site visited May 23, 2022], Internet URL: <https://www.etsy.com/listing/893012986/real-solid-wood-handcrafted-oak-dining> (Year: 2022).\*

Cayman Extending Dining Table by Pottery Barn, first available: DFA Unknown. Potterybarn.com [online], [site visited May 23, 2022], Internet URL: <https://www.potterybarn.com/products/cayman-extending-dining-table/> (Year: 2022).\*

\* cited by examiner

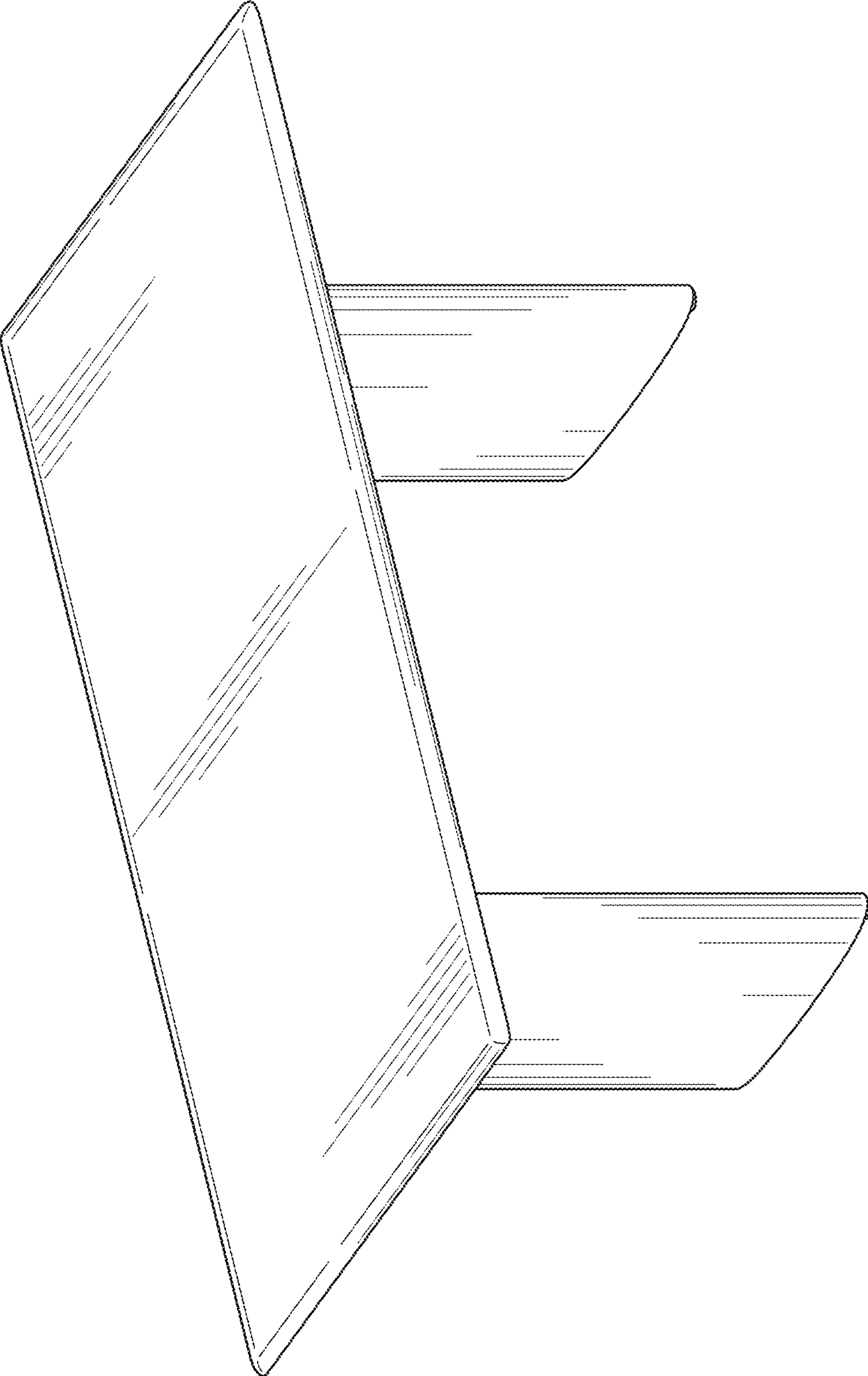

FIG. 1

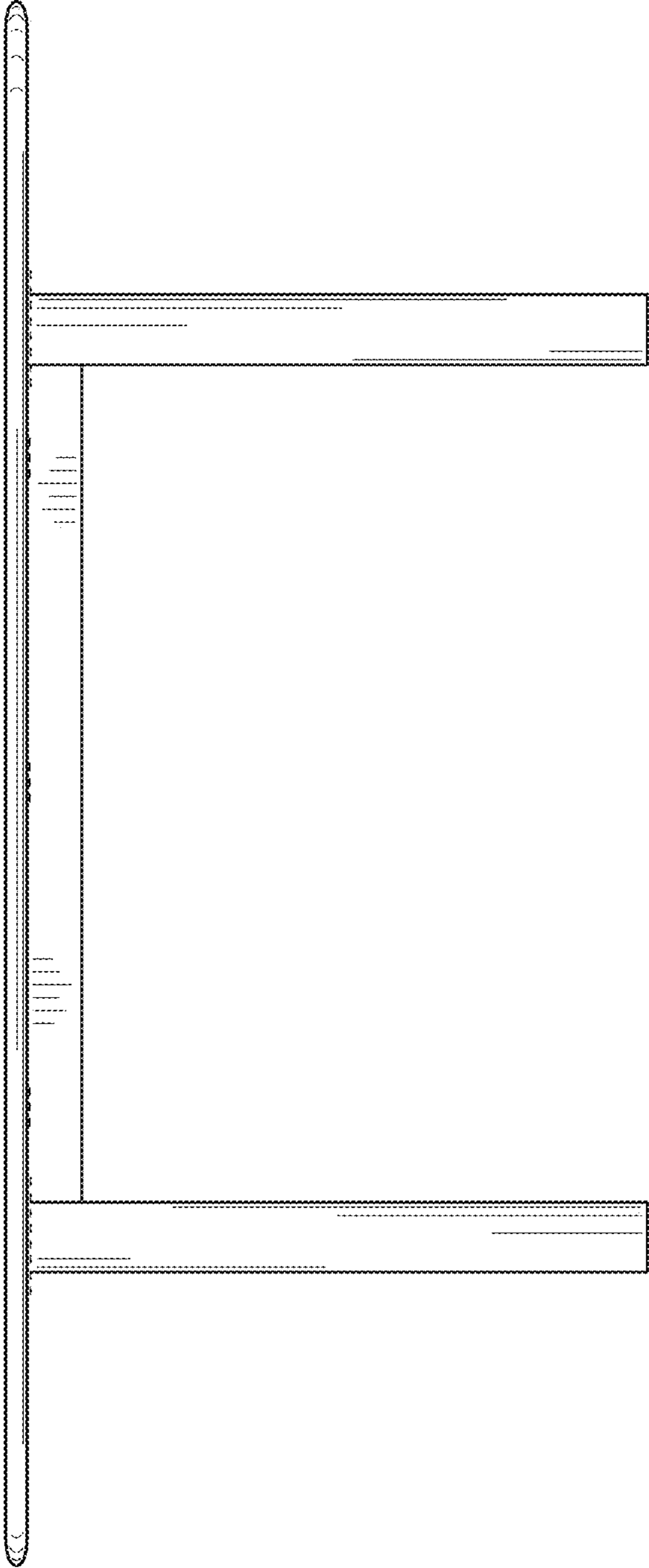

FIG. 2

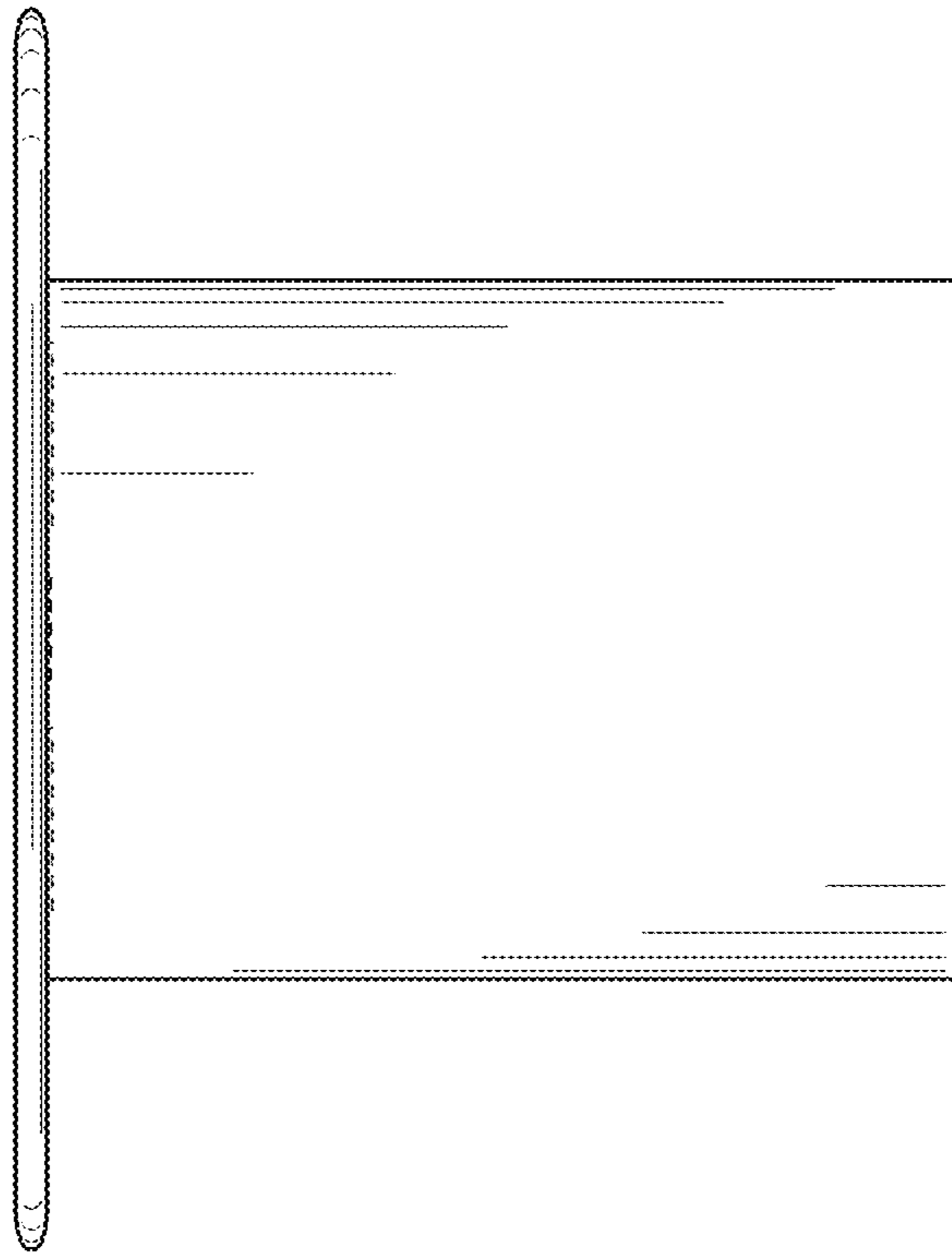

FIG. 3

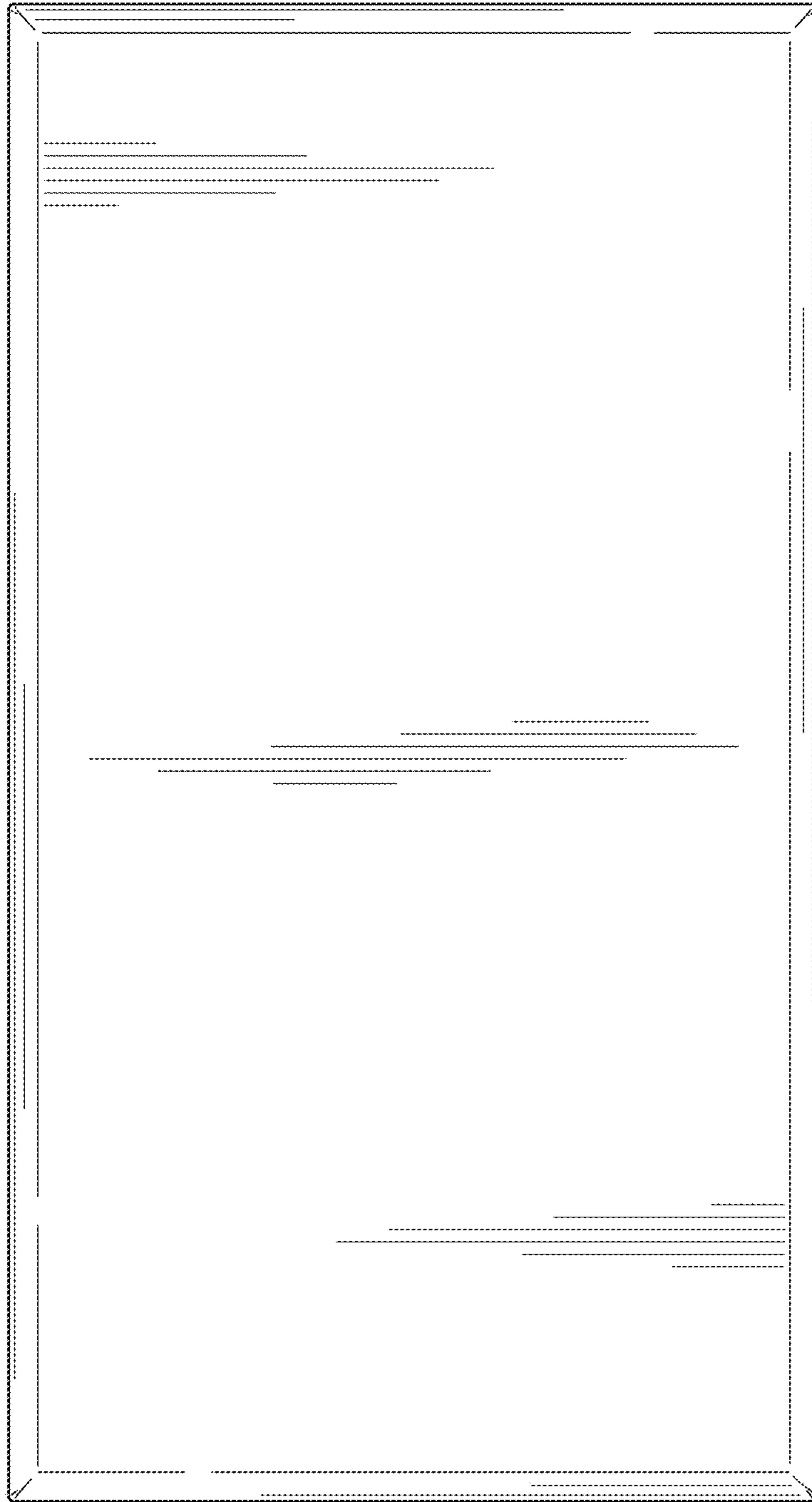

FIG. 4

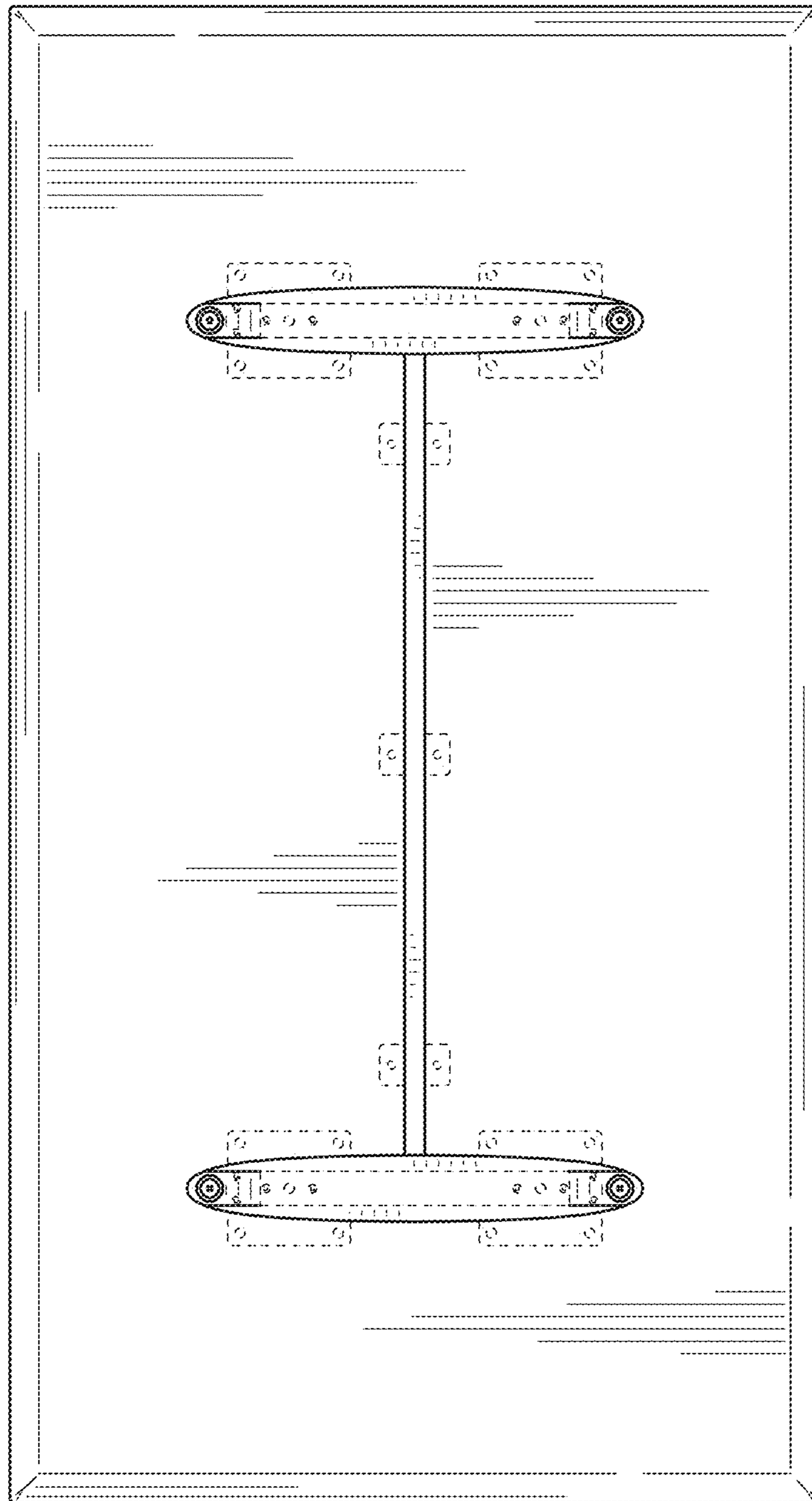

FIG. 5

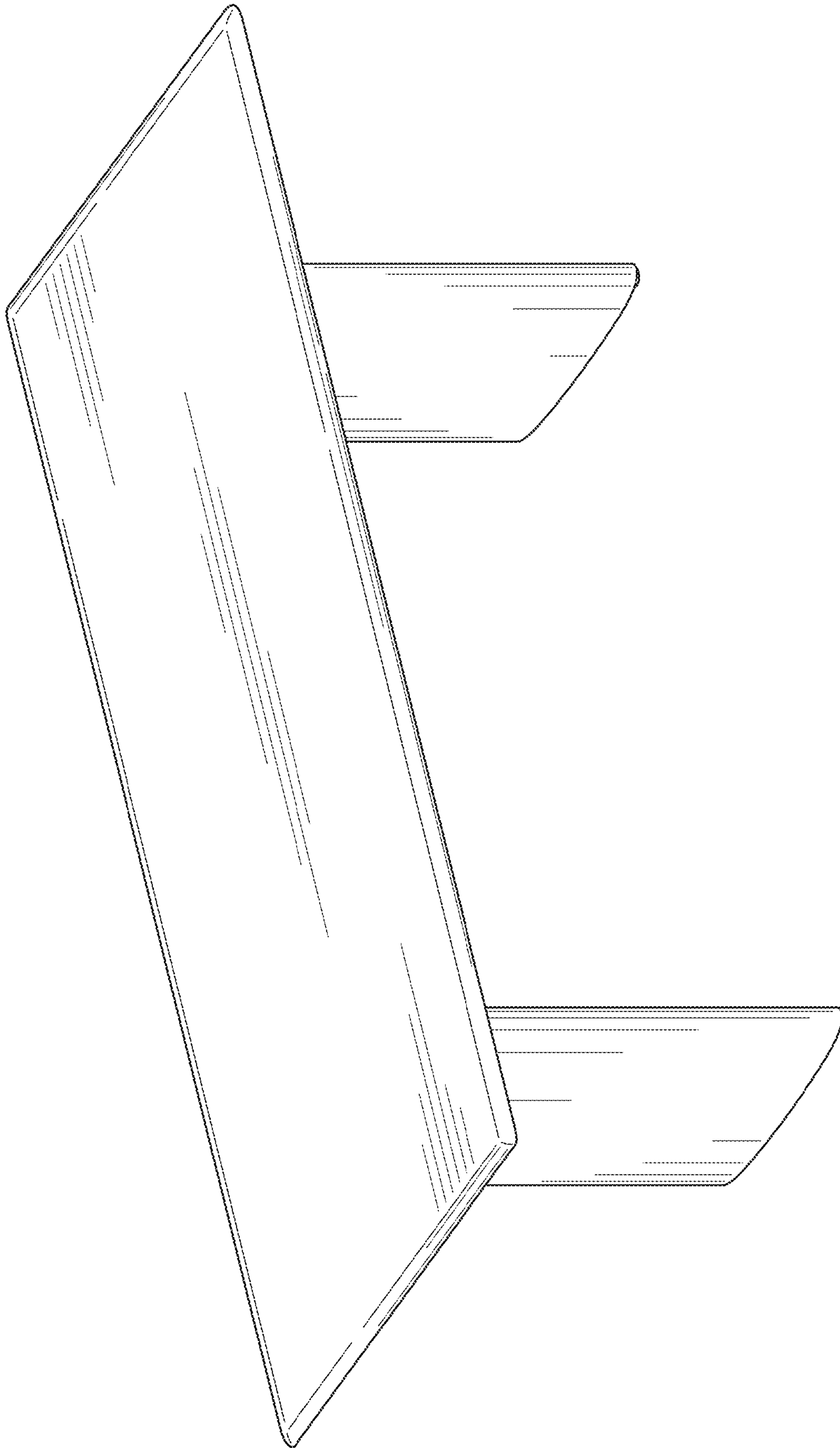

FIG. 6



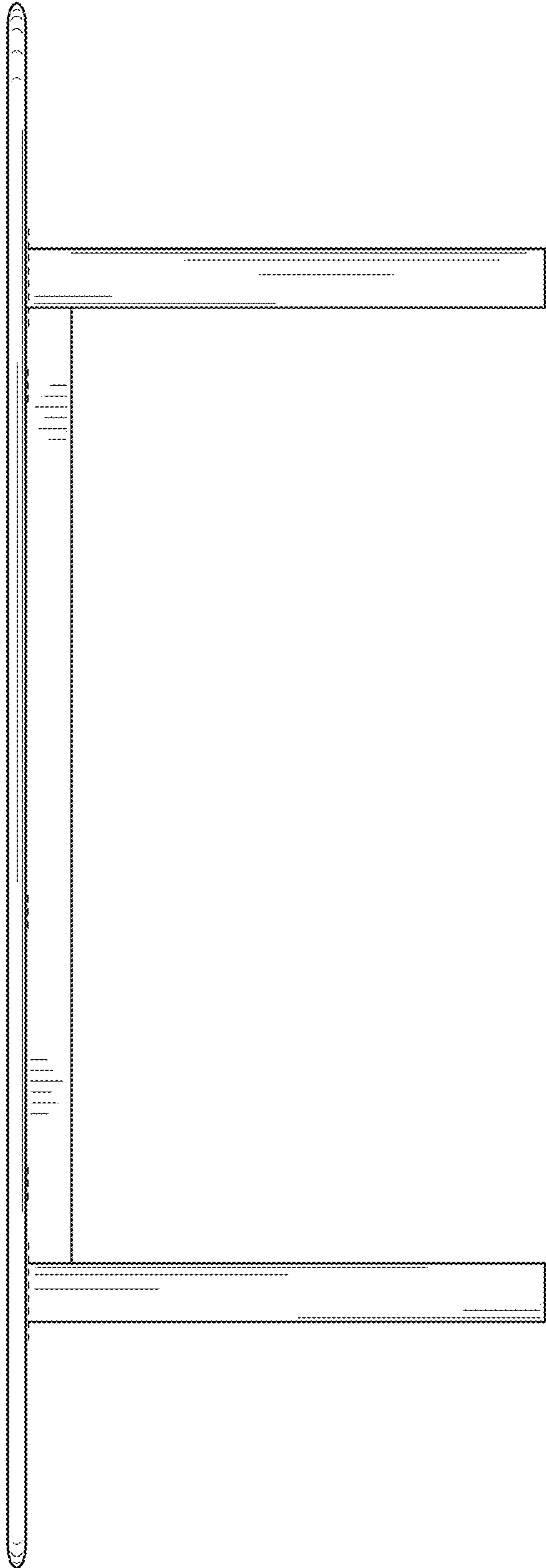

FIG. 7

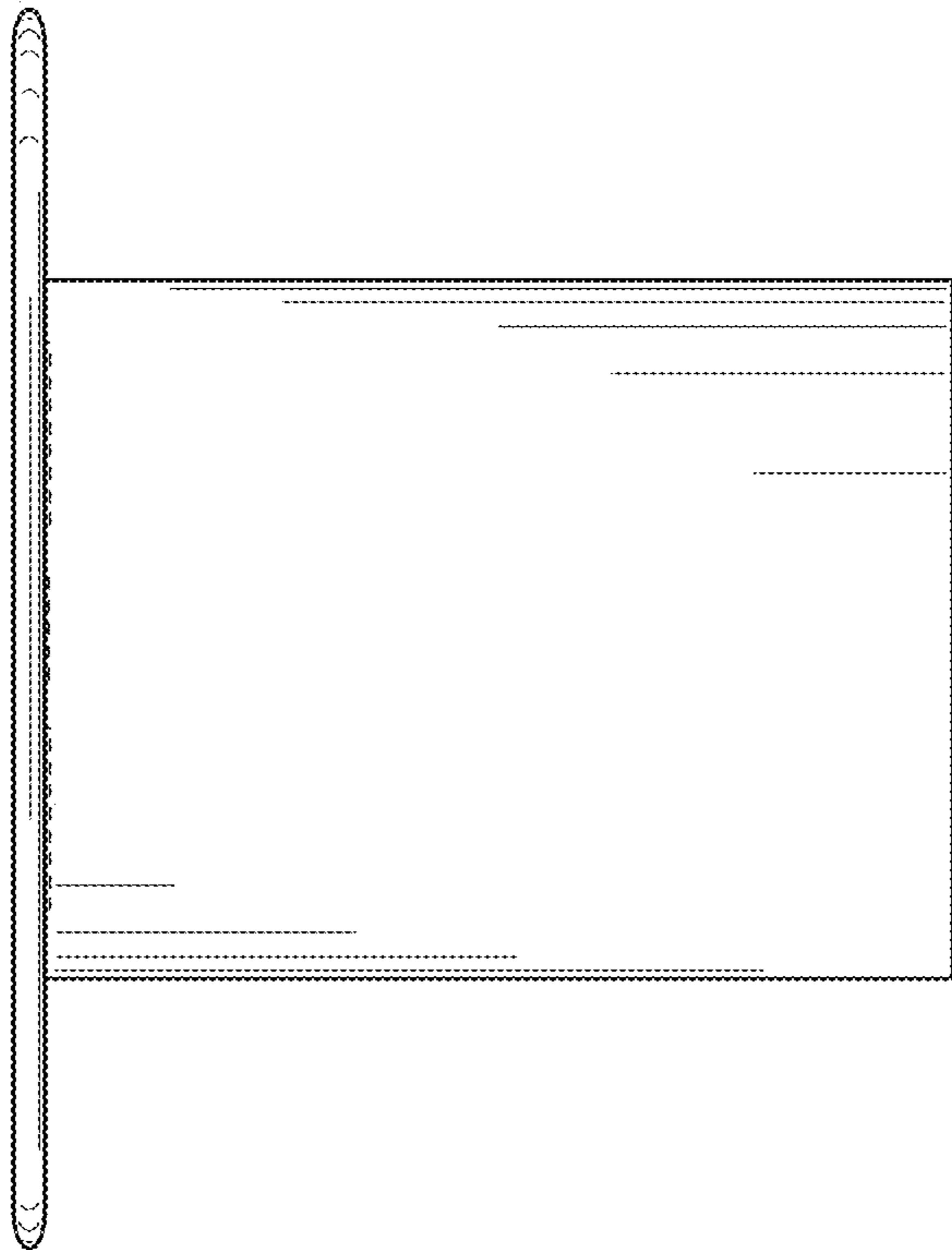

FIG. 8

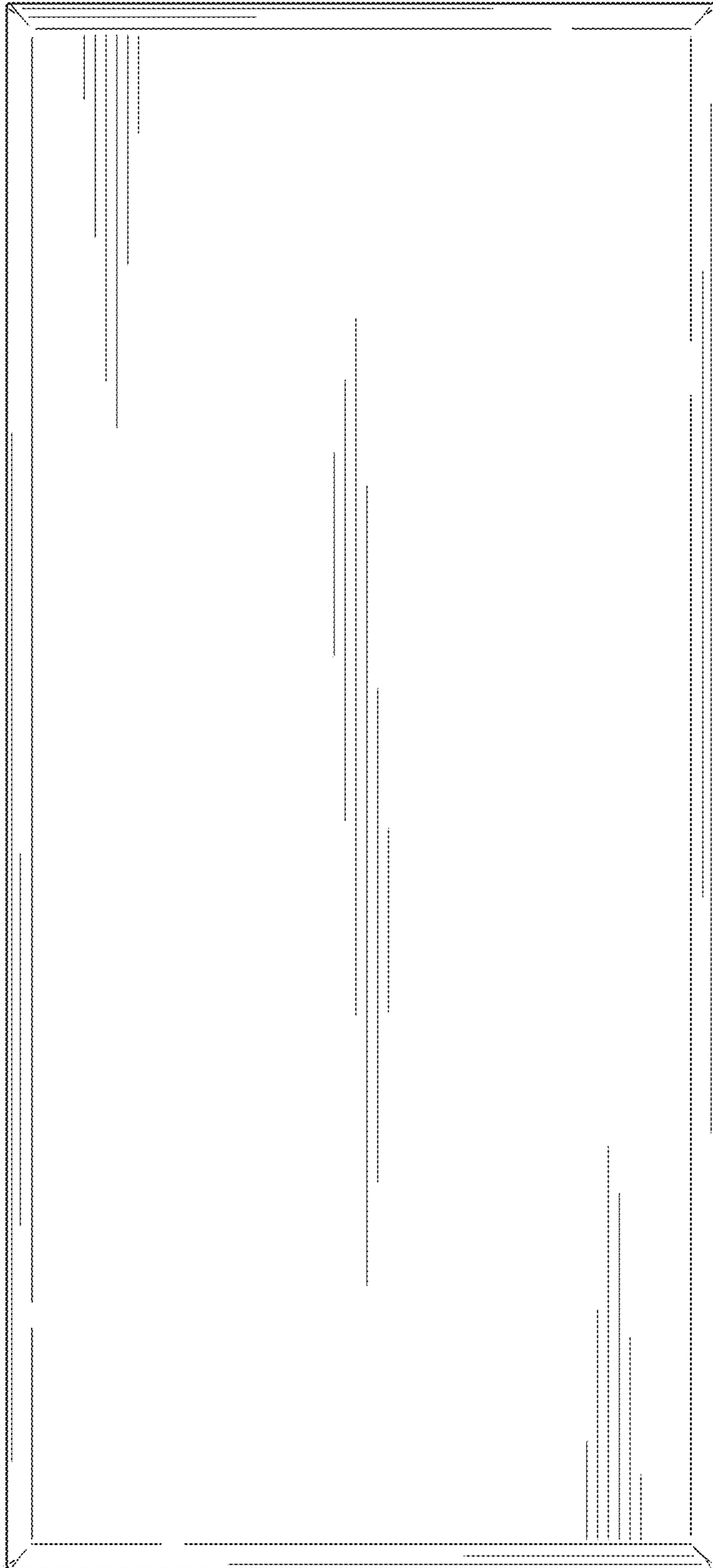

FIG. 9

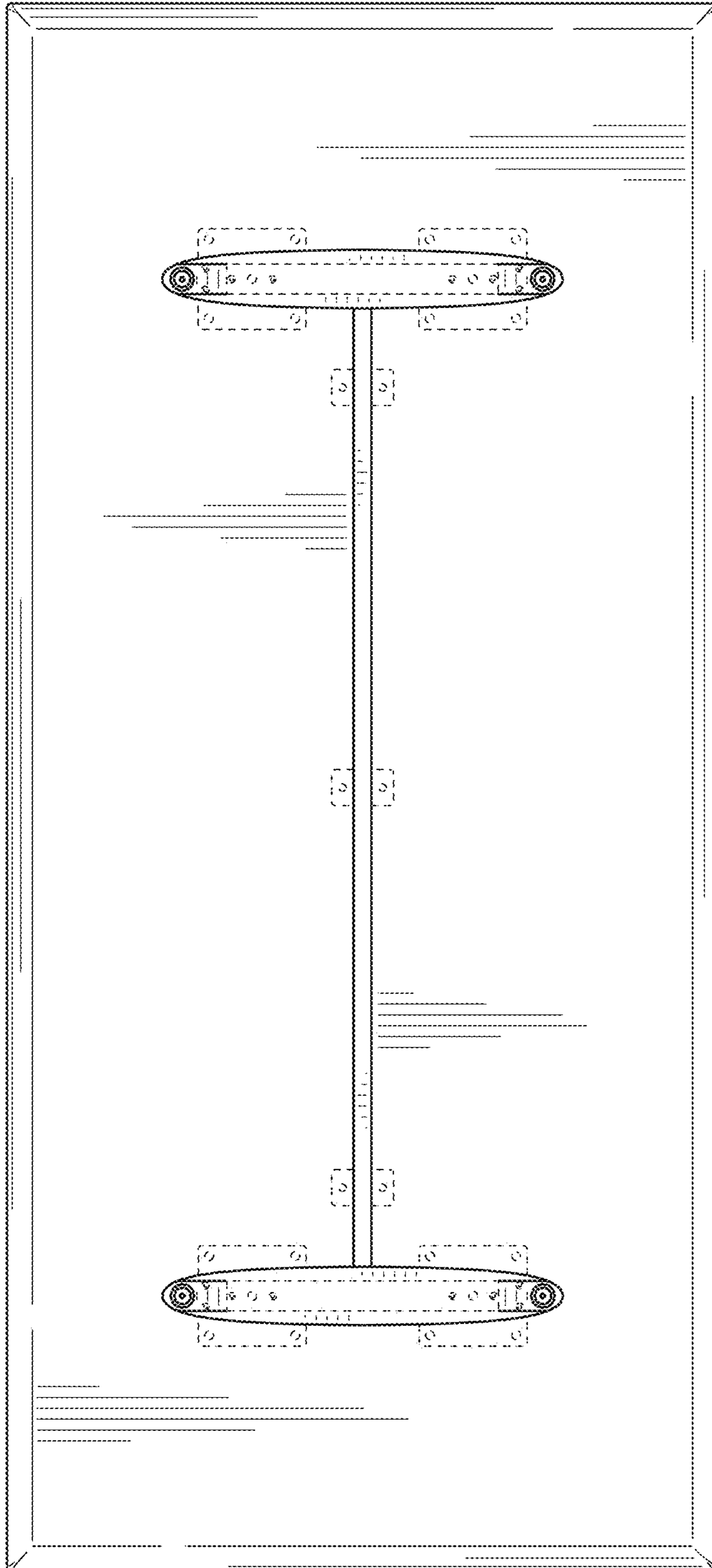

FIG. 10