



US00D958554S

(12) **United States Design Patent**
Matheson

(10) **Patent No.:** **US D958,554 S**

(45) **Date of Patent:** **** Jul. 26, 2022**

(54) **HUNTING SEAT**

(71) Applicant: **Scott Matheson**, Plymouth, WI (US)

(72) Inventor: **Scott Matheson**, Plymouth, WI (US)

(**) Term: **15 Years**

(21) Appl. No.: **29/818,797**

(22) Filed: **Dec. 10, 2021**

(51) **LOC (13) Cl.** **06-01**

(52) **U.S. Cl.**
USPC **D6/349; D6/601**

(58) **Field of Classification Search**
USPC D6/334, 335, 344, 348, 349–353,
D6/364–365, 691–691.9, 692–692.6, 694,
D6/698, 700, 707.2, 708, 708.17, 708.25,
D6/716–716.1, 716.11; D25/65
CPC ... A47C 12/00; A47C 13/00; A47C 16/02–04;
A47K 17/02; A47K 17/028
See application file for complete search history.

(56) **References Cited**

U.S. PATENT DOCUMENTS

- 3,323,151 A * 6/1967 Lerman A47C 7/021
297/382
- 4,208,070 A * 6/1980 Geschwender A47C 3/04
297/229
- D328,001 S * 7/1992 Kelly D6/707
- D330,978 S * 11/1992 Vasquez D6/601
- D372,829 S * 8/1996 Sirey D6/601
- 5,572,758 A * 11/1996 Merritt A47C 7/021
5/907
- D428,720 S * 8/2000 Rutherford D6/716.1
- D444,918 S * 7/2001 Suter D29/100
- D462,862 S * 9/2002 Thayer, Jr. D6/601
- D601,844 S * 10/2009 Miller D6/611
- D634,951 S * 3/2011 Dreiling D6/716.1
- D697,739 S * 1/2014 Nabeta D6/601
- 8,910,330 B1 * 12/2014 Malik A47G 9/109
5/636

- D725,923 S * 4/2015 Kaye D6/349
- D725,924 S * 4/2015 Kaye D6/349
- D823,025 S * 7/2018 Dennehy D6/601
- D845,673 S * 4/2019 Dennehy D6/601
- D911,656 S * 2/2021 Baker D34/27
- D951,677 S * 5/2022 Cohen D6/601
- 2003/0101514 A1 * 6/2003 Roberson A47C 16/04
5/632
- 2007/0000005 A1 * 1/2007 Wang A41D 13/065
2/24
- 2007/0001503 A1 * 1/2007 Brady A47B 95/043
297/423.4

(Continued)

OTHER PUBLICATIONS

Allen—Vanish Foam Cushion—Olive, [online] Retrieved Jun. 1, 2022 from URL: <https://www.murdochs.com/products/sporting-goods/hunting-shooting-equipment/shooting-range/shooting-stools/allen-vanish-foam-cushion/> (Year: 2022).*

(Continued)

Primary Examiner — Vy N Koenig

(74) *Attorney, Agent, or Firm* — Donald J. Ersler

(57) **CLAIM**

The ornamental design for a hunting seat, as shown and described.

DESCRIPTION

FIG. 1 is a top perspective view of the hunting seat incorporating my new design;
FIG. 2 is a bottom perspective view thereof;
FIG. 3 is a top plan view thereof;
FIG. 4 is a bottom plan view thereof;
FIG. 5 is a left side view thereof;
FIG. 6 is a front view thereof; and,
FIG. 7 is a rear view thereof.
The broken lines illustrate portions of the hunting seat that form no part of the claimed design.

1 Claim, 3 Drawing Sheets

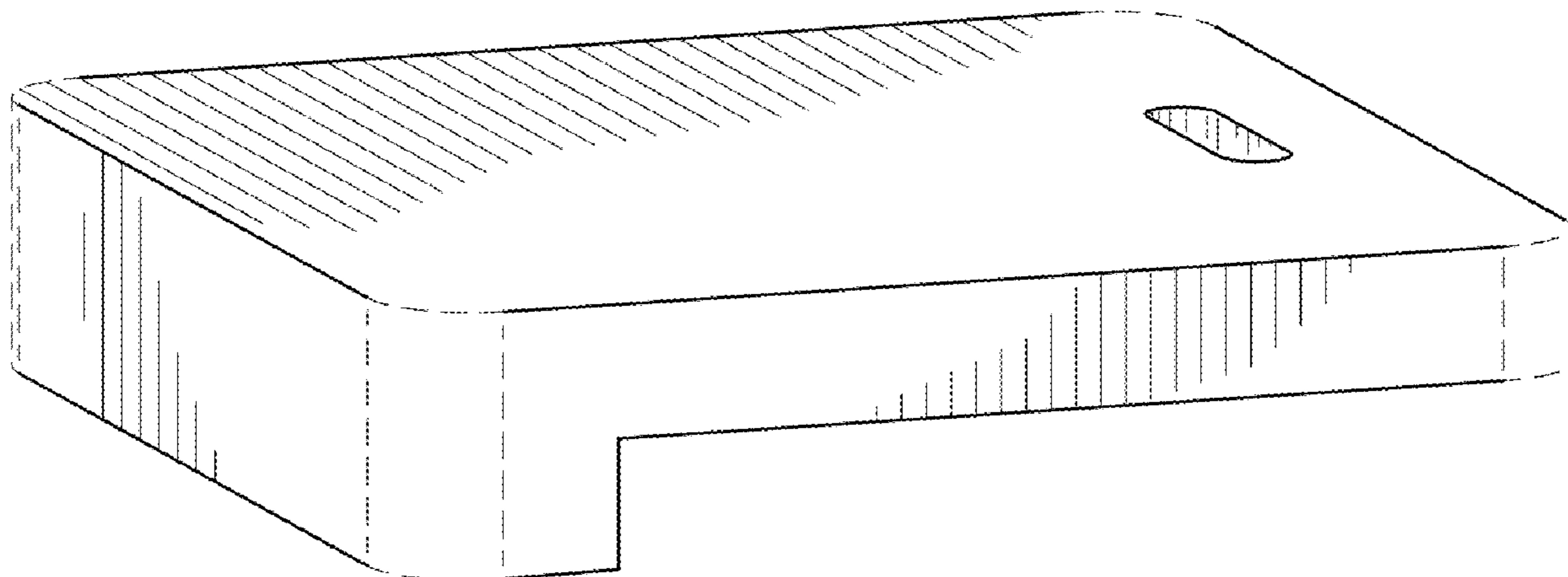

(56)

References Cited

U.S. PATENT DOCUMENTS

2017/0320551 A1* 11/2017 Dennehy A47C 7/18
2020/0190894 A1* 6/2020 Gunawardena A47L 13/00
2021/0244584 A1* 8/2021 Masters A47K 17/028

OTHER PUBLICATIONS

XCEL Portable Stadium Bleacher Seat Pad Cushion Multipack . . .
[online] First available on Amazon Oct. 31, 2019. Retrieved from
URL: <https://www.amazon.com/XCEL-Portable-Stadium-Bleacher-Multipack/dp/B07ZQQ8KWT?th=1&psc=1> (Year: 2019).*

* cited by examiner

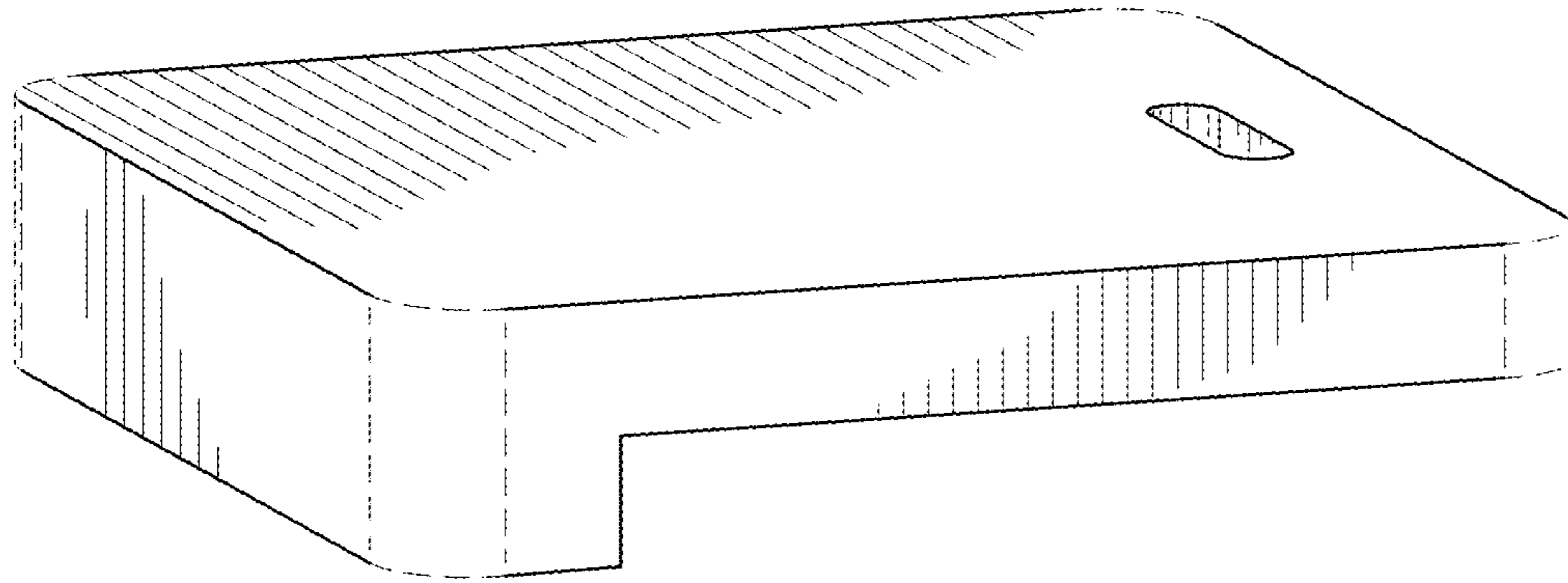

FIG. 1

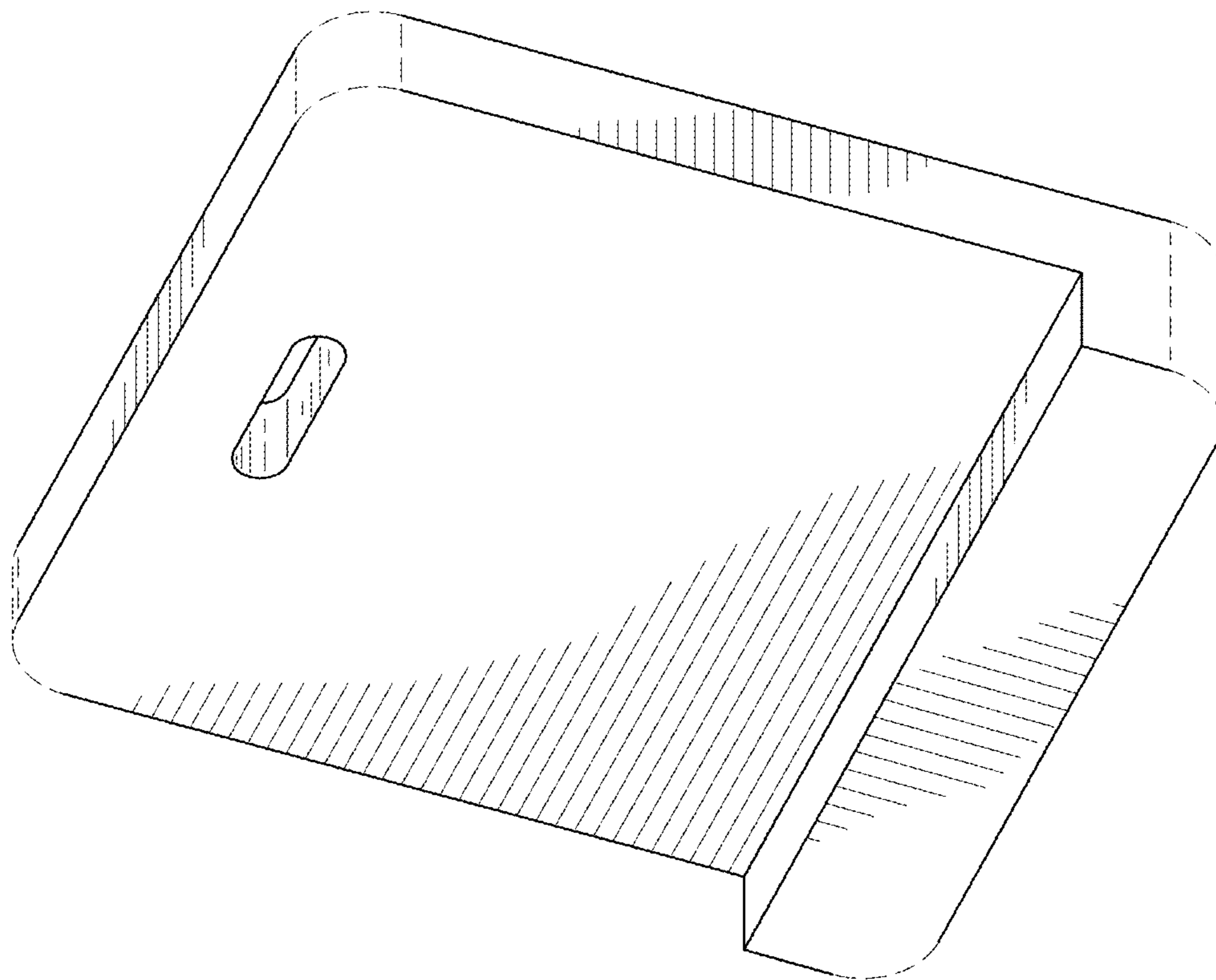

FIG. 2

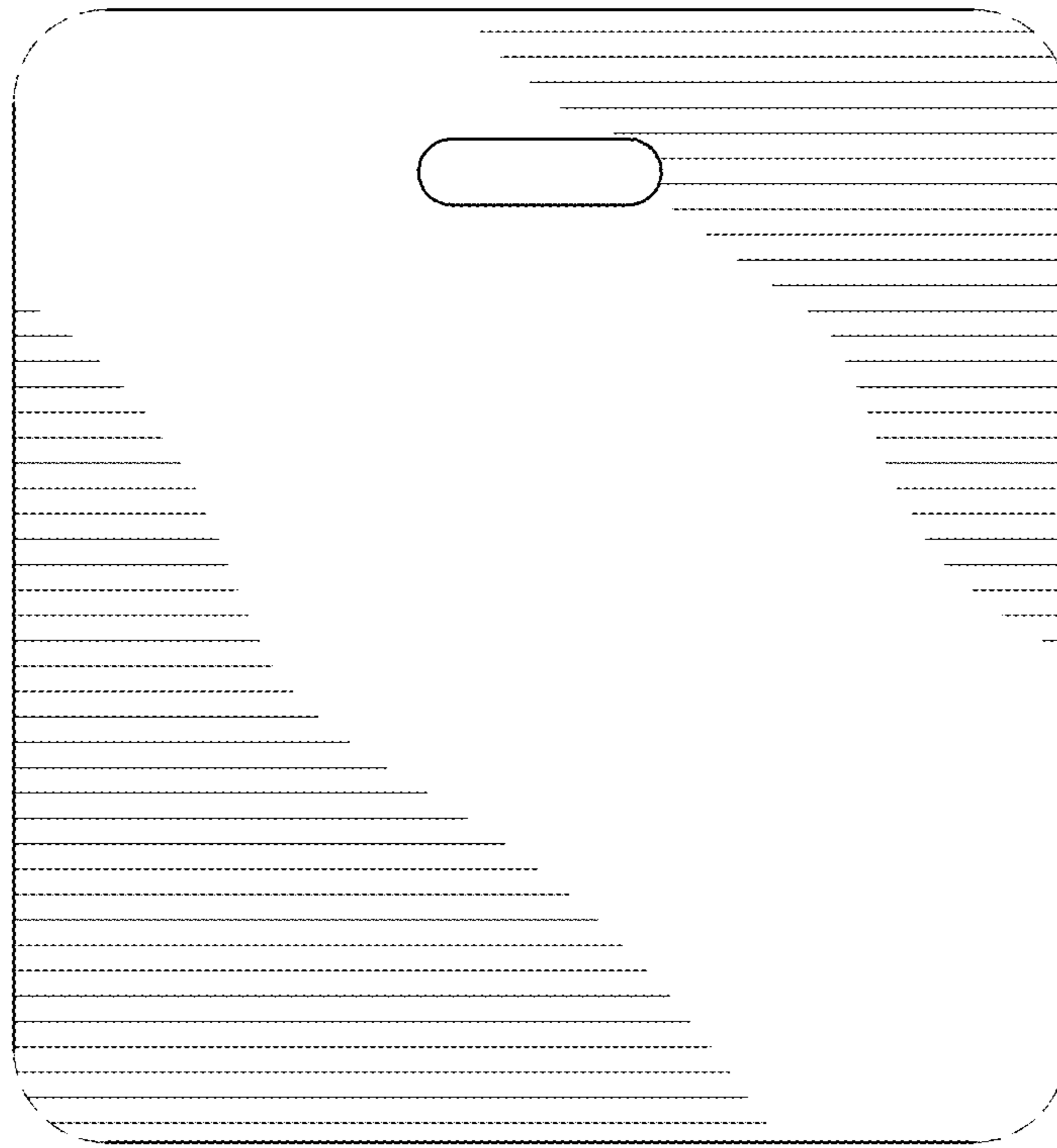

FIG. 3

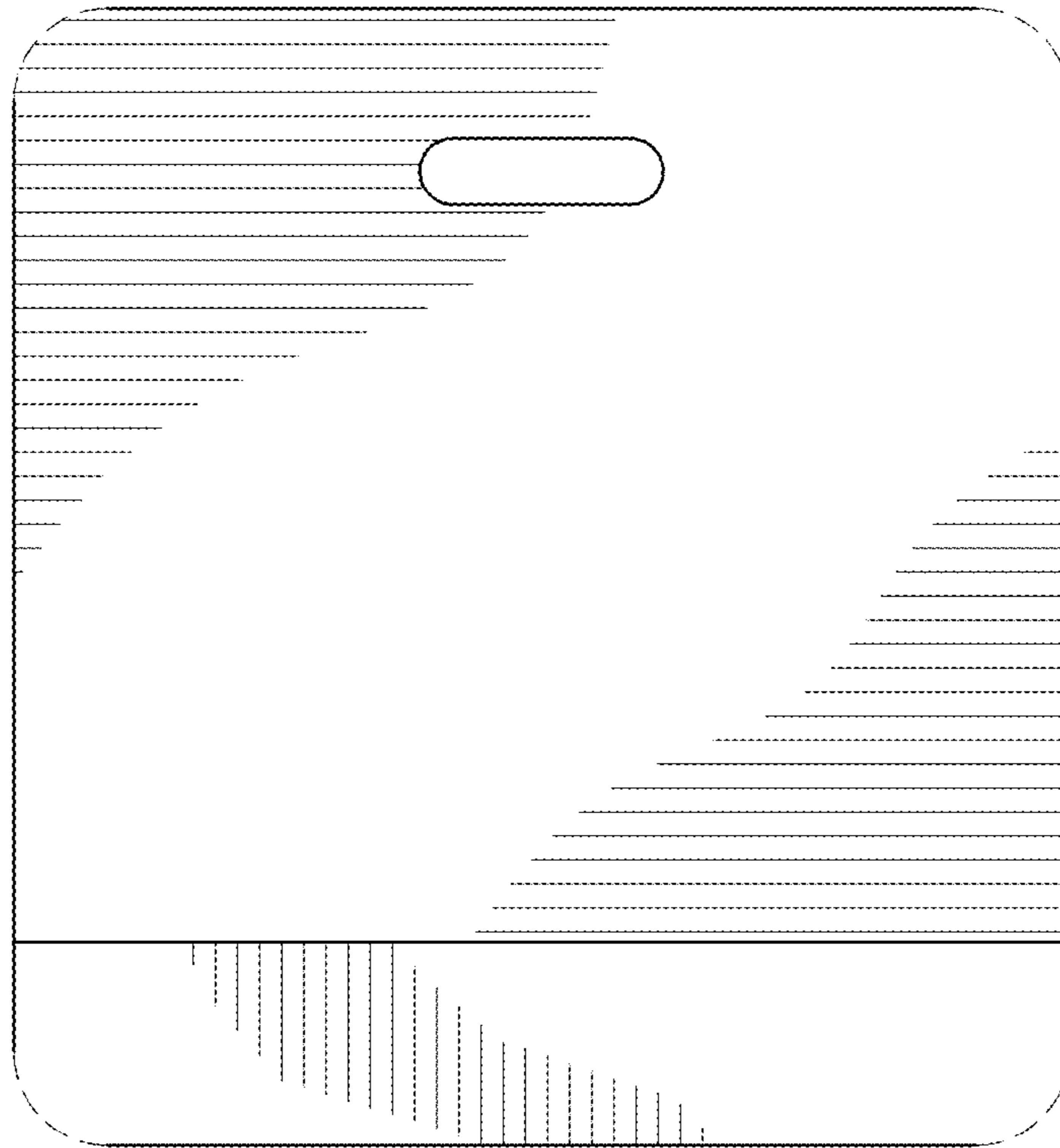

FIG. 4

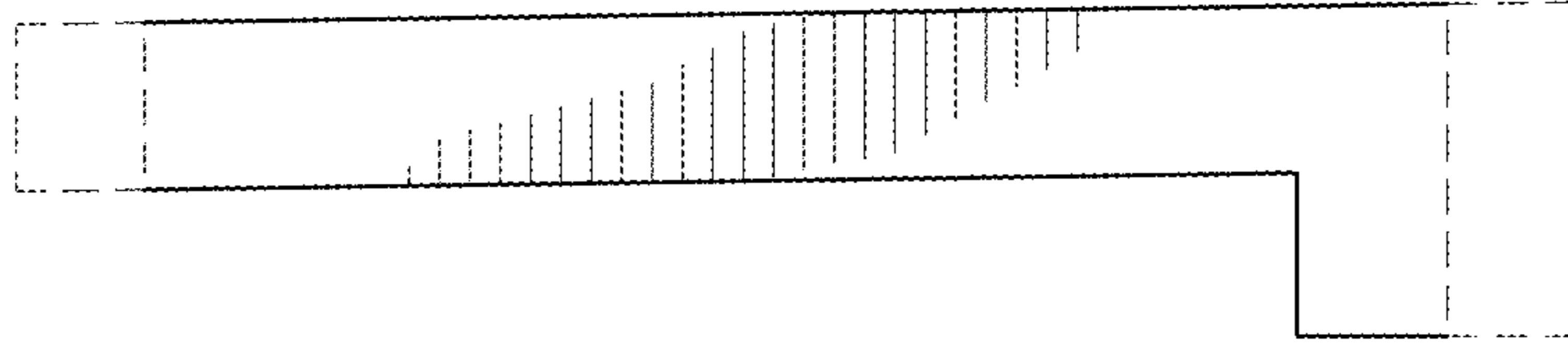

FIG. 5

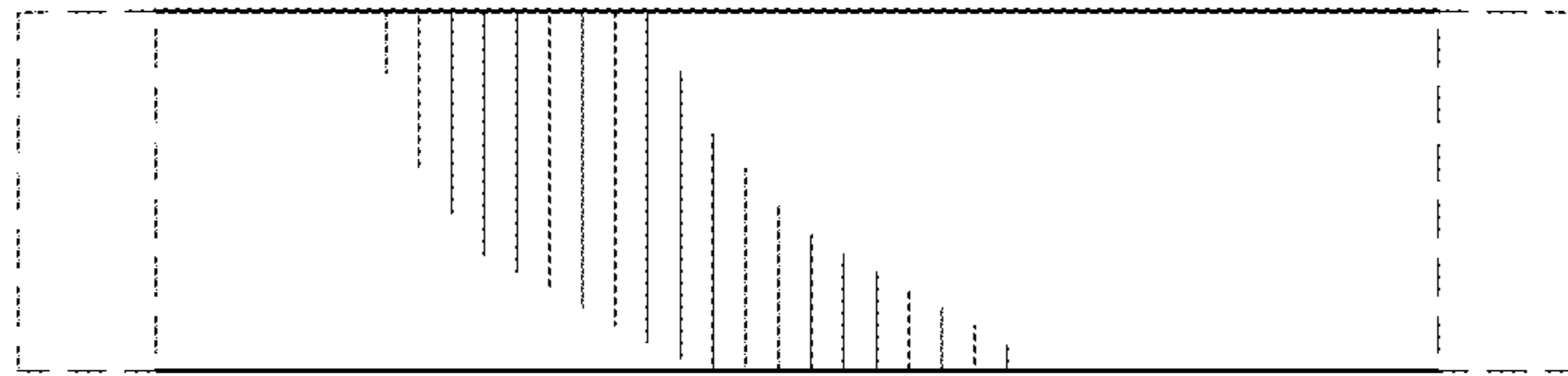

FIG. 6

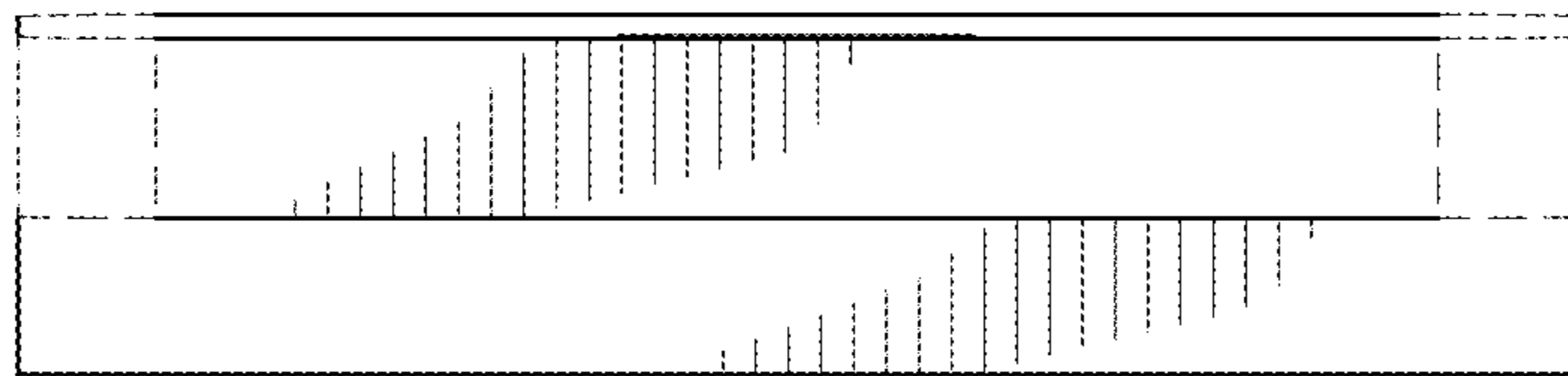

FIG. 7