



US00D958532S

(12) **United States Design Patent**
Ekman et al.

(10) **Patent No.:** **US D958,532 S**
(45) **Date of Patent:** **** Jul. 26, 2022**

(54) **CASE**

- (71) Applicant: **Apple Inc.**, Cupertino, CA (US)
- (72) Inventors: **Kjell Ferdinand Ekman**, Los Angeles, CA (US); **Christina J. Smiechowski**, West Hollywood, CA (US); **Duy P. Le**, Los Angeles, CA (US); **Jeffrey Scott Croyle**, San Francisco, CA (US); **Matthew Phillip Casebolt**, Fremont, CA (US); **Matthew Vincent Costello**, Soquel, CA (US); **James Swasey**, Oakland, CA (US); **Guillaume Raoult**, San Francisco, CA (US); **Christopher Kuh**, San Francisco, CA (US); **Robert Brunner**, Glen Ellen, CA (US)
- (73) Assignee: **Apple Inc.**, Cupertino, CA (US)

(**) Term: **15 Years**

(21) Appl. No.: **29/763,657**

(22) Filed: **Dec. 23, 2020**

(51) **LOC (13) Cl.** **03-01**

(52) **U.S. Cl.**
USPC **D3/294**

(58) **Field of Classification Search**
USPC D3/201, 207, 208, 211, 212, 274, 276,
D3/294; D9/504, 549

(Continued)

(56) **References Cited**

U.S. PATENT DOCUMENTS

- D806,388 S 1/2018 Akana et al.
 - D826,852 S * 8/2018 Hung D13/108
- (Continued)

FOREIGN PATENT DOCUMENTS

- CN 305127668 * 4/2019
- JP D1667775 * 9/2020
- RU 00122317 * 3/2020

OTHER PUBLICATIONS

1MORE Colorbuds Wireless Earbuds, announced Jun. 24, 2020 [online] [site visited Feb. 26, 2022]. Available from internet, URL: <<https://www.amazon.com/dp/B08BRP6XN7/?th=1>> (Year: 2020).*
(Continued)

Primary Examiner — Kevin K Rudzinski
Assistant Examiner — Amber J Rabie
(74) *Attorney, Agent, or Firm* — Sterne, Kessler, Goldstein & Fox P.L.L.C.

(57) **CLAIM**

The ornamental design for a case, as shown and described.

DESCRIPTION

FIG. 1 is a top front perspective view of a case in a closed position showing the claimed design;
FIG. 2 is a top rear perspective view thereof;
FIG. 3 is a front view thereof;
FIG. 4 is a rear view thereof;
FIG. 5 is a left side view thereof;
FIG. 6 is a right side view thereof;
FIG. 7 is a top view thereof;
FIG. 8 is a bottom view thereof;
FIG. 9 is a top front perspective view thereof in an open position;
FIG. 10 is a front view thereof;
FIG. 11 is a rear view thereof;
FIG. 12 is a left side view thereof;
FIG. 13 is a right side view thereof;
FIG. 14 is a top view thereof;
FIG. 15 is a bottom view thereof; and,
FIG. 16 is a cross-sectional view thereof taken along line 16-16 in FIG. 14.
The broken lines in the figures show portions of the case that form no part of the claimed design.

1 Claim, 15 Drawing Sheets

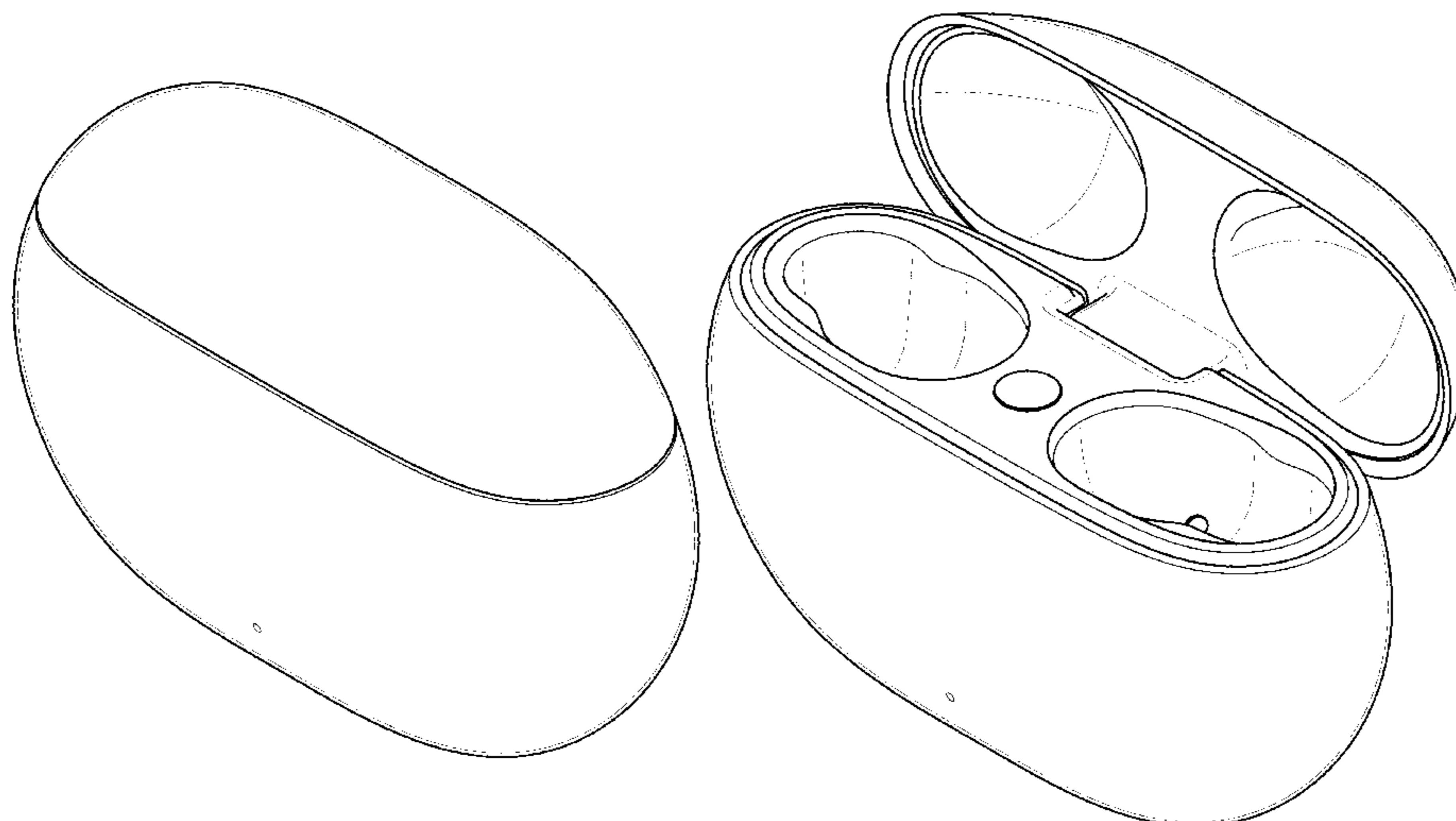

(58) **Field of Classification Search**

CPC H04R 1/1033
See application file for complete search history.

(56) **References Cited**

U.S. PATENT DOCUMENTS

D838,480 S *	1/2019	Son	D3/294
D841,581 S *	2/2019	Bonahoom	D13/108
D851,913 S *	6/2019	Yu	D3/201
D873,217 S *	1/2020	Zhang	D3/294
D881,572 S *	4/2020	Wang	D3/294
D881,810 S *	4/2020	Zhang	D13/108
D887,351 S *	6/2020	Bonahoom	D13/108
D888,664 S *	6/2020	Ma	D13/108
D893,185 S *	8/2020	Liu	D3/294
D895,582 S *	9/2020	Wu	D14/223
D902,588 S *	11/2020	Zhang	D3/294
D904,025 S *	12/2020	Ma	D3/294

OTHER PUBLICATIONS

U.S. Appl. No. 29/705,726, filed Sep. 13, 2019.

U.S. Appl. No. 29/758,168, filed Nov. 12, 2020.

* cited by examiner

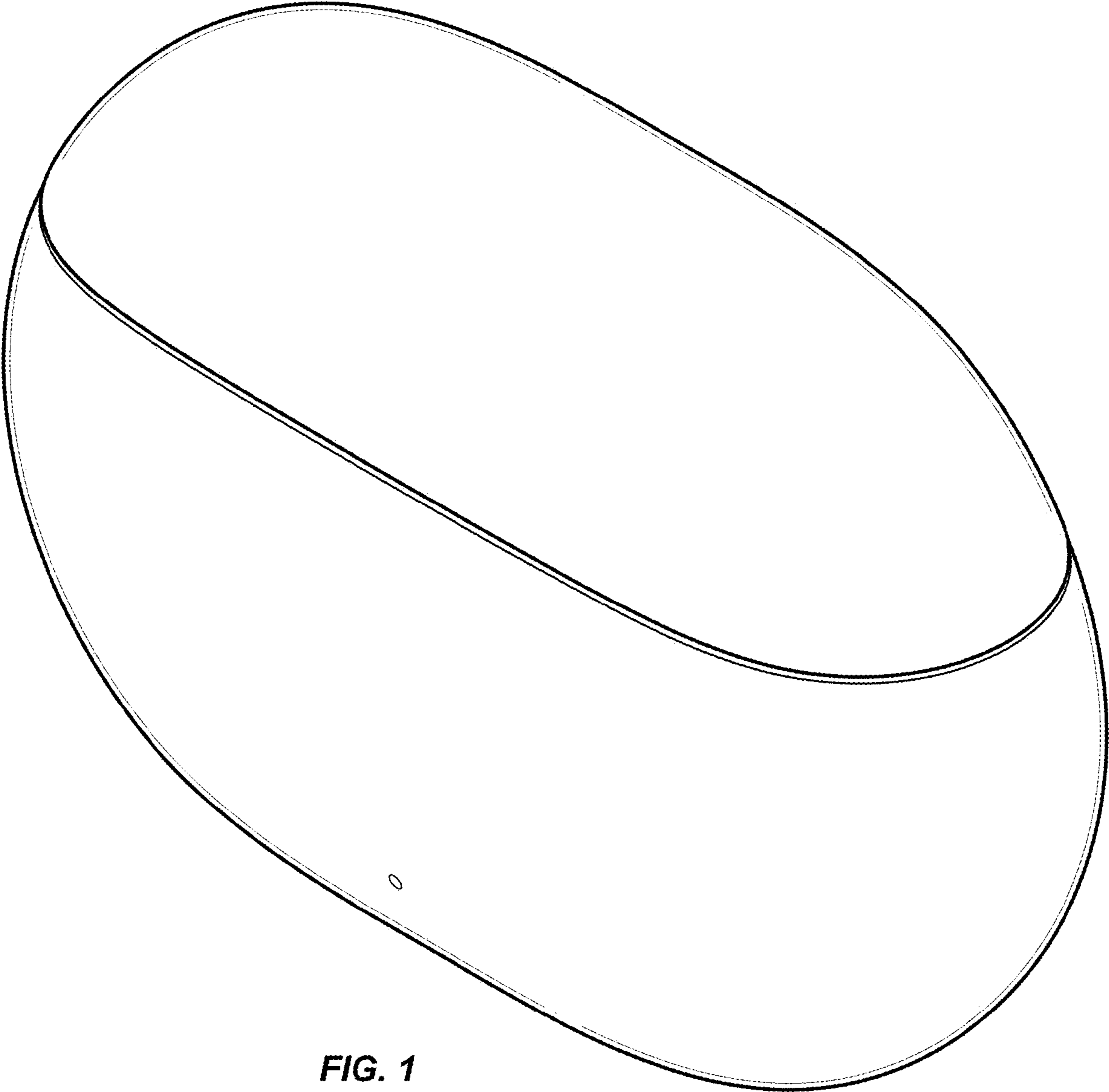

FIG. 1

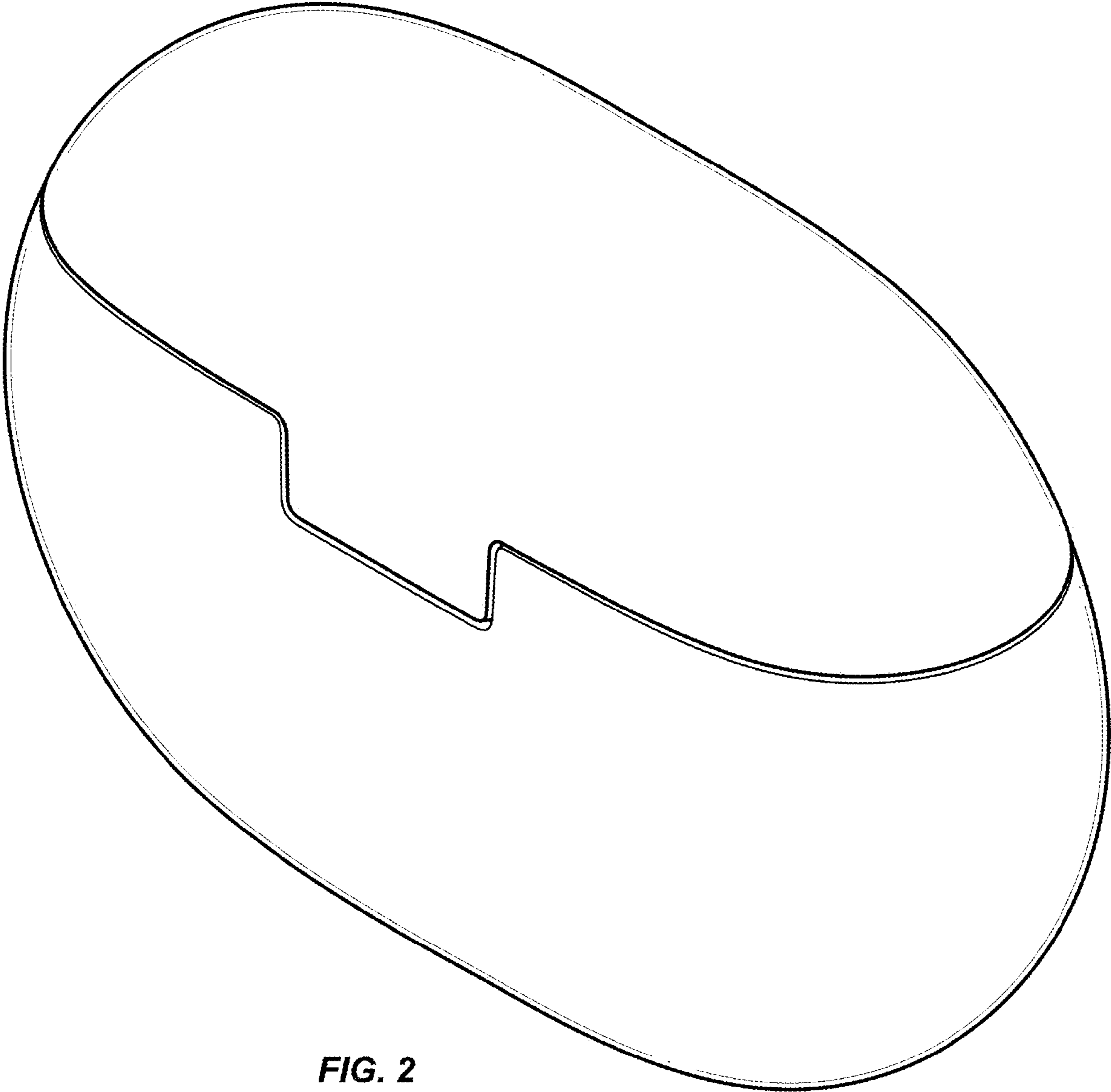

FIG. 2

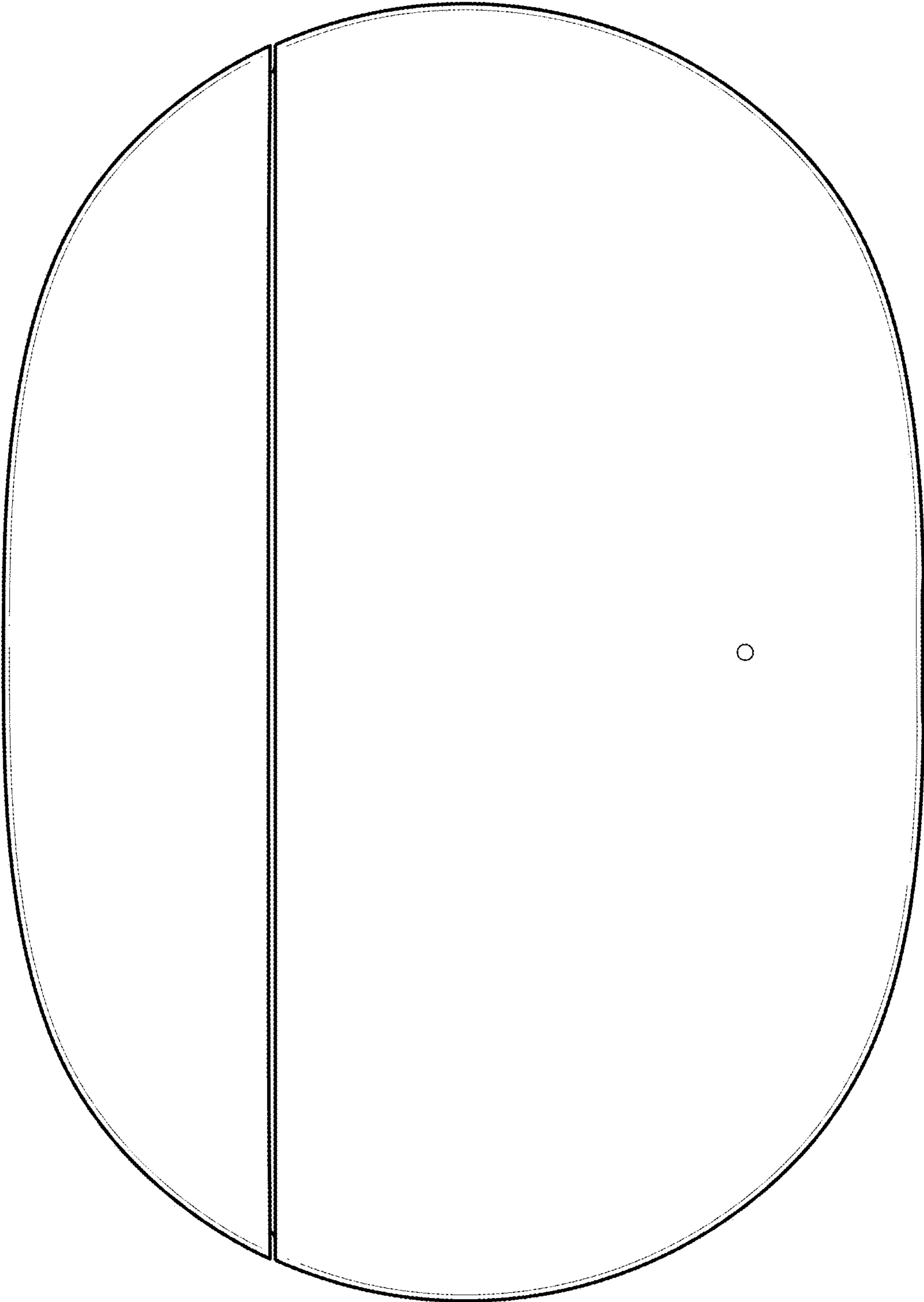

FIG. 3

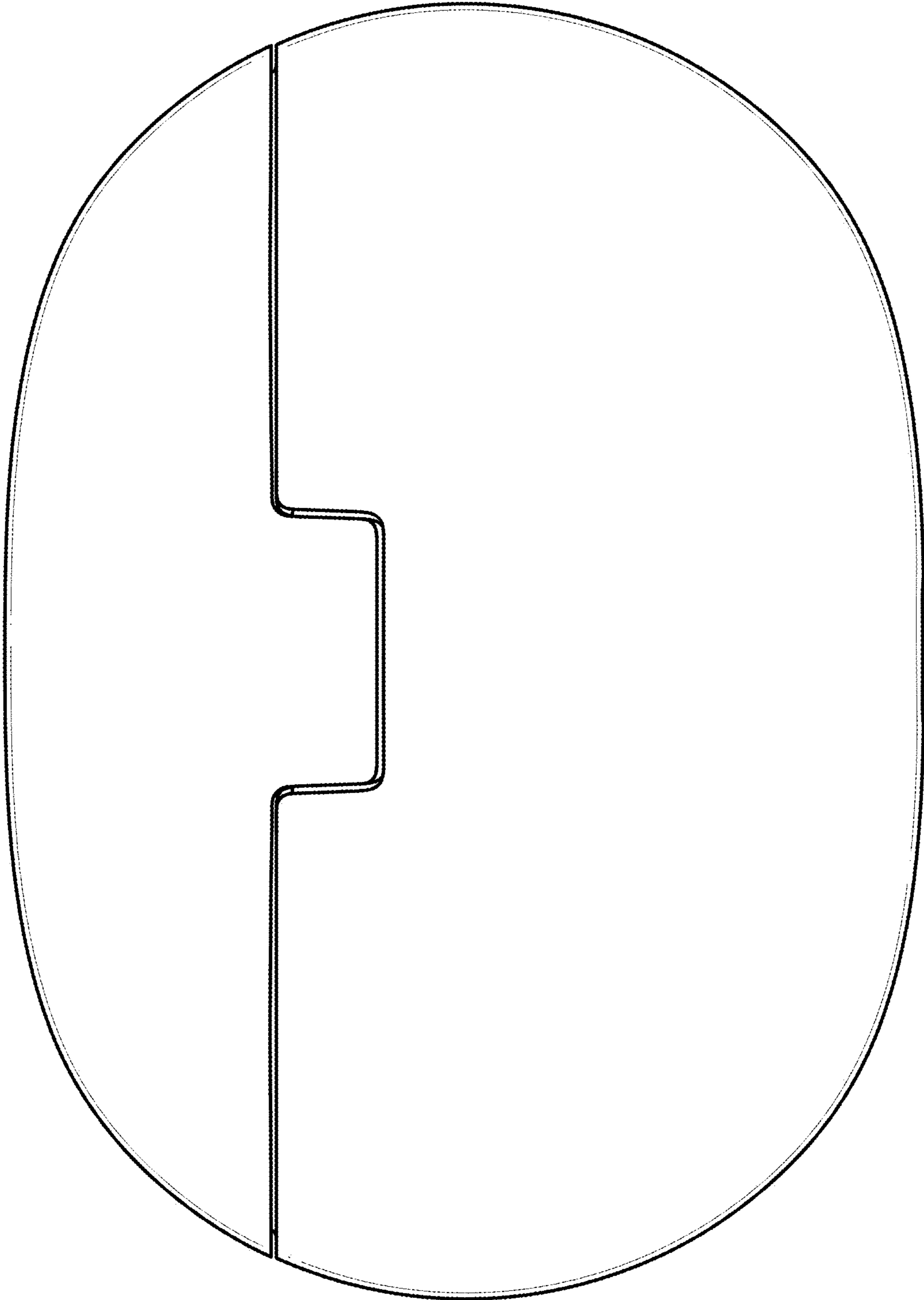

FIG. 4

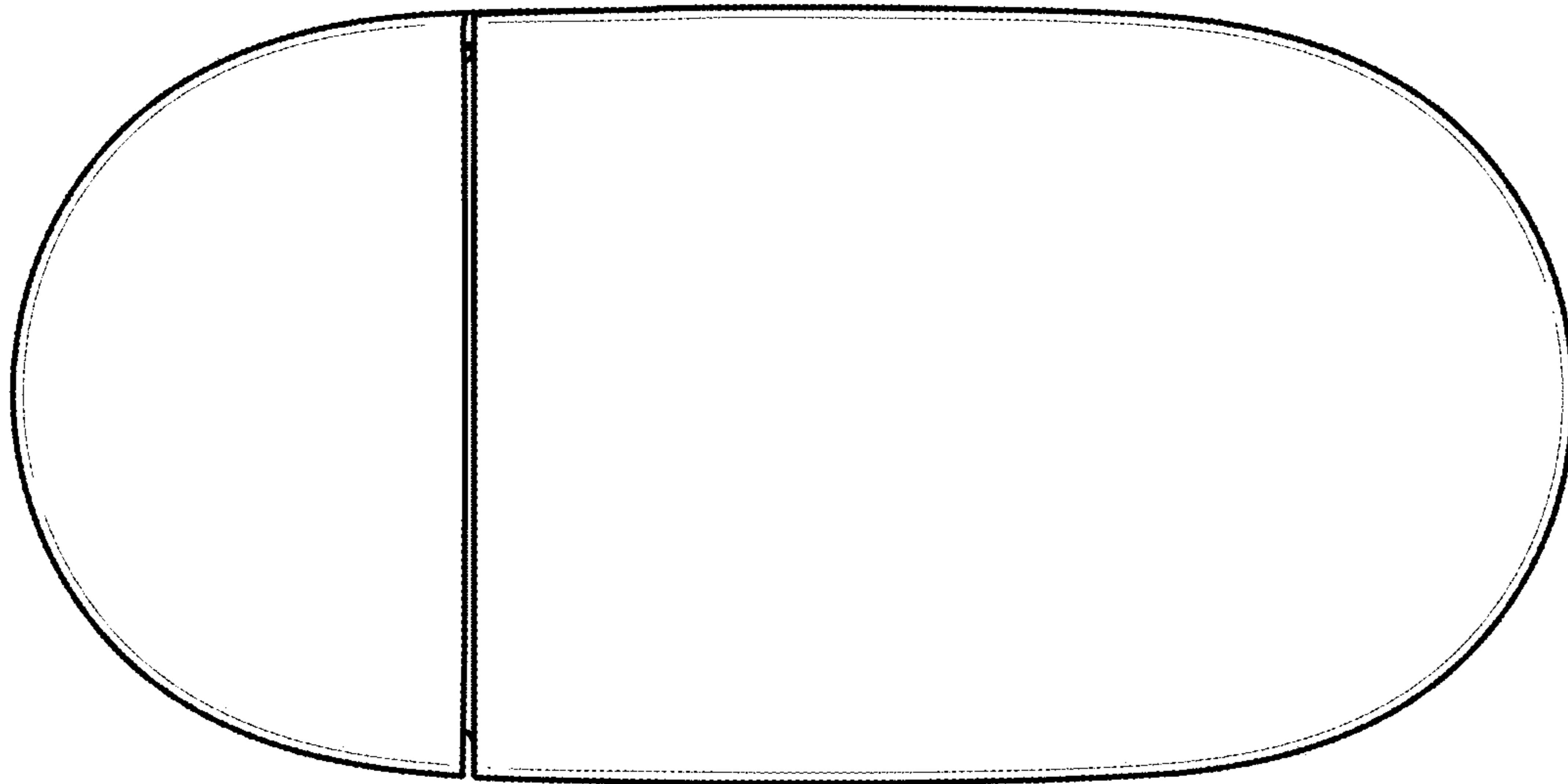

FIG. 6

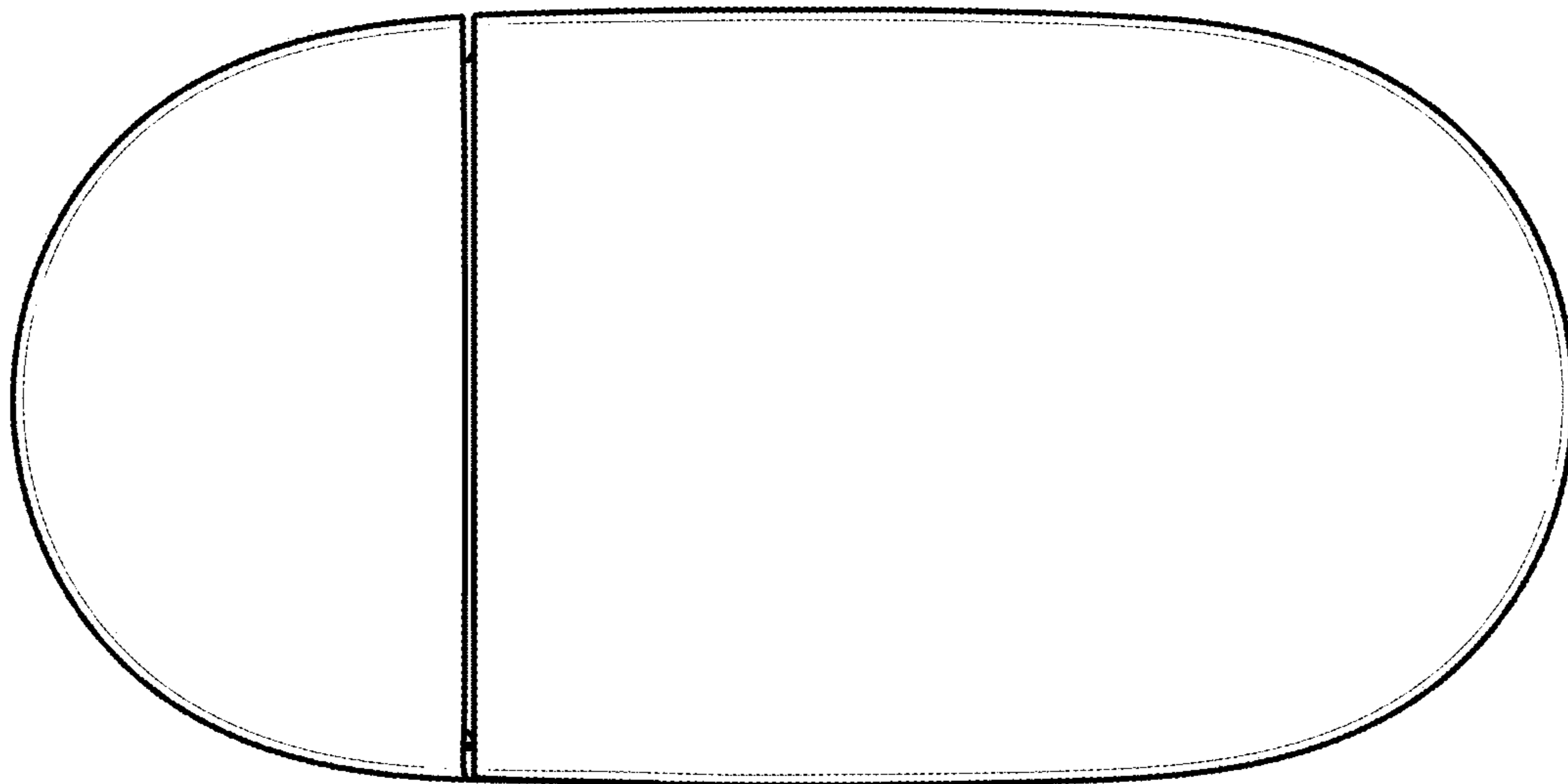

FIG. 5

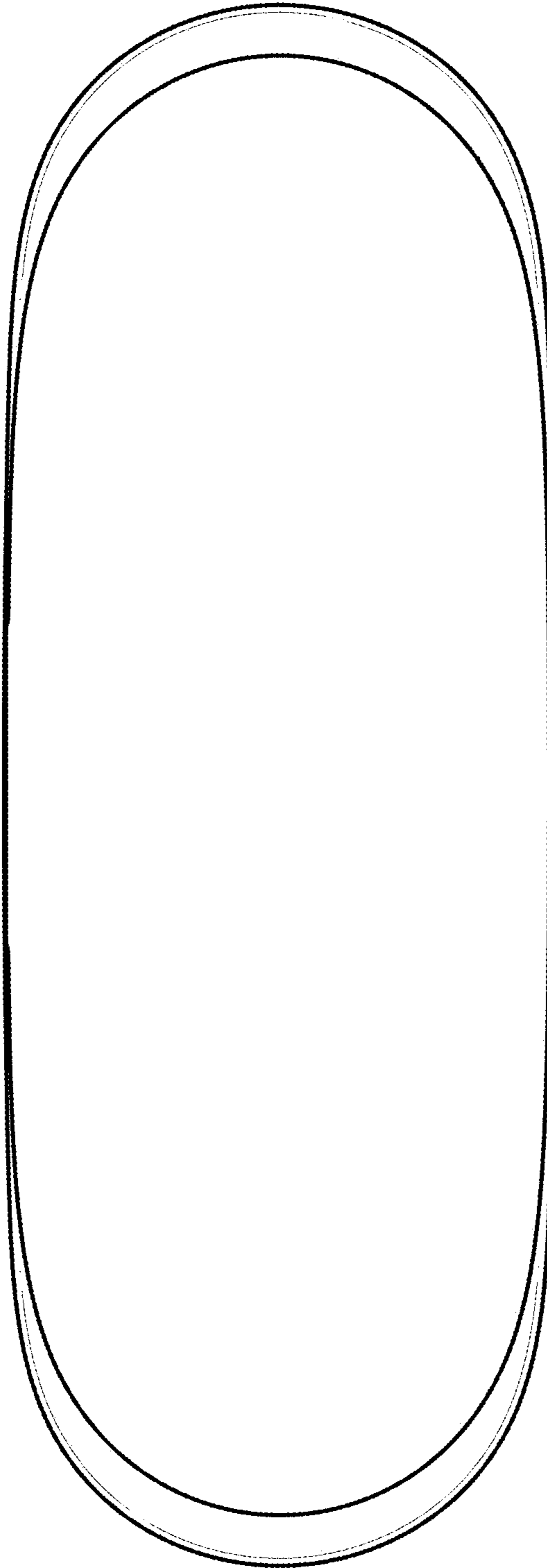

FIG. 7

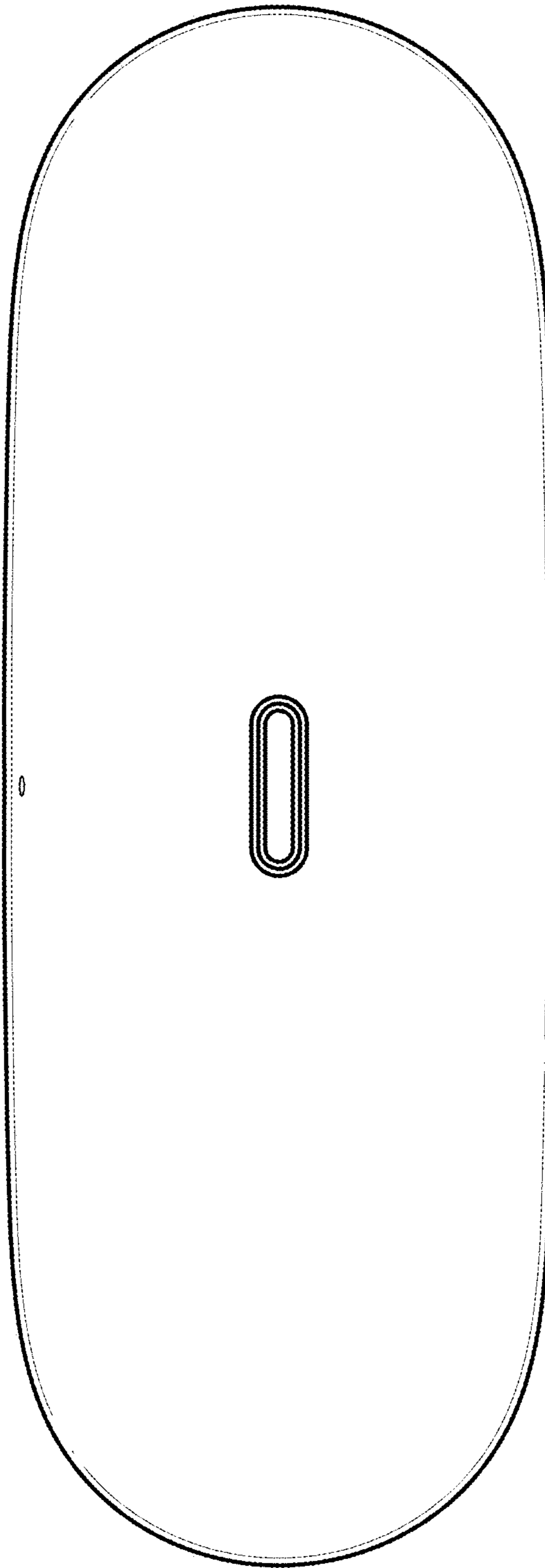

FIG. 8

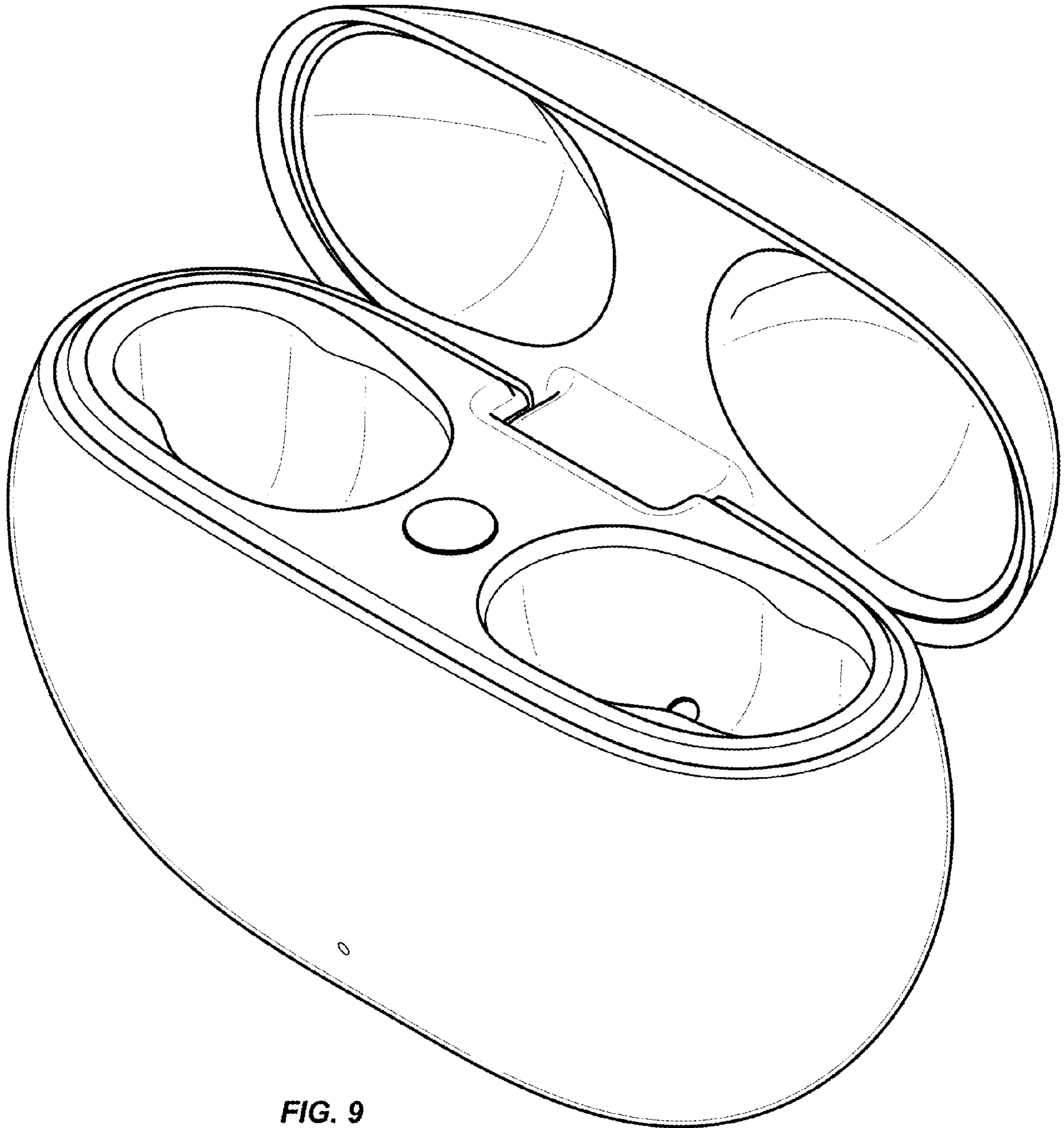

FIG. 9

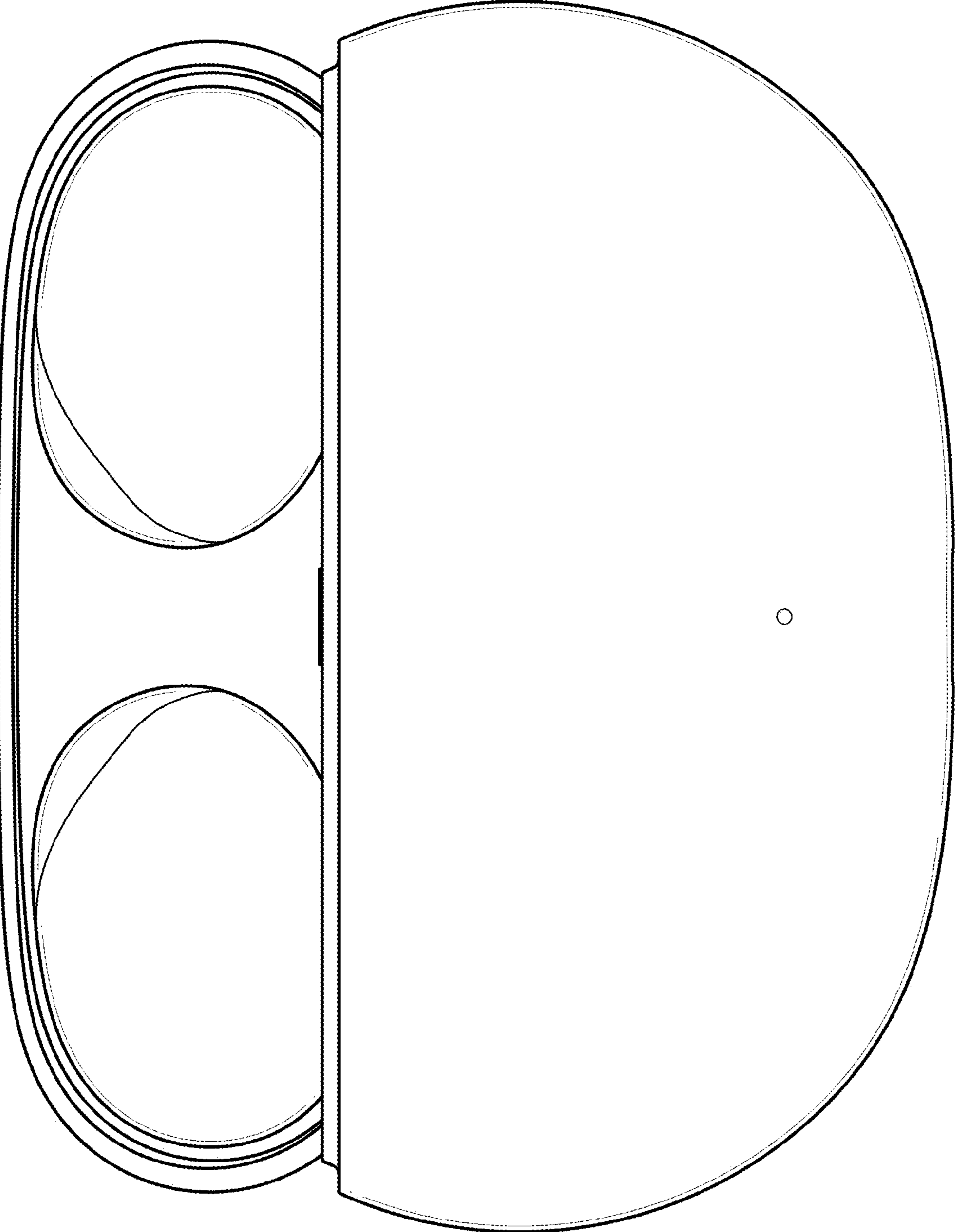

FIG. 10

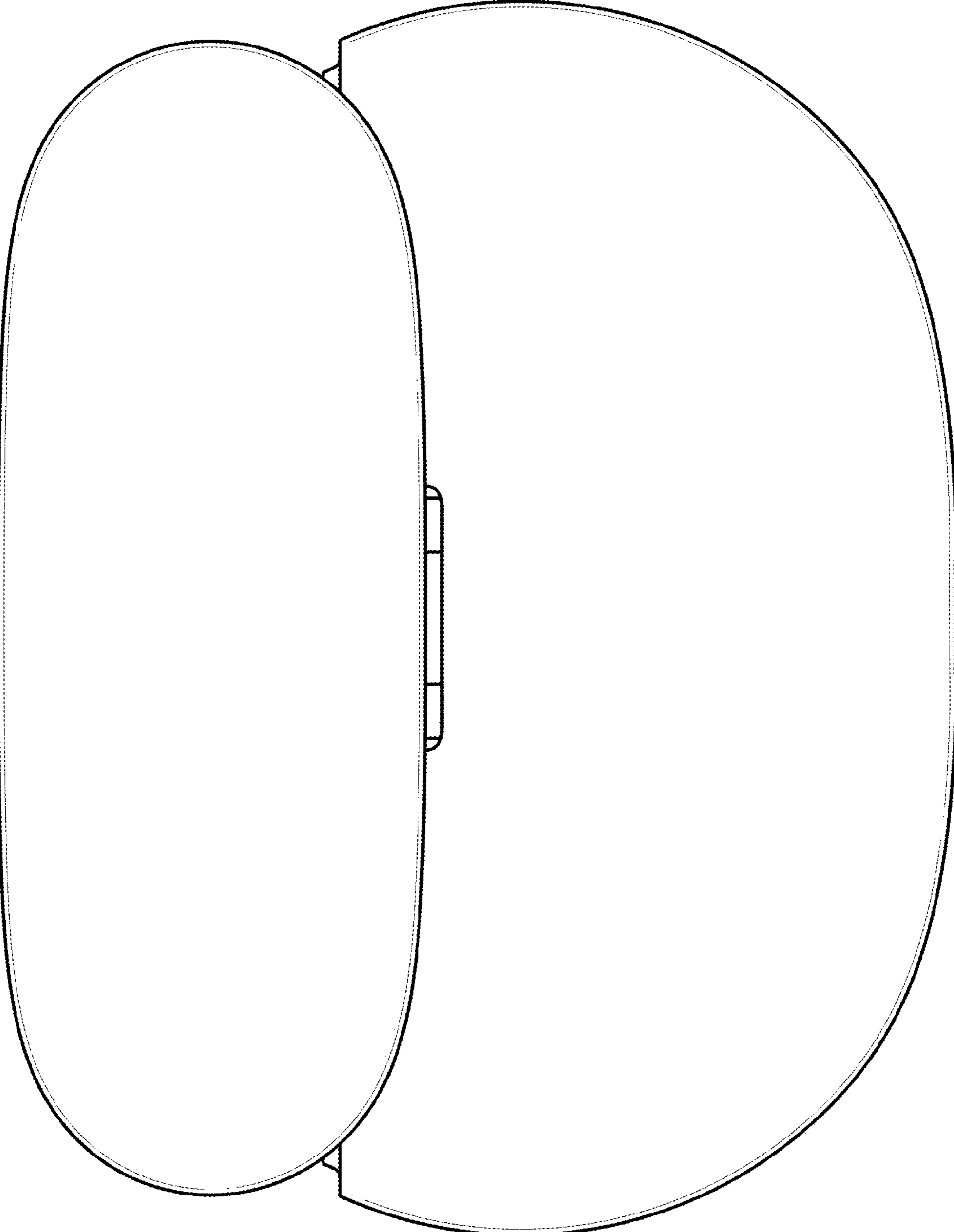

FIG. 11

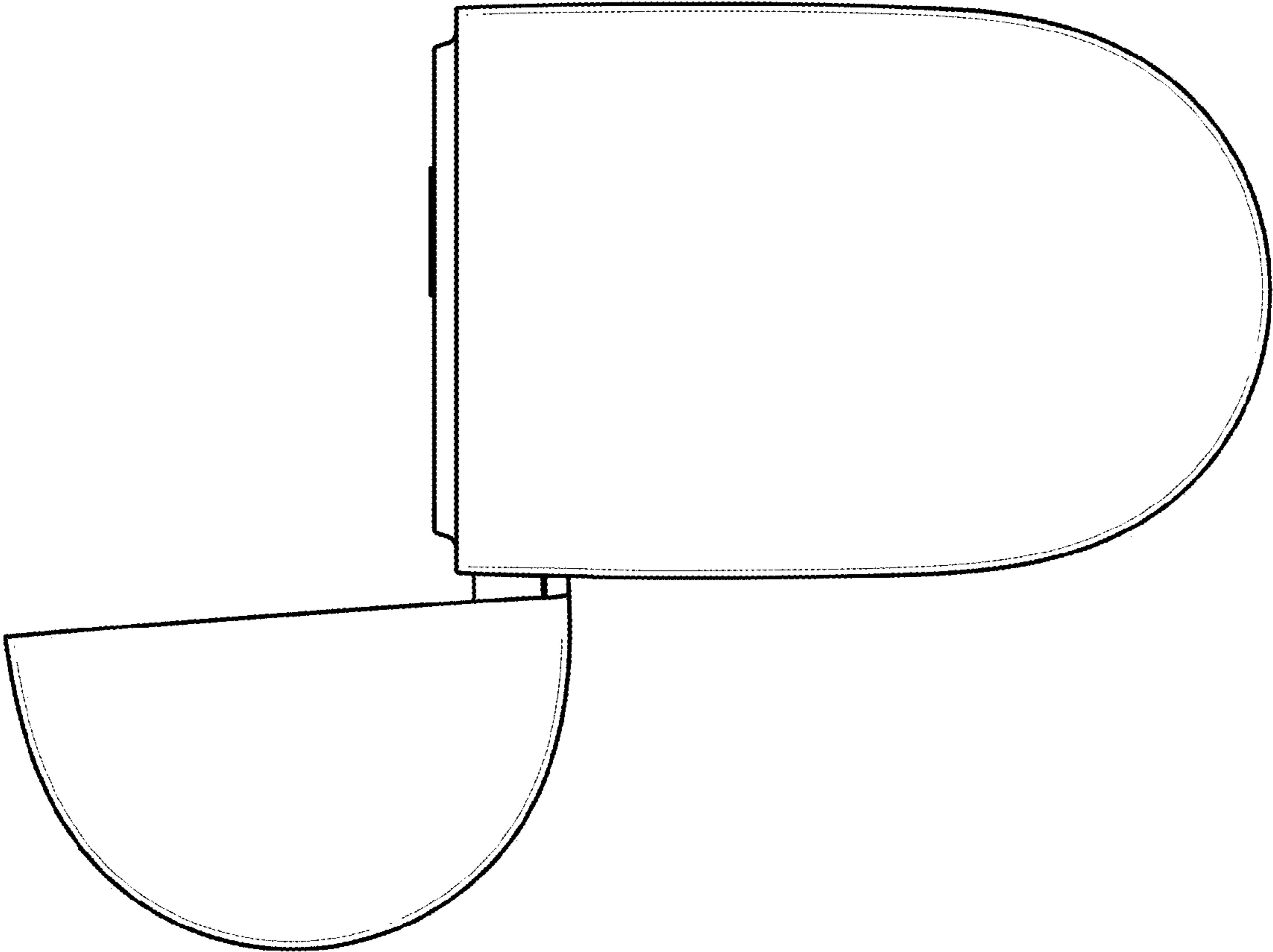

FIG. 12

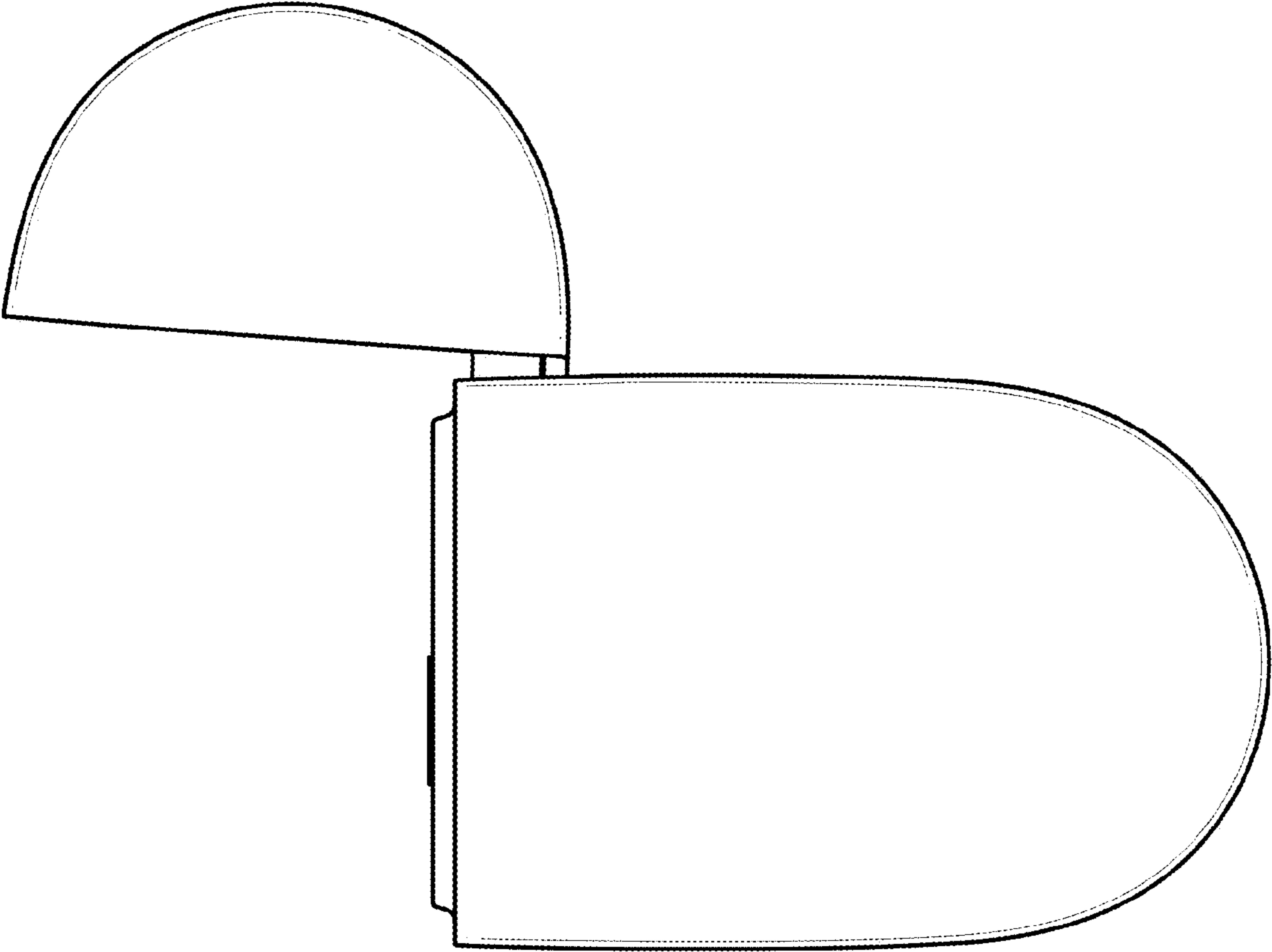

FIG. 13

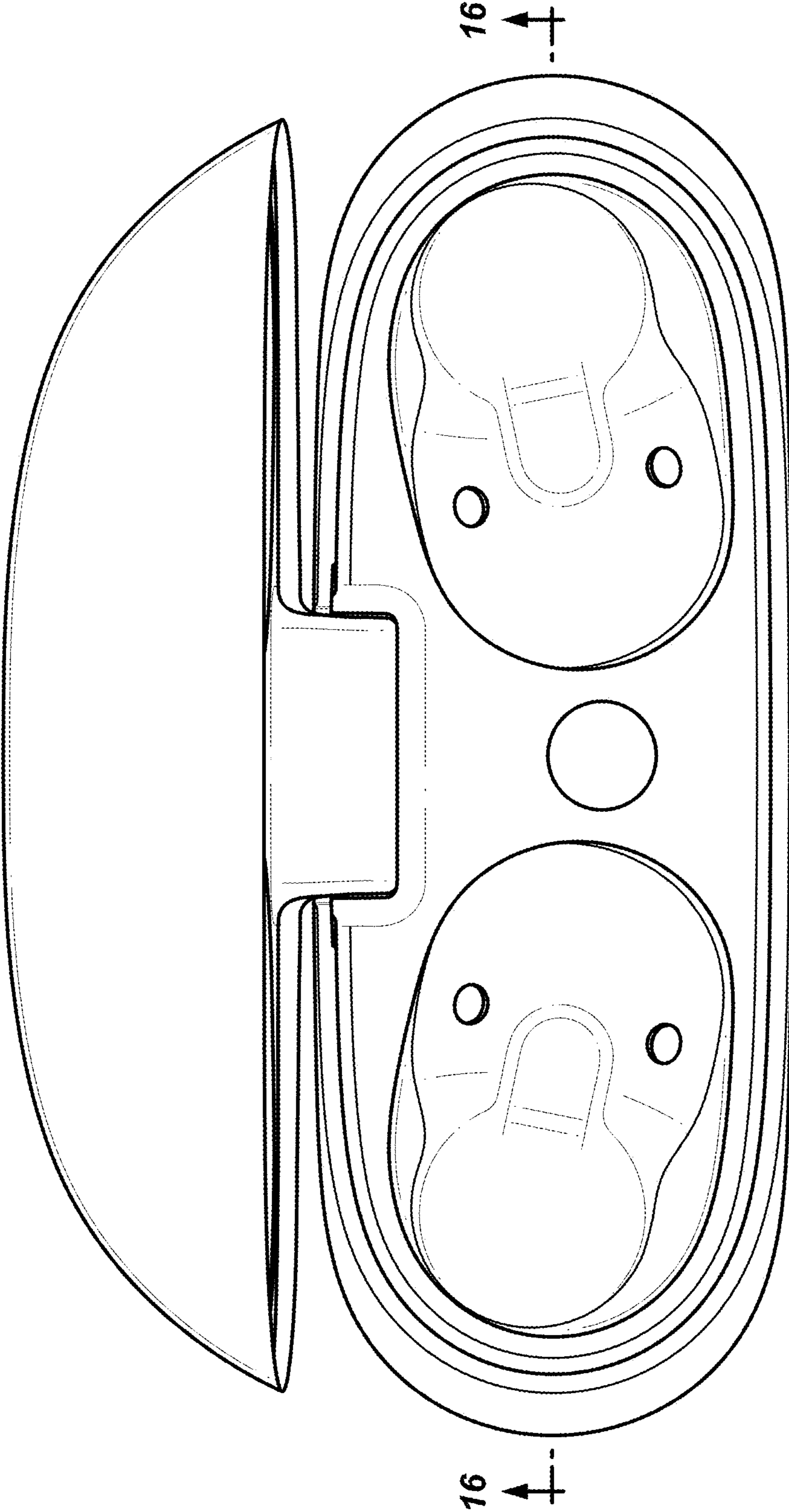

FIG. 14

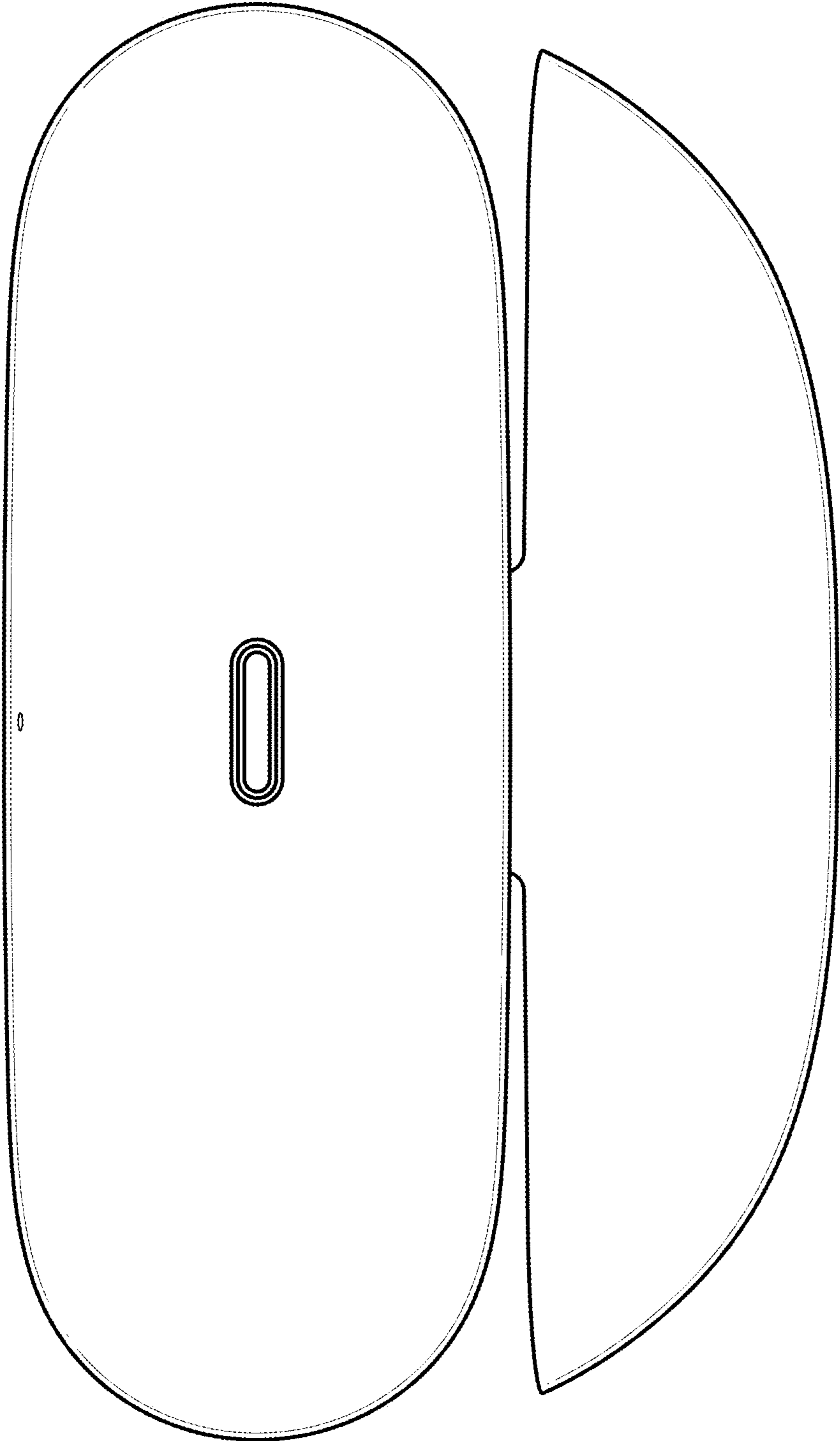

FIG. 15

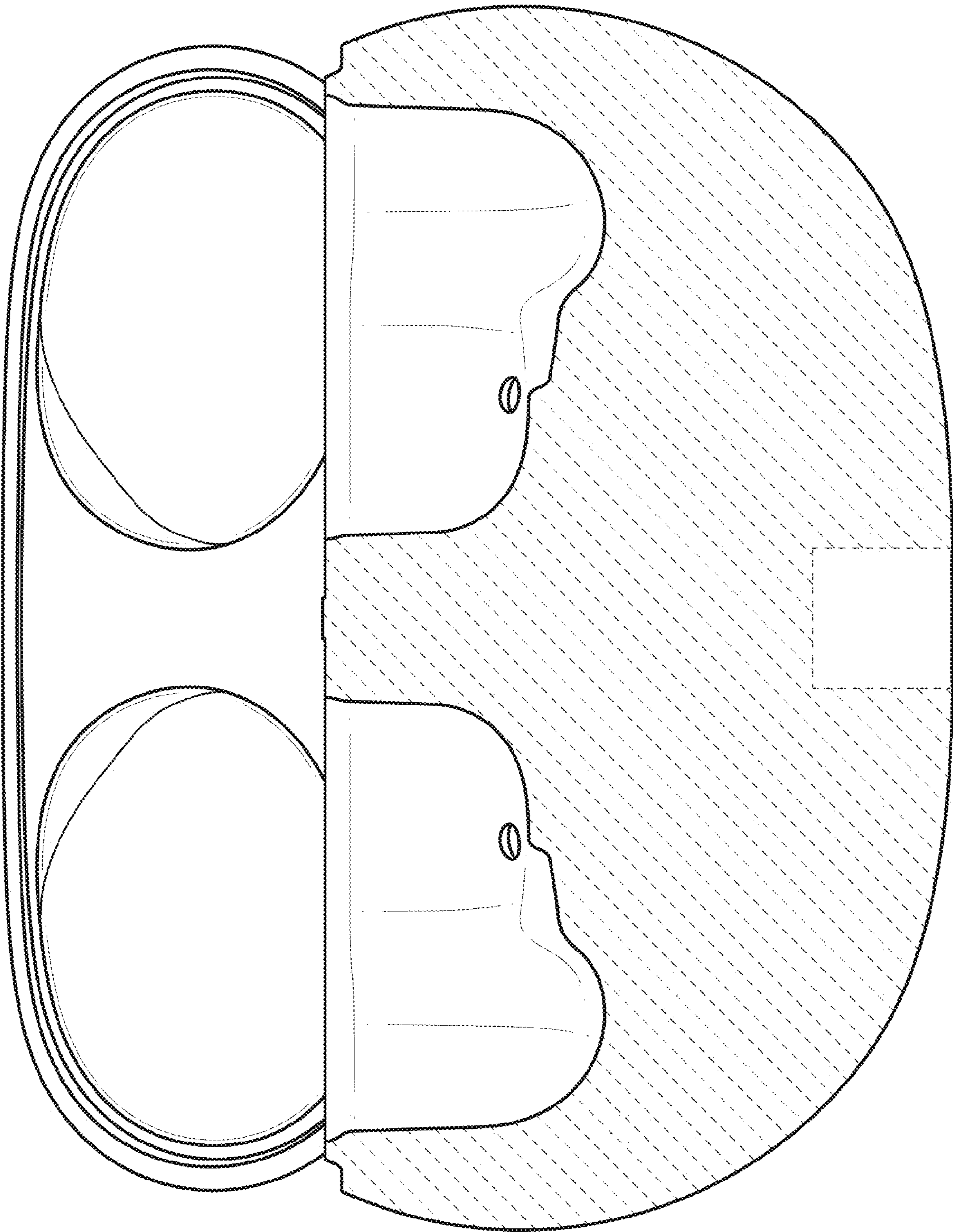

FIG. 16