



US00D958423S

(12) **United States Design Patent** (10) **Patent No.:** **US D958,423 S**  
**Wu** (45) **Date of Patent:** **\*\* Jul. 19, 2022**

(54) **VEHICLE LIGHT**

(56) **References Cited**

(71) Applicant: **COPLUS INC.**, Tainan (TW)

U.S. PATENT DOCUMENTS

(72) Inventor: **Po-Hua Wu**, Tainan (TW)

D676,166 S *	2/2013	Lai	.....	D26/28
D706,471 S *	6/2014	Lai	.....	D26/28
D718,893 S *	12/2014	Lai	.....	D26/28
D720,870 S *	1/2015	Lim	.....	D26/28
D721,450 S *	1/2015	Lai	.....	D26/28
D765,894 S *	9/2016	Lai	.....	D26/28
D840,565 S *	2/2019	Whitla	.....	D26/28
D844,198 S *	3/2019	Lin	.....	D26/28

(73) Assignee: **COPLUS INC.**, Tainan (TW)

(\*\*) Term: **15 Years**

\* cited by examiner

(21) Appl. No.: **29/762,839**

*Primary Examiner* — Marcus A Jackson

(22) Filed: **Dec. 18, 2020**

(74) *Attorney, Agent, or Firm* — Lewis Roca Rothgerber  
Chrisie LLP

(30) **Foreign Application Priority Data**

Oct. 22, 2020 (TW) ..... 109305850

(57) **CLAIM**

(51) **LOC (13) Cl.** ..... **26-06**

The ornamental design for a vehicle light, as shown and described.

(52) **U.S. Cl.**

USPC ..... **D26/28**

**DESCRIPTION**

(58) **Field of Classification Search**

USPC ..... D26/28–36, 139

CPC ..... F21S 48/00; F21S 48/10; F21S 48/115;

F21S 48/225; F21S 48/1233; F21S

48/1266; F21S 48/1388; F21S 48/2268;

F21V 5/00; F21V 21/04; F21V 29/004;

B60Q 9/13; B60Q 9/135; B60Q 9/1375;

F21W 2102/17; F21W 2103/00; F21W

2103/35; F21W 2103/55; F21W 2107/13;

F21W 2107/17

FIG. 1 is a perspective view of the vehicle light;

FIG. 2 is a front view thereof;

FIG. 3 is a rear view thereof;

FIG. 4 is a left side view thereof;

FIG. 5 is a right side view thereof;

FIG. 6 is a top view thereof; and,

FIG. 7 is a bottom view thereof.

The broken lines in the drawings depict portions of the article that form no part of the claimed design.

See application file for complete search history.

**1 Claim, 7 Drawing Sheets**

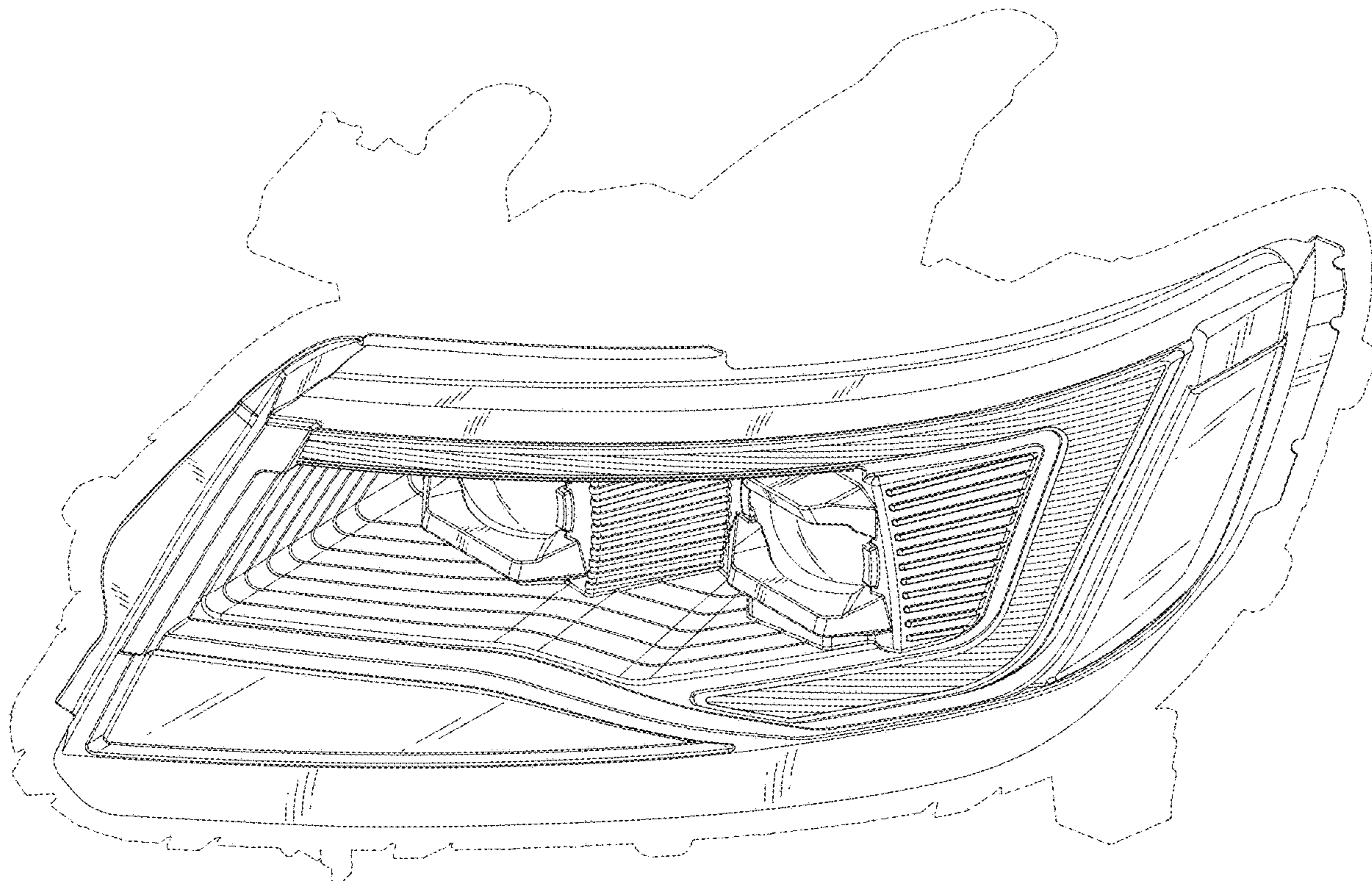

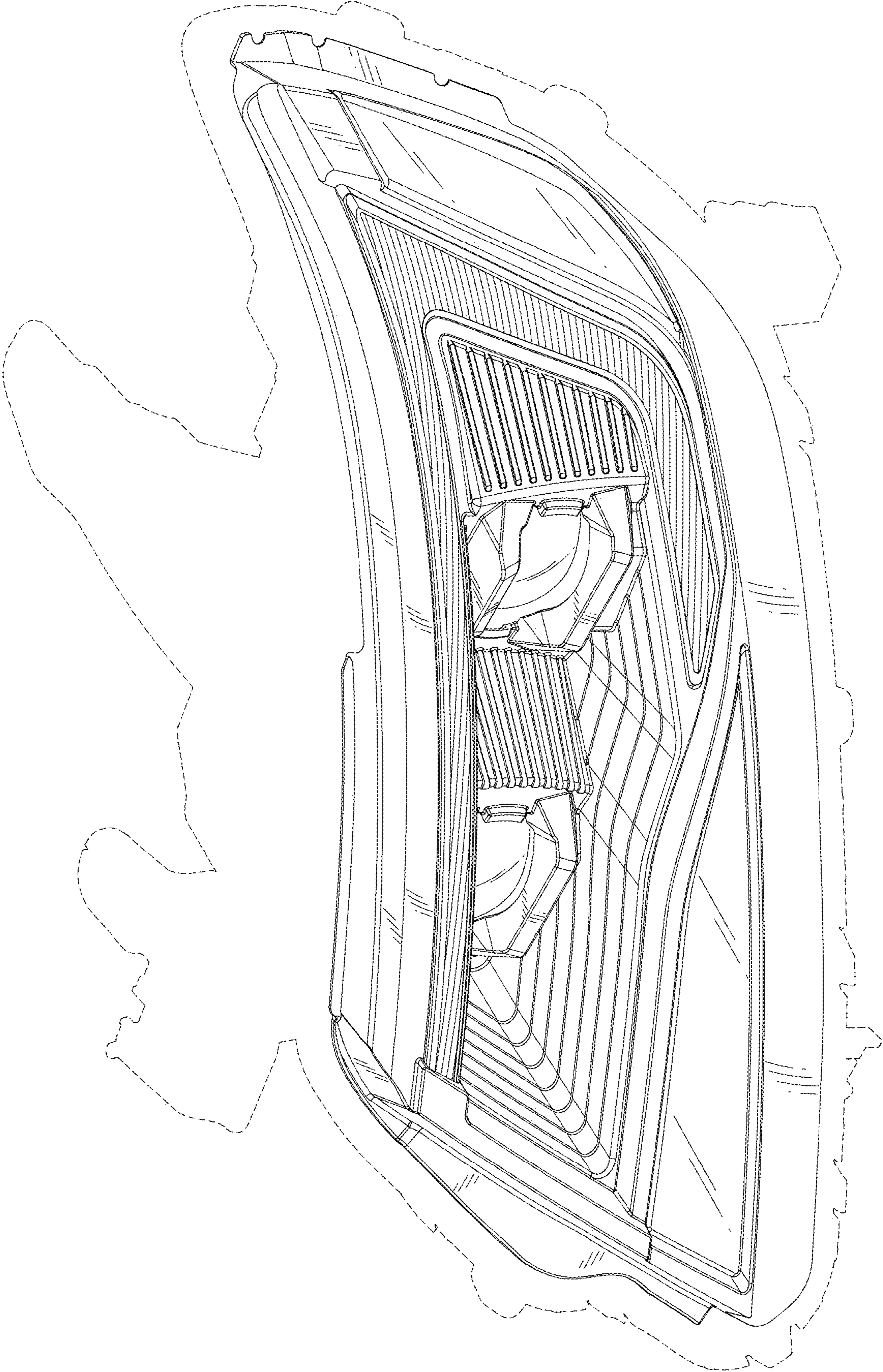

FIG. 1

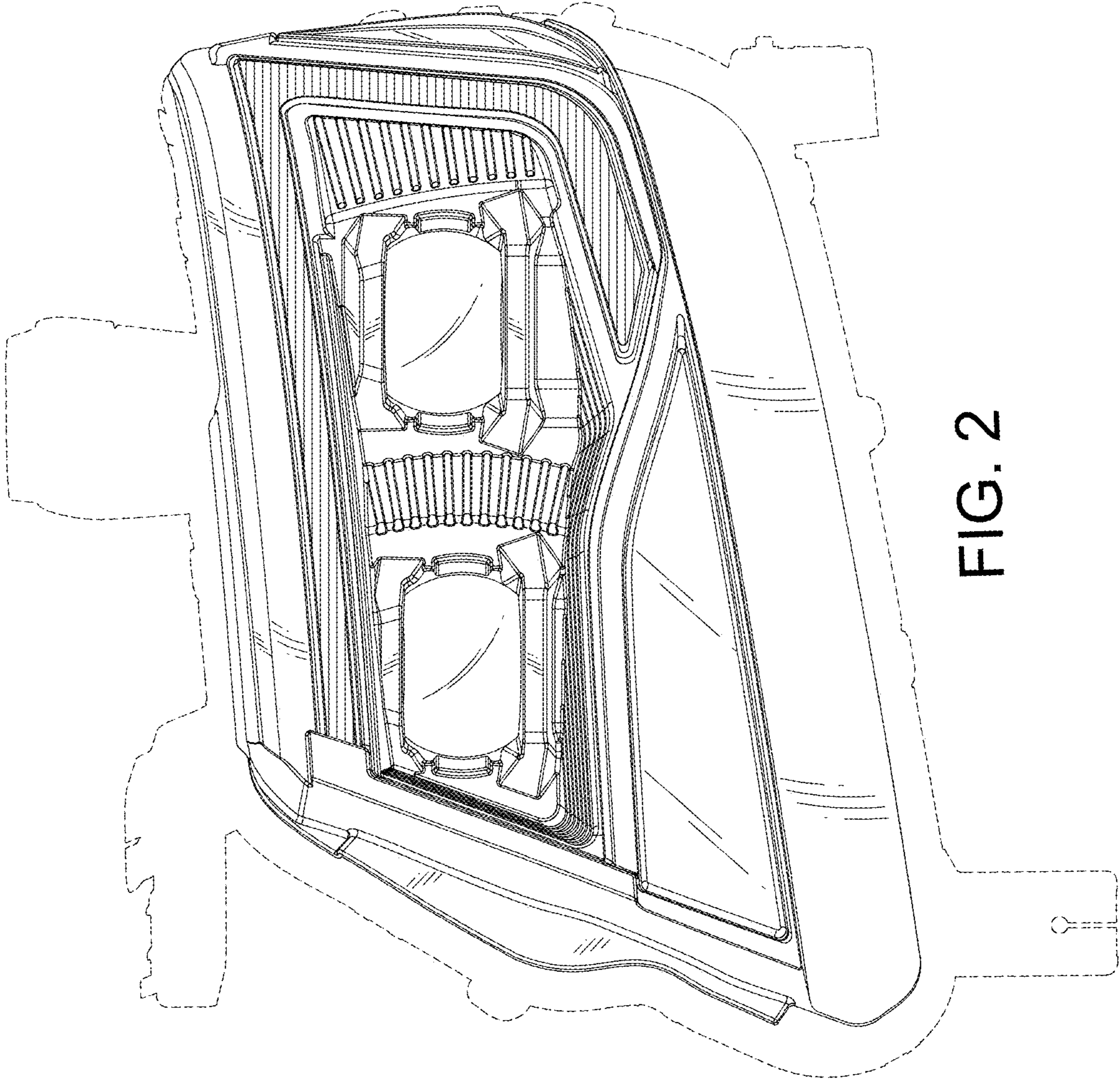

FIG. 2

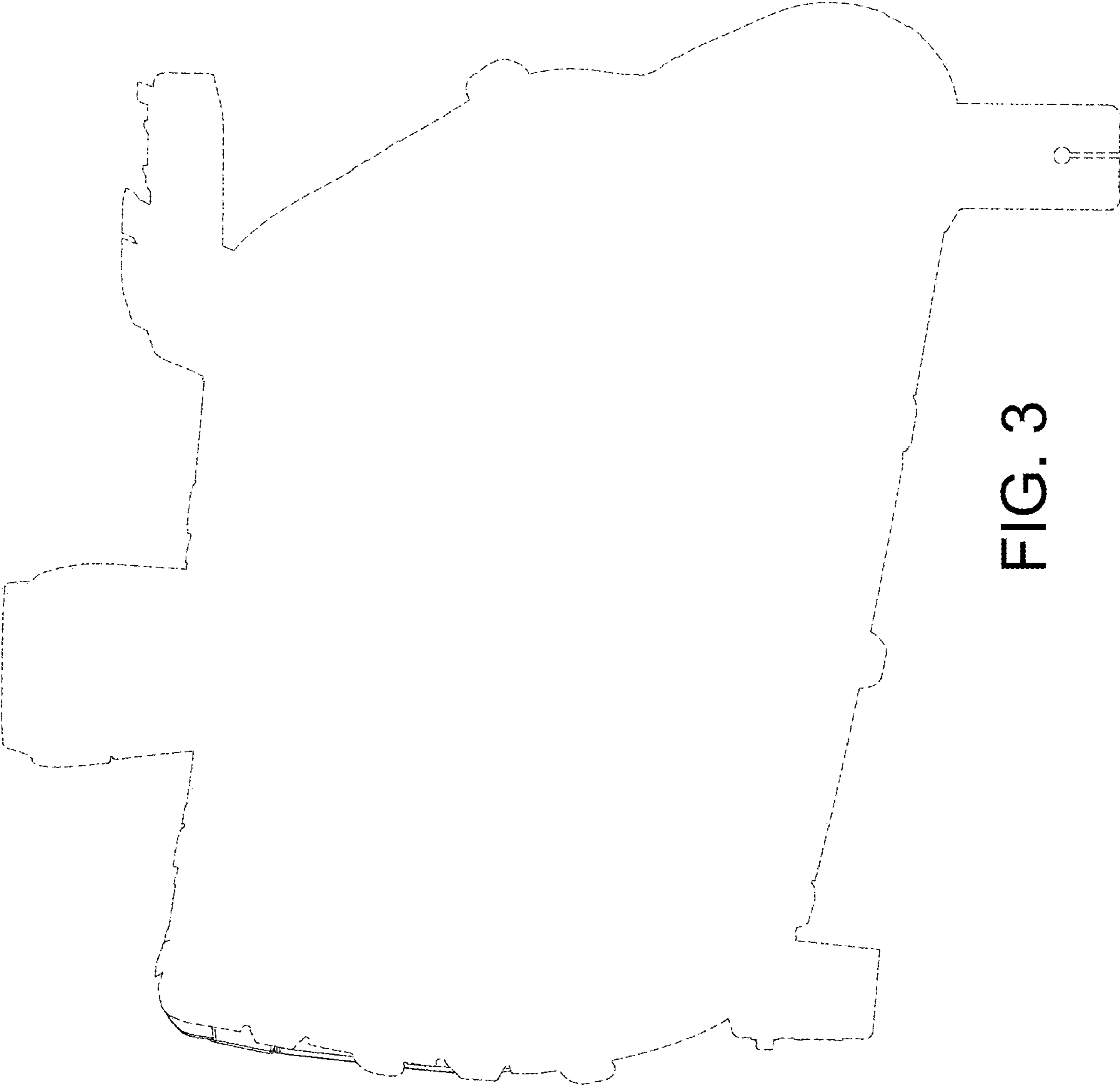

FIG. 3

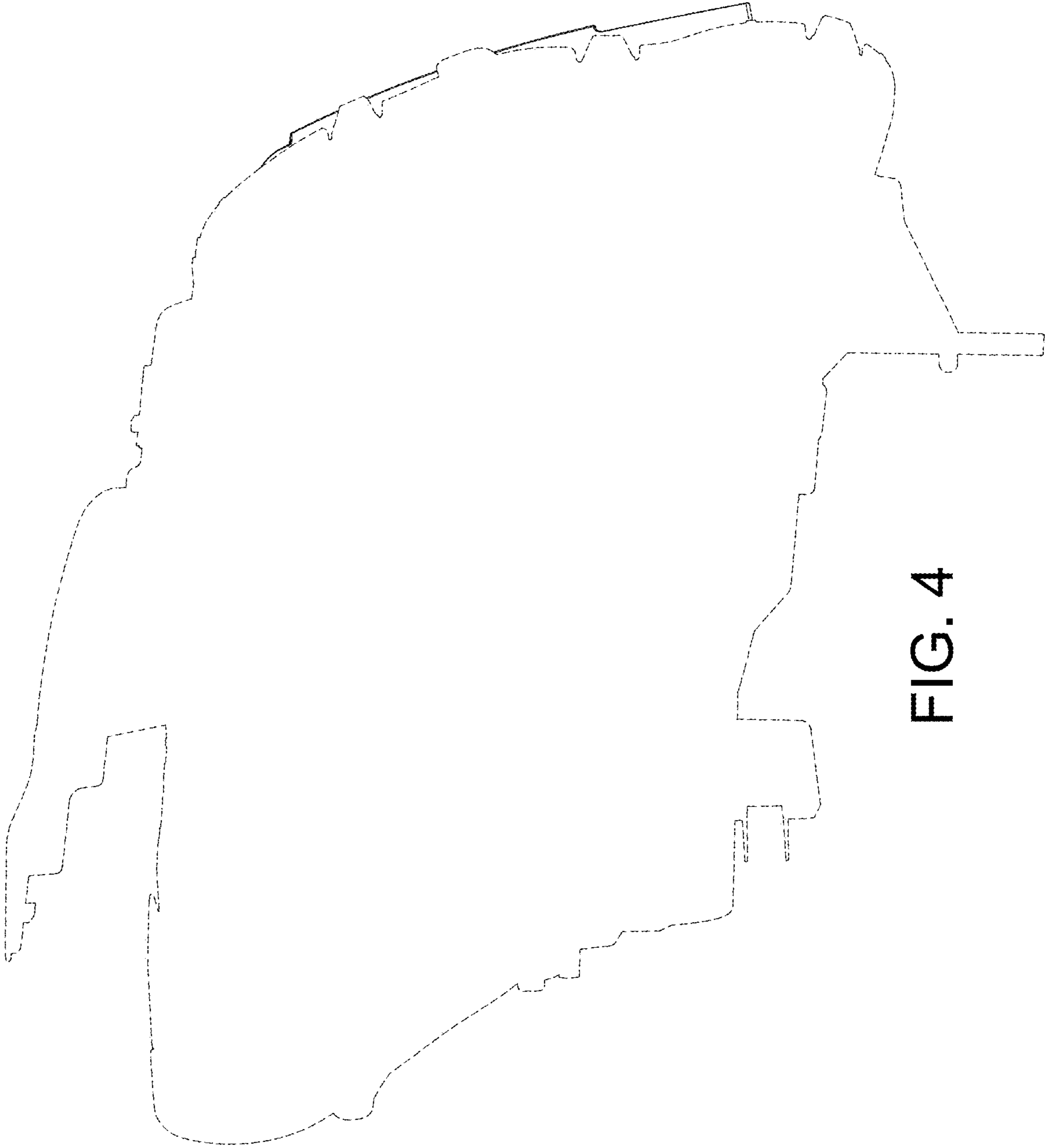

FIG. 4

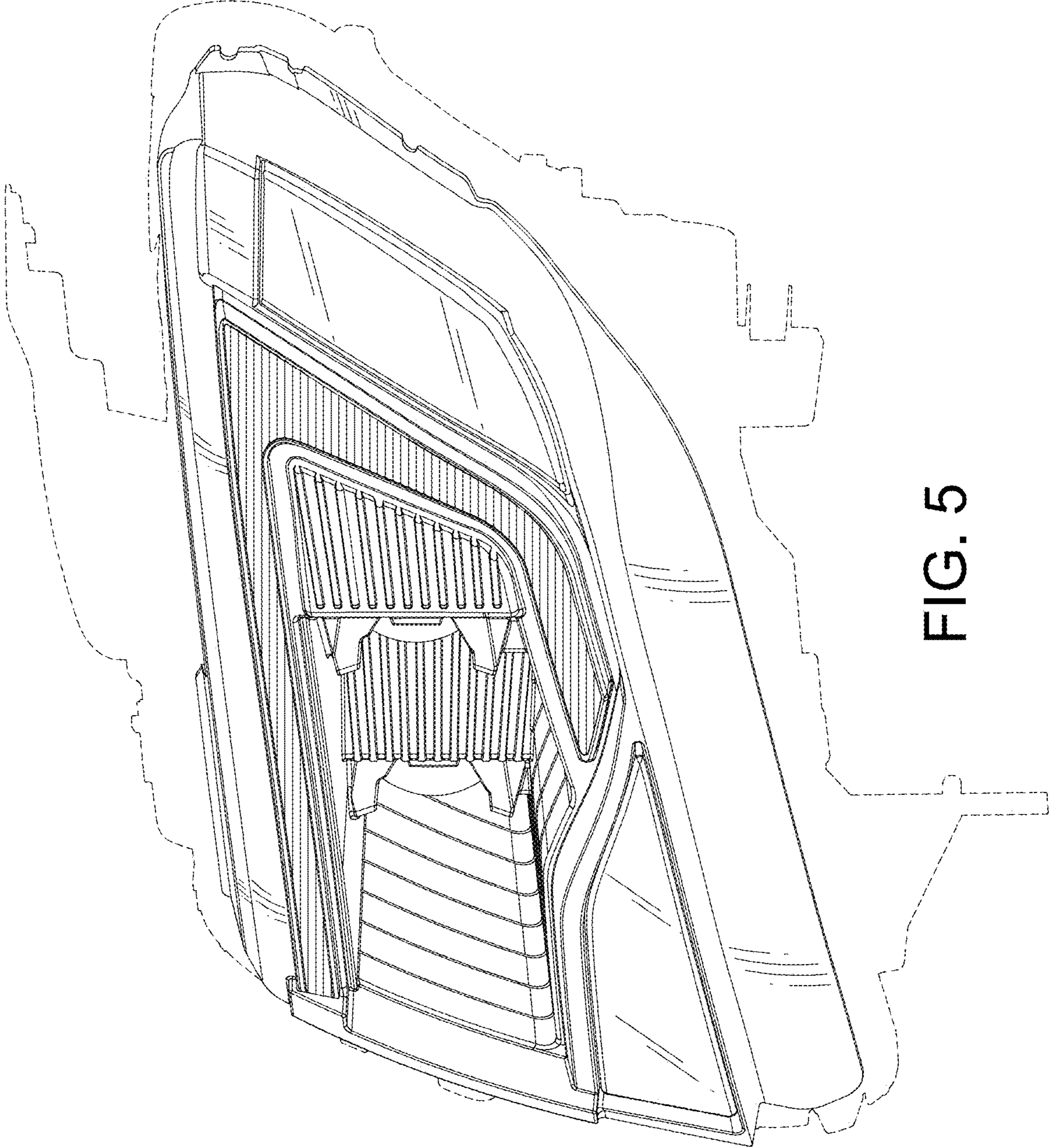

FIG. 5

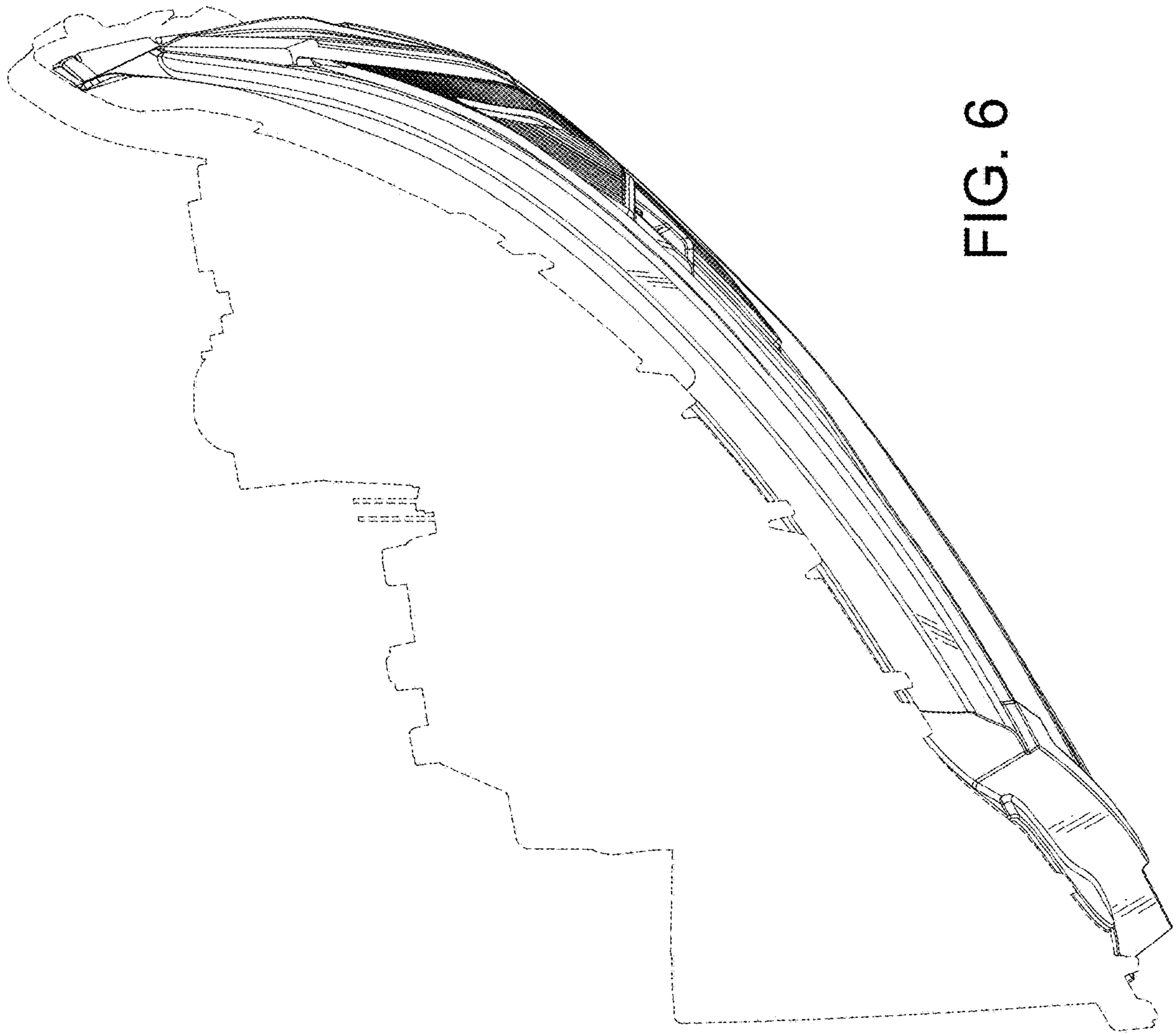

FIG. 6

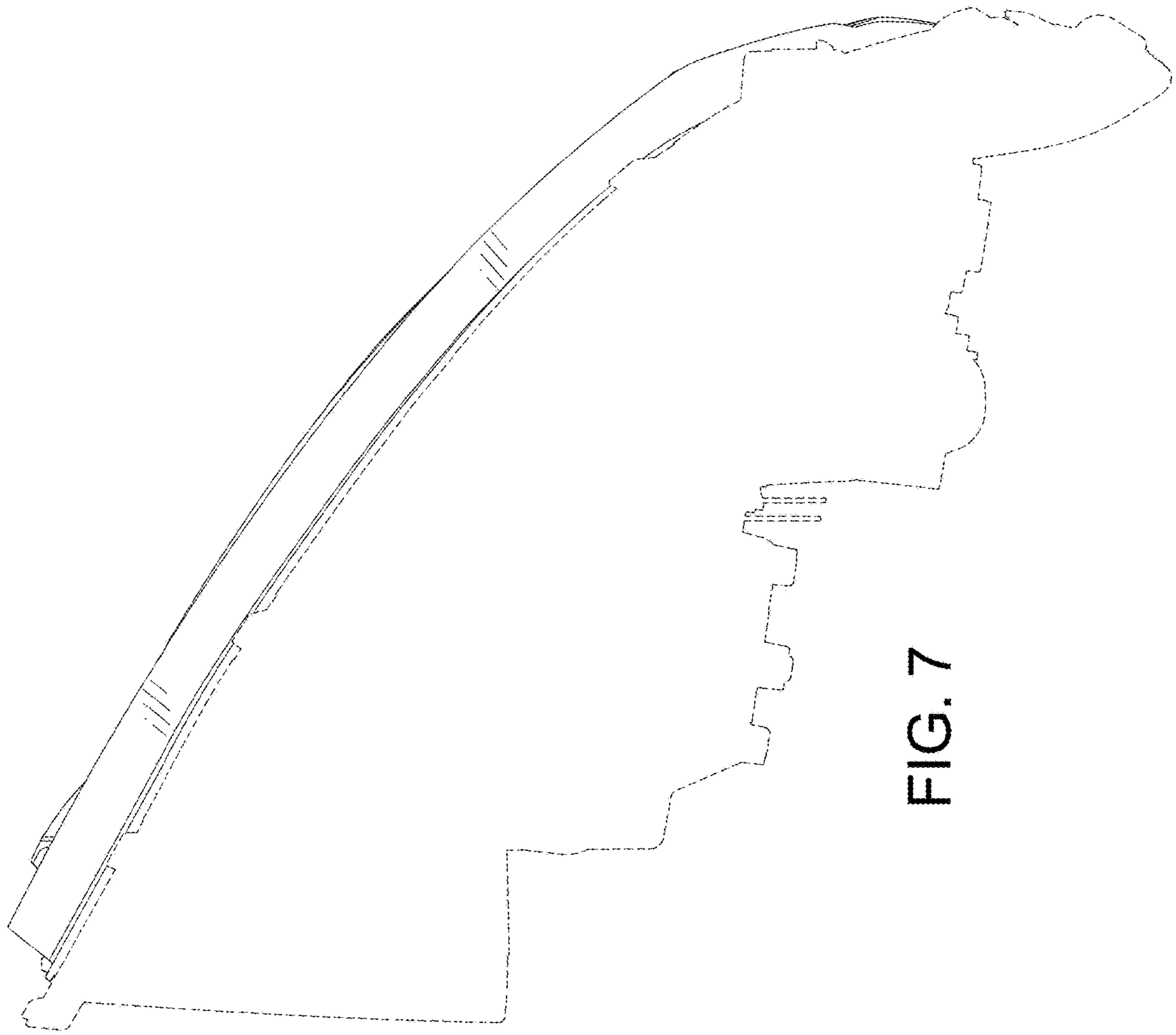

FIG. 7