



US00D958372S

(12) **United States Design Patent** (10) **Patent No.:** **US D958,372 S**
Christiansen (45) **Date of Patent:** **** Jul. 19, 2022**

(54) **HEARING AID**

(71) Applicant: **GN Hearing A/S**, Ballerup (DK)

(72) Inventor: **Henrik Hetz Christiansen**,
Copenhagen K (DK)

(**) Term: **15 Years**

(21) Appl. No.: **35/509,885**

(22) Filed: **Jun. 22, 2020**

(80) **Hague Agreement Data**

Int. Filing Date: **Jun. 22, 2020**

Int. Reg. No.: **DM/209306**

Int. Reg. Date: **Jun. 22, 2020**

Int. Reg. Pub. Date: **Jul. 24, 2020**

(51) **LOC (13) Cl.** **24-99**

(52) **U.S. Cl.**
USPC **D24/174**

(58) **Field of Classification Search**
USPC D24/173; D14/205, 226
CPC ... H04R 2225/025; H04R 25/60; H04R 25/65
See application file for complete search history.

(56) **References Cited**

U.S. PATENT DOCUMENTS

- D676,968 S * 2/2013 Meinertz D24/174
- D698,025 S * 1/2014 Jensen D24/174
- D720,460 S * 12/2014 Jensen D24/174
- D762,305 S * 7/2016 Gabathuler D24/174

- D805,203 S * 12/2017 Meinertz D24/174
- D806,252 S * 12/2017 Lockenwitz D24/174
- D837,984 S * 1/2019 Christiansen D24/151
- D851,770 S * 6/2019 Christiansen D24/174
- D852,363 S * 6/2019 Christiansen D24/174
- D853,568 S * 7/2019 Christiansen D24/174
- D861,171 S * 9/2019 Christiansen D24/174
- D872,280 S * 1/2020 Shi D24/174
- D932,022 S * 9/2021 Tamsiran D24/174

* cited by examiner

Primary Examiner — Calvin E Vansant

(57) **CLAIM**

The ornamental design for a hearing aid, as shown and described.

DESCRIPTION

- Hearing aid
- 1.1 : Perspective
 - 1.2 : Left
 - 1.3 : Right
 - 1.4 : Bottom
 - 1.5 : Top
 - 1.6 : Front
 - 1.7 : Back
 - 3.1 : Perspective
 - 3.2 : Left
 - 3.3 : Right
 - 3.4 : Bottom
 - 3.5 : Top
 - 3.6 : Back
 - 3.7 : Front

1 Claim, 14 Drawing Sheets

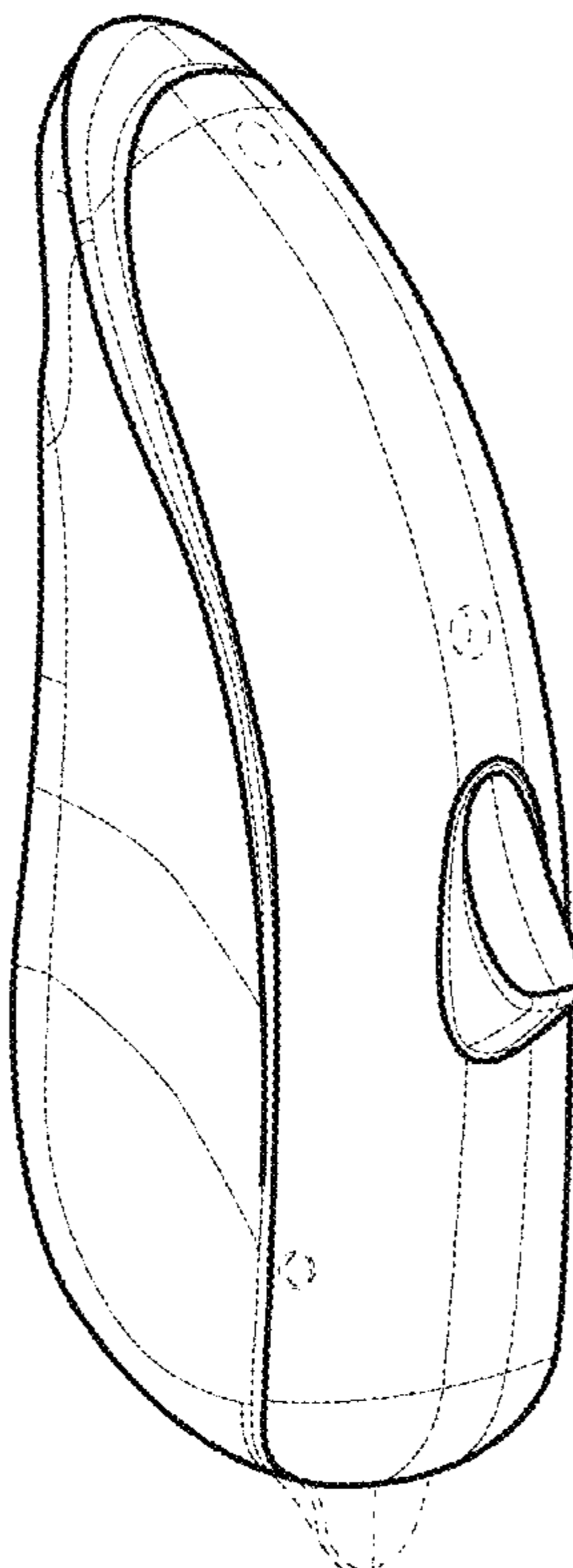

1.1

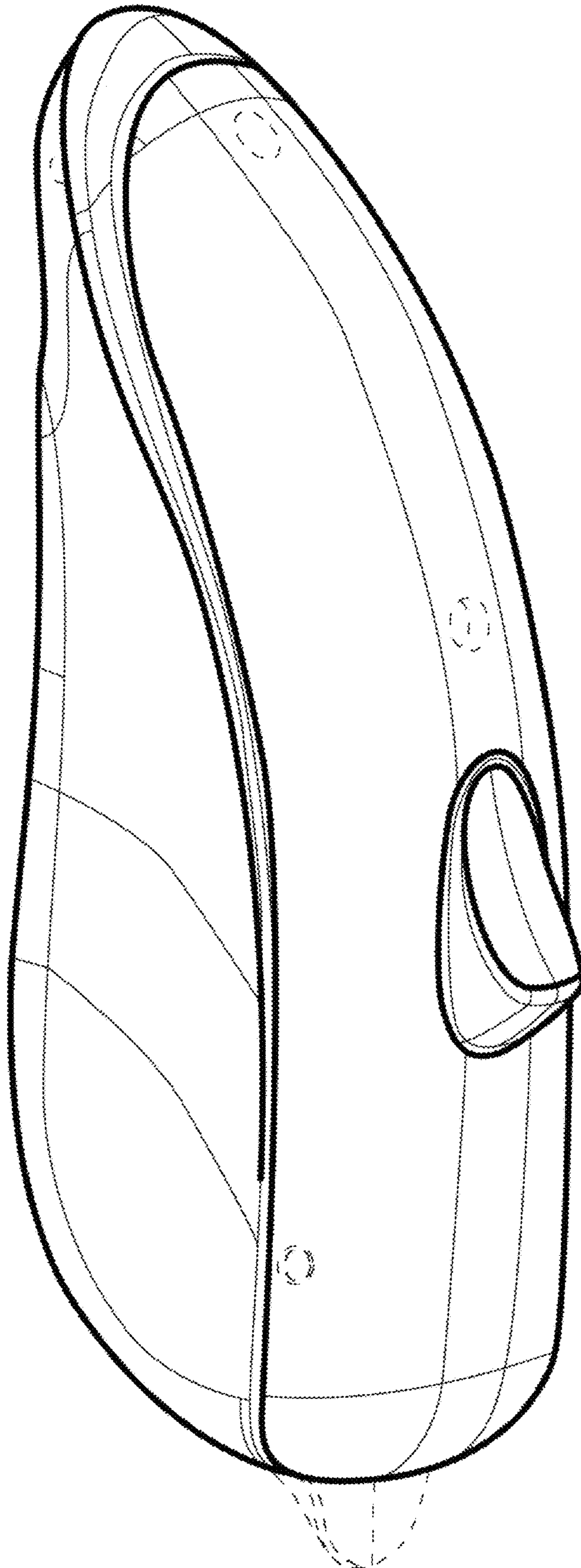

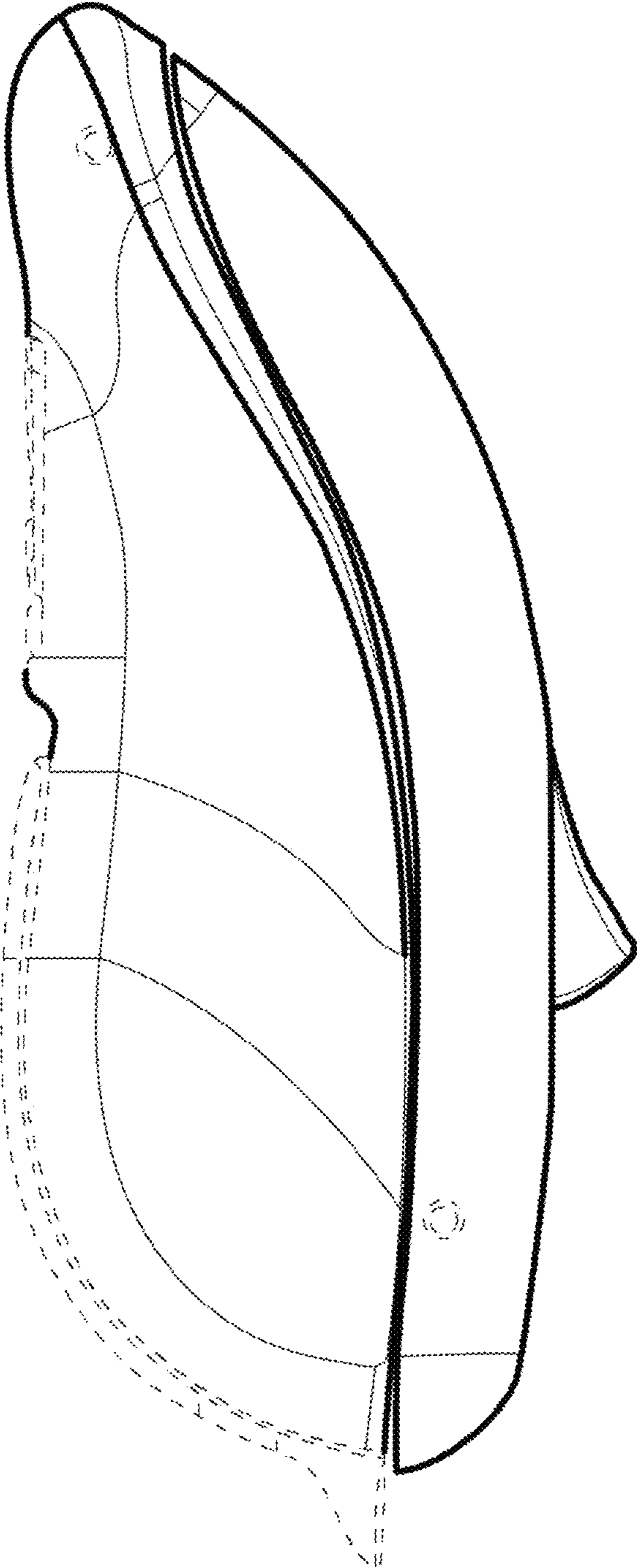

FIG. 1.2

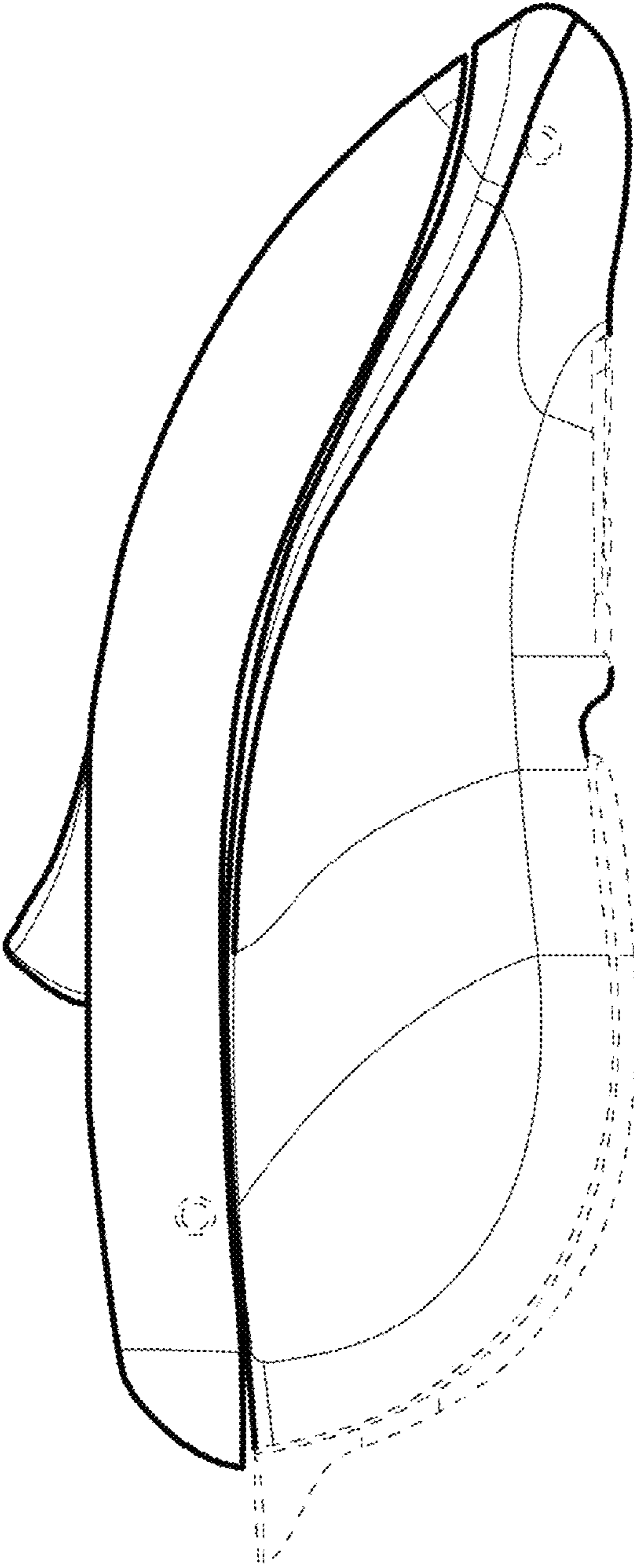

FIG. 1.3

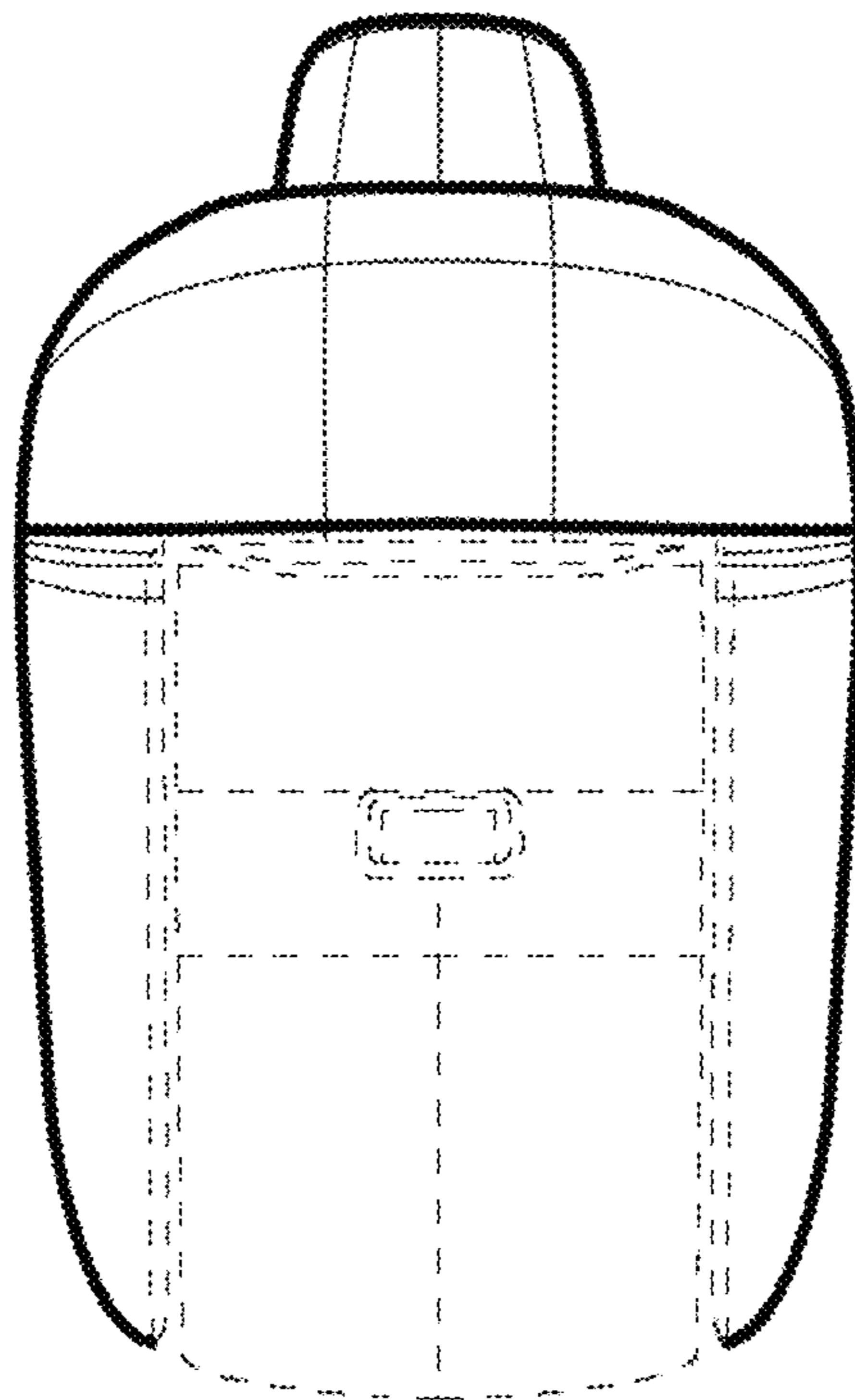

FIG. 1.4

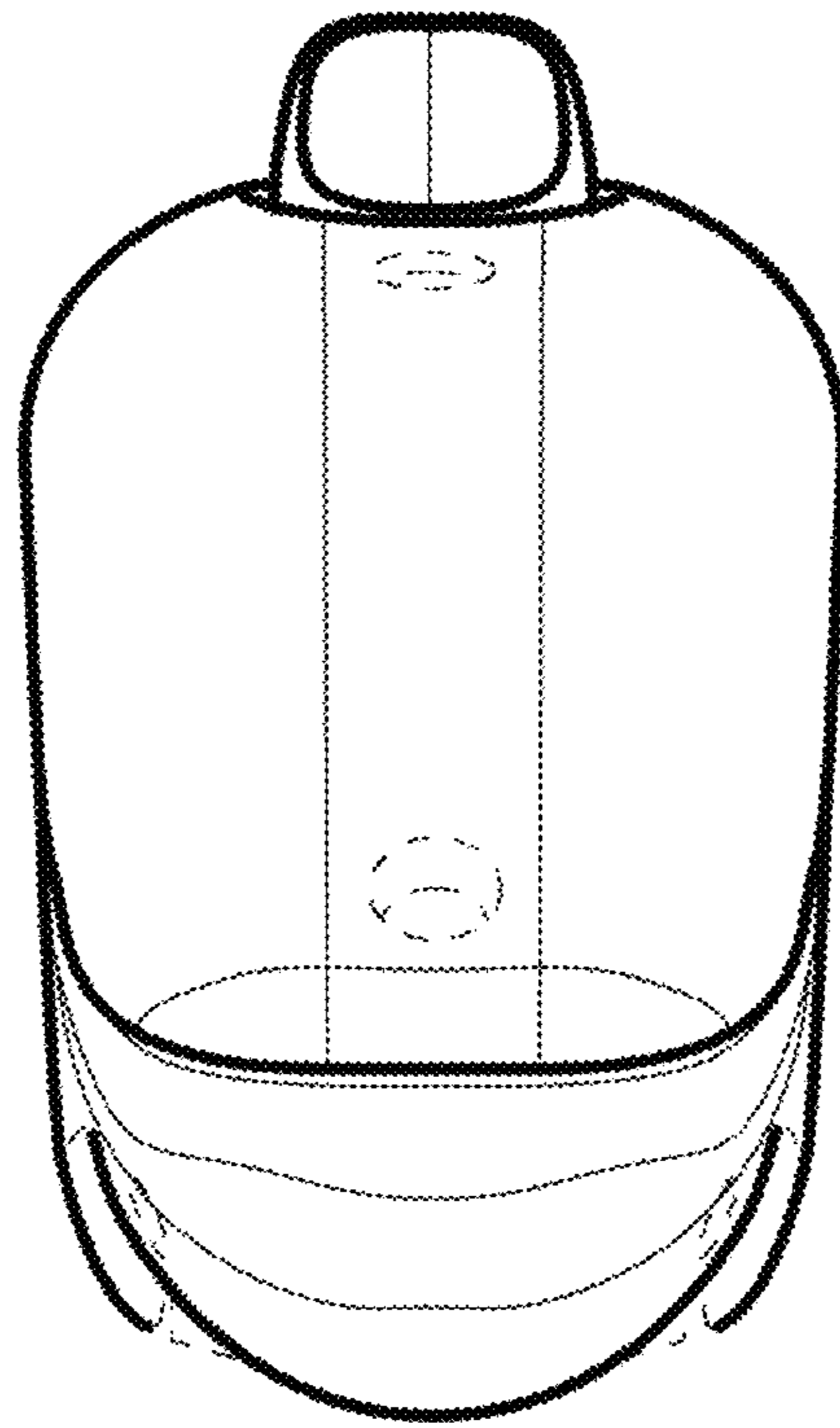

FIG. 1.5

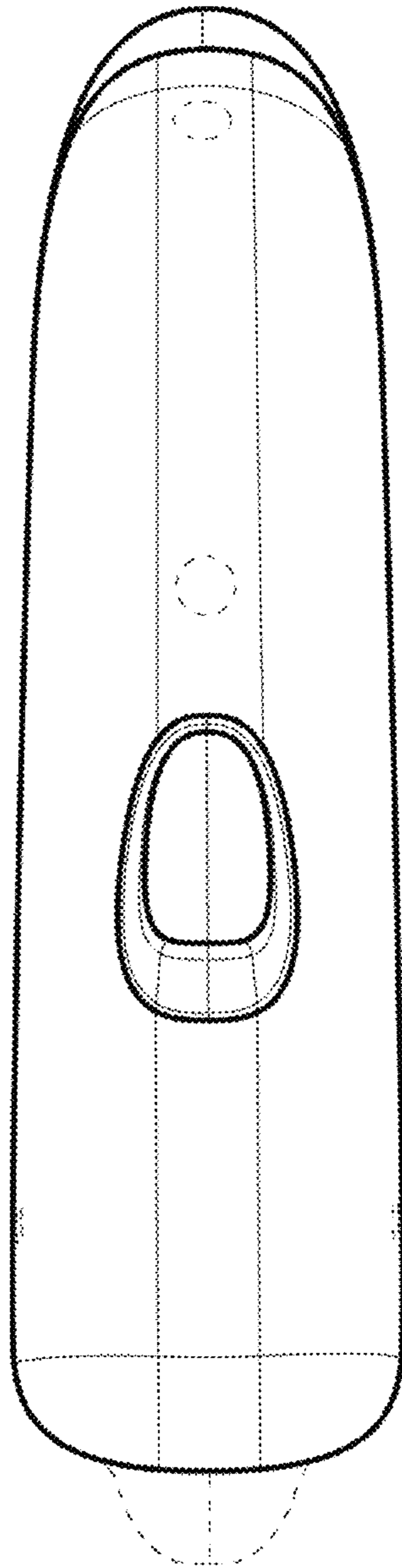
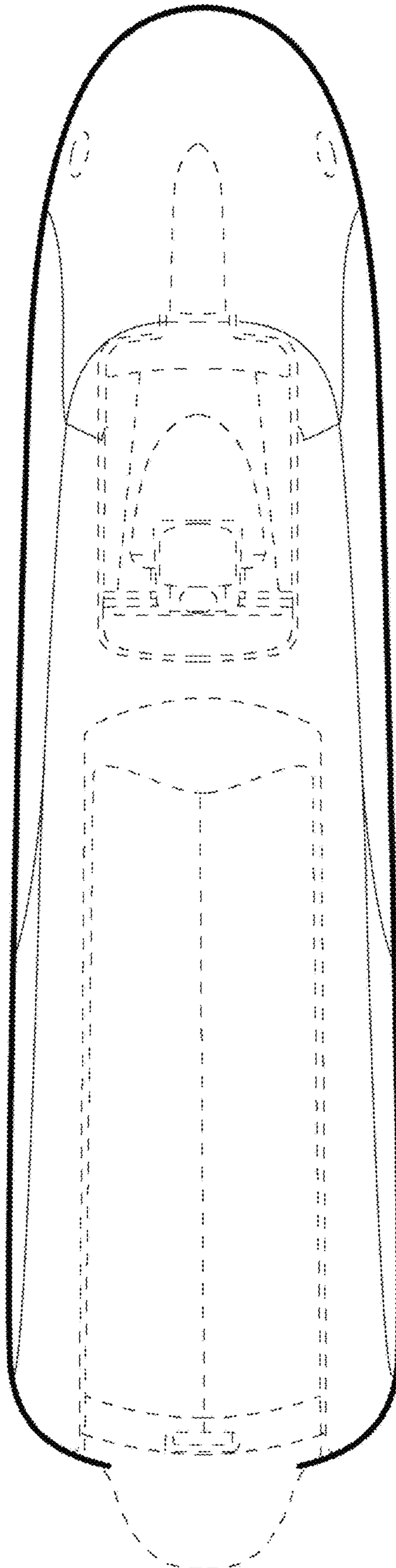
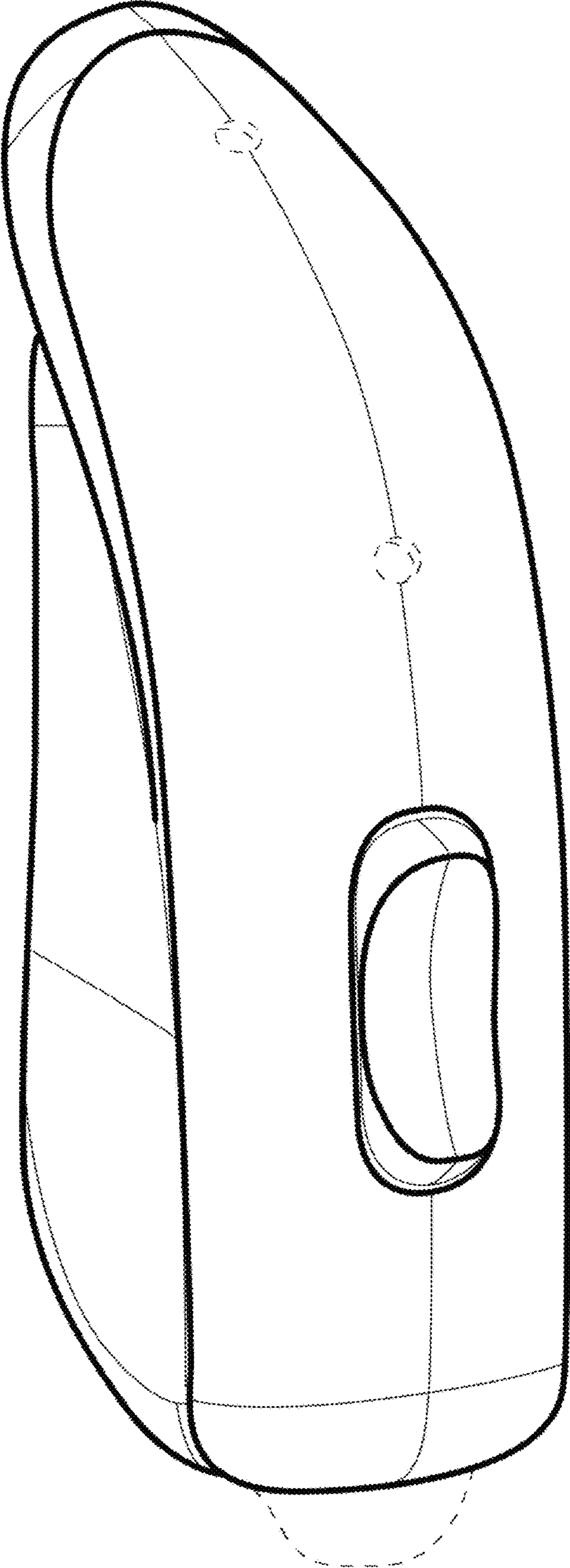

FIG. 1.6

1.7



3.1



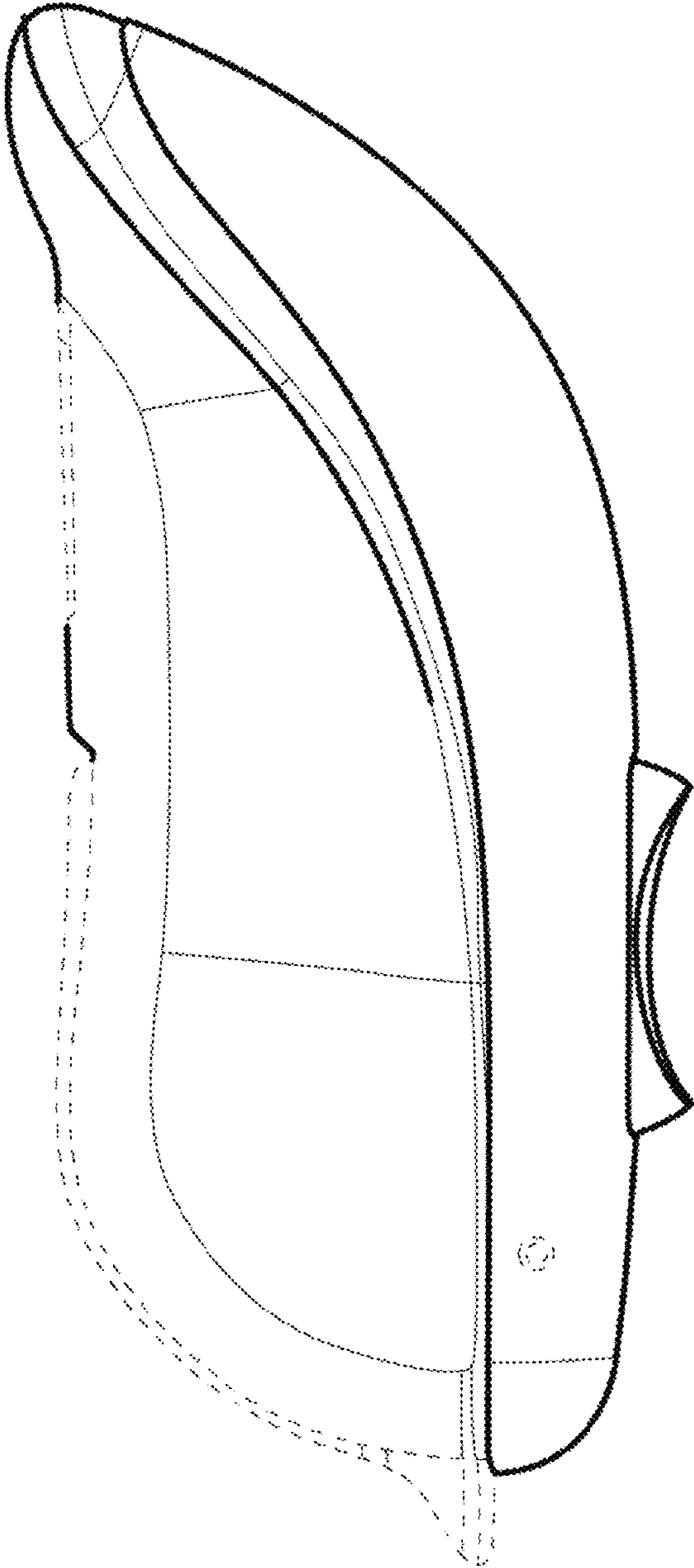

FIG. 3.2

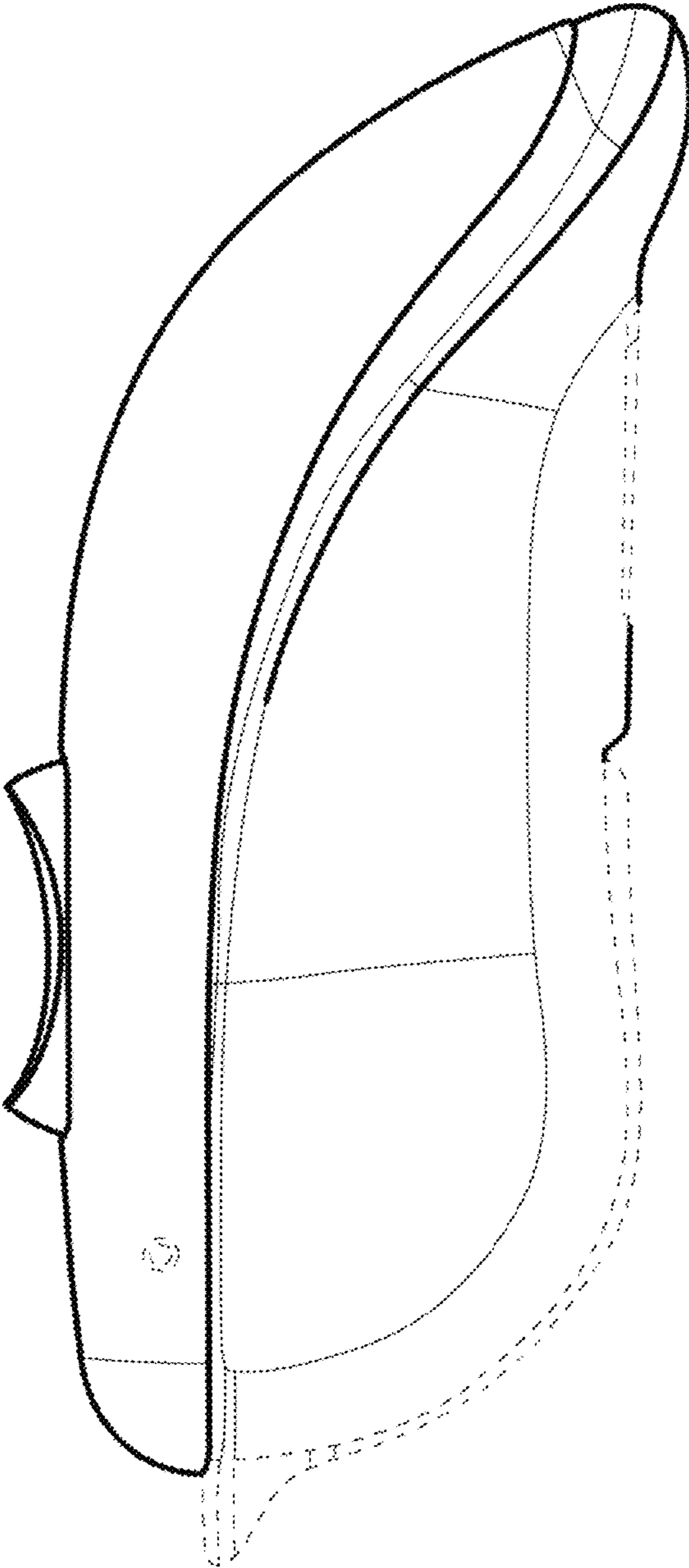
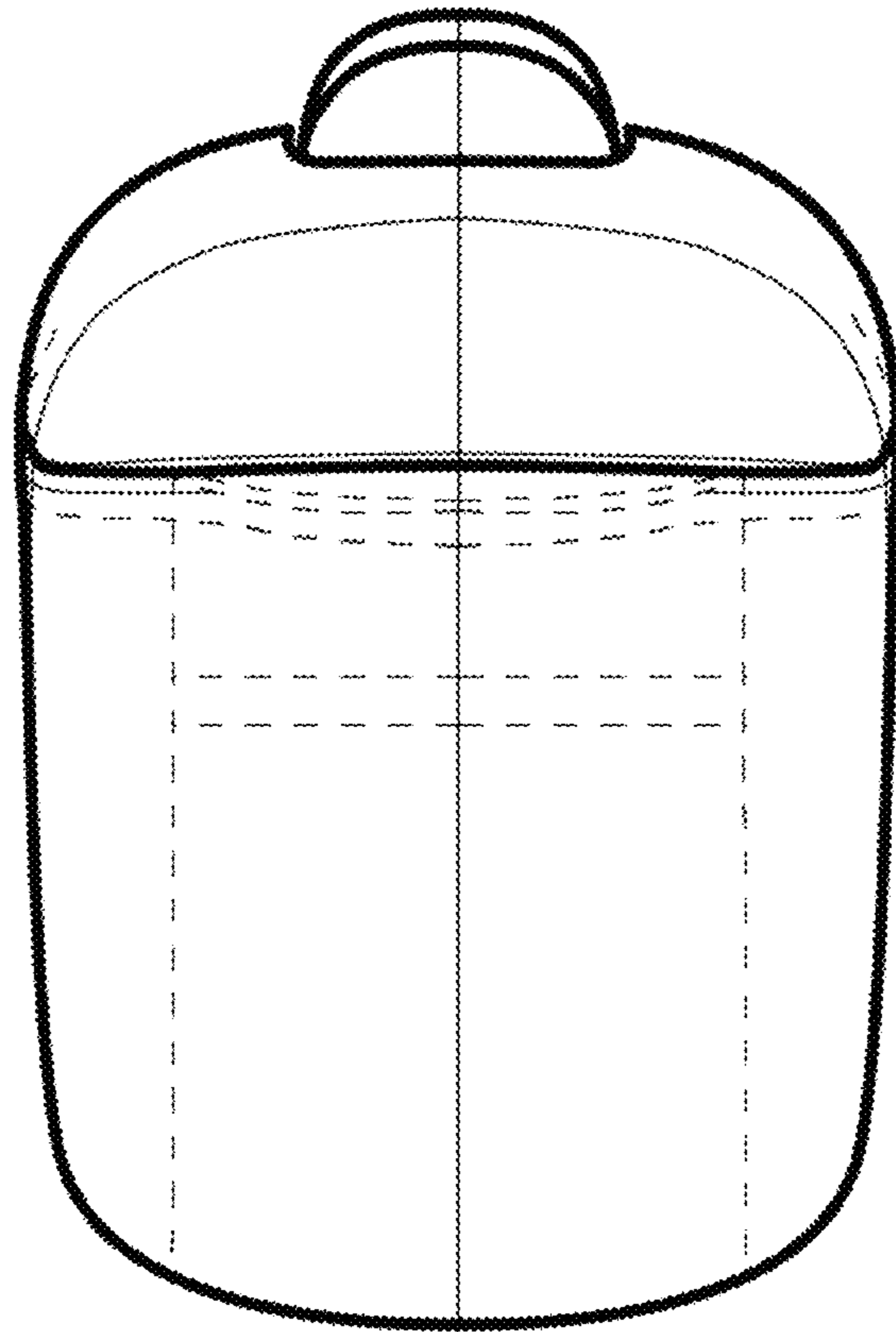
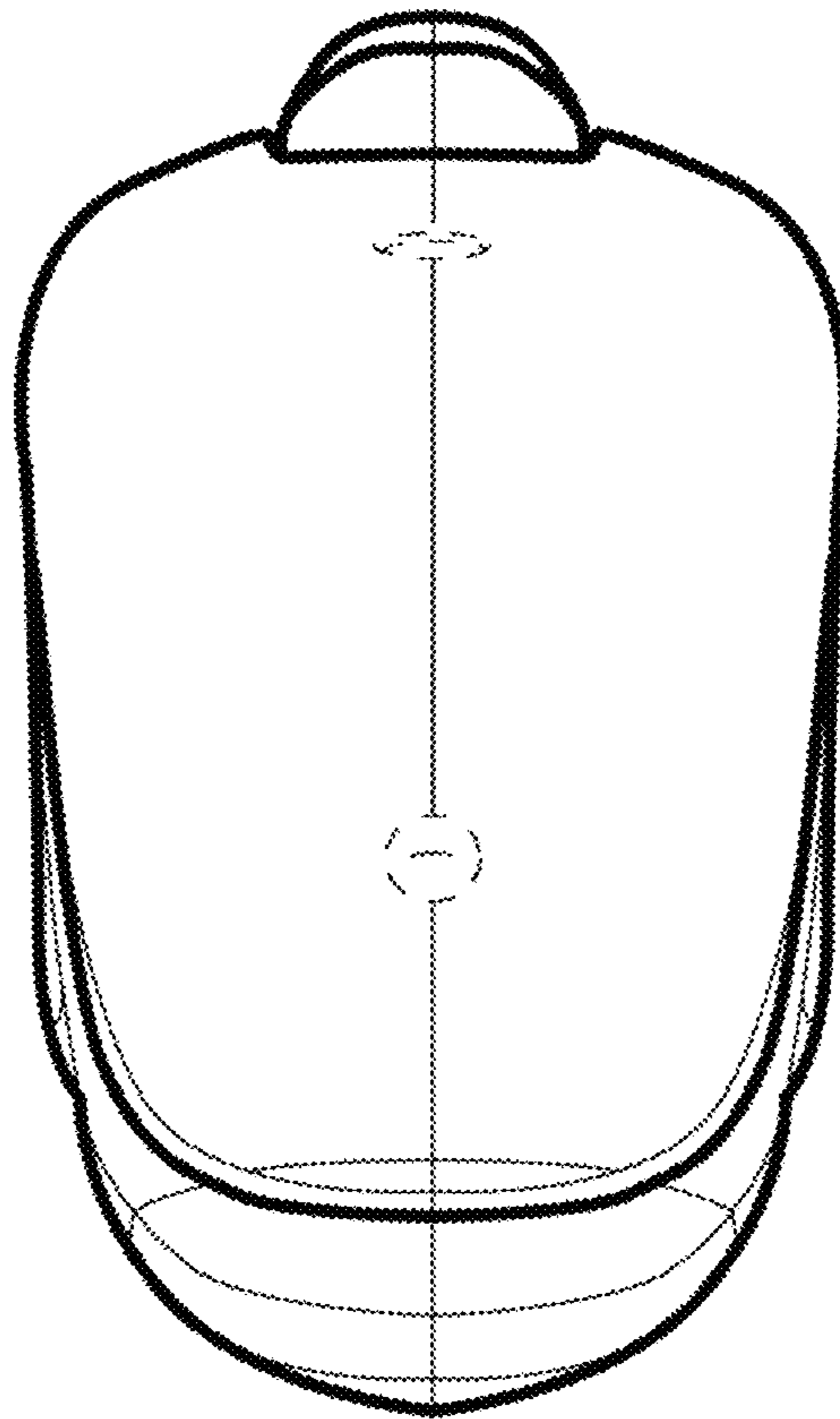

FIG. 3.3

3.4



3.5



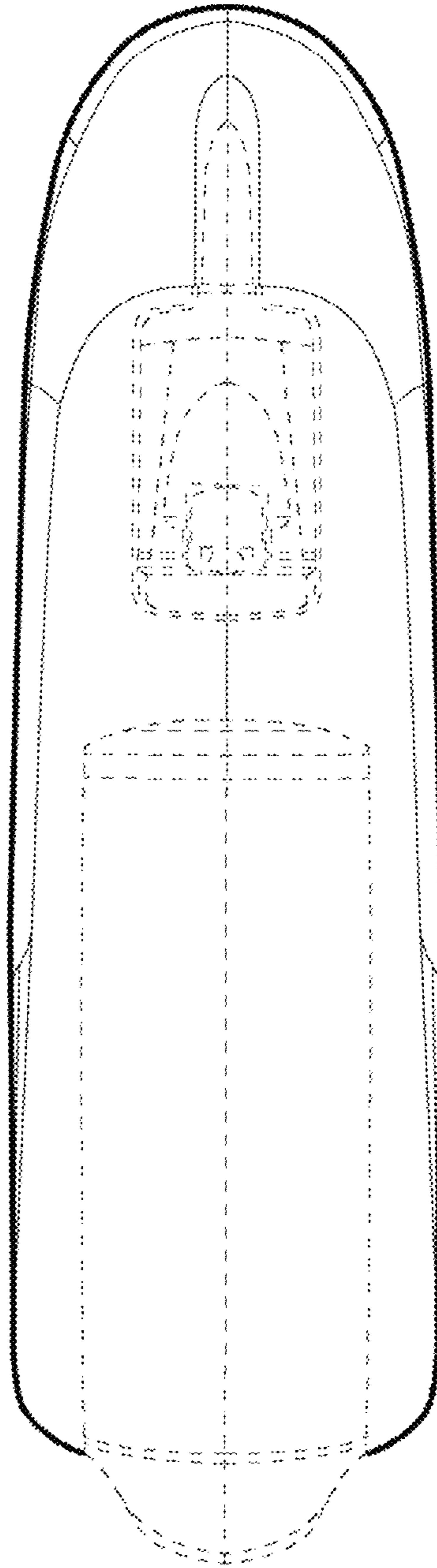

FIG. 3.6

3.7

