

FIG. 7 is a front view thereof.
The broken lines depict portions of the twin dual port network device, which form no part of the claimed design.

1 Claim, 5 Drawing Sheets

(56)

References Cited

U.S. PATENT DOCUMENTS

D705,719 S *	5/2014	Wong	D13/103
D718,288 S *	11/2014	Wang	D14/240
D733,106 S *	6/2015	Frei	D14/240
D791,748 S *	7/2017	Bellows	D14/240
D814,451 S *	4/2018	Shin	D14/242
D815,076 S *	4/2018	Shin	D14/242
D836,619 S *	12/2018	Yokoyama	D14/240
D918,883 S *	5/2021	Liao	D14/242
D922,990 S *	6/2021	Horie	D14/242
D943,563 S *	2/2022	Williamson	D14/240
2016/0029501 A1 *	1/2016	Wu	H05K 5/0204 174/541

FOREIGN PATENT DOCUMENTS

CN	303159738	*	4/2015
CN	303634837	*	4/2016
CN	304494105	*	2/2018
CN	304494126	*	2/2018
CN	304494127	*	2/2018
CN	304578269	*	4/2018
CN	304689554	*	6/2018
CN	306704429	*	7/2021
CN	306704430	*	7/2021
EM	008321434-0001	*	2/2021
EM	008321434-0002	*	2/2021
EM	008321434-0003	*	2/2021
EM	008321434-0004	*	2/2021
JP	D1521329	*	4/2015
KR	301027675.0000	*	10/2019

OTHER PUBLICATIONS

NETGEAR 5 Port PoE, Date First Available: Nov. 11, 2020, [online], [retrieved on Aug. 31, 2021]. Retrieved from Internet, <URL: https://www.amazon.com/dp/B08LRN8BQR/ref=sspa_dk_detail_1?pd_rd_i=B08LRN8BQR&pd_rd_w=IQfn3&pf_rd_p=5d846283-ed3e-4512-a744-a30f97c5d738&pd_rd_wg=Bb4WK&pf_rd_r=DENKGFZ5XZN3R2SJG7&pd_rd_r=f867ca8c-6c8b-4852-ae0-7ca41552c9bc&spLa=ZW5jenlwdGVkUXVhbGlmaWVyPUEwWI A4SEswN1dCSDZPJmVuY3J5cHRIZEikPUEwNjI0ODEwMlhJNzdlMFpSR1c3TCZlbnNyeXB0ZWRBZEikPUEwNTI5ODQzMtDZTDBEQUJQS0xYWiz3aWRnZXROYW1IPXNwX2RldGFpbF90aGVtYXRpYyZhY3Rpb249Y2xpY2tSZWRpcmVjdCZkb05vdExvZ0NsaWNrPXRydWU&th=1>.*

KST-RJ45C6A-P, Date Available: Oct. 26, 2017, [online], [retrieved on Aug. 31, 2021]. Retrieved from Internet, <URL: <https://shop.sommercable.com/en/Plug-Connectors/RJ45-CAT-FIBER/RJ45-CAT-6-8-pol-KST-RJ45C6A-P.html>>.*

Internet Publication by Cable Matters, Date Available: Feb. 18, 2021, [online], [retrieved on Aug. 31, 2021]. Retrieved from Internet, <URL: <https://www.youtube.com/watch?v=mQH8m-uFQ3Y>>.*

Rj45 1x4 Quad Port LP, Date not given, [online], [retrieved on Aug. 31, 2021]. Retrieved from Internet, <URL: <http://www.rj45-modularjack.com/sale-8076076-rj45-1x4-quad-port-lpj46404aenl-jx80-0033nl-magnetics-ethernet-jack-10-100mbps.html>>.*

Newegg.com, [Online], "5 Port POE Switch Gigabit 4 Port Gigabit POE + 1 Gigabit UPLink Ethernet Switch Wall Mountable 101001000 Mbps External Power Supply 60W 1 Pack," available on or before Oct. 6, 2021, [Retrieved on Oct. 6, 2021], retrieved from: URL <<https://www.newegg.com/p/0XP-00AE-00046?Item=9SIASDFD763077&Tpk=9SIASDFD763077>>, 3 pages.

Newegg.com, [Online], "Analog Telephone Adapter," available on or before Oct. 6, 2021, [Retrieved on Oct. 6, 2021], retrieved from: URL <<https://www.newegg.com/grandstream-gs-ht802-adapter/p/0Y1-003X-00046?Item=9SIA2F86R65837&Tpk=9SIA2F86R65837>>, 6 pages.

* cited by examiner

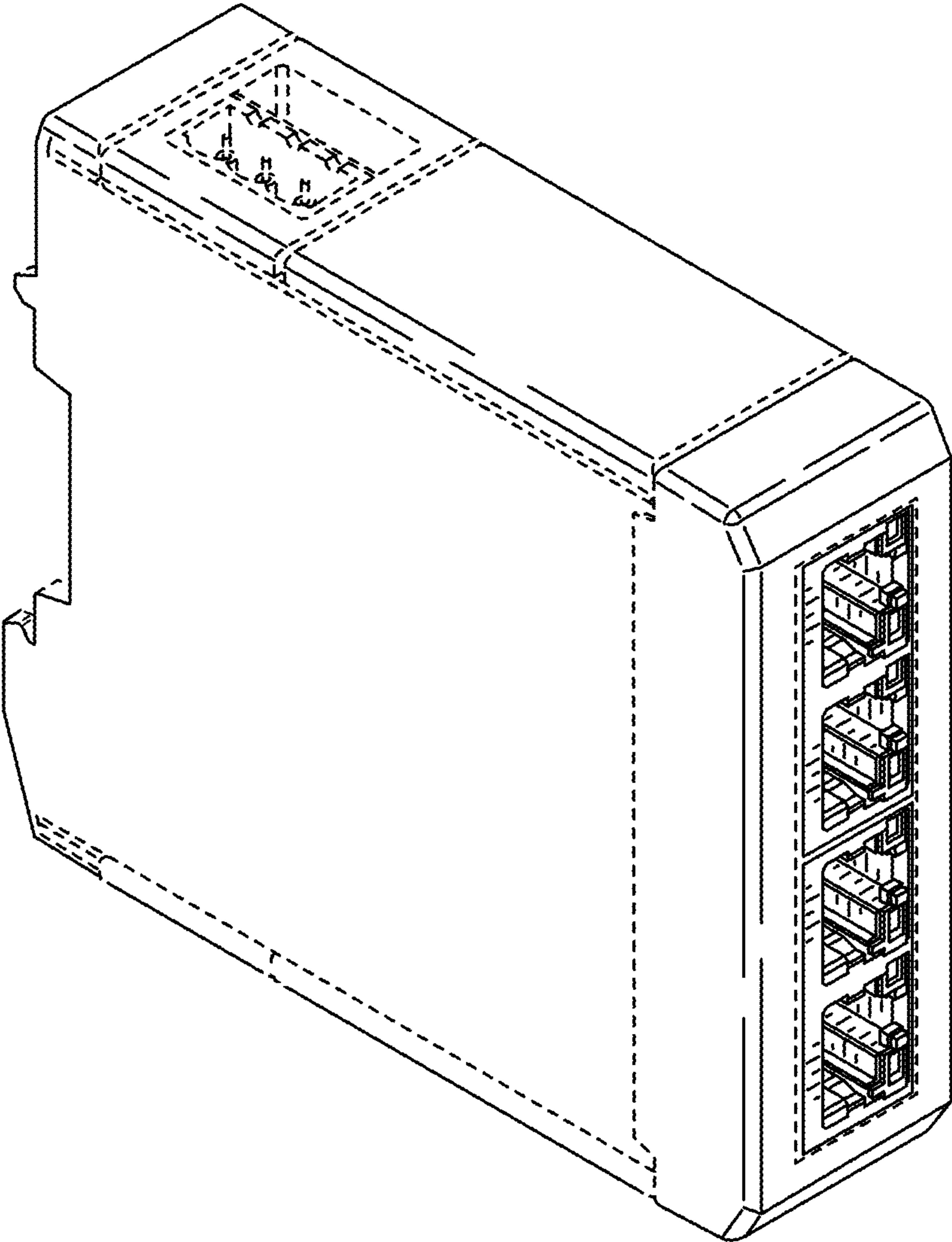

FIG. 1

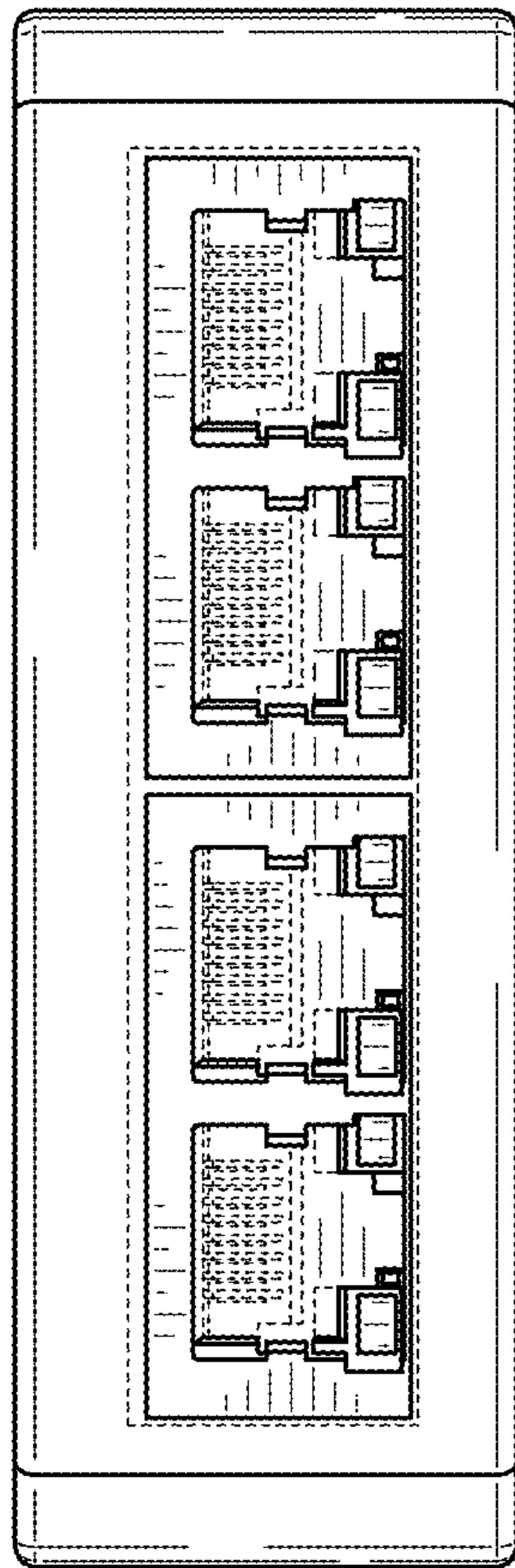

FIG. 2

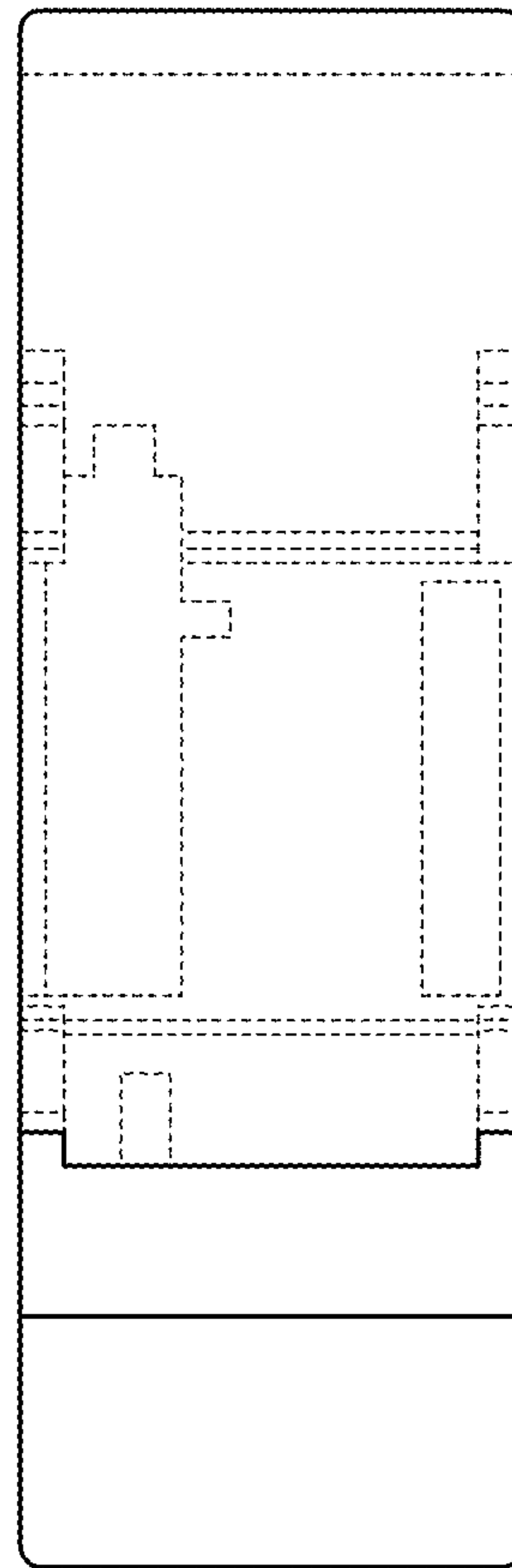

FIG. 3

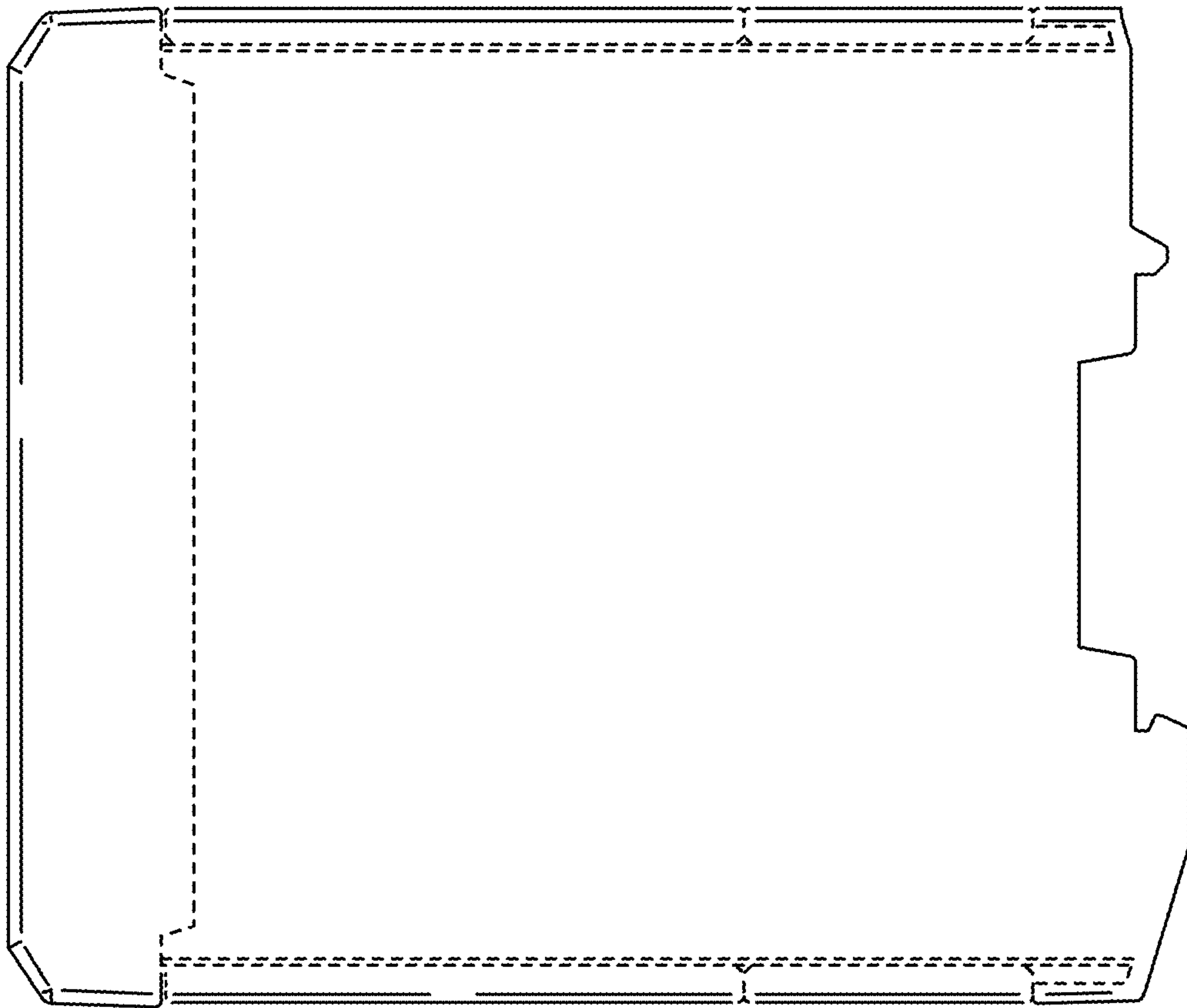

FIG. 4

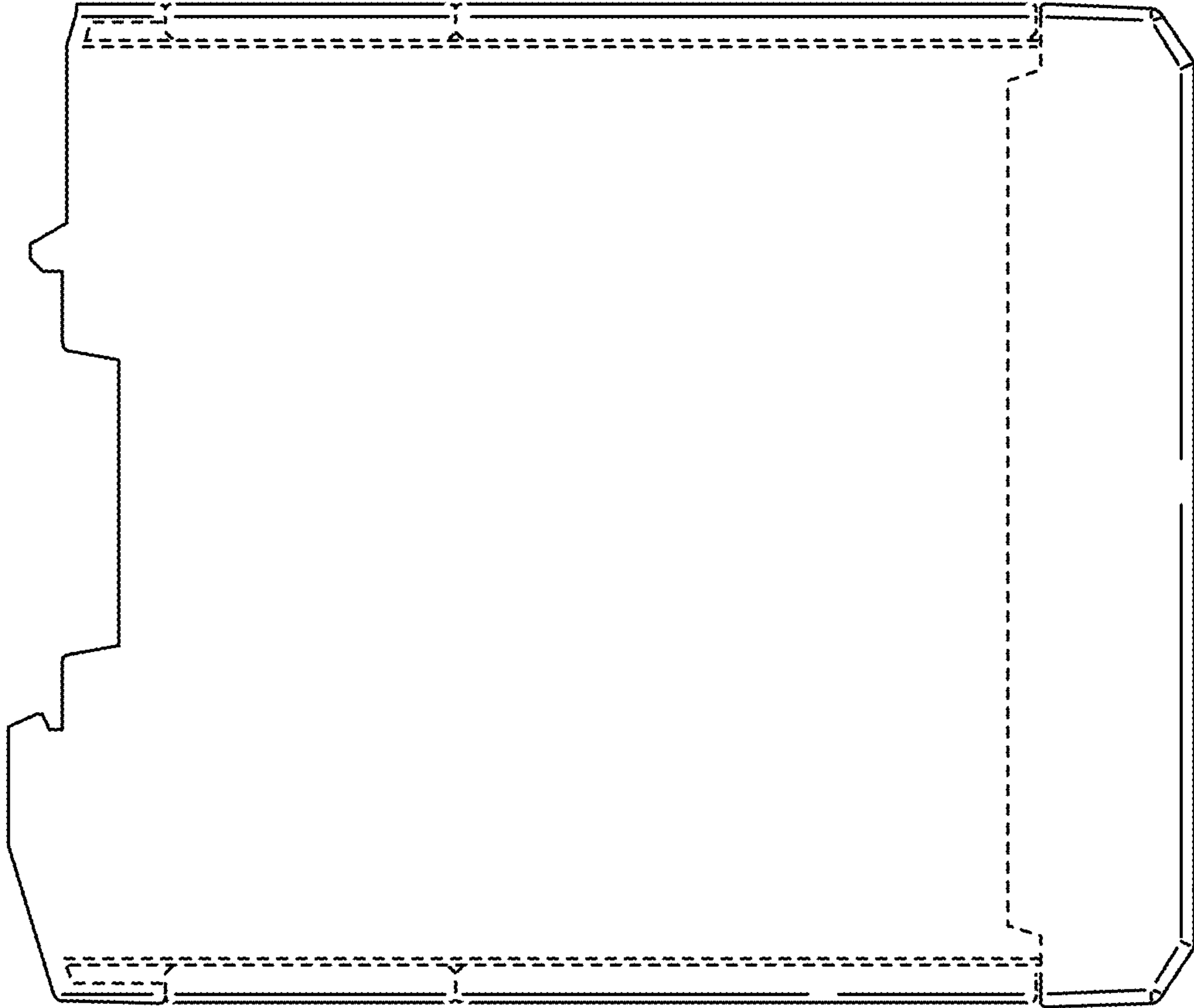

FIG. 5

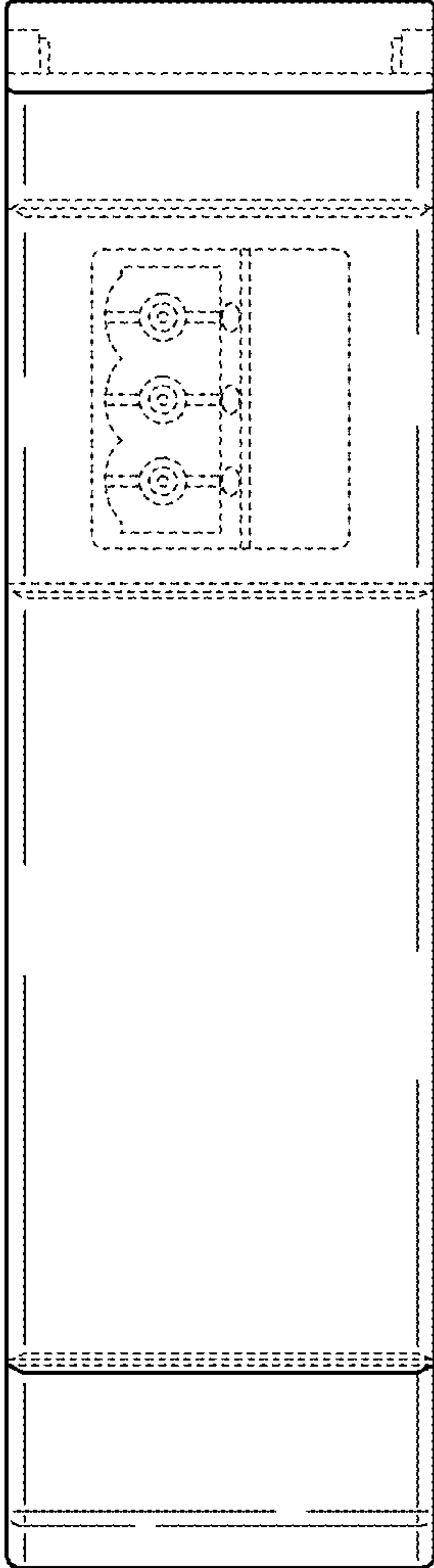

FIG. 6

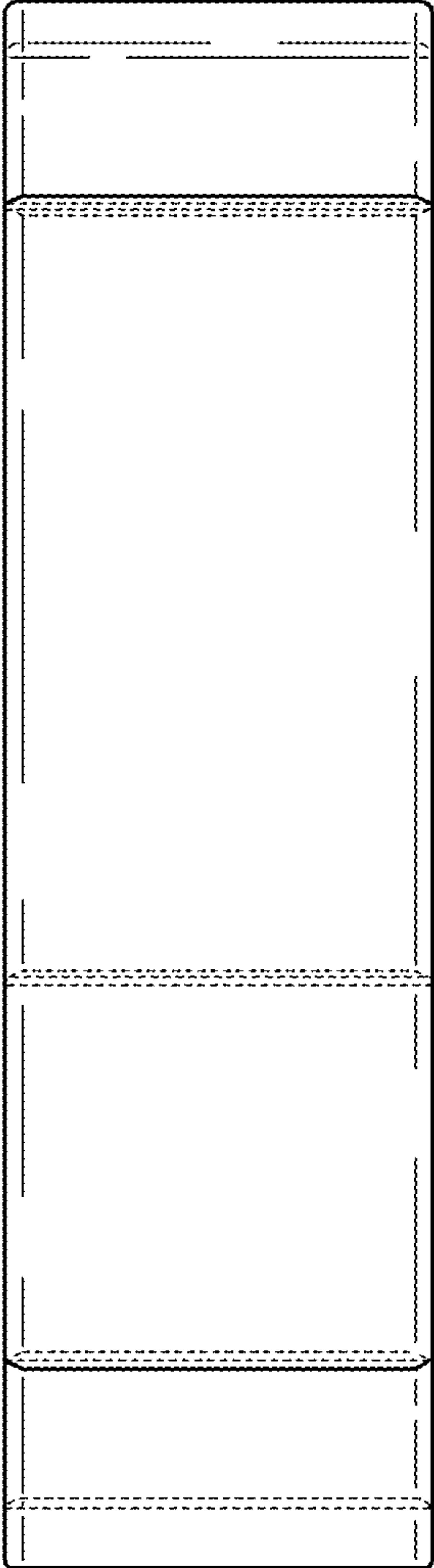

FIG. 7