



US00D958082S

(12) **United States Design Patent** (10) **Patent No.:** **US D958,082 S**
Lin (45) **Date of Patent:** **** Jul. 19, 2022**

(54) **SOCKET**

(71) Applicant: **Dongguan Wontravel Electric Co., Ltd.**, Guangdong (CN)

(72) Inventor: **Liangguan Lin**, Guangdong (CN)

(**) Term: **15 Years**

(21) Appl. No.: **29/769,178**

(22) Filed: **Feb. 4, 2021**

(30) **Foreign Application Priority Data**

Aug. 5, 2020 (CN) 202030437577.5

(51) **LOC (13) Cl.** **13-03**

(52) **U.S. Cl.**
USPC **D13/139.7**

(58) **Field of Classification Search**

USPC D13/137.1, 137.2, 137.3, 137.4, 138.1, D13/138.2, 139.1, 139.2, 139.3, 139.4, D13/139.5, 139.6, 139.7, 139.8, 103, 107, D13/108, 110, 119, 123, 133, 145, 152, D13/153, 154, 156, 158, 160, 162, 177, D13/184, 199

CPC H01R 13/00; H01R 13/03; H01R 13/04; H01R 13/10; H01R 13/35; H01R 13/44; H01R 13/453; H01R 13/4534; H01R 13/502; H01R 13/514; H01R 13/631; H01R 13/639; H01R 13/6633; H01R 13/6666; H01R 13/6675; H01R 13/7135; H01R 31/02; H01R 31/06; H01R 31/065

See application file for complete search history.

(56) **References Cited**

U.S. PATENT DOCUMENTS

D443,589 S * 6/2001 Tong D13/137.2
D734,724 S * 7/2015 Faul D13/137.4
D834,519 S * 11/2018 Faul D13/137.2
D871,344 S * 12/2019 Lyu D13/139.8

D878,299 S * 3/2020 Lyu D13/139.8
D881,821 S * 4/2020 Lyu D13/139.8
D883,934 S * 5/2020 Yu D13/139.8
D885,345 S * 5/2020 Chen D13/139.8

(Continued)

FOREIGN PATENT DOCUMENTS

GB 6090783 * 5/2020
GB 6097887 * 8/2020

(Continued)

OTHER PUBLICATIONS

“Power Strip with USB, Tessan Desktop 5 Ft Extension Cord Flat Plug with 6 Widely Spaced Outlets, Built-in 1700J Surge Protector for Home and Office Accessories, Black”, first available Sep. 26, 2018. Amazon.com [https://www.amazon.com/dp/B07HNWKS3S] (Year: 2018).*

(Continued)

Primary Examiner — Rosemary K Tarcza
Assistant Examiner — Seth David Kumpf
(74) *Attorney, Agent, or Firm* — Prakash Nama; Global IP Services, PLLC

(57) **CLAIM**

The ornamental design for a socket, as shown.

DESCRIPTION

FIG. 1 is a front elevational view of a socket showing my new design;
FIG. 2 is a rear elevational view thereof;
FIG. 3 is a left side view thereof;
FIG. 4 is a right side view thereof;
FIG. 5 is a top plan view thereof;
FIG. 6 is a bottom plan view thereof;
FIG. 7 is a perspective view thereof;
FIG. 8 is a second perspective view thereof; and,
FIG. 9 is a third perspective view thereof.

1 Claim, 8 Drawing Sheets

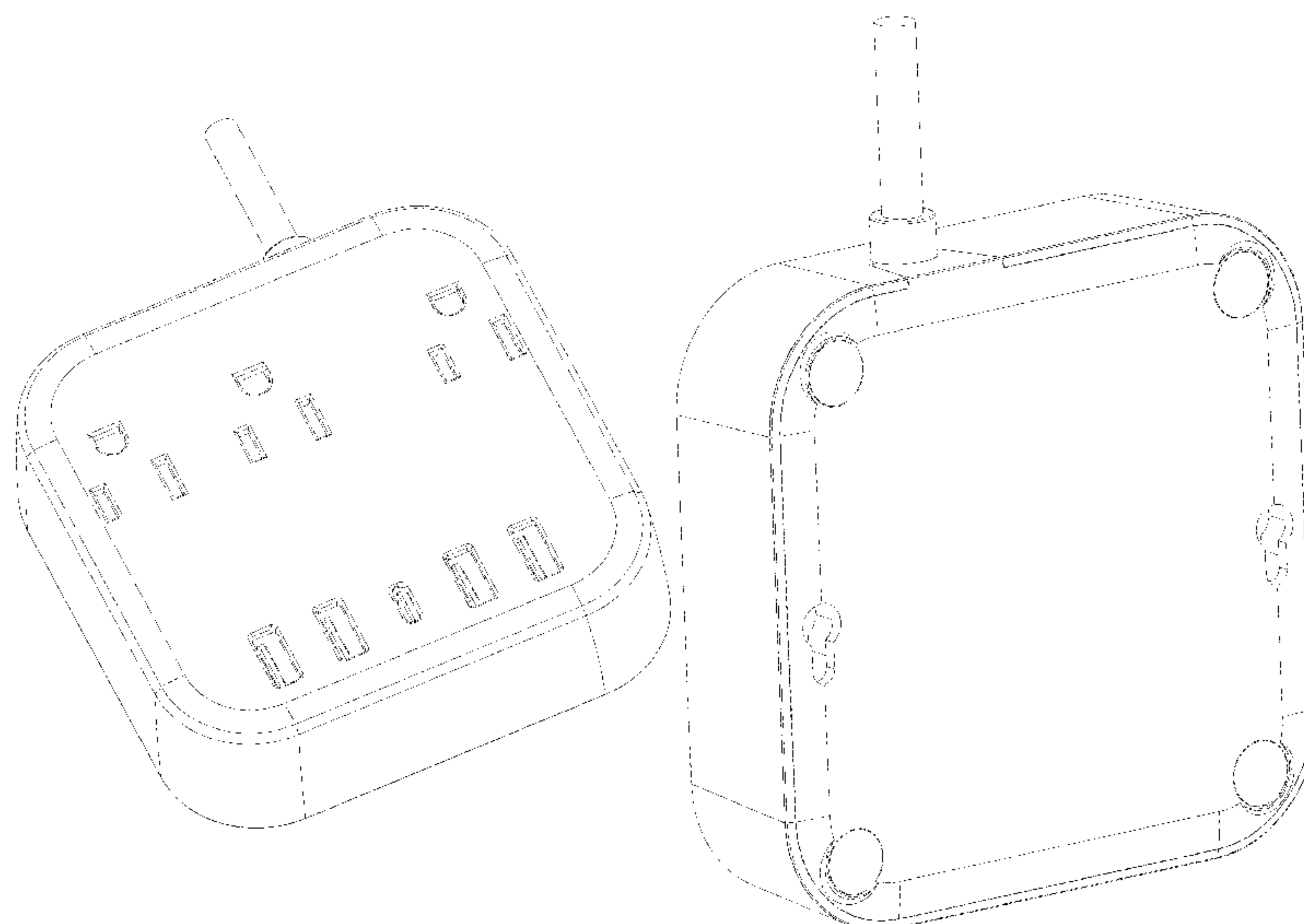

(56)

References Cited

U.S. PATENT DOCUMENTS

D900,749 S * 11/2020 Bao D13/137.2
D903,600 S * 12/2020 Tseng D13/139.7
D916,028 S * 4/2021 Yu D13/139.8
D930,946 S * 9/2021 Chen D1/100

FOREIGN PATENT DOCUMENTS

GB 6127083 * 3/2021
GB 6127084 * 3/2021

OTHER PUBLICATIONS

“Power Strip with USB Ports, KOOPER Surge Protector Flat Plug with 4 Widely Spaced Outlets 4 USB Charger 4.5A, Wall Mountable 4.5 FT Extension Cord Compact for Travel Desk Home Dorm Room Essentials”, first available Sep. 24, 2021. Amazon.com [<https://www.amazon.com/dp/B09D7L5L9W>] (Year: 2021).*

“POWRUI Surge Protector, USB Wall Charger with 2 USB Charging Ports(Smart 2.4A Total), 6-Outlet Extender and Top Phone Holder for Your Cell Phone, White, ETL Listed”, first available May 29, 2018. Amazon.com [<https://www.amazon.com/dp/B07DCRVBYX>] (Year: 2018).*

“Handsonic Power Strip, Mountable Flat Plug Extension Cord with 4 Outlets, 3 USB-A, 1 USB-C, 5 ft Cord, Compact Size Charging Station for Home, Office, Dorm Essentials, Desktop, Travel and Cruise Ship”, first available Aug. 7, 2020. Amazon.com [<https://www.amazon.com/dp/B08FDBM2FK>] (Year: 2020).*

* cited by examiner

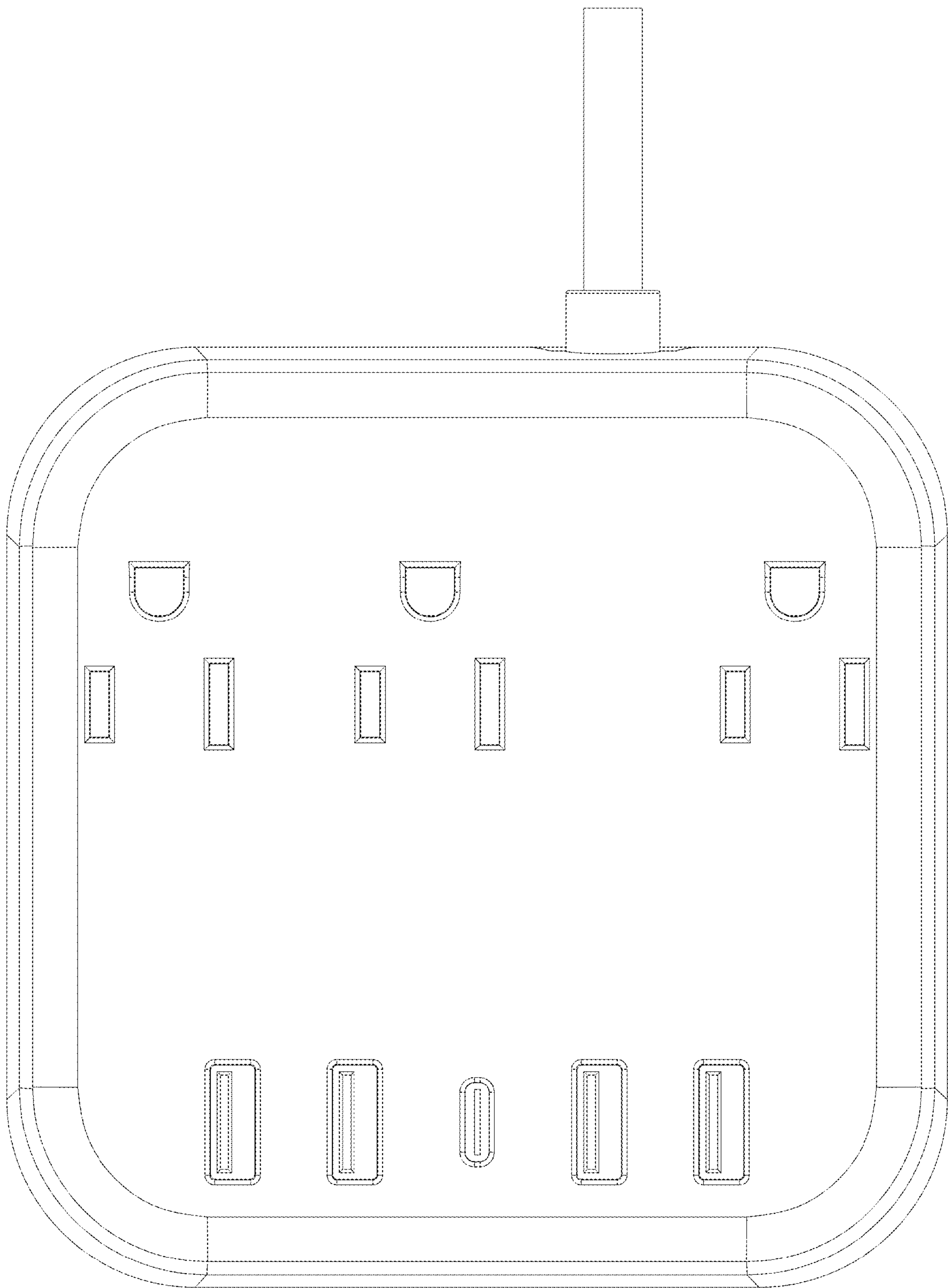

FIG. 1

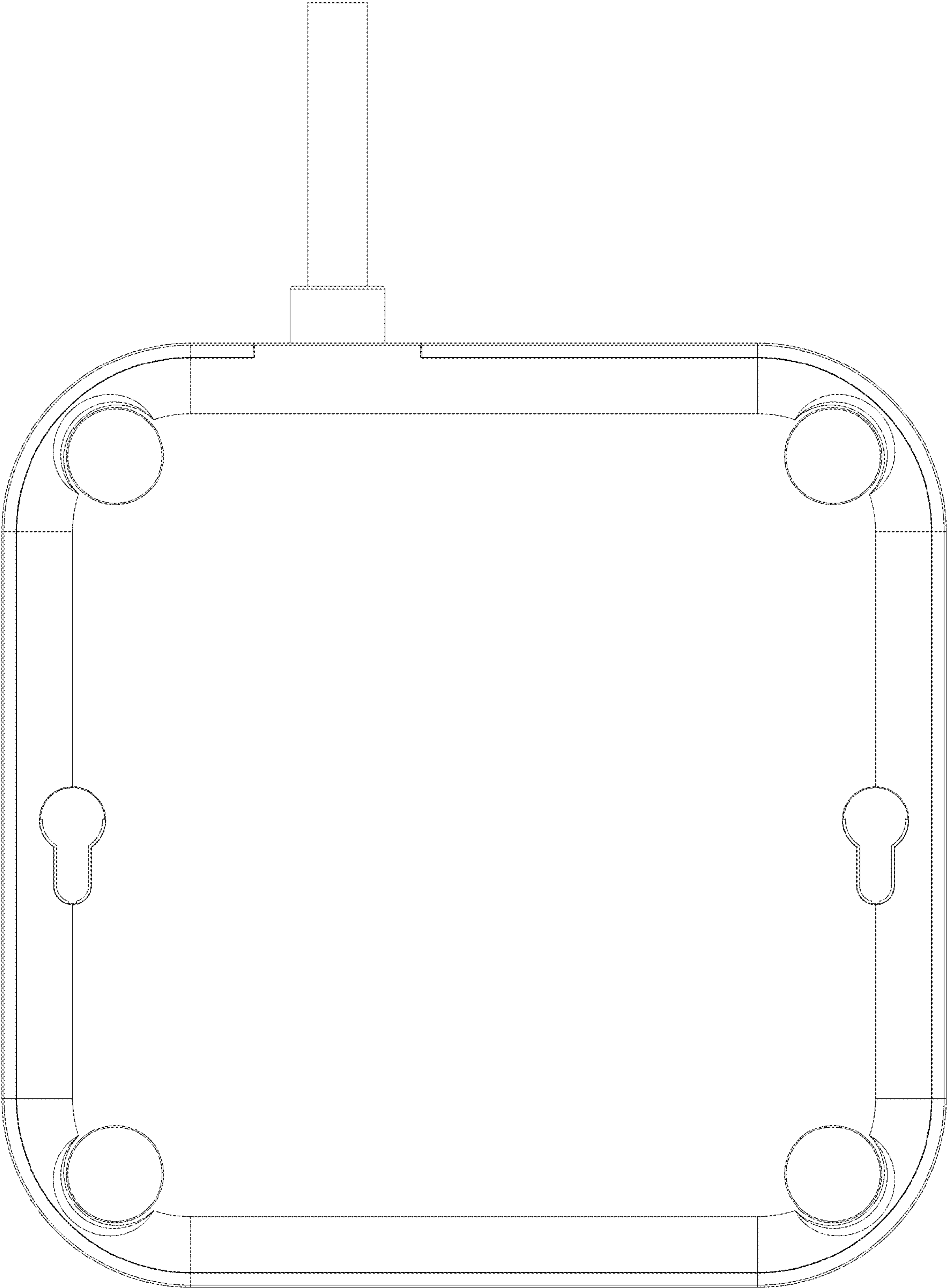

FIG. 2

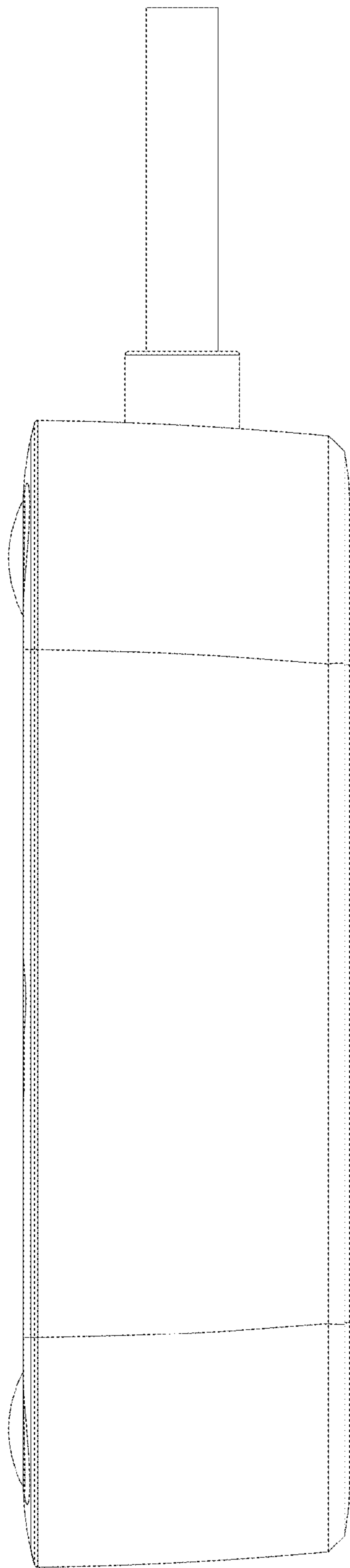

FIG. 3

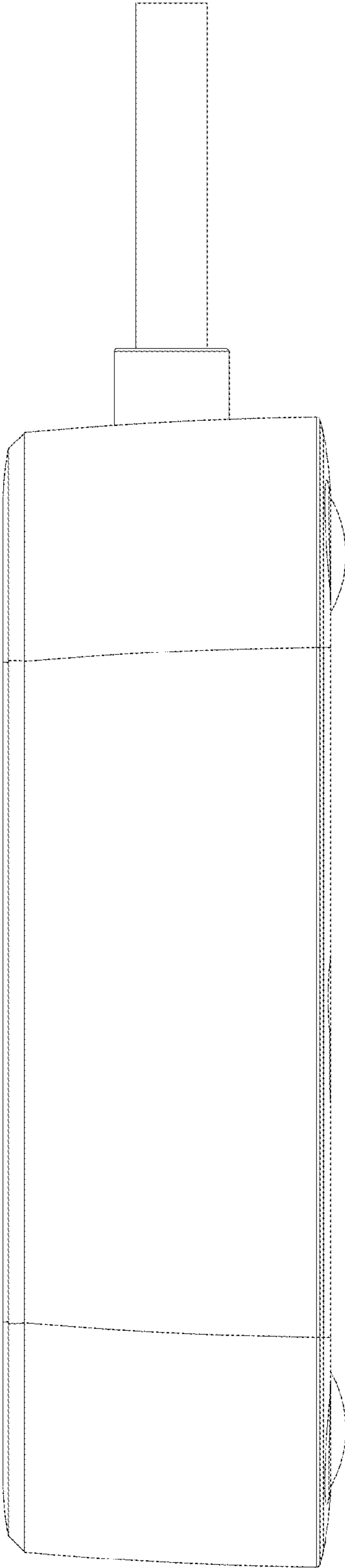

FIG. 4

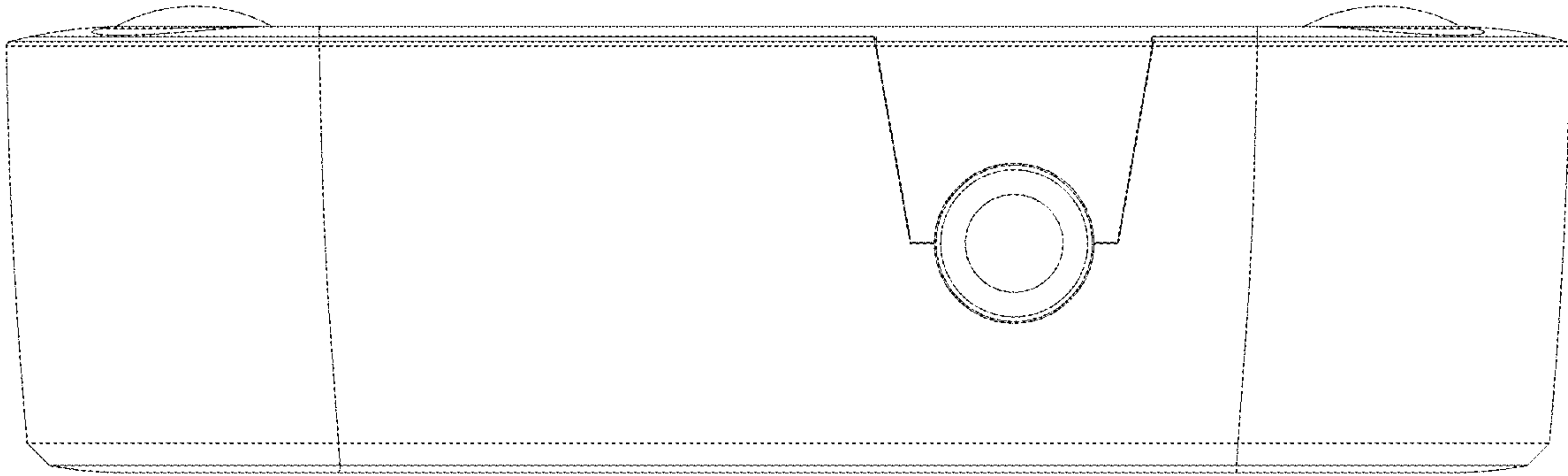

FIG. 5

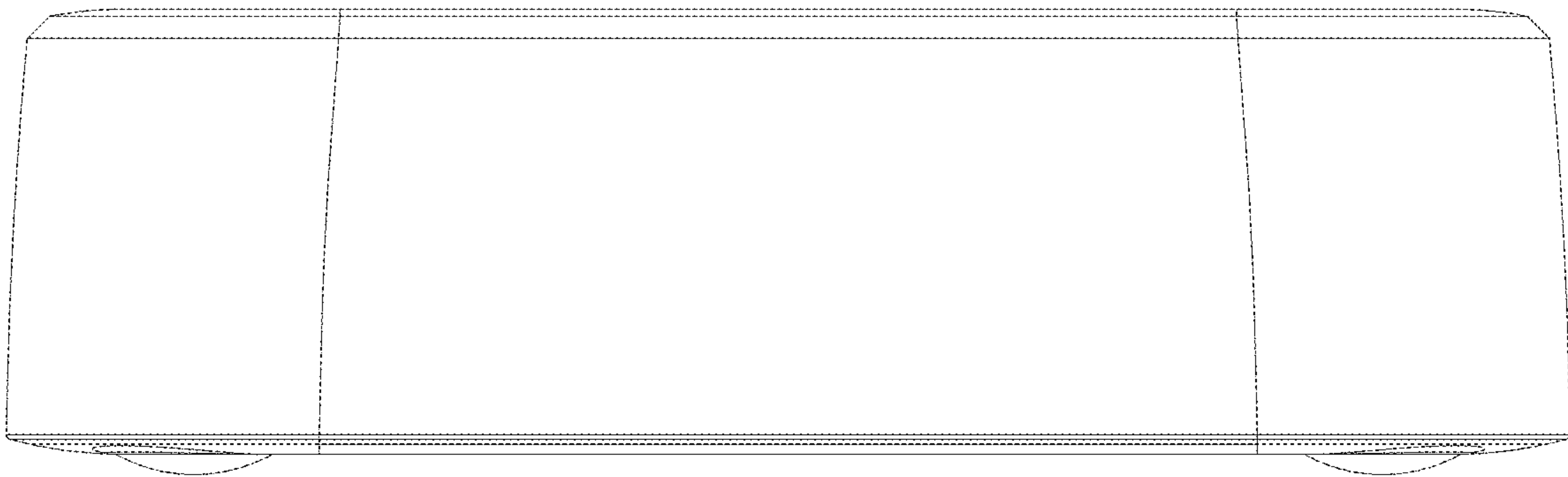

FIG. 6

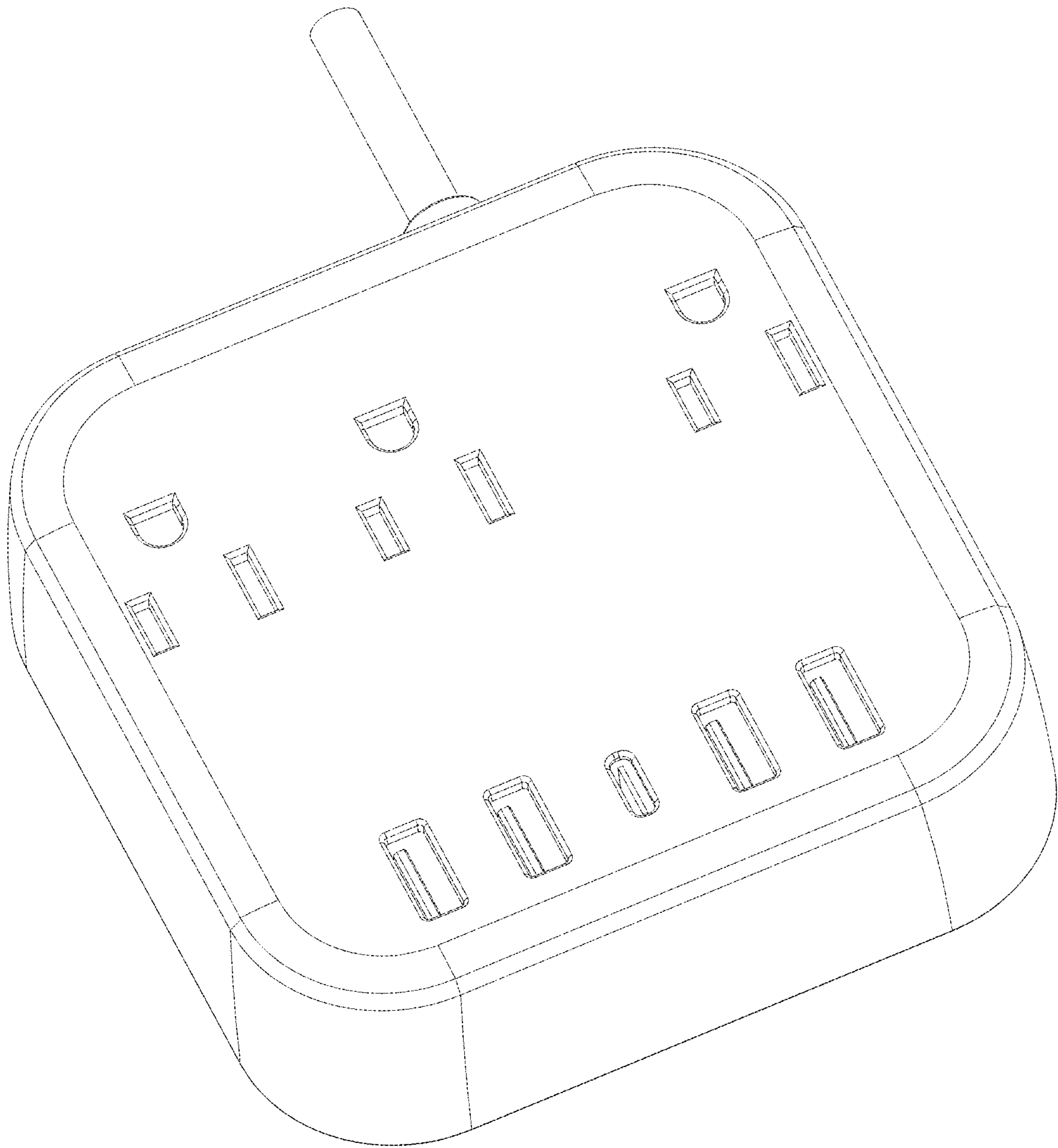

FIG. 7



FIG. 8

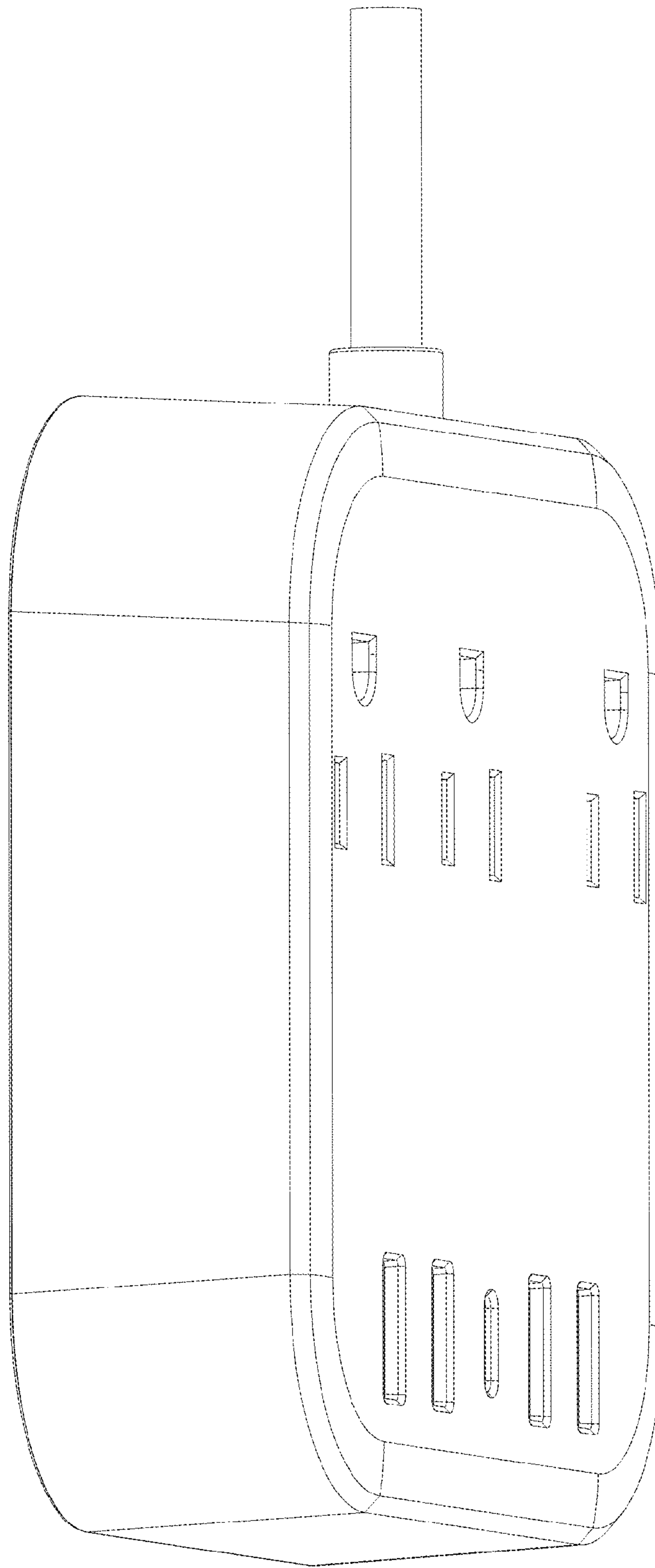

FIG. 9