



US00D958075S

(12) **United States Design Patent** (10) **Patent No.:** **US D958,075 S**
Nook et al. (45) **Date of Patent:** **** Jul. 19, 2022**

- (54) **BATTERY CLAMP**
- (71) Applicant: **THE NOCO COMPANY**, Glenwillow, OH (US)
- (72) Inventors: **Jonathan Lewis Nook**, Gates Mills, OH (US); **William Knight Nook**, Shaker Heights, OH (US); **James Richard Stanfield**, Glendale, AZ (US); **Derek Michael Underhill**, Tempe, AZ (US)
- (73) Assignee: **THE NOCO COMPANY**, Glenwillow, OH (US)
- (*) Notice: This patent is subject to a terminal disclaimer.
- (**) Term: **15 Years**

D597,029	S	*	7/2009	Li	D13/120
D625,265	S	*	10/2010	DuMelle	D13/120
D689,020	S	*	9/2013	Demirjian	D13/120
D726,109	S	*	4/2015	Nook	D13/120
D735,665	S	*	8/2015	Nook	D13/120
D889,411	S	*	7/2020	Wang	D13/120
2020/0335887	A1	*	10/2020	Nook	H01R 11/282

- (21) Appl. No.: **29/756,071**
- (22) Filed: **Oct. 26, 2020**

Related U.S. Application Data

- (63) Continuation of application No. 29/665,148, filed on Oct. 1, 2018.
- (51) **LOC (13) Cl.** **13-02**
- (52) **U.S. Cl.**
USPC **D13/120**
- (58) **Field of Classification Search**
USPC D13/118, 119, 120, 103, 148, 149, 151, D13/199; D12/223
CPC H01R 11/24; H01R 11/281; H01R 11/283
See application file for complete search history.

(56) **References Cited**

U.S. PATENT DOCUMENTS

D258,818	S	*	4/1981	Johnson	D13/120
D304,928	S	*	12/1989	Mize	D13/120

OTHER PUBLICATIONS

Noco.com. "GBC003 HD Precision Boost Battery Clamps." Publication: Jan. 2021. <<https://no.co/gbc003>> (Year: 2021).*

* cited by examiner

Primary Examiner — Jennifer O King
(74) *Attorney, Agent, or Firm* — Vorys, Sater, Seymour & Pease LLP; William Klima

(57) **CLAIM**

The ornamental design for a battery clamp, as shown and described.

DESCRIPTION

FIG. 1 is a front perspective view of a new design for a battery clamp;
FIG. 2 is a front elevational view thereof;
FIG. 3 is a rear elevational view thereof;
FIG. 4 is a left side elevational view thereof;
FIG. 5 is a right side elevational view thereof;
FIG. 6 is a top plan view thereof; and,
FIG. 7 is a bottom plan view thereof.
The broken lines shown represent portions of the battery clamp that form no part of the claimed design.

1 Claim, 7 Drawing Sheets

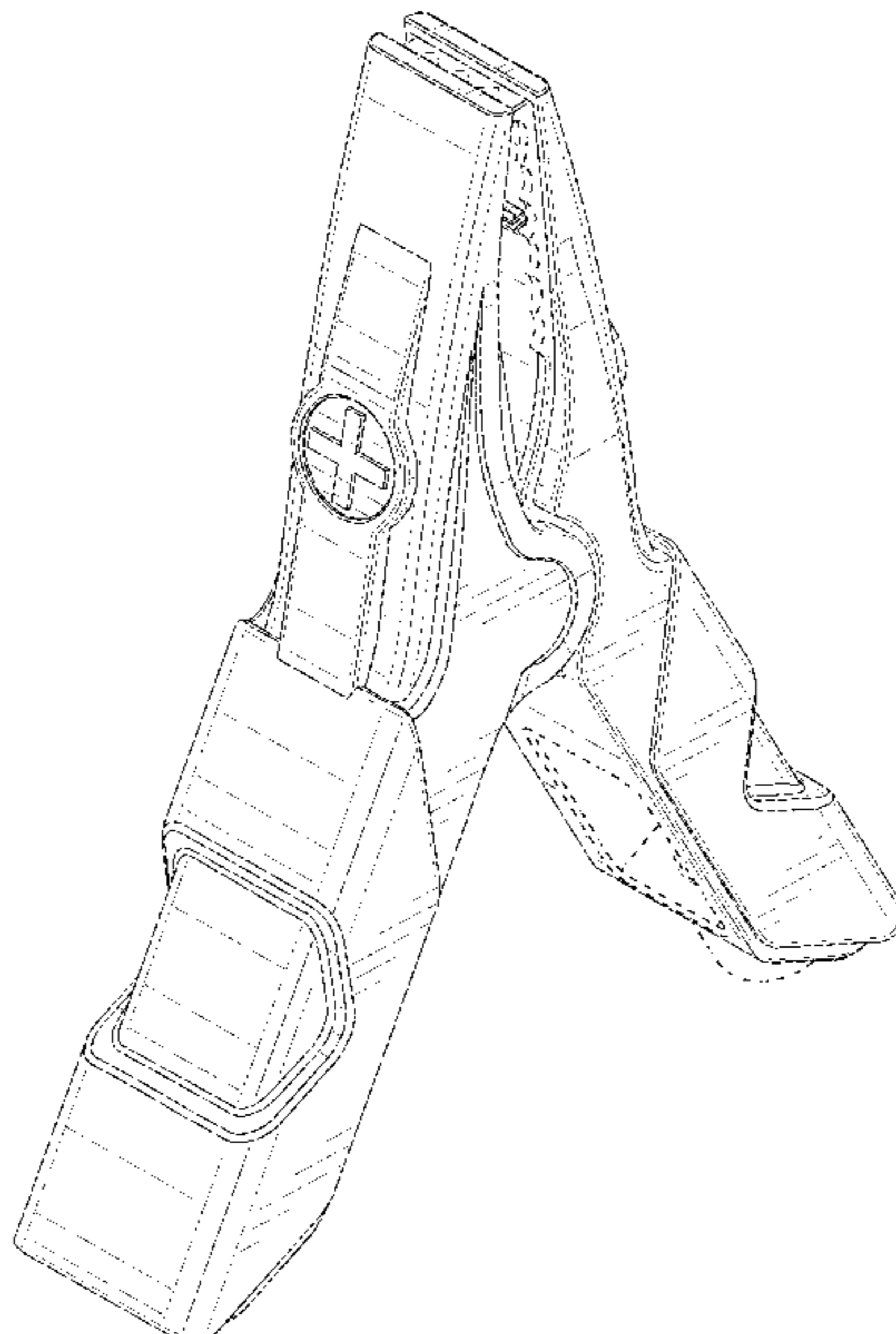

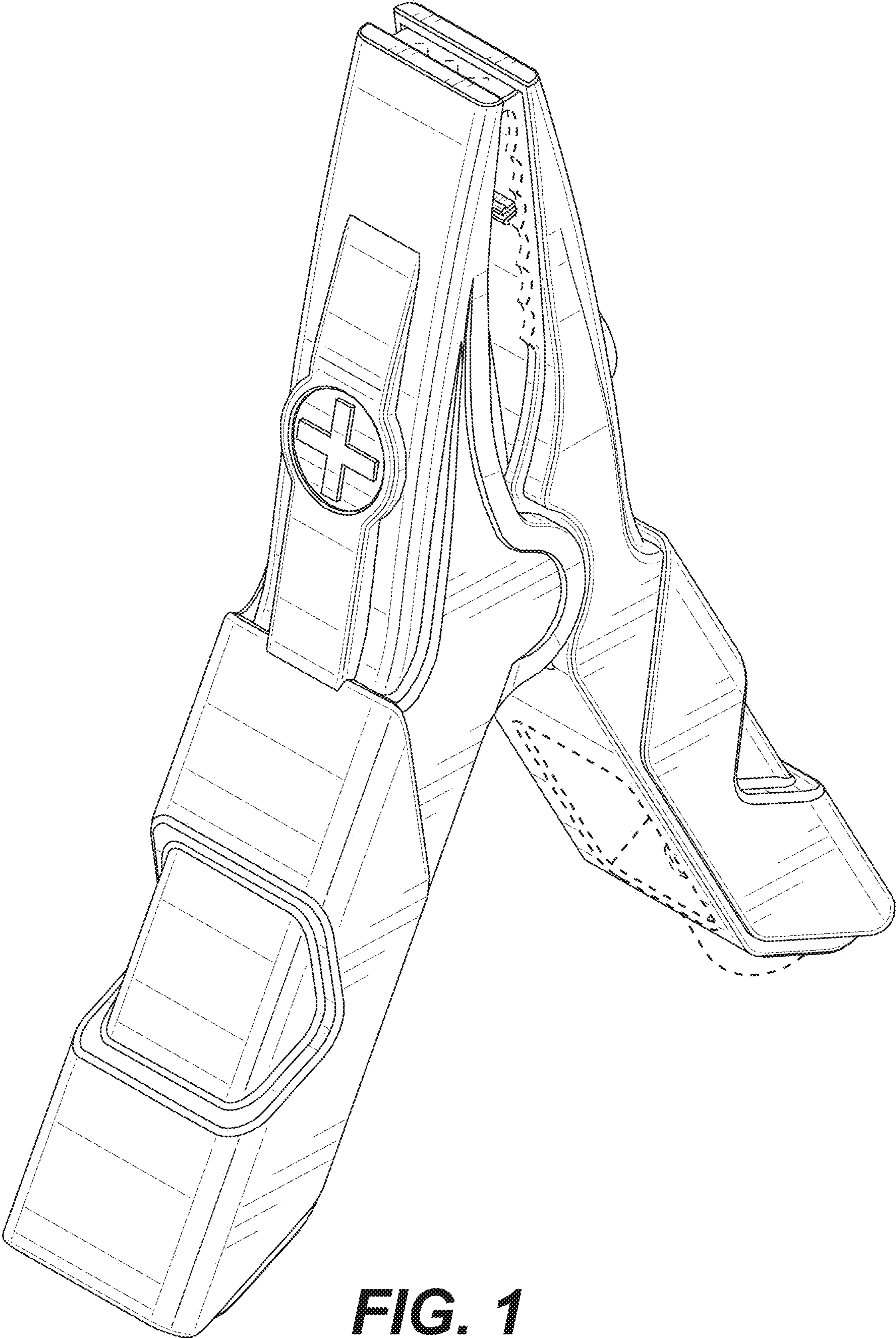

FIG. 1

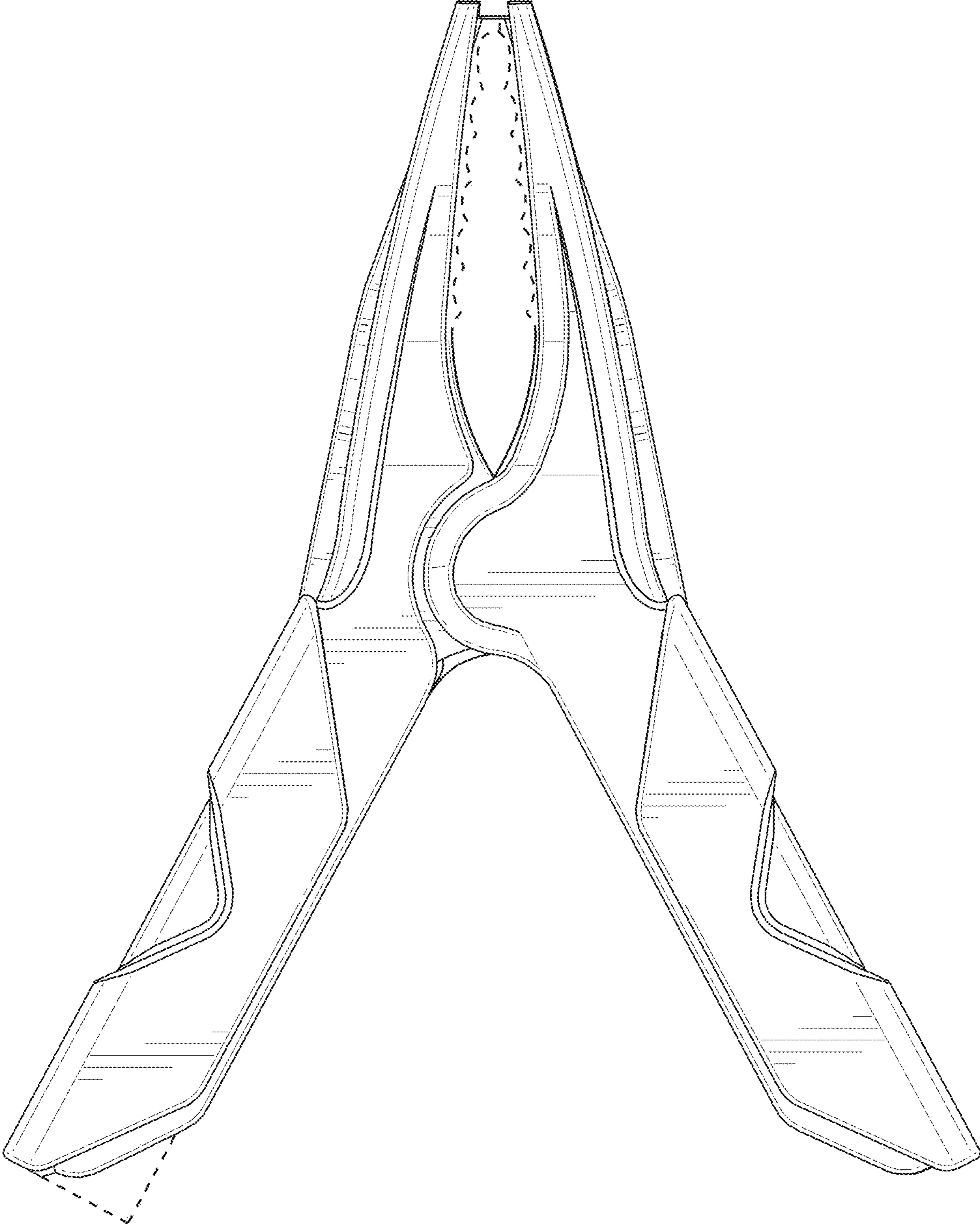

FIG. 2

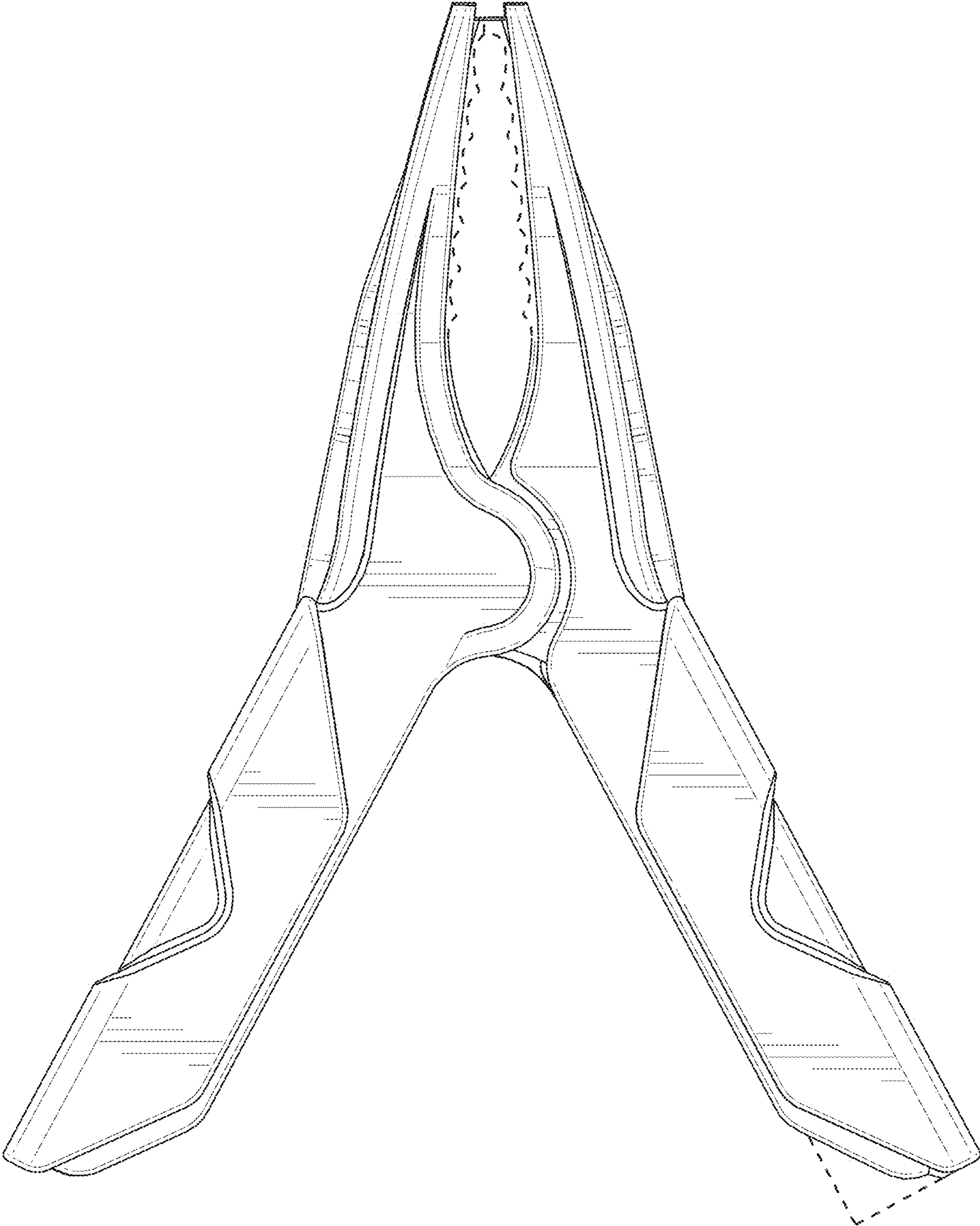

FIG. 3

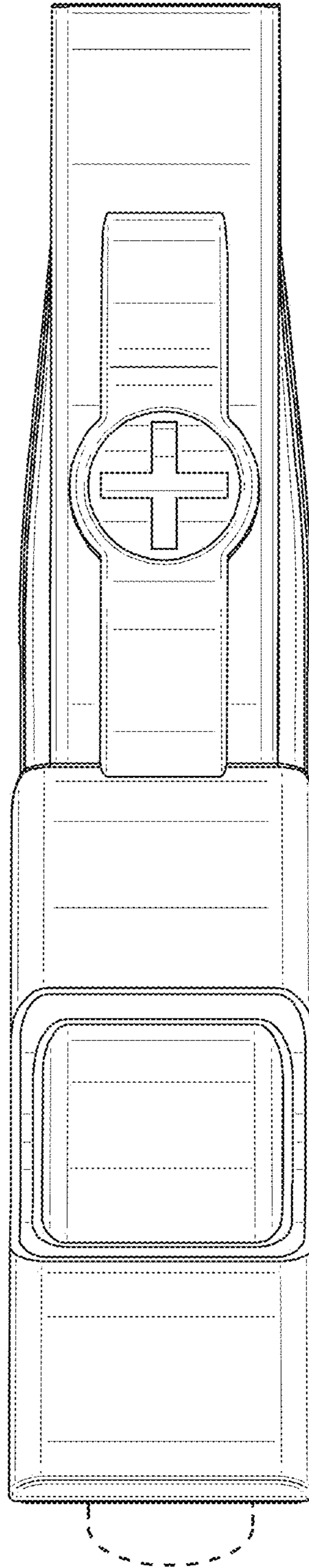

FIG. 4

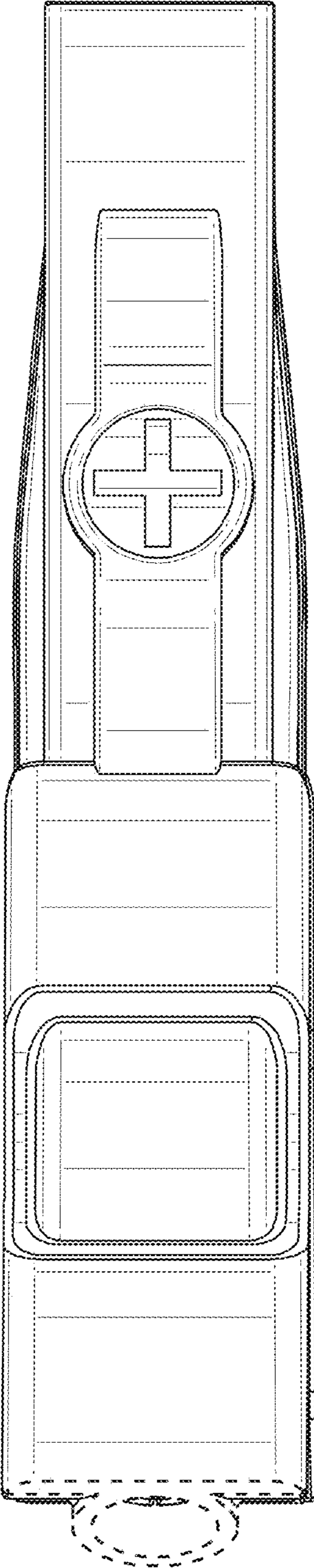

FIG. 5

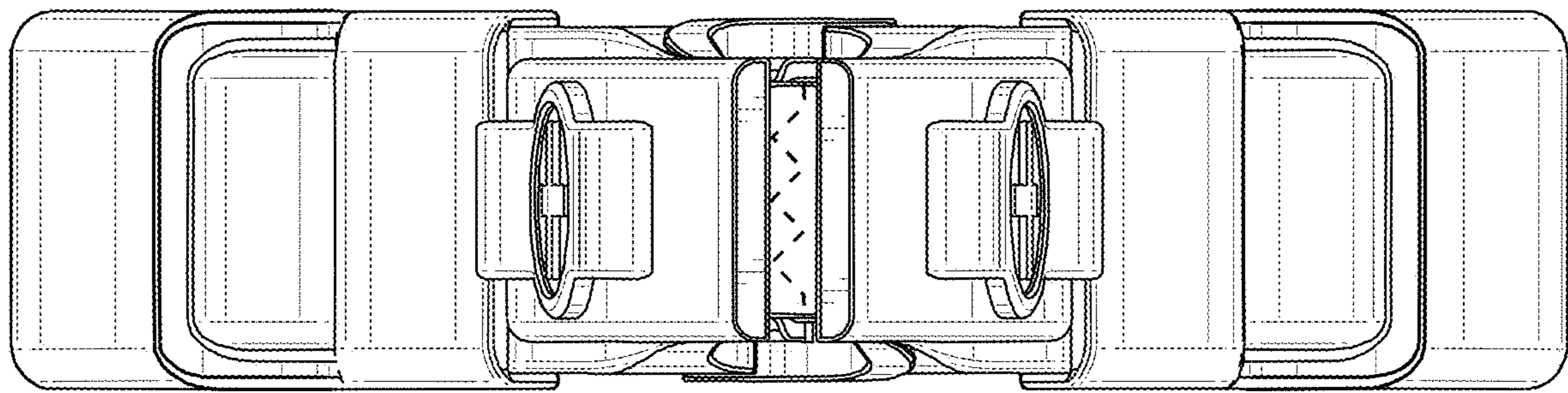

FIG. 6

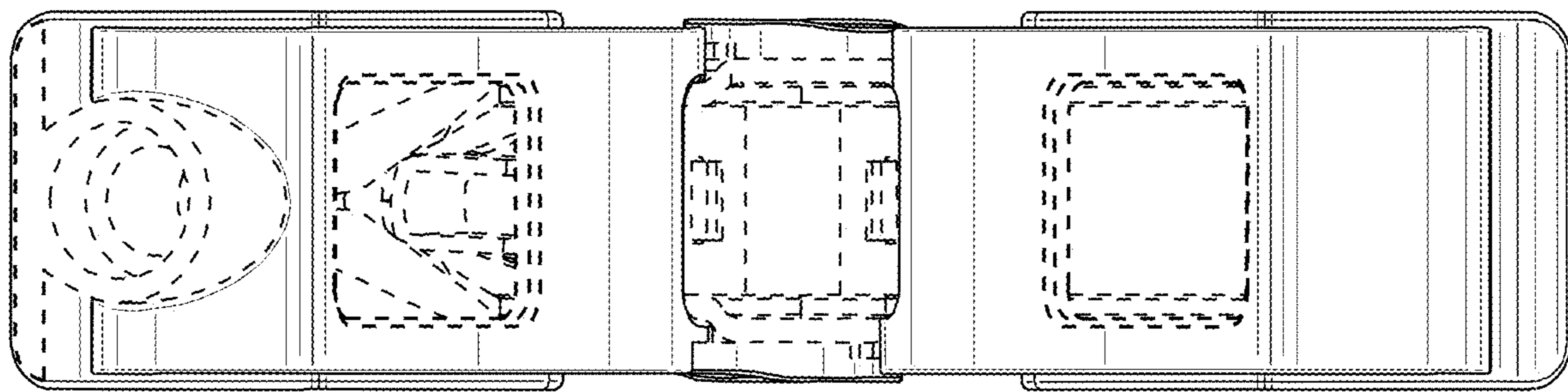

FIG. 7