



US00D958064S

(12) **United States Design Patent** (10) **Patent No.:** **US D958,064 S**
Finocchiaro (45) **Date of Patent:** **** Jul. 19, 2022**

(54) **JUMPSTARTER**
(71) Applicant: **Brown & Watson International Pty Ltd, Knoxfield (AU)**
(72) Inventor: **Mark Finocchiaro, Northcote (AU)**
(73) Assignee: **BROWN & WATSON INTERNATIONAL PTY LTD, Knoxfield (AU)**
(**) Term: **15 Years**
(21) Appl. No.: **29/752,549**
(22) Filed: **Sep. 28, 2020**

D466,475 S 12/2002 Super et al.
D480,357 S 10/2003 Miao
D484,852 S 1/2004 James et al.
D504,396 S 4/2005 Hussaini et al.
D504,870 S 5/2005 Krieger et al.
D511,491 S 11/2005 Hriscu et al.
D514,509 S 2/2006 Krieger et al.
D523,395 S 6/2006 Krieger et al.
D593,941 S 6/2009 Ellsworth
D595,222 S 6/2009 Ellsworth
D601,495 S 10/2009 Shum et al.
D609,633 S 2/2010 Daniels et al.
D609,634 S 2/2010 Daniels et al.
D616,377 S 5/2010 Bussen et al.
D620,881 S 8/2010 Daniels et al.
D636,331 S 4/2011 Inskeep

(Continued)

(30) **Foreign Application Priority Data**

Mar. 26, 2020 (AU) 202011890

(51) **LOC (13) Cl.** **13-02**

(52) **U.S. Cl.**
USPC **D13/107**

(58) **Field of Classification Search**
USPC D13/102-110, 118, 119, 184, 199;
D14/251, 253, 432, 434
CPC H01M 10/44; H01M 10/46; H01M 10/465;
H01M 10/482; H01M 10/4257; H01M
10/0436; H01M 10/48; H01M 2200/30;
H01M 2250/30; H01M 2250/40; Y02T
10/7005; Y02T 10/705; Y02T 10/7088;
Y02E 60/10; Y02E 60/12; Y02E 60/122;
Y02E 60/124; Y02E 60/50; H02J 7/00;
H02J 7/0003; H02J 7/0011; H02J 7/0013;
H02J 7/0054; H02J 7/0055; H02J 7/0057;
H02J 7/0034; H02J 7/1423; H02J
2001/006

See application file for complete search history.

(56) **References Cited**

U.S. PATENT DOCUMENTS

D257,882 S 1/1981 Rawson et al.
D432,985 S 10/2000 Wan

OTHER PUBLICATIONS

U.S. Appl. No. 29/688,756, filed Apr. 24, 2019; Non-Final Office Action dated May 14, 2020; 11 pages.

(Continued)

Primary Examiner — Christy Nemeth

(74) *Attorney, Agent, or Firm* — Cantor Colburn LLP

(57) **CLAIM**

The ornamental design for a jumpstarter, as shown and described.

DESCRIPTION

FIG. 1 is a perspective view of a jumpstarter showing my new design;
FIG. 2 is a top view thereof;
FIG. 3 is a front view thereof;
FIG. 4 is a rear view thereof;
FIG. 5 is a side view thereof; and,
FIG. 6 is another side view thereof.

1 Claim, 6 Drawing Sheets

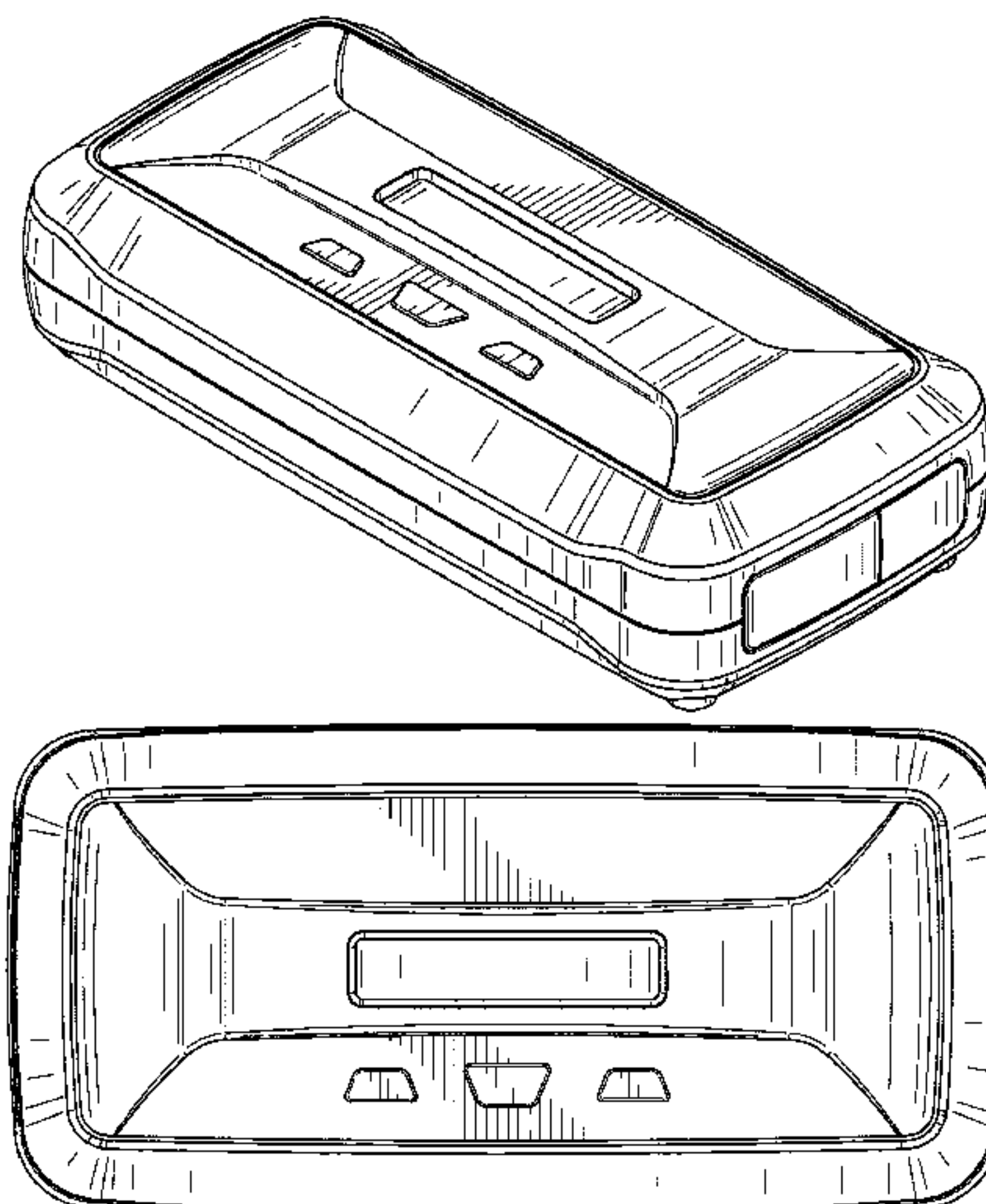

(56)

References Cited

U.S. PATENT DOCUMENTS

D654,865 S 2/2012 Dumelle et al.
 D660,793 S 5/2012 Inskeep
 D674,747 S 1/2013 Nierescher et al.
 D697,472 S 1/2014 Lai
 D710,301 S 8/2014 Ferro
 D711,318 S 8/2014 Xinfang
 D713,786 S * 9/2014 Wen D13/108
 D722,954 S 2/2015 James
 D743,332 S * 11/2015 Ju D13/108
 D753,059 S * 4/2016 Krantz D13/110
 D776,050 S * 1/2017 Awad D13/102
 D780,686 S 3/2017 Glasow
 D780,689 S 3/2017 Inskeep
 D789,292 S 6/2017 Kotsubo et al.
 D803,151 S * 11/2017 Zhou D13/107
 D811,324 S 2/2018 Inskeep
 D813,162 S * 3/2018 Krantz D13/110
 D821,306 S * 6/2018 Liu D13/107
 D821,310 S * 6/2018 Krantz D13/110
 D823,243 S 7/2018 Toscani et al.
 D832,781 S * 11/2018 Nook D13/107
 D864,253 S 10/2019 Thorne et al.
 D871,334 S 12/2019 Chen
 D873,215 S * 1/2020 Wu D13/108
 D875,677 S * 2/2020 Shi D13/108
 D881,807 S * 4/2020 Xu D13/108
 D883,923 S * 5/2020 Keferstein D13/108
 D883,924 S * 5/2020 Chen D13/108
 D885,330 S * 5/2020 Gan D13/107

D896,749 S * 9/2020 Wu D13/107
 D899,354 S * 10/2020 Liu D13/102
 D902,847 S * 11/2020 Sexton D13/107
 D902,851 S * 11/2020 Wu D13/107
 D909,968 S * 2/2021 Chen D13/108
 D917,391 S * 4/2021 Su D13/103
 D918,830 S * 5/2021 Chen D13/108
 D919,572 S * 5/2021 Lei D13/110
 D922,318 S * 6/2021 Miller D13/108
 D926,123 S * 7/2021 Zhu D13/107
 D926,124 S * 7/2021 Zhu D13/107
 D930,578 S * 9/2021 Zheng D13/107
 D931,806 S * 9/2021 Chen D13/108
 D934,793 S * 11/2021 Shu D13/107
 D934,796 S * 11/2021 Liao D13/108
 D937,763 S * 12/2021 Wang D13/107
 D940,648 S * 1/2022 Taylor D13/103
 D942,931 S * 2/2022 Fang D13/110
 D943,516 S * 2/2022 Wang D13/107
 D944,191 S * 2/2022 Wang D13/107
 2011/0187322 A1 8/2011 Inskeep
 2021/0391624 A1 * 12/2021 Yang H01M 6/5044

OTHER PUBLICATIONS

U.S. Appl. No. 29/688,765, filed Apr. 24, 2019; Non-Final Office
 Action dated May 15, 2020; 13 pages.
 U.S. Appl. No. 29/688,779, filed Apr. 24, 2019; Non-Final Office
 Action dated May 15, 2020; 10 pages.

* cited by examiner

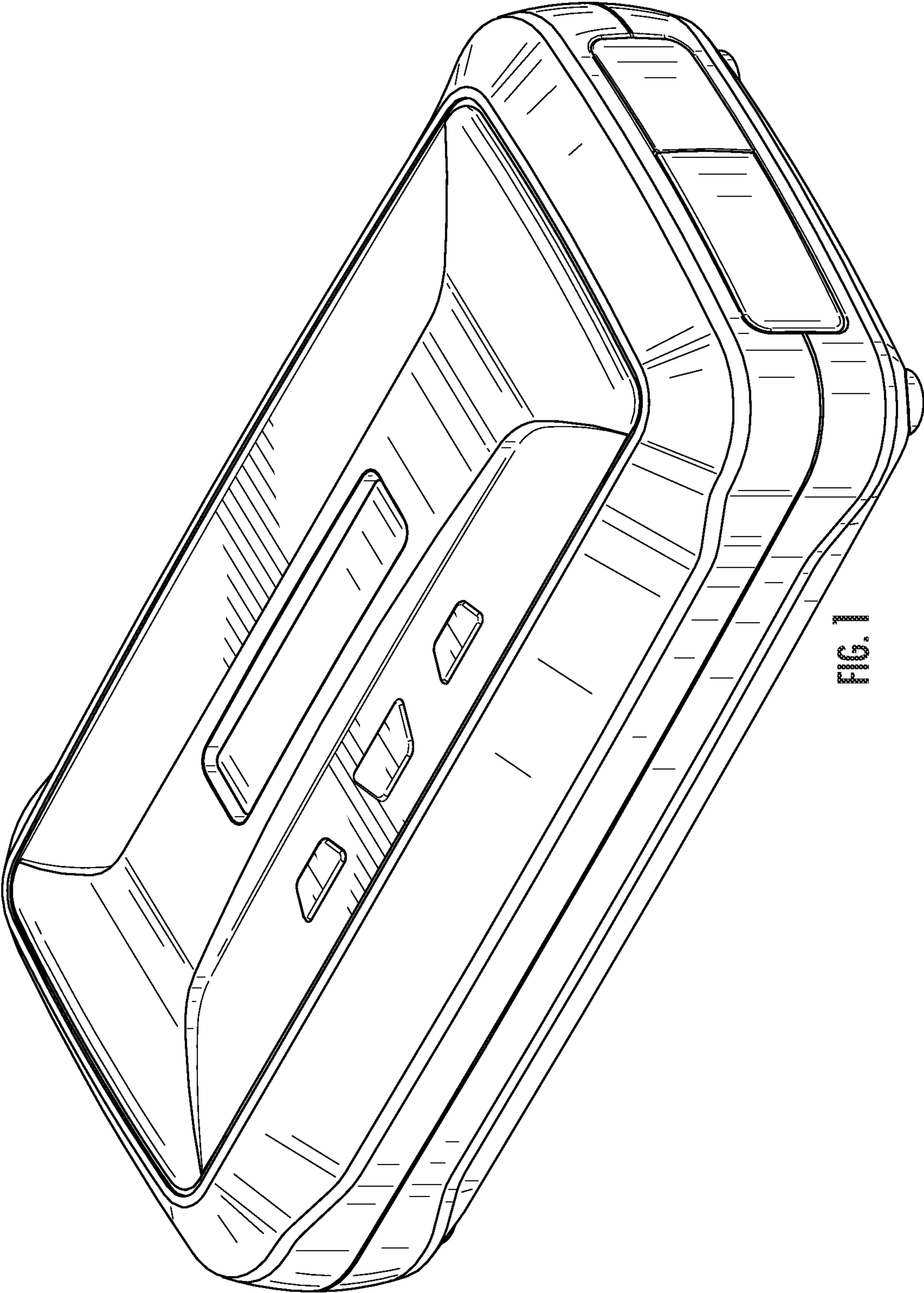

FIG. 1

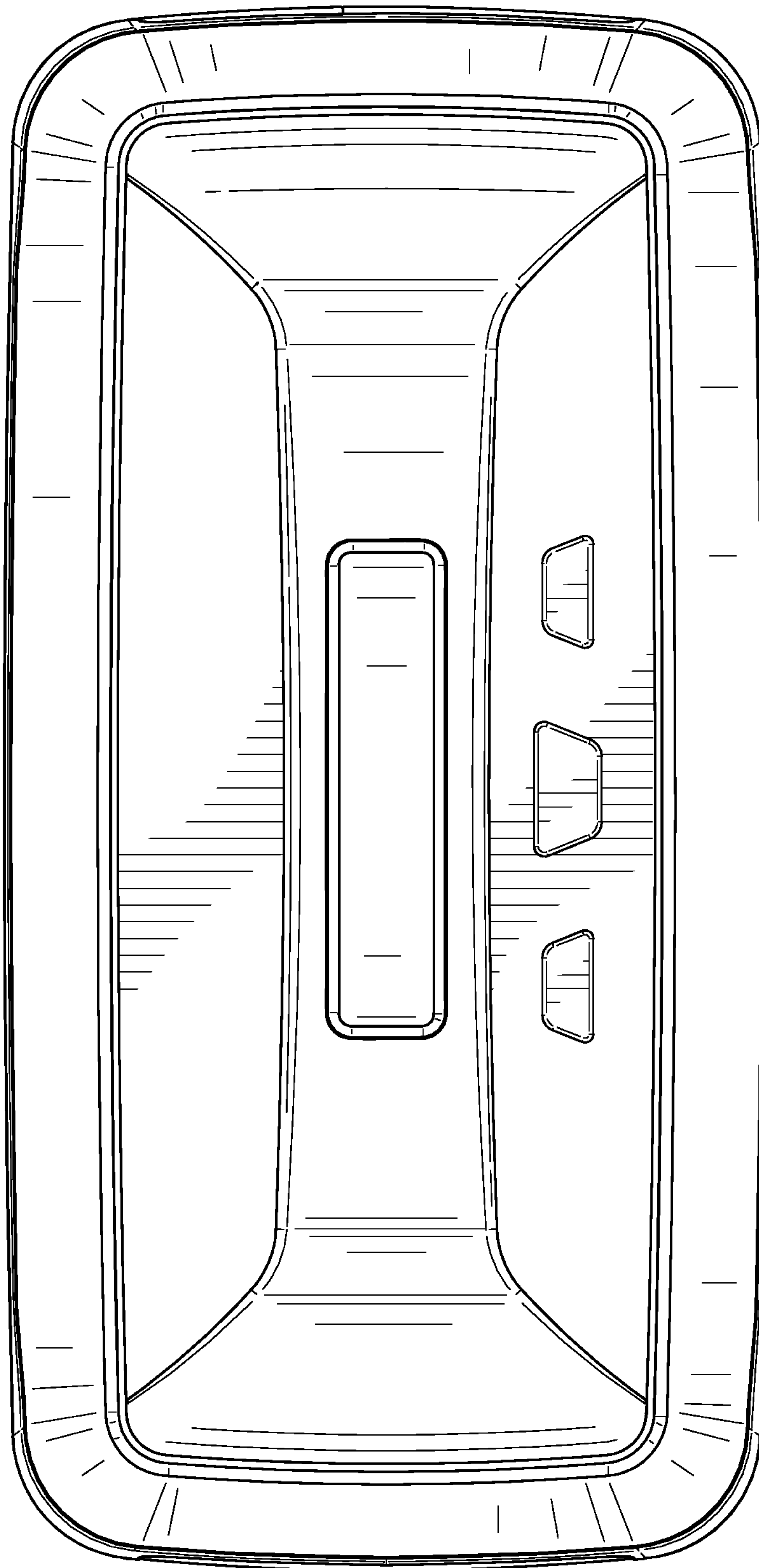

FIG. 2

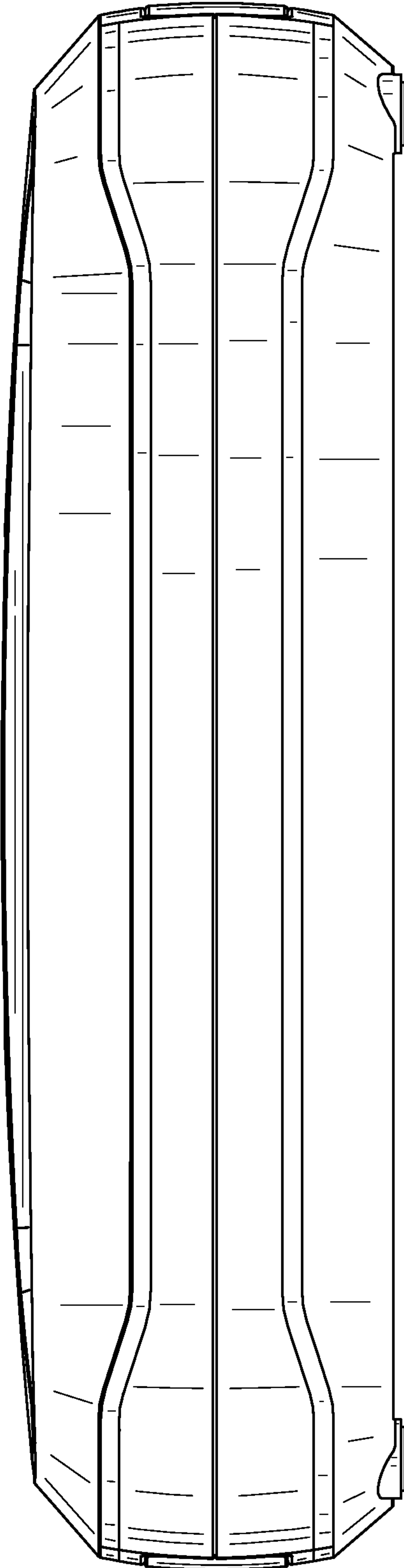

FIG. 3

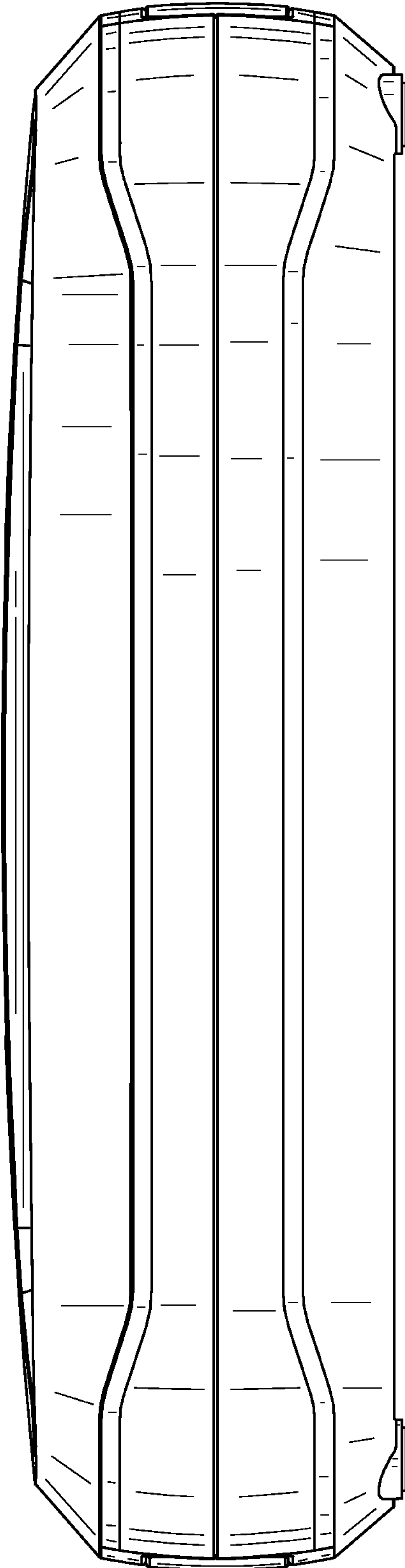

FIG. 4

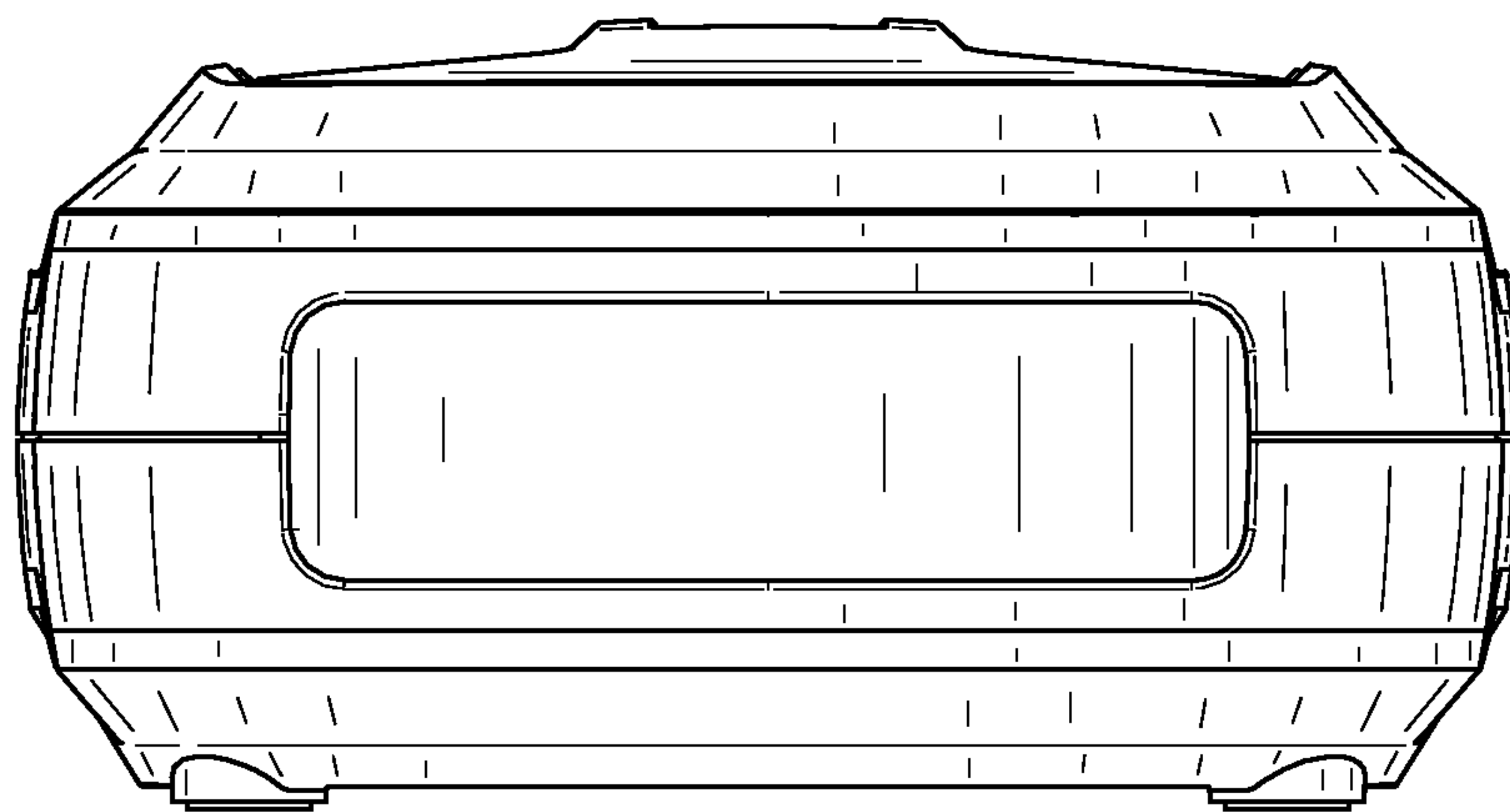

FIG. 5

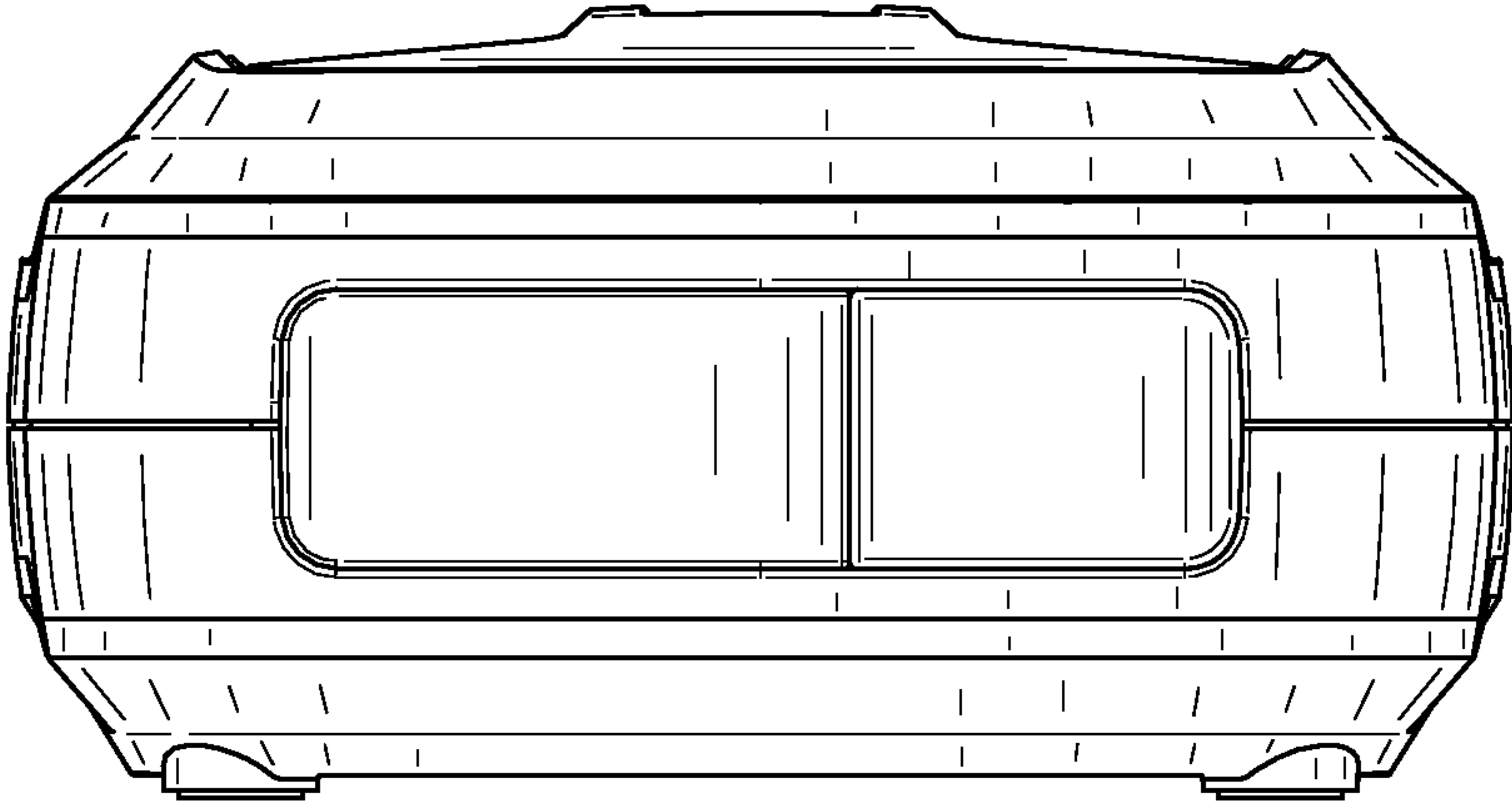

FIG. 6