



US00D958042S

(12) **United States Design Patent**  
**Berche et al.**

(10) **Patent No.:** **US D958,042 S**  
(45) **Date of Patent:** **\*\* Jul. 19, 2022**

- (54) **PERSONAL WATERCRAFT FRONT FASCIA**
- (71) Applicant: **BOMBARDIER RECREATIONAL PRODUCTS INC., Valcourt (CA)**
- (72) Inventors: **Charles-Edouard Berche, Bromont (CA); Francois Chenevert, Sherbrooke (CA); Christopher Rudwal, Montreal (CA)**
- (73) Assignee: **BOMBARDIER RECREATIONAL PRODUCTS INC., Valcourt (CA)**

- D487,718 S 3/2004 Bills et al.
- 6,843,192 B1 1/2005 Nugteren et al.
- D501,820 S 2/2005 Bucaccio et al.
- D507,230 S 7/2005 Bucaccio et al.
- D510,900 S 10/2005 Bucaccio et al.
- D511,320 S 11/2005 Bucaccio et al.
- D513,225 S 12/2005 Omae et al.
- D516,006 S 2/2006 Bucaccio et al.
- D516,993 S 3/2006 Bucaccio et al.
- D518,767 S 4/2006 Bucaccio et al.
- D519,437 S 4/2006 Bucaccio et al.
- D519,438 S 4/2006 Bucaccio et al.
- D519,909 S 5/2006 Bucaccio et al.

(Continued)

(\*\*) Term: **15 Years**

*Primary Examiner* — Cynthia M. Chin

(21) Appl. No.: **29/727,119**

(74) *Attorney, Agent, or Firm* — BCF LLP

(22) Filed: **Mar. 9, 2020**

(51) **LOC (13) Cl.** ..... **12-06**

(52) **U.S. Cl.**

USPC ..... **D12/307; D12/317**

(58) **Field of Classification Search**

USPC ..... D12/6–10, 300, 307, 317

CPC ..... B63B 34/00; B63B 34/10; B63H 11/00

See application file for complete search history.

(56) **References Cited**

**U.S. PATENT DOCUMENTS**

- D307,414 S 4/1990 Lapointe
- D325,556 S 4/1992 Lapointe
- D326,839 S 6/1992 Lapointe
- D399,182 S 10/1998 Lapointe et al.
- 6,112,685 A 9/2000 Matsuda et al.
- D462,931 S 9/2002 Aselton et al.
- D464,015 S 10/2002 Bucaccio et al.
- D464,016 S 10/2002 Orr et al.
- D464,926 S 10/2002 Mizuta et al.
- D465,192 S \* 11/2002 Bucaccio ..... D12/307
- D476,612 S 7/2003 Bills et al.
- D479,702 S 9/2003 Cassell et al.
- D485,527 S 1/2004 Cassell et al.

(57) **CLAIM**

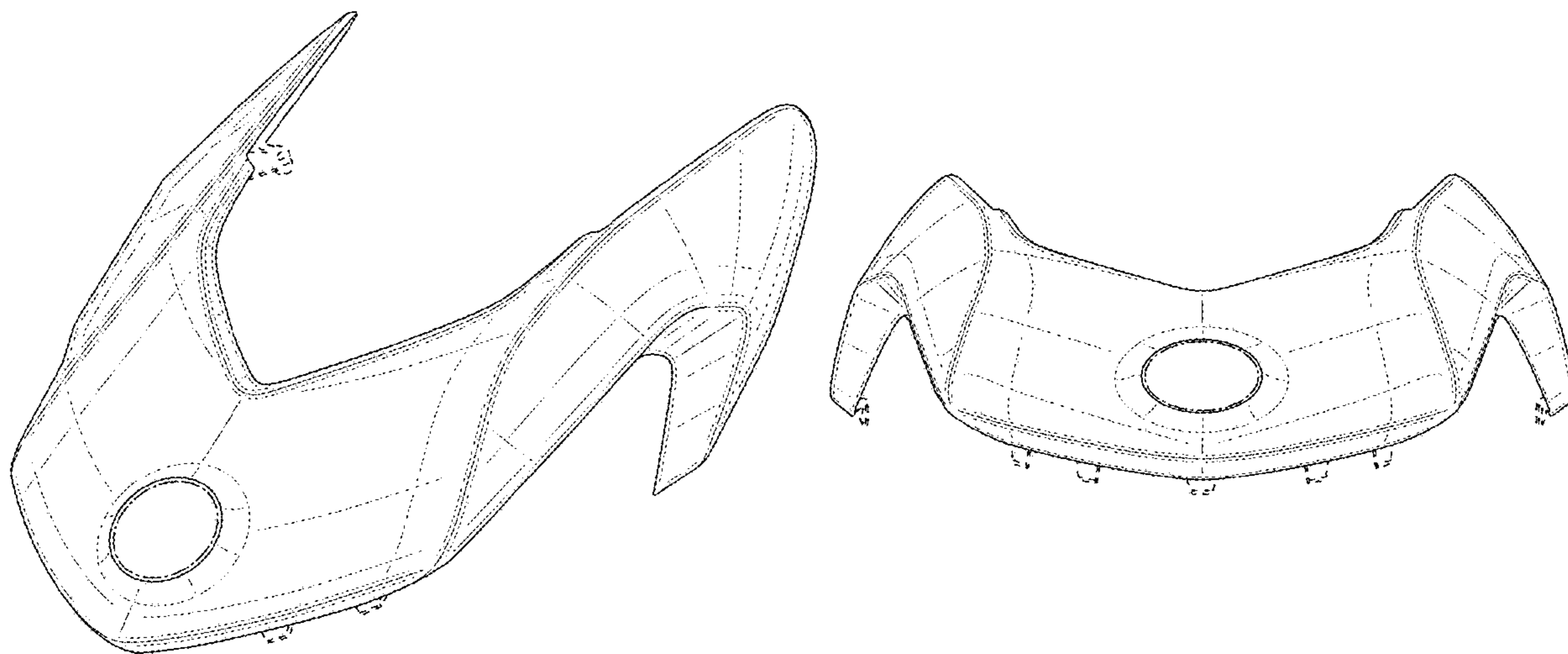
The ornamental design for a personal watercraft front fascia, as shown and described.

**DESCRIPTION**

FIG. 1 is a perspective view taken from a front, left, top side of a personal watercraft front fascia according to our design; FIG. 2 is a front elevation view thereof; FIG. 3 is a rear elevation view thereof; FIG. 4 is a right side elevation view thereof; FIG. 5 is a left side elevation view thereof; FIG. 6 is a top plan view thereof; and, FIG. 7 is a bottom plan view thereof.

Throughout the Figures, where shown: (i) the dashed lines and unshaded surfaces bound thereby are included to identify parts of the article's appearance that form no part of the claimed design; and (ii) the dotted/dashed lines are included for the purpose of illustrating unclaimed boundaries of surfaces claimed as part of the design. The claimed design is intended to cover any physical, digital and virtual representation of the design illustrated in the Figures.

**1 Claim, 7 Drawing Sheets**



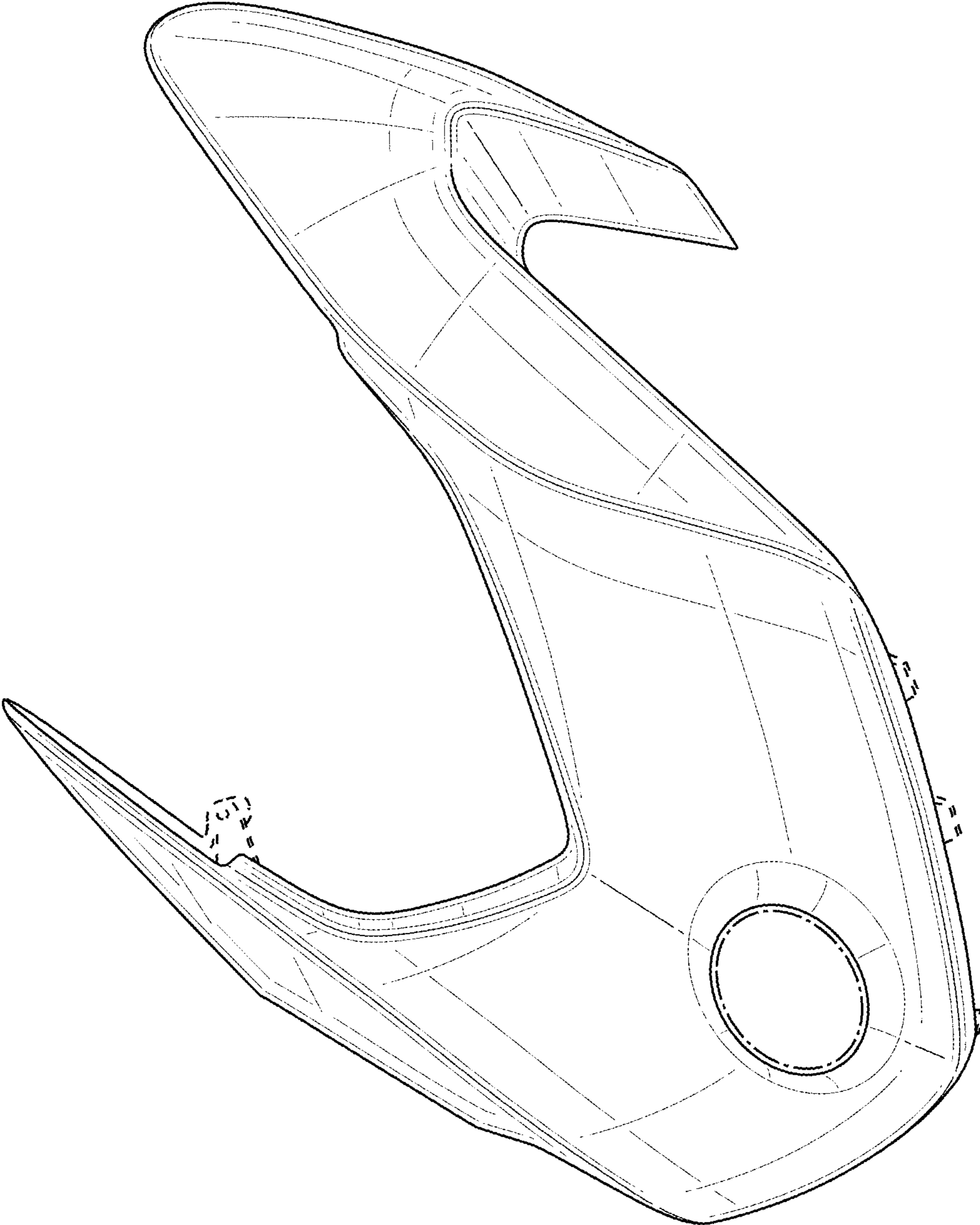
(56)

**References Cited**

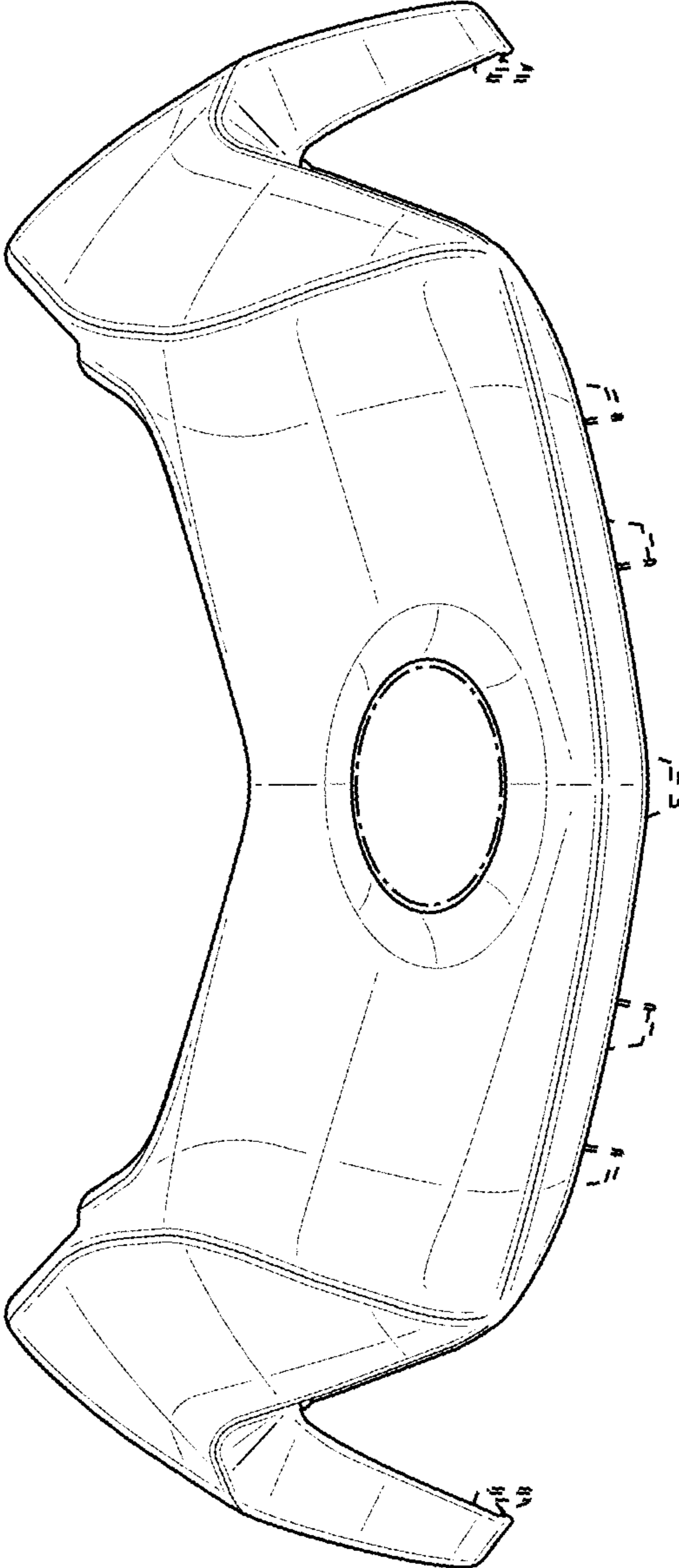
U.S. PATENT DOCUMENTS

D527,701 S	9/2006	Bucaccio et al.	D670,603 S	11/2012	Lepine et al.	
D550,603 S	9/2007	Cote et al.	D686,967 S *	7/2013	Yamamoto .....	D12/307
D550,605 S	9/2007	Cote et al.	D691,939 S	10/2013	Cote et al.	
D569,781 S	5/2008	Hattori et al.	D692,366 S	10/2013	Cote et al.	
D574,314 S	8/2008	Kato et al.	D693,286 S	11/2013	Cote et al.	
D575,720 S	8/2008	Kato et al.	D721,634 S	1/2015	Cote et al.	
D579,380 S	10/2008	Petit	D734,239 S	7/2015	Cote et al.	
D580,822 S	11/2008	Longpre et al.	D750,006 S *	2/2016	Yamamoto .....	D12/307
D592,100 S *	5/2009	Petit .....	D796,401 S	9/2017	Akita et al.	
		D12/7	D802,473 S	11/2017	Lepine et al.	
D603,319 S	11/2009	Cote et al.	D817,849 S *	5/2018	Yamamoto .....	D12/307
D608,719 S	1/2010	Cote et al.	D862,358 S	10/2019	Berche et al.	
D630,995 S	1/2011	Cote et al.	D869,372 S *	12/2019	Yamamoto .....	D12/307
D632,632 S	2/2011	Cote	D883,898 S	5/2020	Berche et al.	
D636,322 S	4/2011	Cote	D892,709 S	8/2020	Berche et al.	
D636,323 S	4/2011	Cote	2003/0131774 A1	7/2003	Funayose et al.	
D636,324 S	4/2011	Cote	2004/0168622 A1	9/2004	Thompson et al.	
D637,544 S	5/2011	Cote et al.	2009/0107377 A1 *	4/2009	Duquette .....	B63B 34/10 114/55.57
D644,590 S	9/2011	Cote et al.	2012/0180710 A1 *	7/2012	Otsuka .....	B63B 49/00 114/55.5
D647,839 S	11/2011	Seymour	2018/0029672 A1 *	2/2018	Sato .....	B63B 34/10

\* cited by examiner

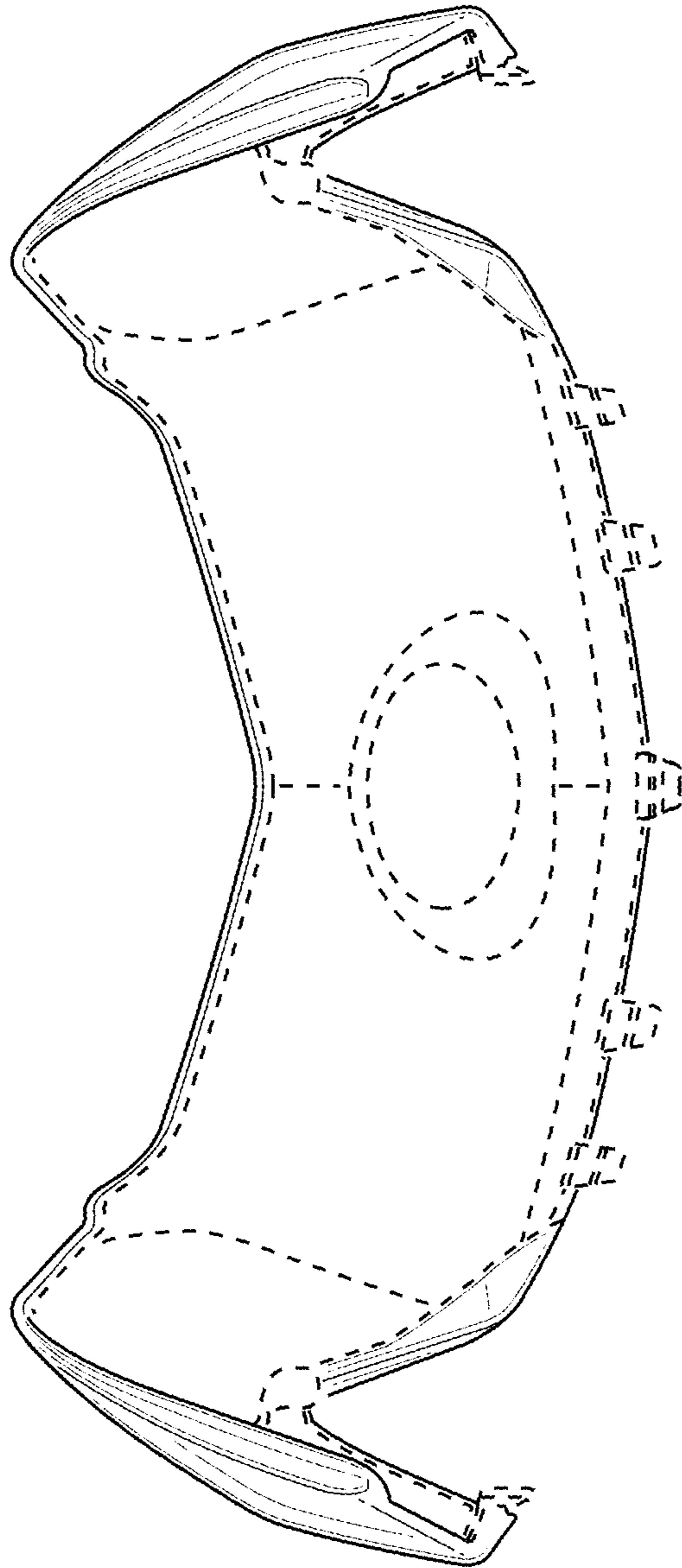


**FIG. 1**

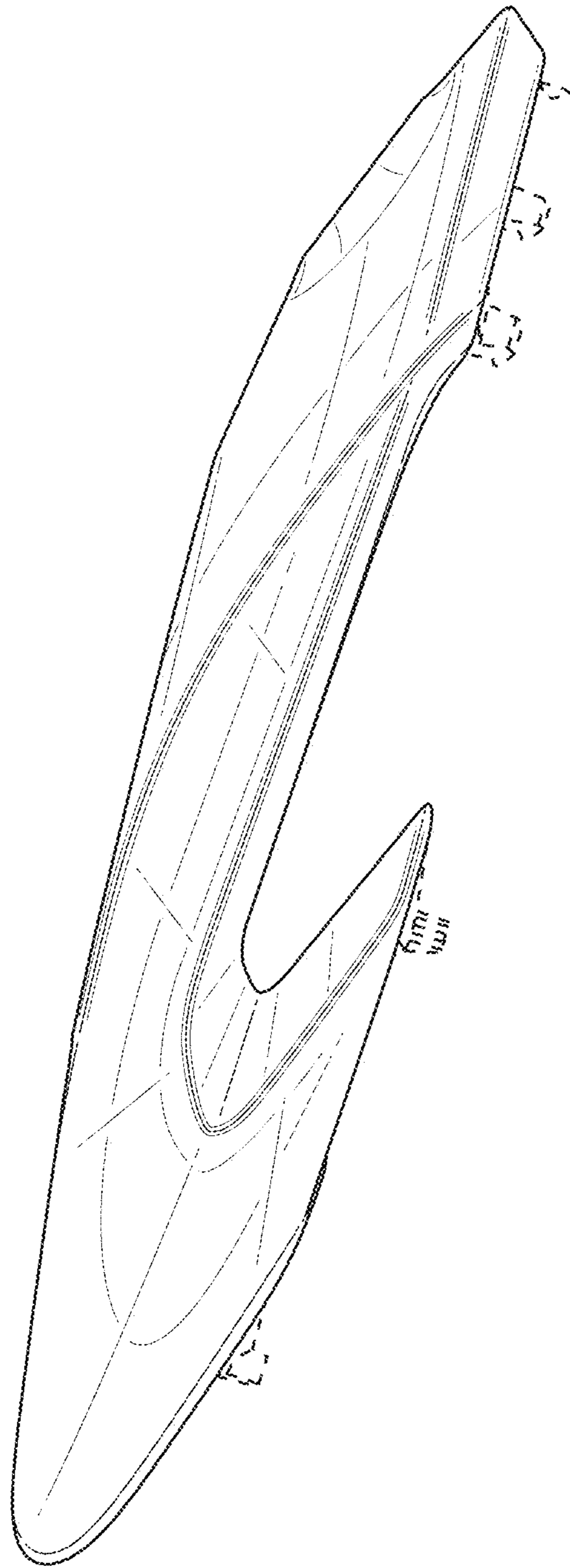


**FIG. 2**

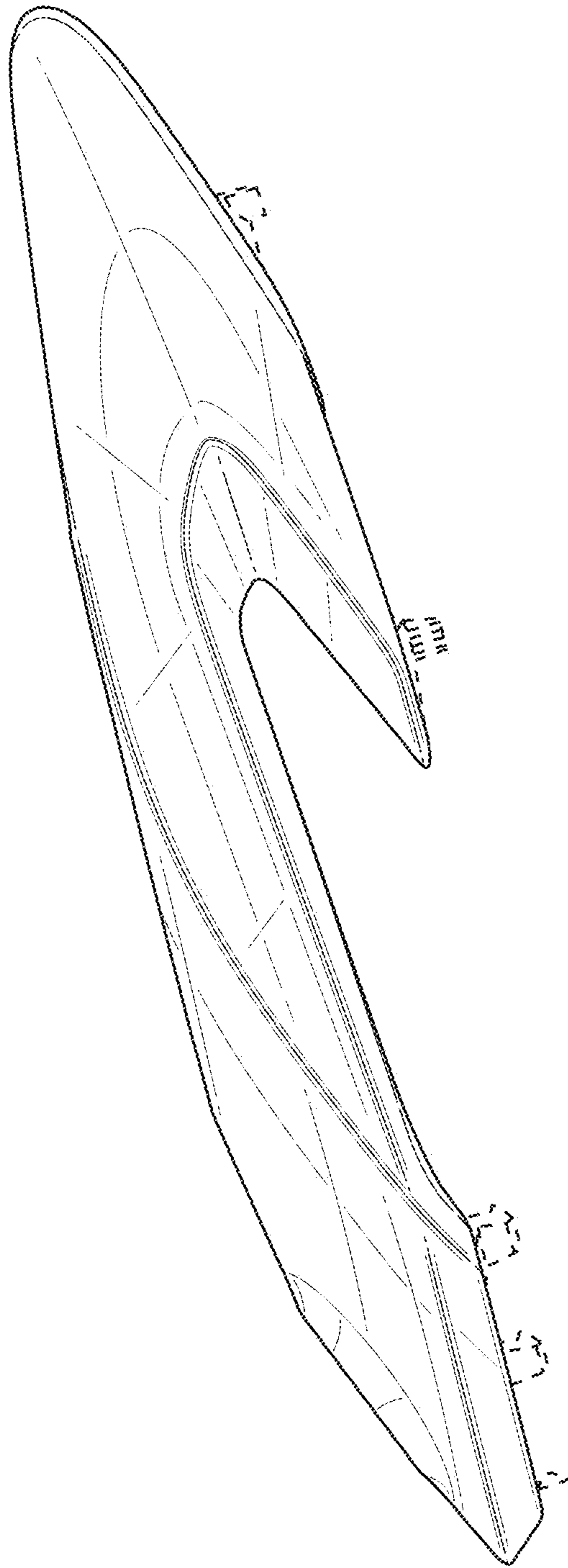




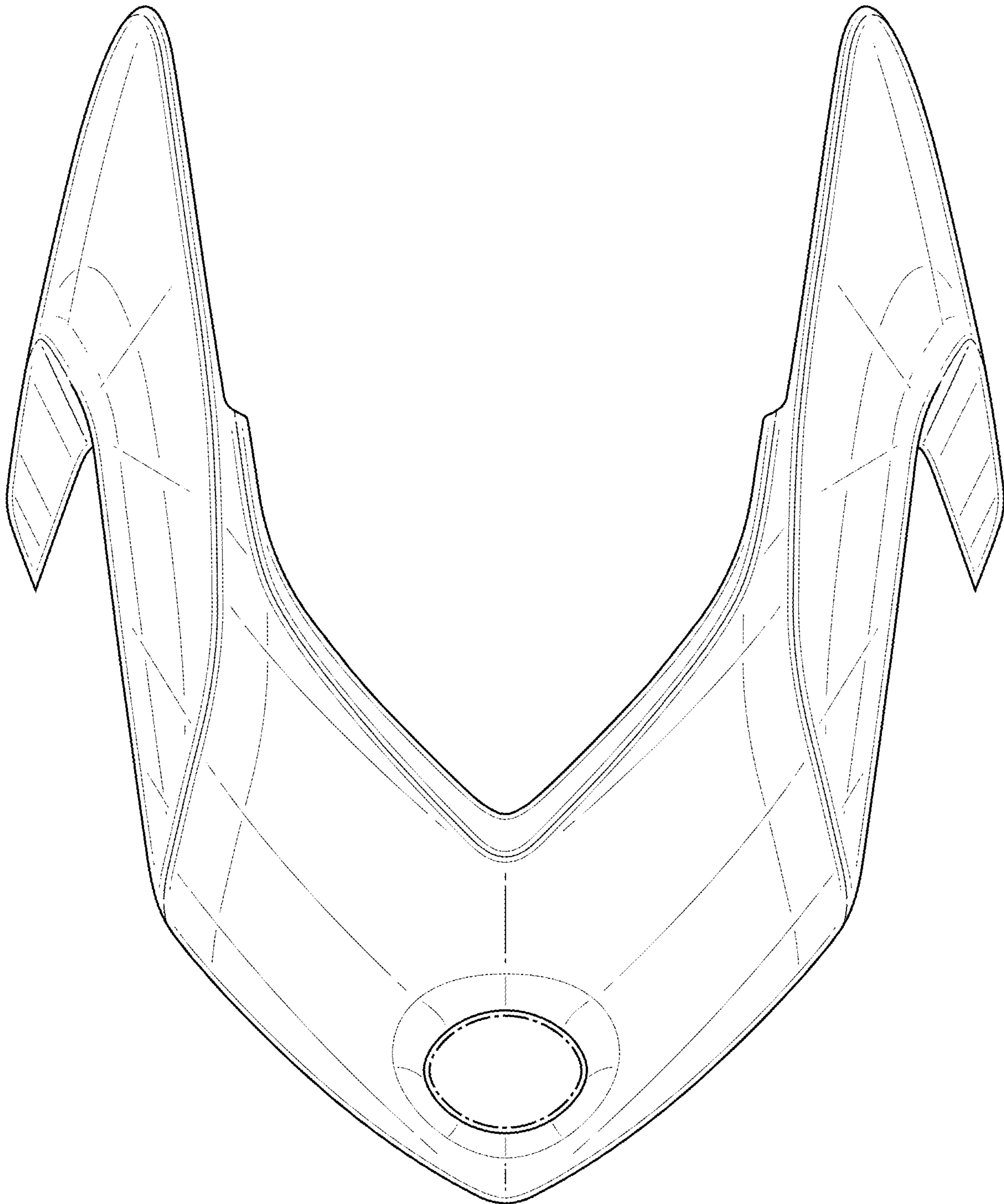
**FIG. 3**



**FIG. 4**

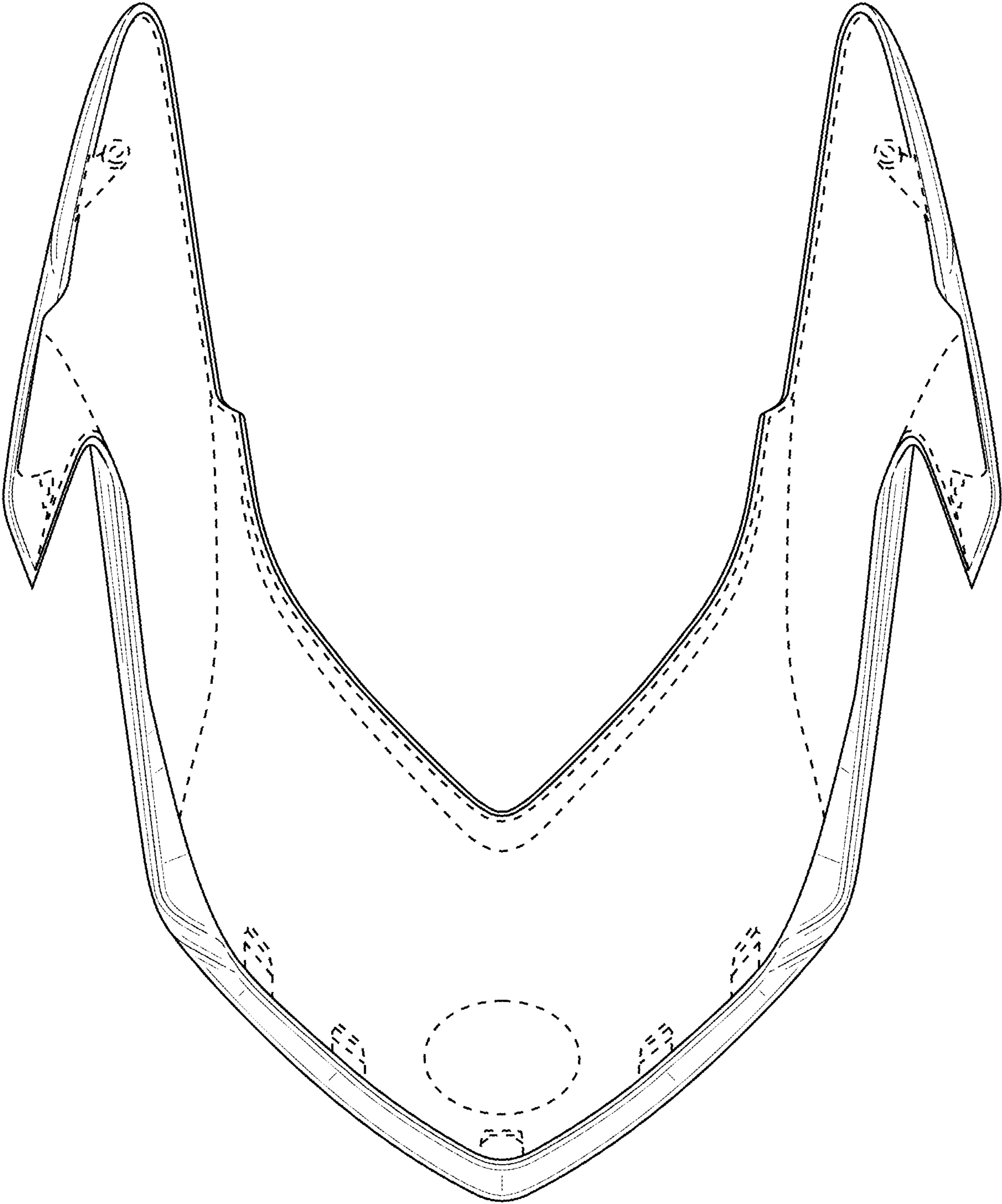


**FIG. 5**



**FIG. 6**





**FIG. 7**