



US00D957932S

(12) **United States Design Patent** (10) **Patent No.:** **US D957,932 S**
David et al. (45) **Date of Patent:** **** Jul. 19, 2022**

(54) **PACKAGING**

(71) Applicant: **Apple Inc.**, Cupertino, CA (US)

(72) Inventors: **Ryan David**, Escondido, CA (US);
Benjamin Arthur Stevenson, Oakland, CA (US)

(73) Assignee: **Apple Inc.**, Cupertino, CA (US)

(**) Term: **15 Years**

(21) Appl. No.: **29/684,484**

(22) Filed: **Mar. 21, 2019**

Related U.S. Application Data

(63) Continuation of application No. 29/663,174, filed on Sep. 12, 2018, now Pat. No. Des. 918,036.

(51) **LOC (13) Cl.** **09-03**

(52) **U.S. Cl.**
USPC **D9/414**

(58) **Field of Classification Search**
USPC D9/414, 423, 711, 432, 721, 418, 415;
D8/356; D6/300; D3/319; D14/223
CPC H01R 13/60; B65H 75/14
See application file for complete search history.

(56) **References Cited**

U.S. PATENT DOCUMENTS

D577,295 S * 9/2008 Miller D9/711
D620,781 S * 8/2010 Weckworth D8/356
D639,186 S * 6/2011 Shapiro D9/721

D685,771 S * 7/2013 Bertenthal D14/223
D697,791 S * 1/2014 Jones D9/423
D706,643 S * 6/2014 Akana D9/721
D739,657 S * 9/2015 Hsieh D3/319
D740,653 S * 10/2015 Akana D9/418
D779,834 S * 2/2017 Ryan D6/300
D798,737 S * 10/2017 Miller D9/711
D806,537 S * 1/2018 Cernokus D9/432
D896,629 S * 9/2020 Akana D9/415
2007/0020993 A1 * 1/2007 Symons B65H 75/14
439/501
2013/0134252 A1 * 5/2013 Cheng H01R 13/60
242/405.1

* cited by examiner

Primary Examiner — Rhea Shields

(74) *Attorney, Agent, or Firm* — Sterne, Kessler, Goldstein & Fox P.L.L.C.

(57) **CLAIM**

The ornamental design for a packaging, as shown and described.

DESCRIPTION

FIG. 1 is a top front perspective view of packaging showing the claimed design;
FIG. 2 is a front view thereof;
FIG. 3 is a rear view thereof;
FIG. 4 is a left side view thereof;
FIG. 5 is a right side view thereof;
FIG. 6 is a top view thereof; and,
FIG. 7 is a bottom view thereof.

The broken lines in the figures show portions of the packaging that form no part of the claimed design.

1 Claim, 4 Drawing Sheets

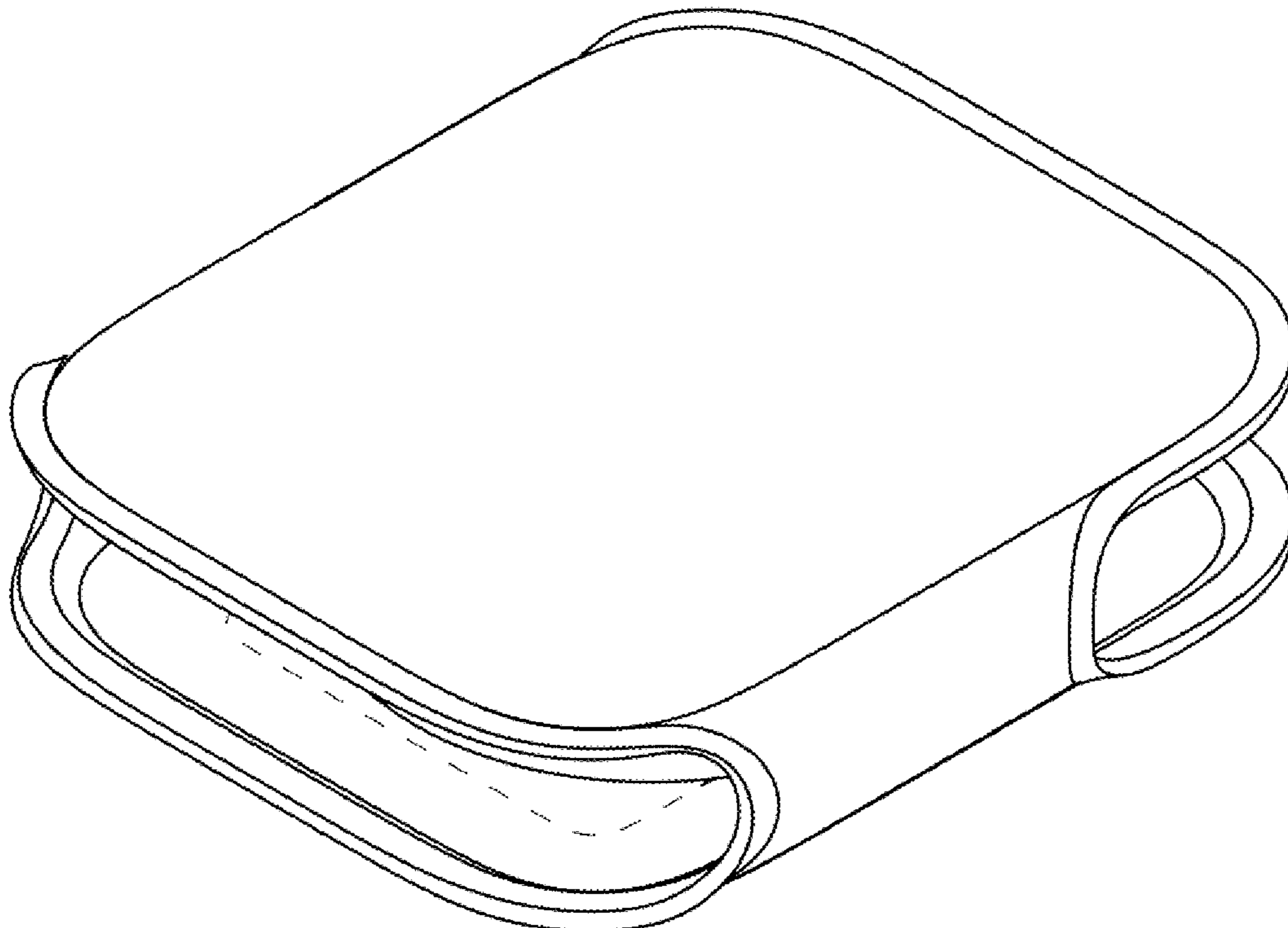

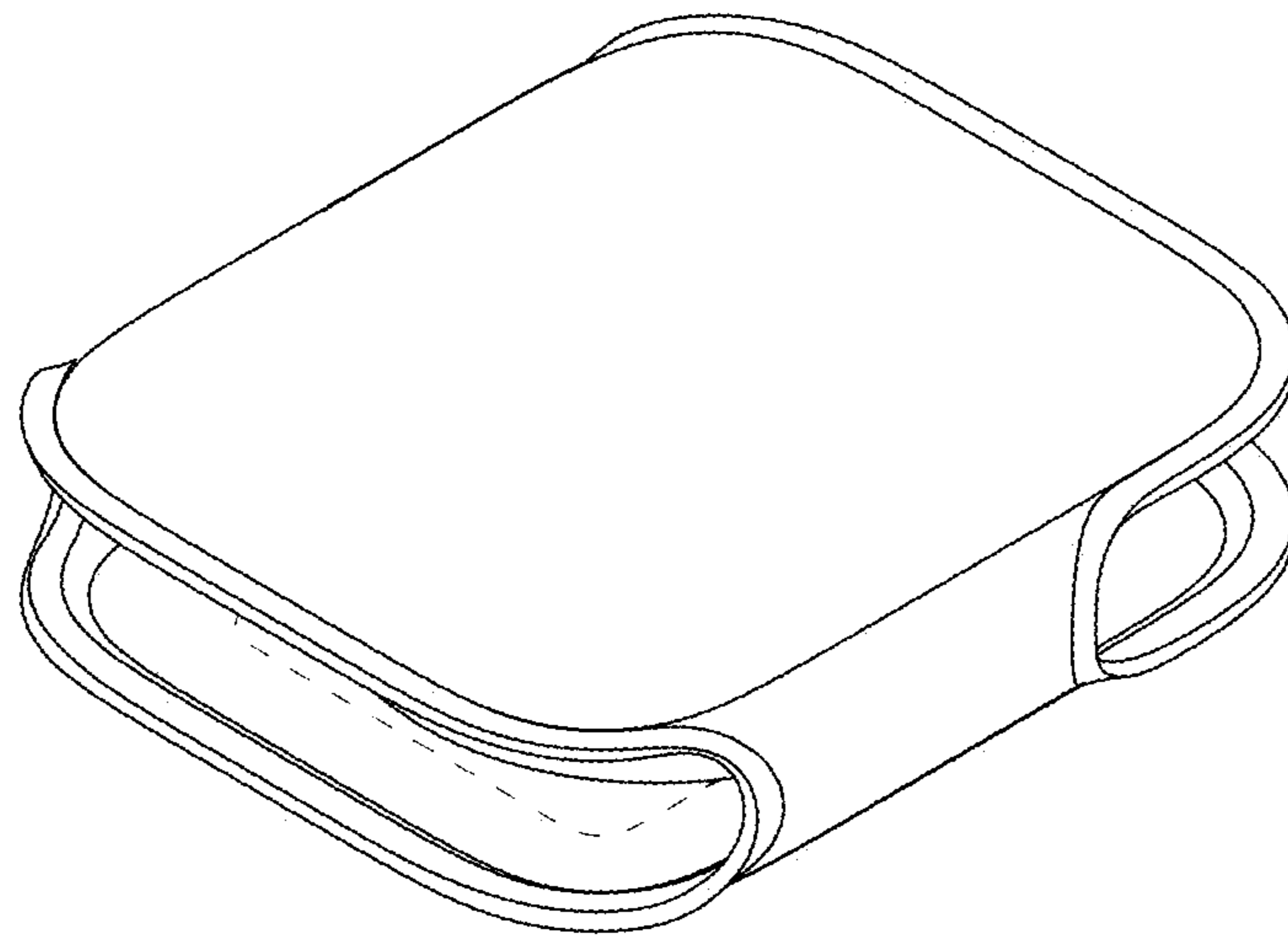

FIG. 1

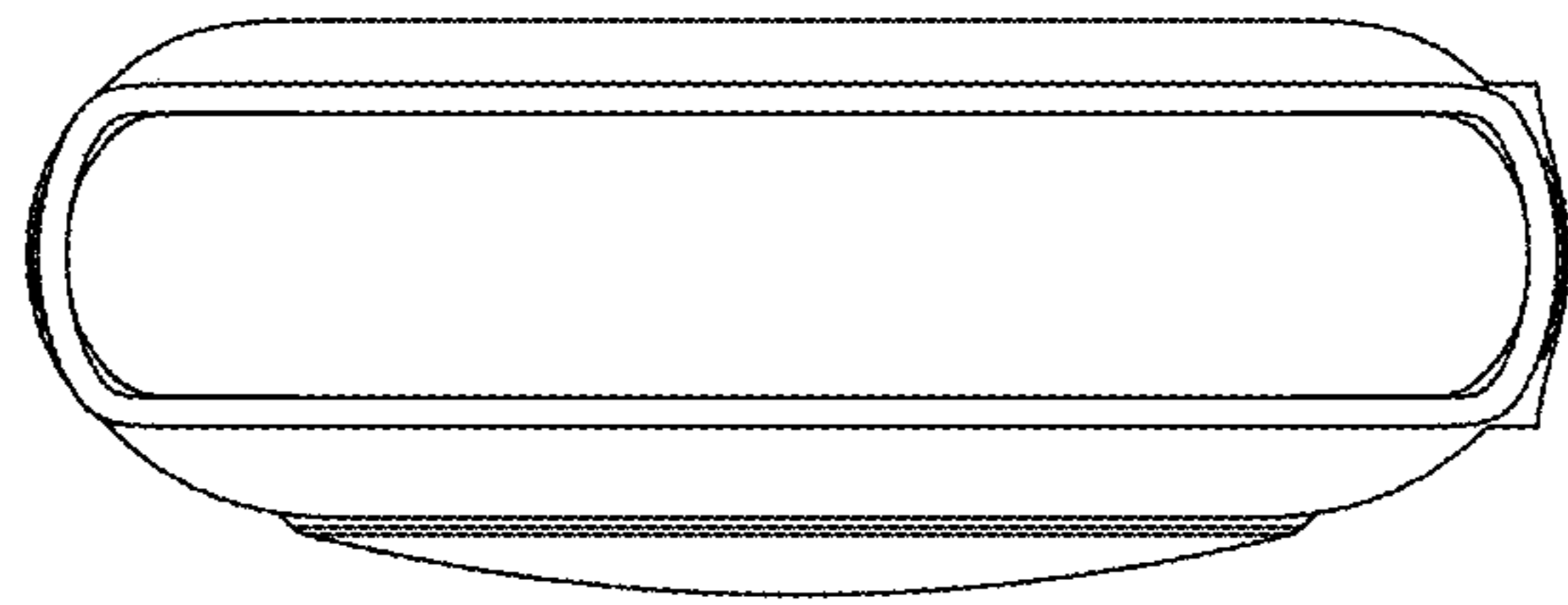

FIG. 2

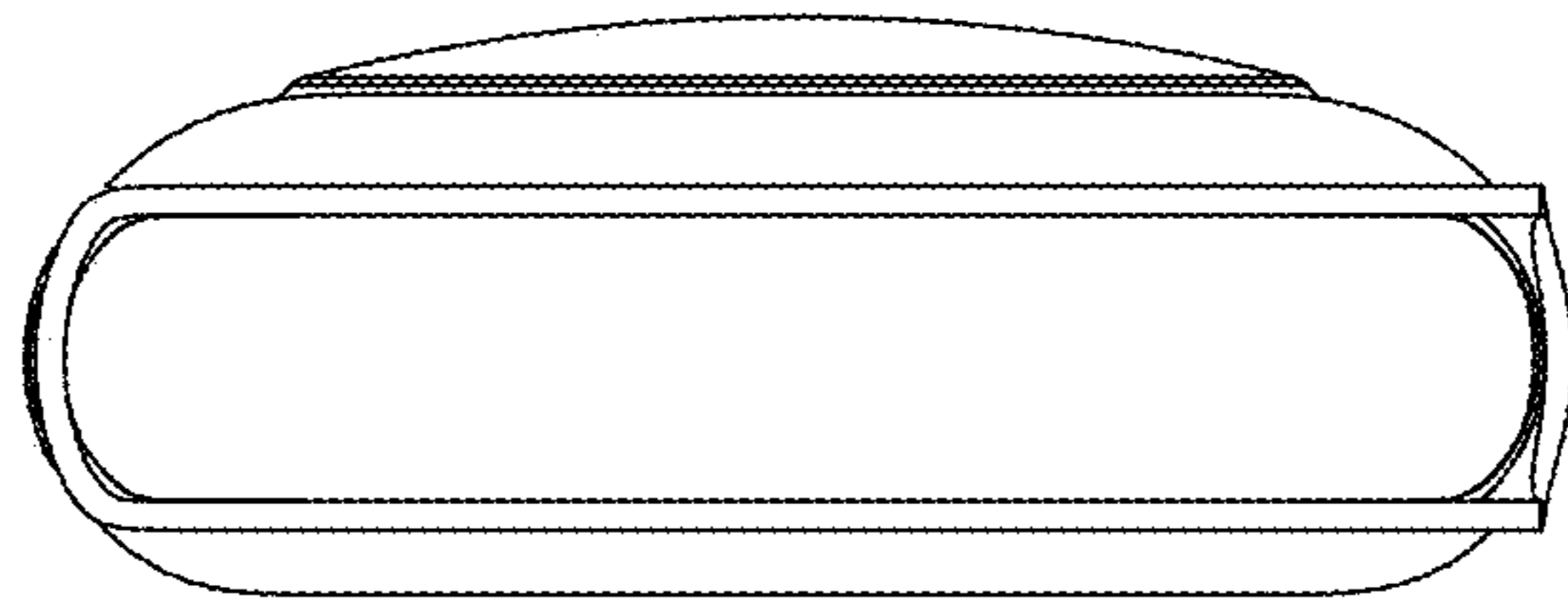

FIG. 3

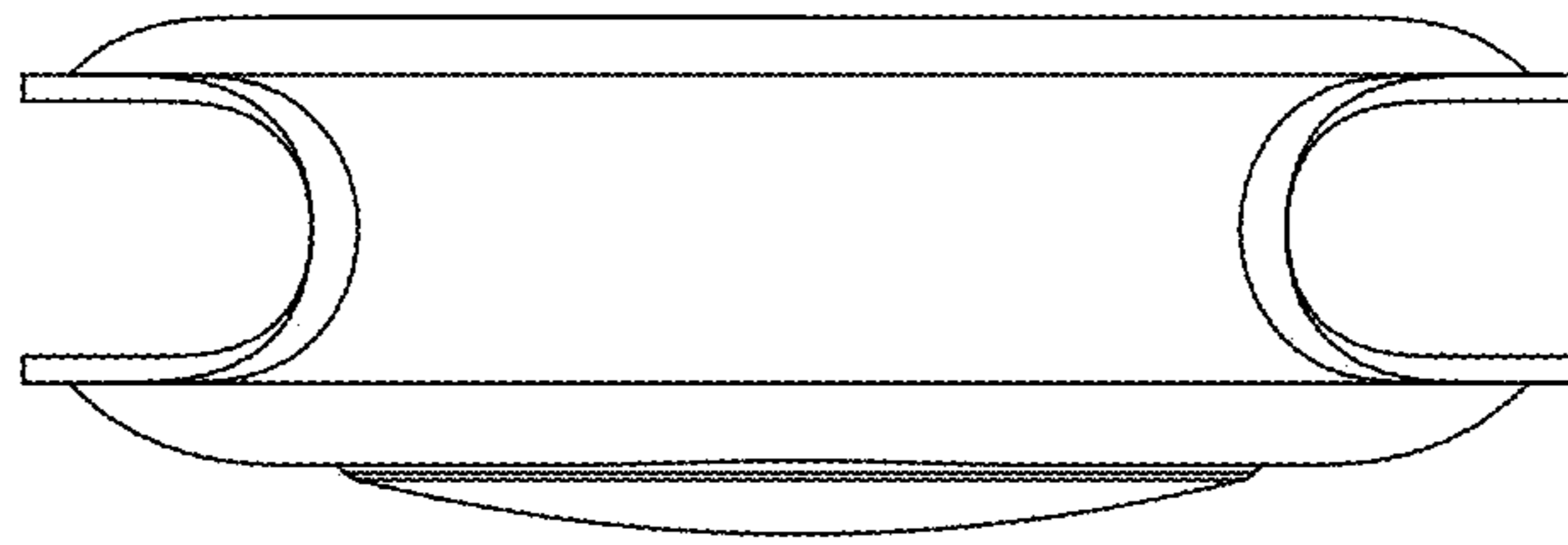

FIG. 4

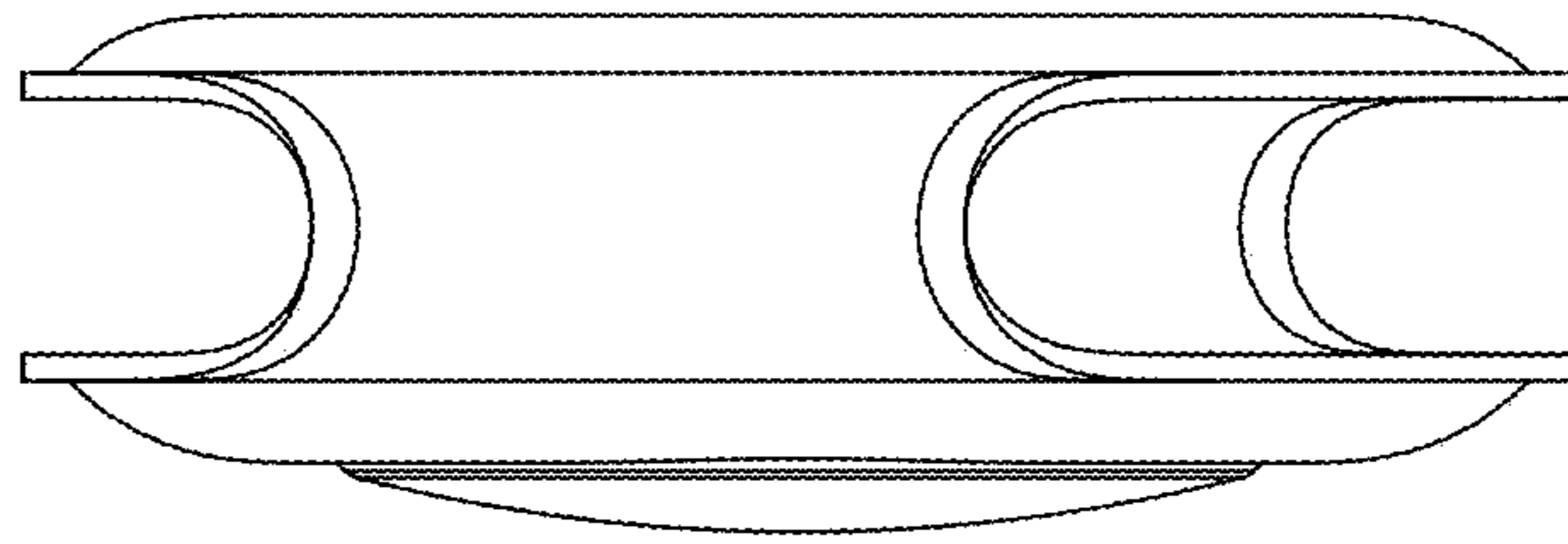

FIG. 5

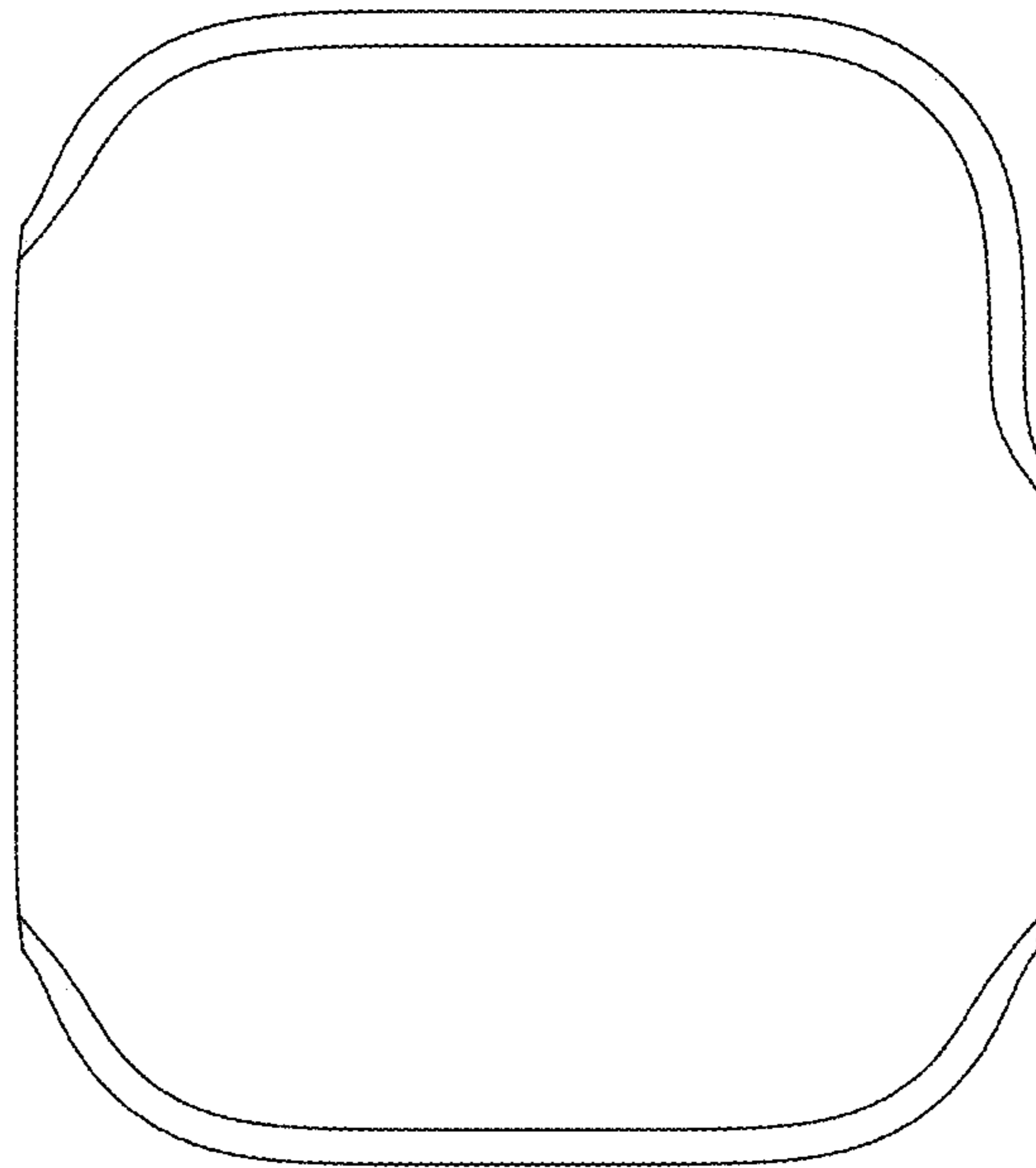

FIG. 6

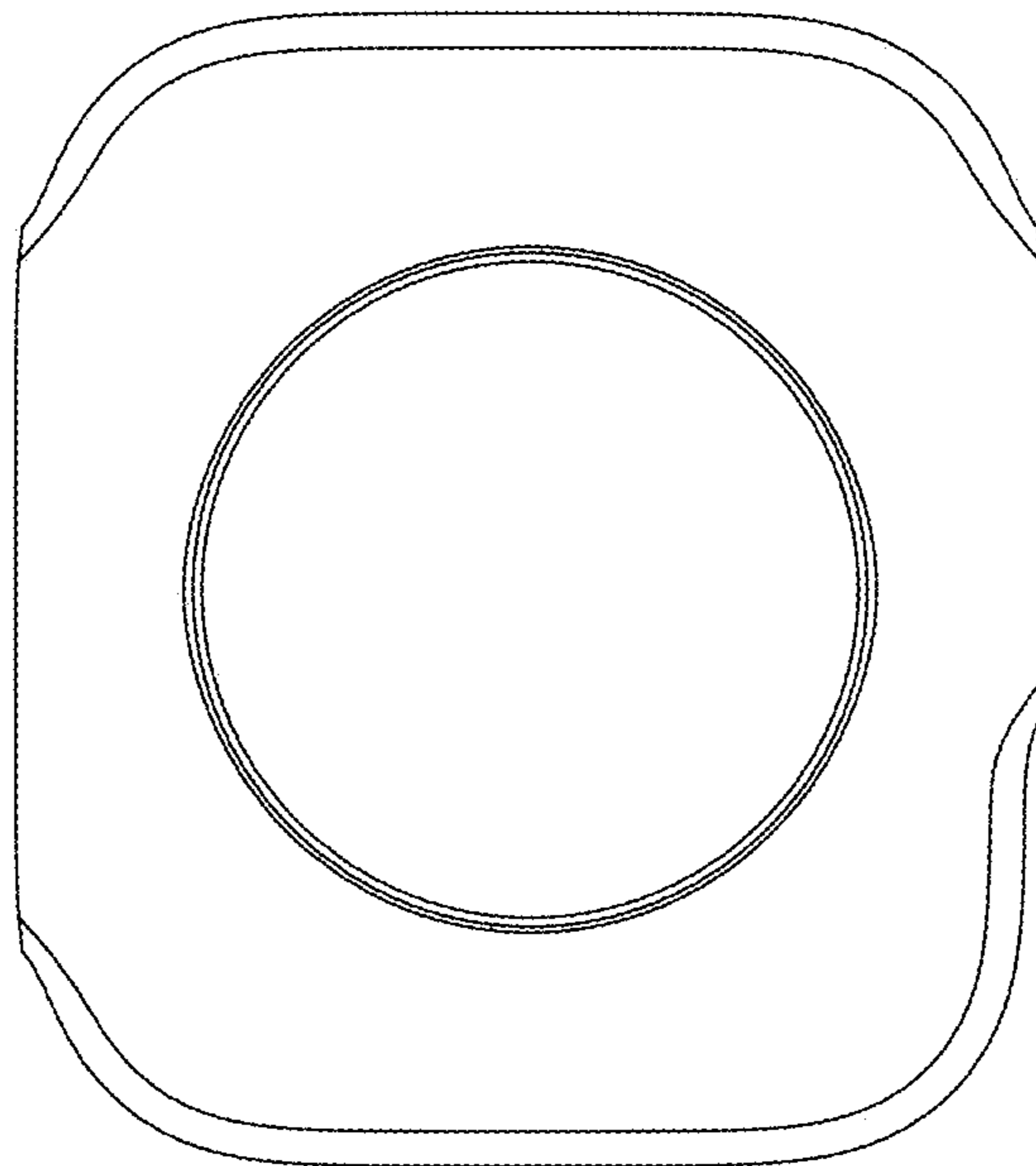

FIG. 7