



US00D957931S

(12) **United States Design Patent**
Farley

(10) **Patent No.:** **US D957,931 S**
(45) **Date of Patent:** **** Jul. 19, 2022**

- (54) **DOOR SECURITY STOPPER**
- (71) Applicant: **Daniel Farley**, Delbarton, WV (US)
- (72) Inventor: **Daniel Farley**, Delbarton, WV (US)
- (**) Term: **15 Years**
- (21) Appl. No.: **29/757,137**
- (22) Filed: **Nov. 3, 2020**
- (51) **LOC (13) Cl.** **08-09**
- (52) **U.S. Cl.**
USPC **D8/402**
- (58) **Field of Classification Search**
USPC D8/336, 349, 353, 354, 355, 367, 373,
D8/402, 380, 382, 383, 394, 396
CPC E05C 17/443
See application file for complete search history.

D696,104 S * 12/2013 Kampl D8/394
D772,052 S * 11/2016 Mutamba D8/402
D904,867 S * 12/2020 Cox D8/402

FOREIGN PATENT DOCUMENTS

EP 2644810 A2 10/2013
EP 3309334 A1 4/2018

OTHER PUBLICATIONS

Hesco, Tolco Super Door Stop, <<https://www.hescoinc.com/tolco-super-door-stop>>.

(Continued)

Primary Examiner — Keli L Hill
Assistant Examiner — Harold E Blackwell, II

(57) **CLAIM**

The ornamental design for a door security stopper, as shown and described.

DESCRIPTION

FIG. 1 is a top-front-left perspective view of a door security stopper showing my new design;
FIG. 2 is a bottom-rear-right perspective view thereof;
FIG. 3 is a front elevated view thereof;
FIG. 4 is a rear elevated view thereof;
FIG. 5 is a top plan view thereof;
FIG. 6 is a bottom plan view thereof;
FIG. 7 is a right elevated view thereof;
FIG. 8 is a left elevated view thereof;
FIG. 9 is a front view thereof, showing the door security stopper wedged under a door in a first configuration; and,
FIG. 10 is a front view thereof, showing the door security stopper wedged under a door in a second configuration.
The broken lines showing of the lower edge of a door in FIG. 9-10 are included for the purpose of showing environmental structure and form no part of the claimed design.

1 Claim, 10 Drawing Sheets

(56) **References Cited**

U.S. PATENT DOCUMENTS

- 786,831 A * 4/1905 McMahon E05C 17/54
292/343
- D197,342 S * 1/1964 Doble D8/9
- 3,758,141 A * 9/1973 Weinberger E05C 17/54
16/DIG. 40
- D249,574 S * 9/1978 Kralevich D8/18
- D302,939 S * 8/1989 Ruskin D8/395
- D303,756 S * 10/1989 Meyers D8/402
- 5,211,722 A * 5/1993 Wagner A01G 20/30
47/1.01 R
- D379,298 S * 5/1997 Bowen D8/395
- D379,299 S * 5/1997 Fitzgibbons D8/395
- D481,932 S * 11/2003 Bess D8/394
- D578,872 S * 10/2008 Healy D8/402
- D601,413 S * 10/2009 Wise D8/402
- D604,156 S * 11/2009 Healy D8/402
- D625,594 S * 10/2010 Park D8/402
- D635,453 S * 4/2011 Giles D8/402
- D682,081 S * 5/2013 Crawford D8/402

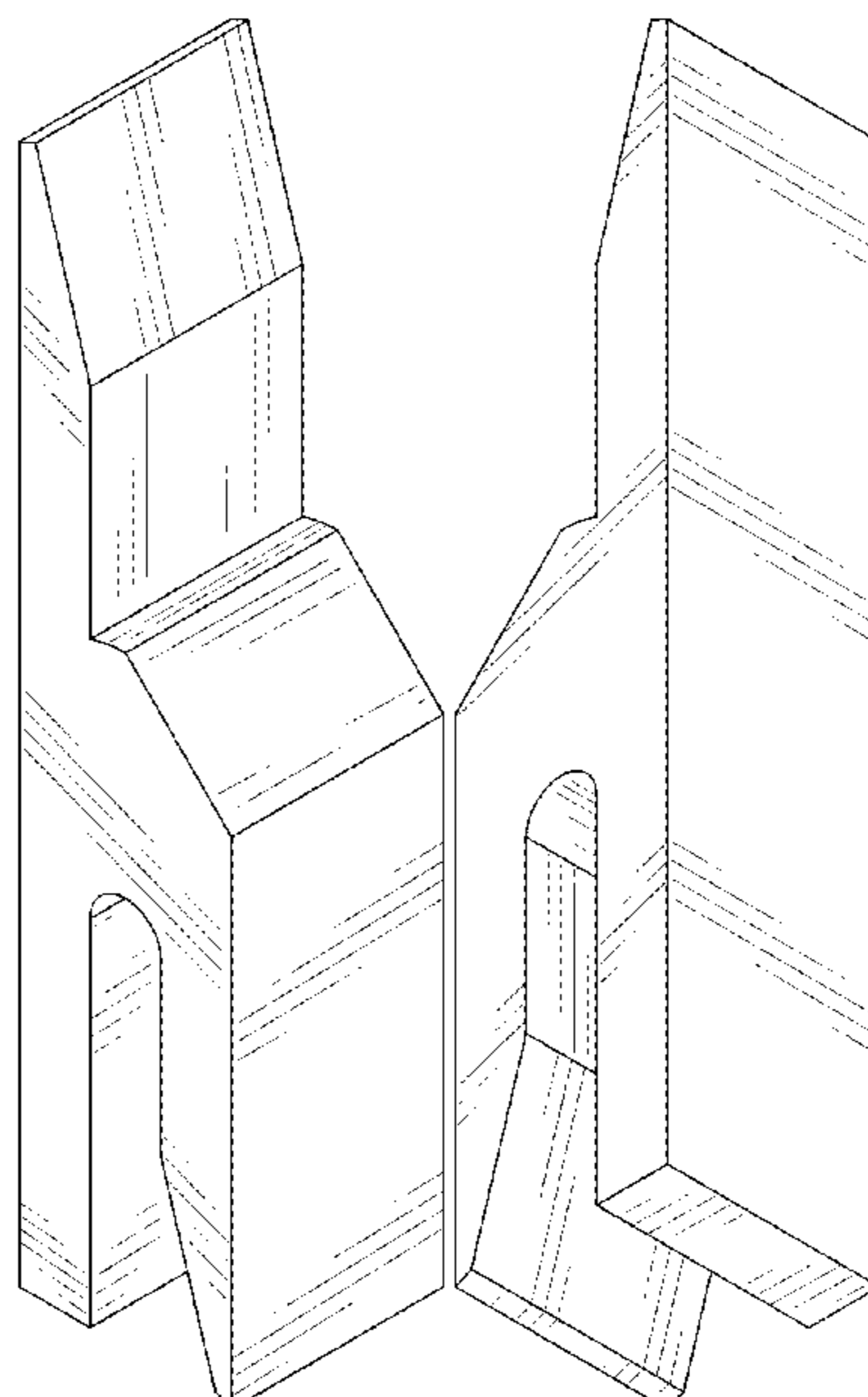

(56)

References Cited

OTHER PUBLICATIONS

Homefixated, The Glamorous World of Rubber Door Stoppers,

<<https://homefixated.com/rubber-door-stopper/>>.

Amazon, Doorprop Residential Door Stopper (Multiple Sizes),

<<https://www.amazon.com/Doorprop-Residential-Stopper-Multiple-Sizes/dp/B07YC8MD8S?th=1>>.

* cited by examiner

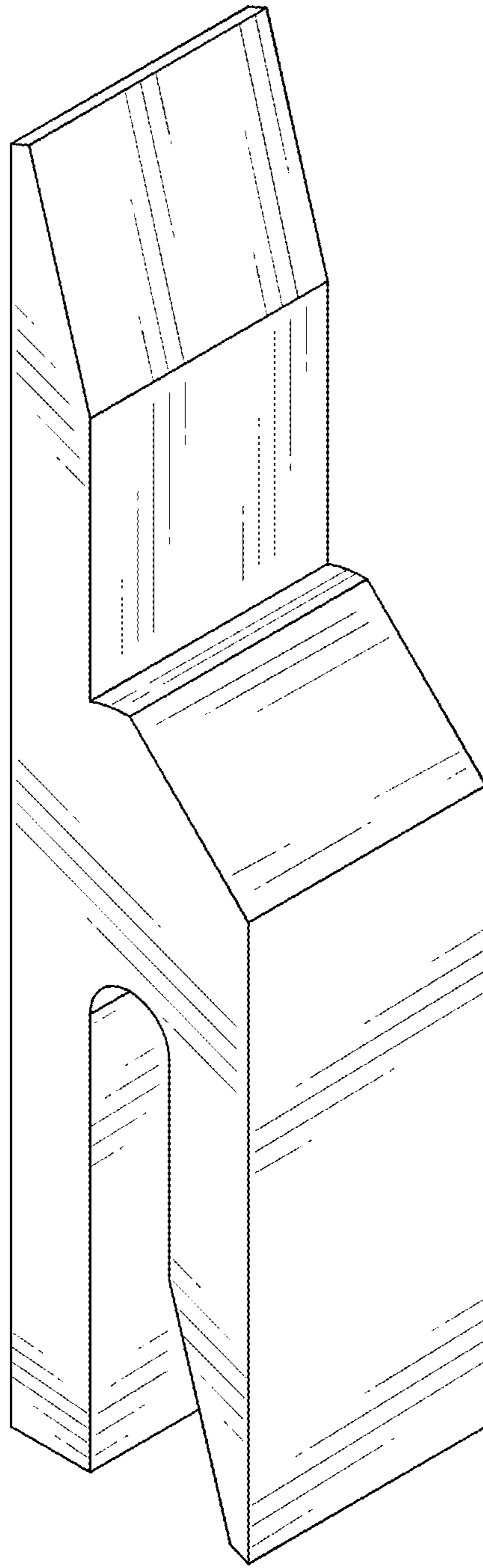

FIG. 1

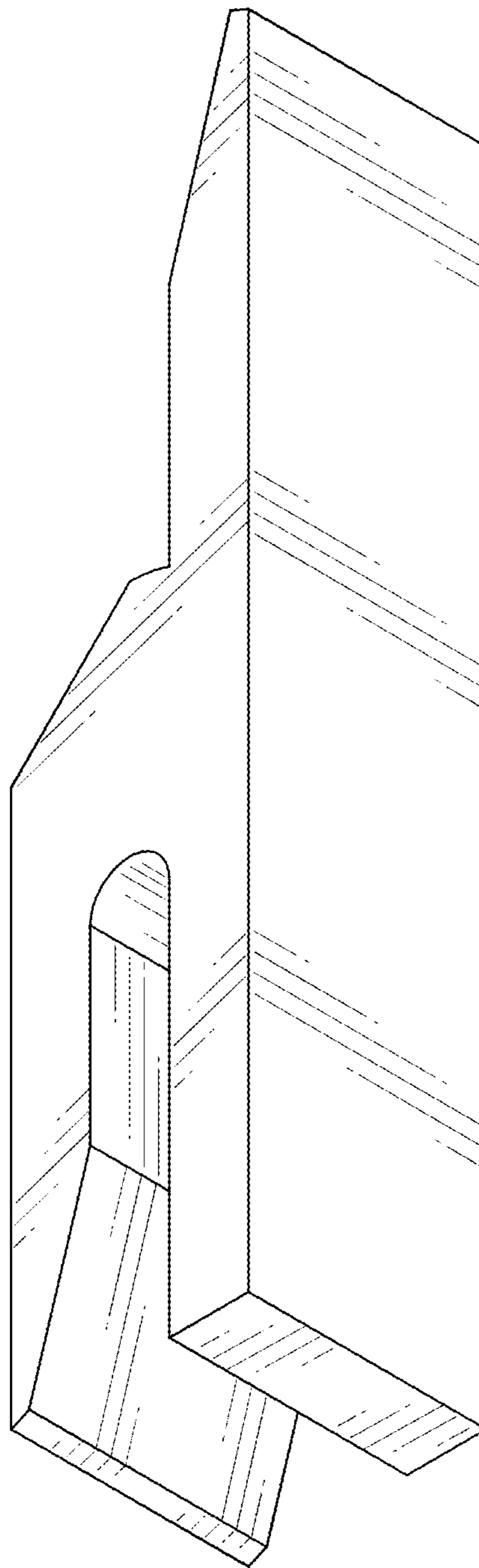

FIG. 2

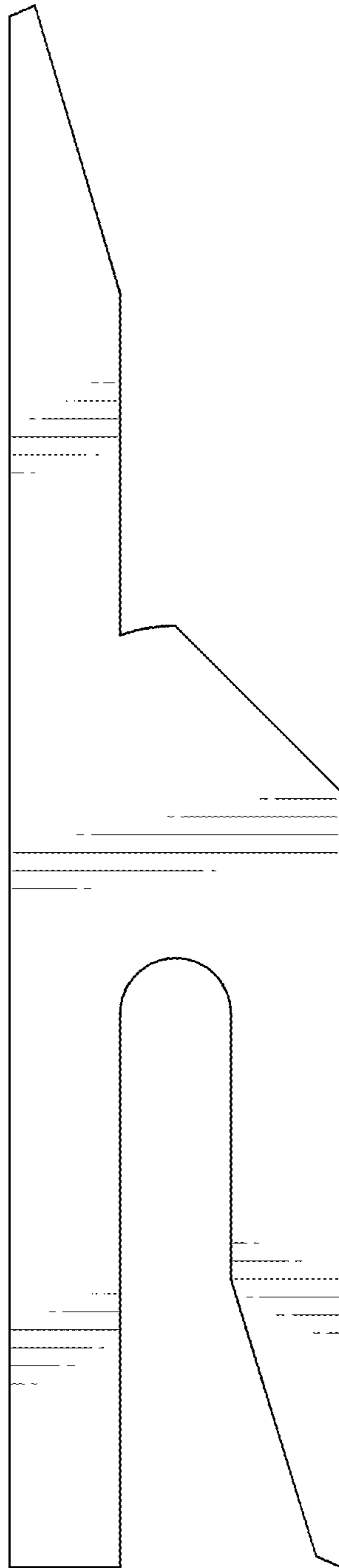

FIG. 3

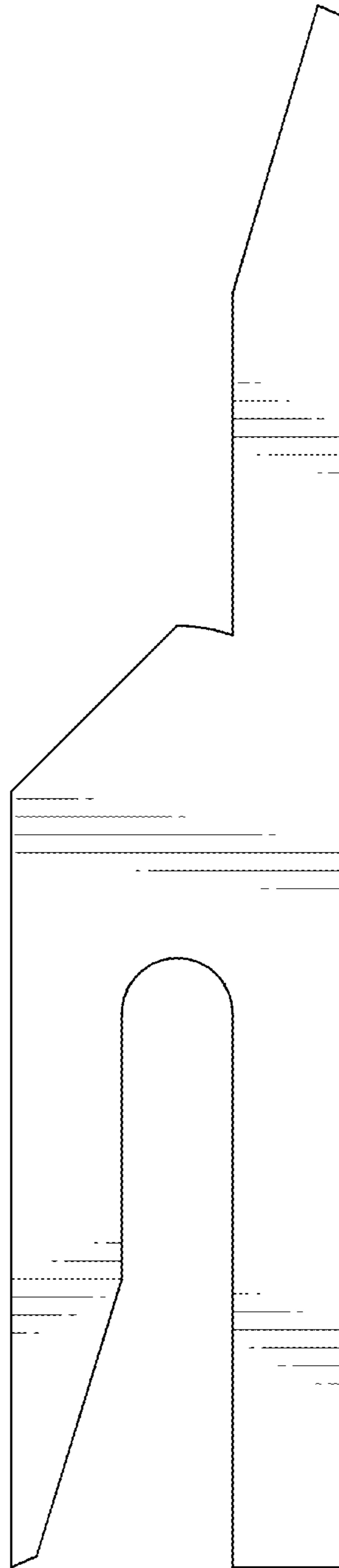

FIG. 4

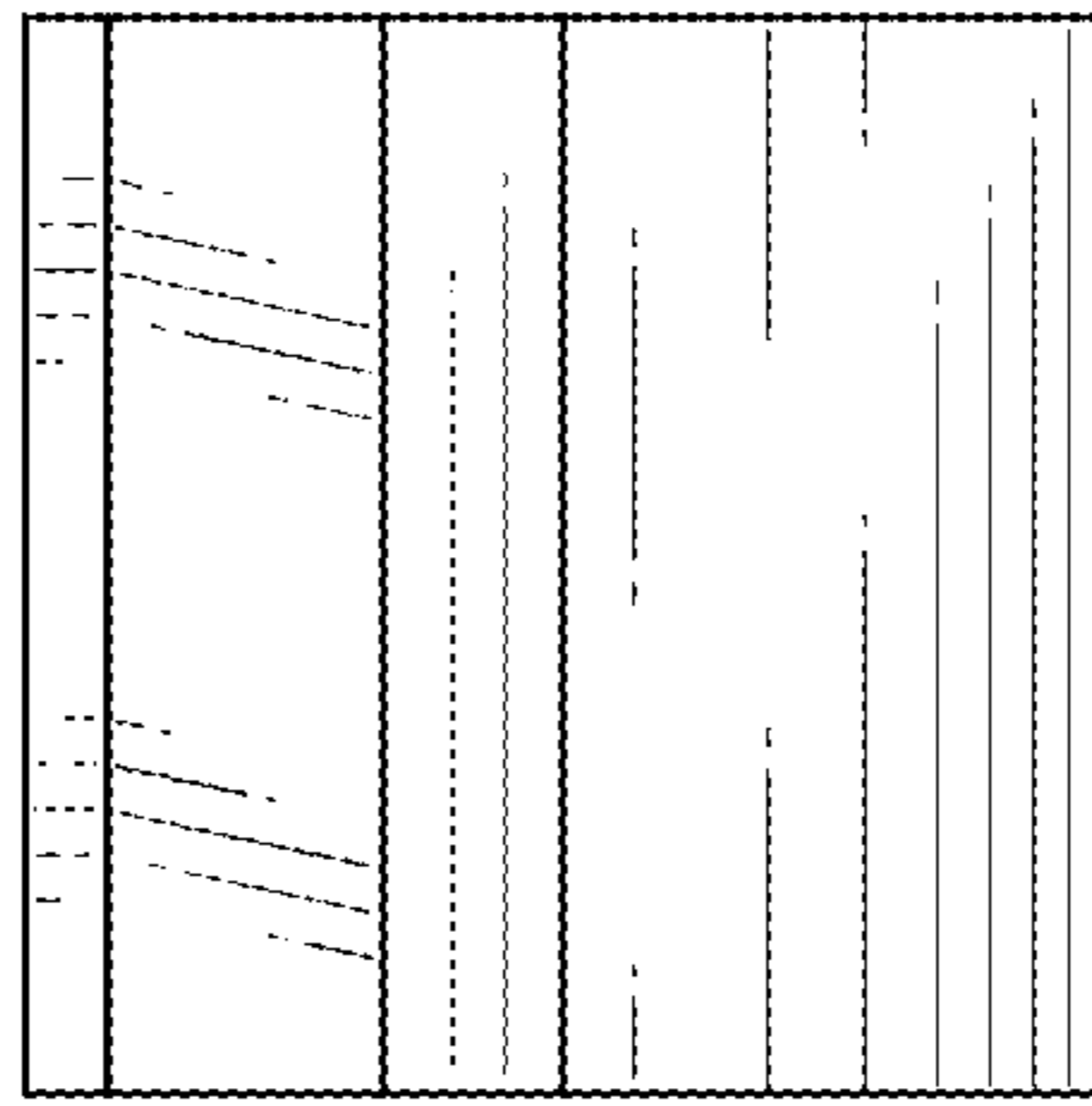

FIG. 5

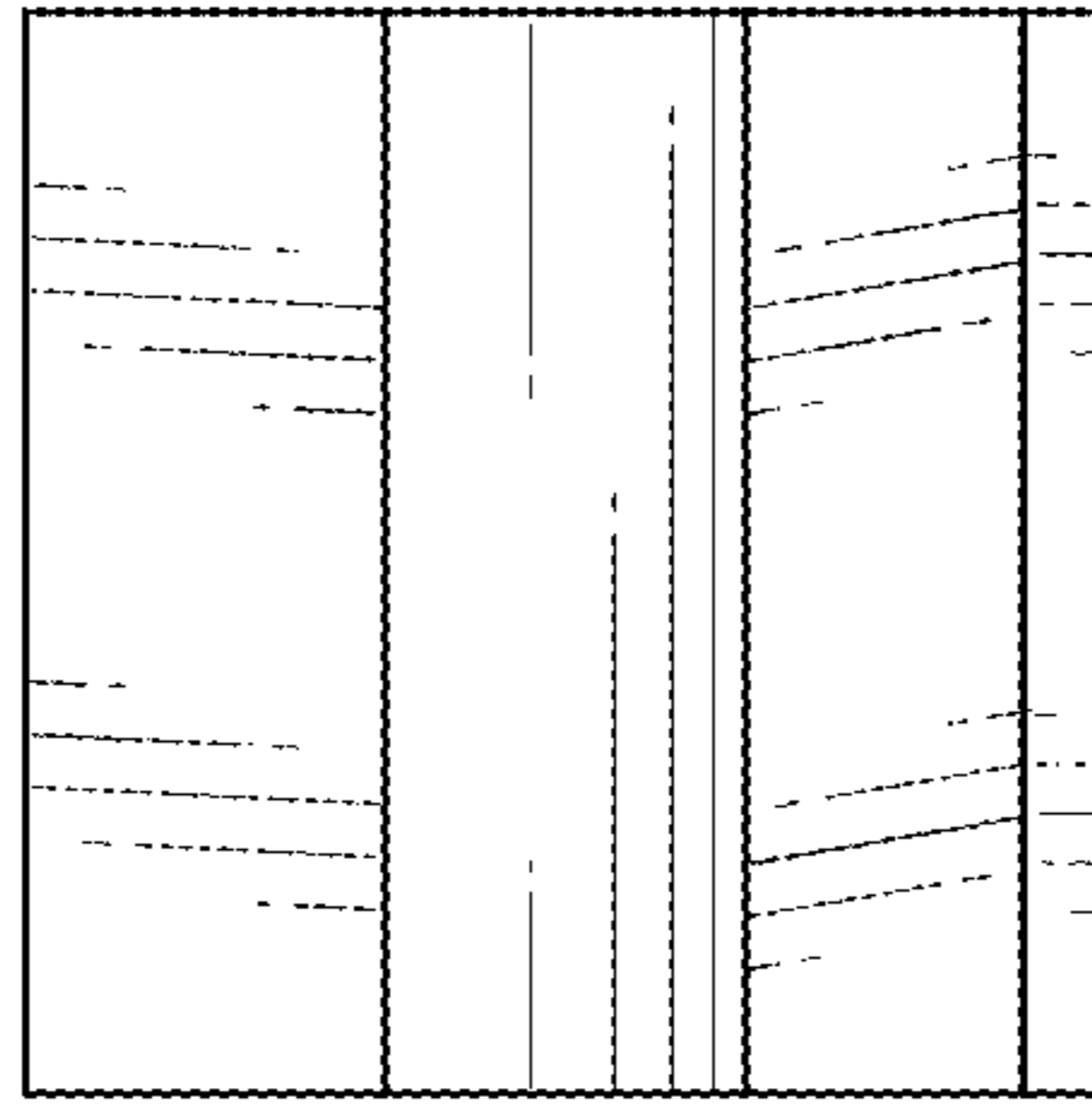

FIG. 6

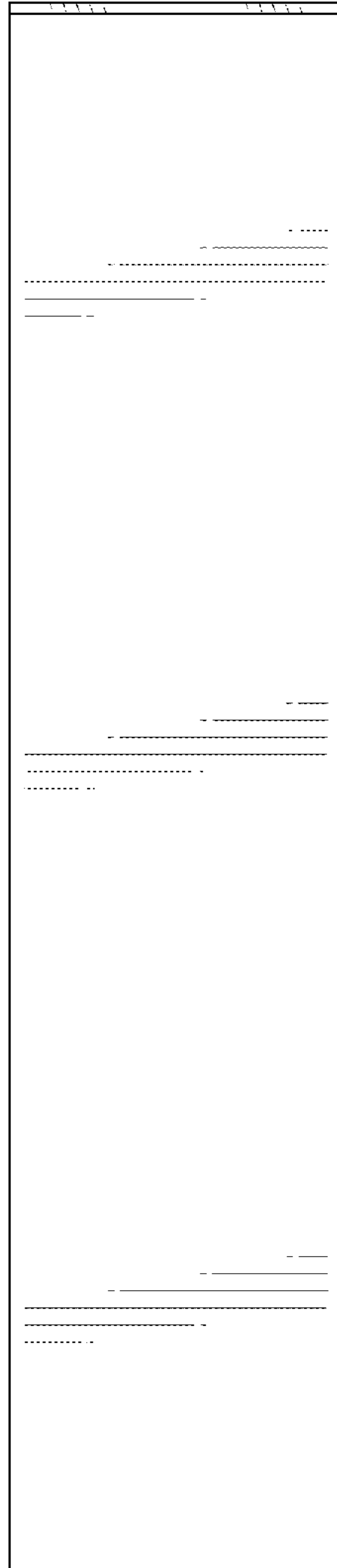

FIG. 7

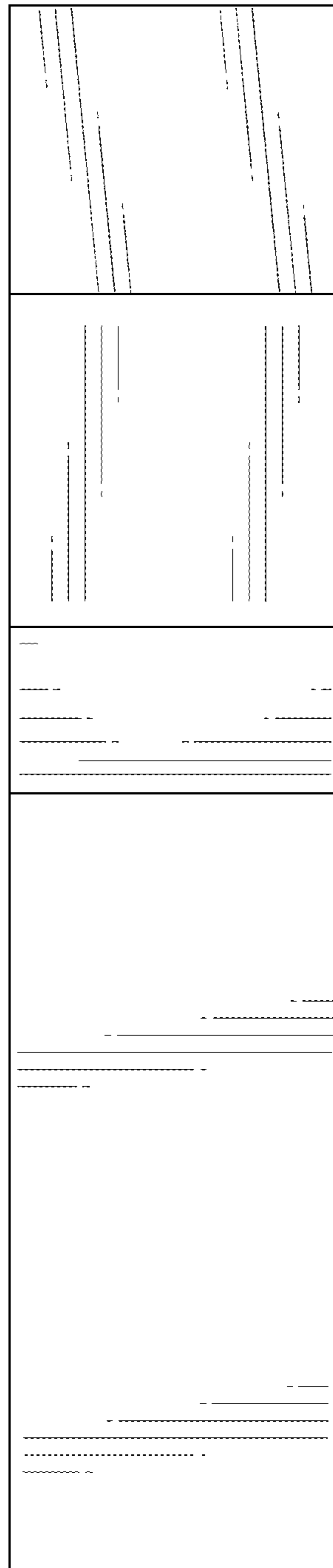

FIG. 8

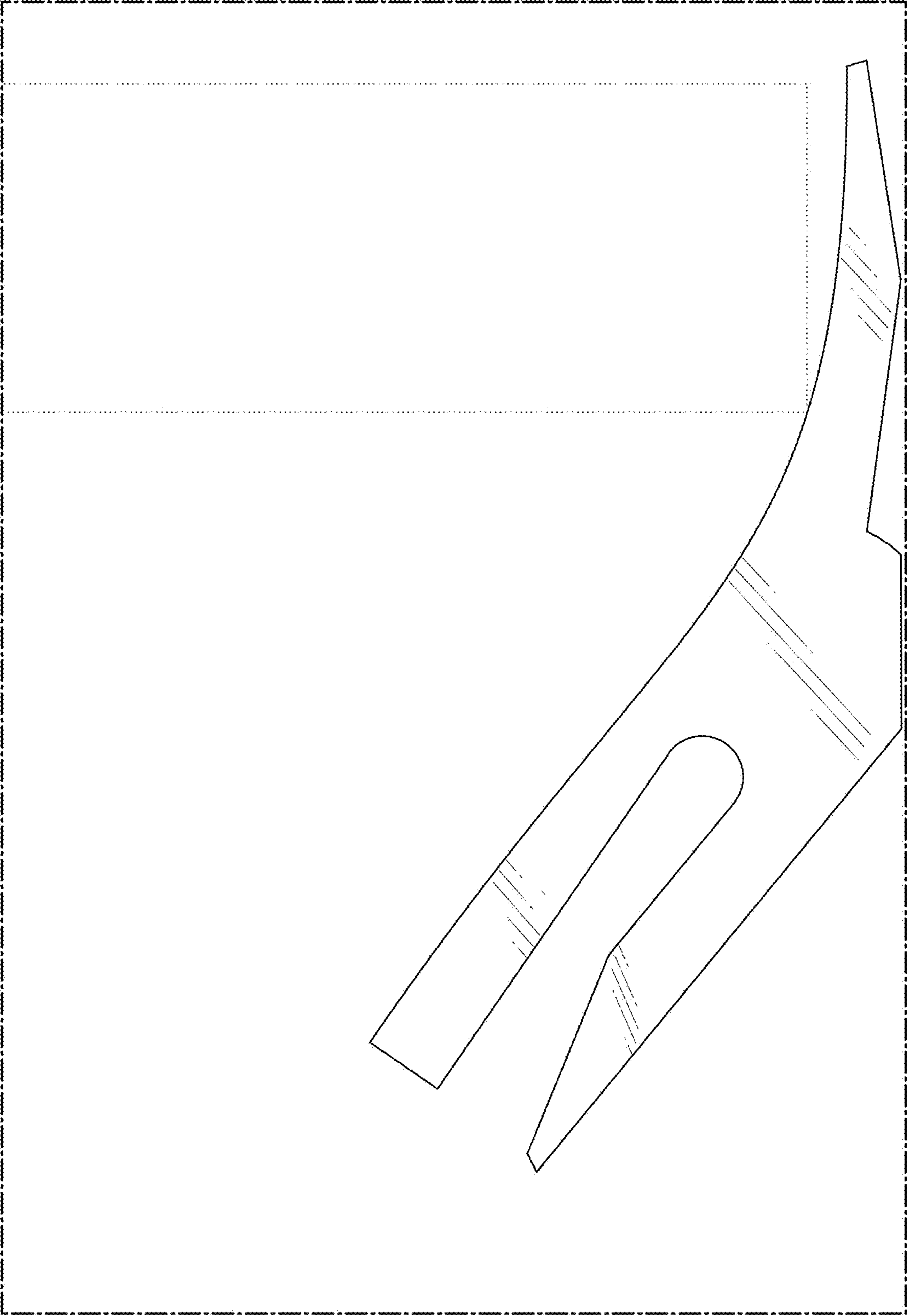

FIG. 9

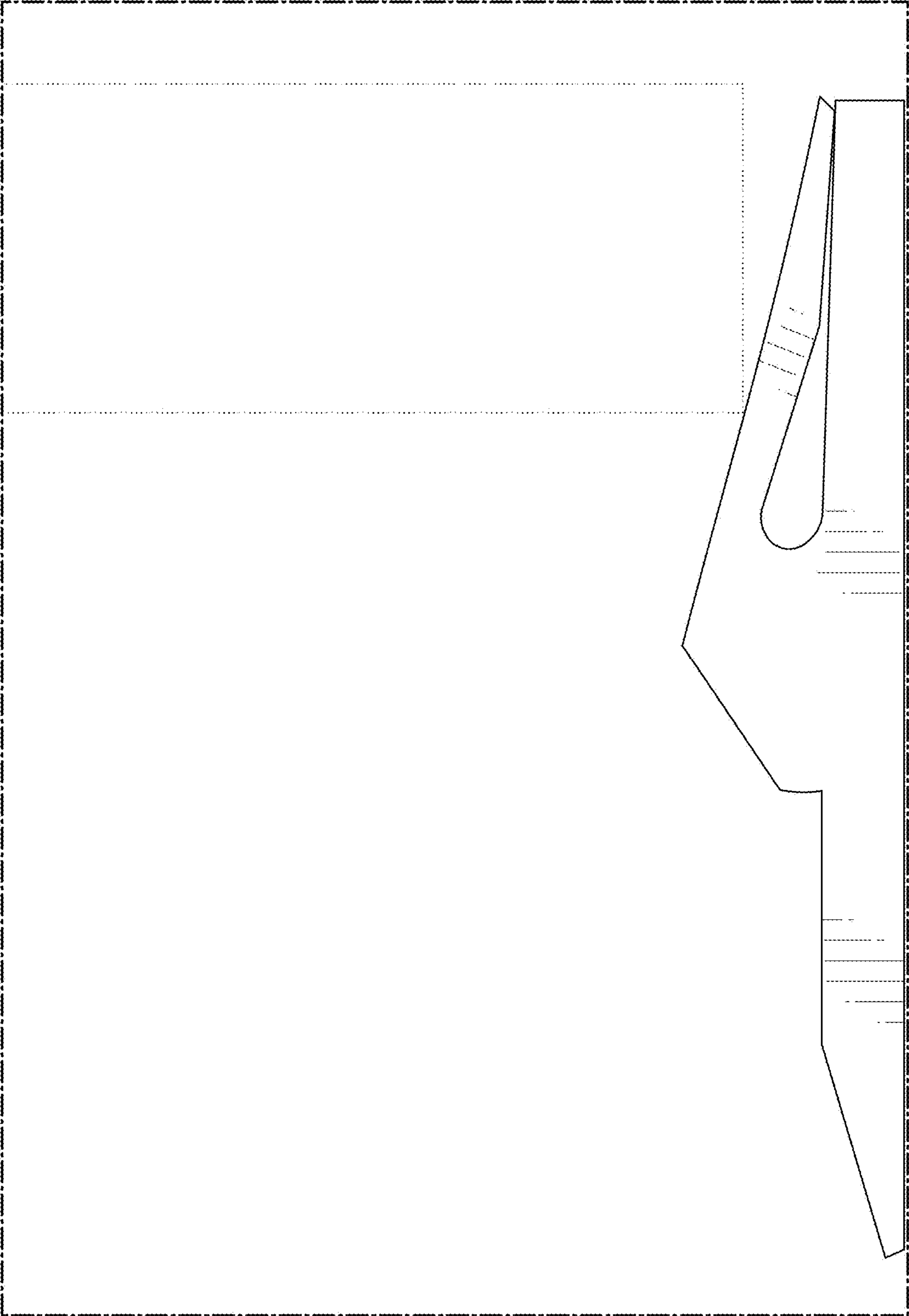

FIG. 10