



US00D957697S

(12) **United States Design Patent**  
**Wang**

(10) **Patent No.:** **US D957,697 S**  
(45) **Date of Patent:** **\*\* Jul. 12, 2022**

(54) **LED LIGHT**

(71) Applicant: **Suquan Wang**, Hangzhou (CN)

(72) Inventor: **Suquan Wang**, Hangzhou (CN)

(\*\*) Term: **15 Years**

(21) Appl. No.: **29/795,949**

(22) Filed: **Jun. 22, 2021**

(51) **LOC (13) Cl.** ..... **26-05**

(52) **U.S. Cl.**  
USPC ..... **D26/25**

(58) **Field of Classification Search**  
USPC ..... D26/1, 24, 25, 27, 40-44, 90, 113  
CPC .... F21S 8/00; F21S 8/026; F21S 8/038; F21S  
8/06; F21S 8/061; F21S 8/063; F21S  
8/065; F21S 8/068; F21S 4/00; F21S  
4/10; F21S 4/15; F21S 4/20; F21S 4/22;  
F21S 4/24; F21S 4/26; F21S 4/28  
See application file for complete search history.

(56) **References Cited**

**U.S. PATENT DOCUMENTS**

4,404,621	A *	9/1983	Mauro	.....	F21S 4/10 362/419
D406,667	S *	3/1999	Byers	.....	D11/124
D436,555	S *	1/2001	Sheridan	.....	D11/162
D459,009	S	6/2002	Chang et al.		
D917,081	S *	4/2021	Zhou	.....	D26/25
D917,083	S *	4/2021	Lamp	.....	D26/25
D918,441	S	5/2021	Liu		
D925,077	S *	7/2021	Yang	.....	D26/25
D925,783	S *	7/2021	Xiao	.....	D26/25
D935,648	S *	11/2021	Shi	.....	D26/25

**OTHER PUBLICATIONS**

Tropical Flamingo Decorative LED Light Party Lamp, Sasse Belle, <https://www.amazon.de/-/en/Tropical-Flamingo-Decorative-Light-Rockabilly/dp/B01CYU5P9O>, Nov. 9, 2016 (Year: 2016).\*

\* cited by examiner

*Primary Examiner* — Richard Kearney  
*Assistant Examiner* — Benjamin M Weeks

(57) **CLAIM**

The ornamental design for an LED light, as shown and described.

**DESCRIPTION**

FIG. 1 is a perspective view of a first embodiment of an LED light showing my new design;  
FIG. 2 is another perspective view thereof;  
FIG. 3 is a front elevational view thereof;  
FIG. 4 is a rear elevational view thereof;  
FIG. 5 is a left side elevational view thereof;  
FIG. 6 is a right side elevational view thereof;  
FIG. 7 is a top plan view thereof;  
FIG. 8 is a bottom plan view thereof; and,  
FIG. 9 is an enlarged view of portion 9 shown in FIG. 1.  
The broken lines in the drawings depict portions of the LED light that form no part of the claimed design. The LED light is shown with symbolic breaks in its length and the appearance of any portion of the LED light between the break lines form no part of the claimed design.

**1 Claim, 9 Drawing Sheets**

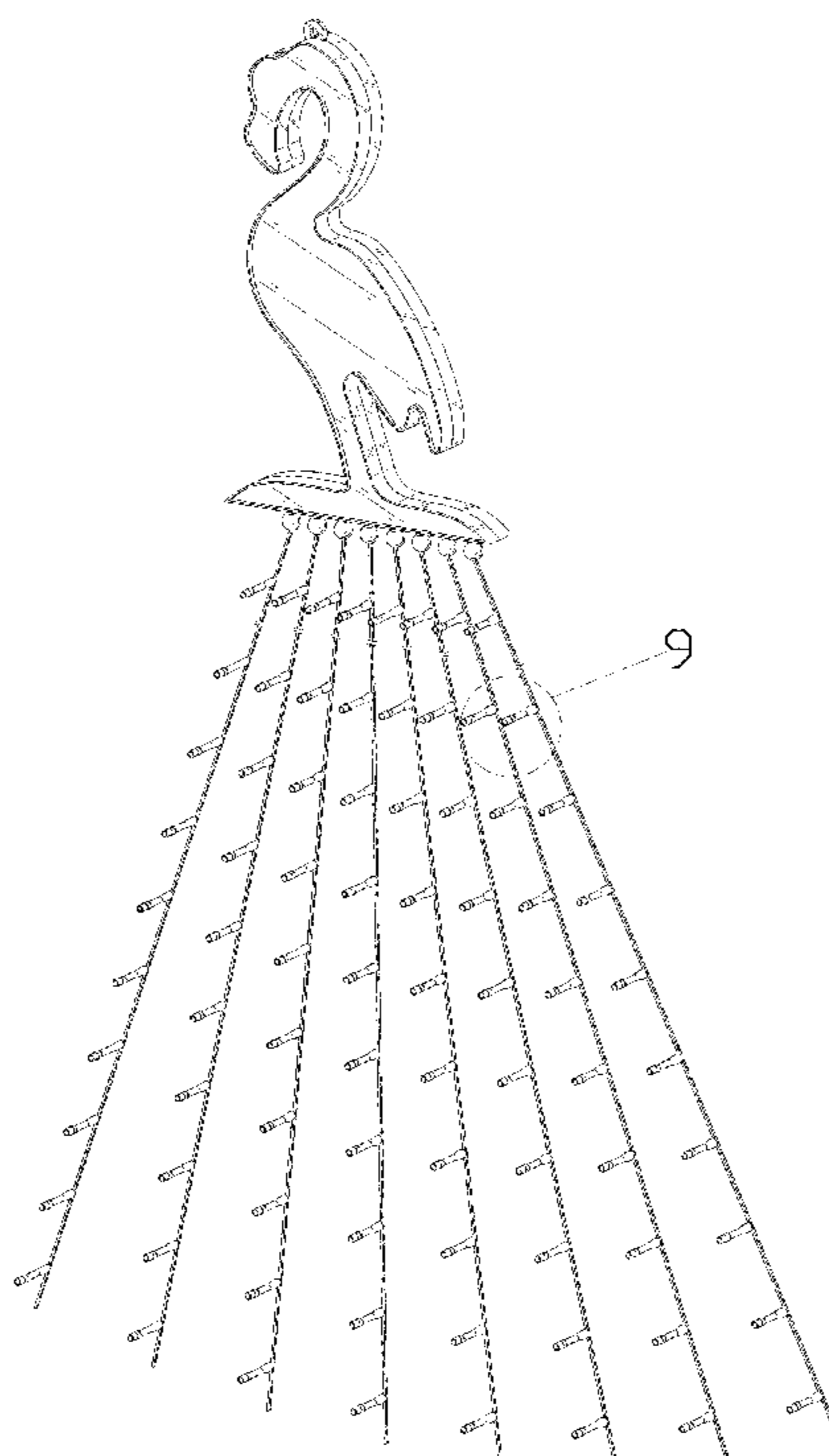

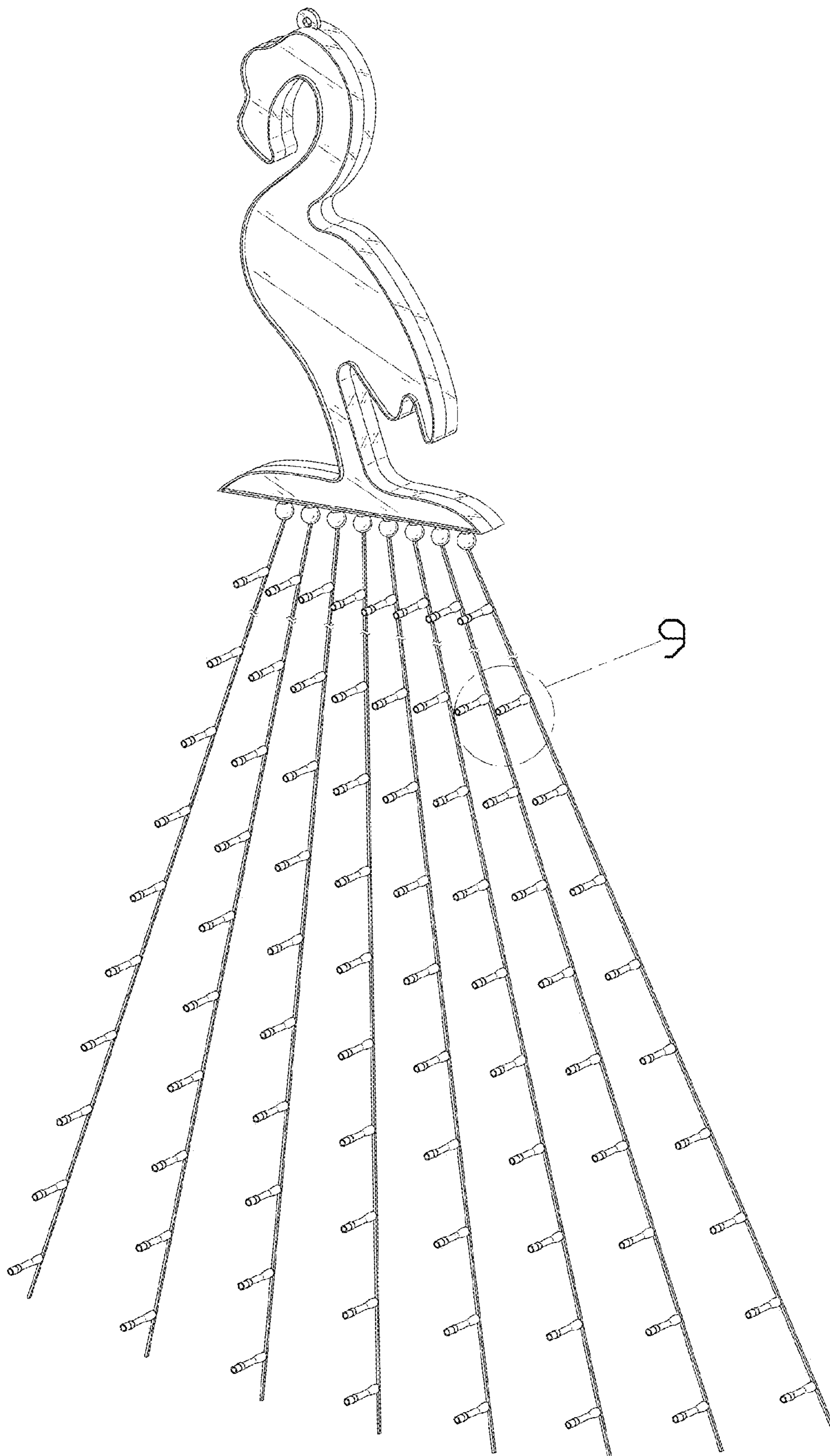

FIG. 1

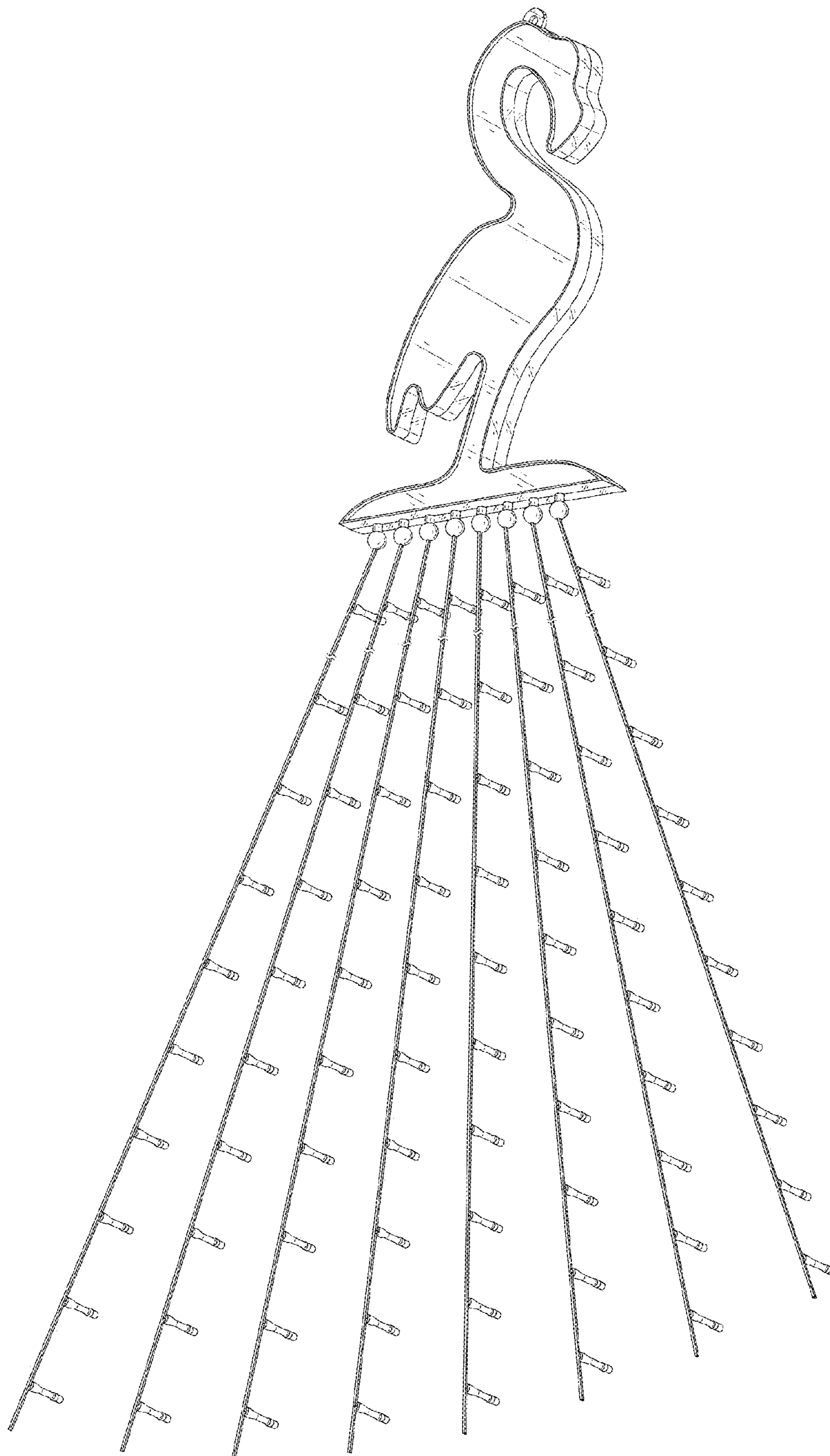

FIG. 2

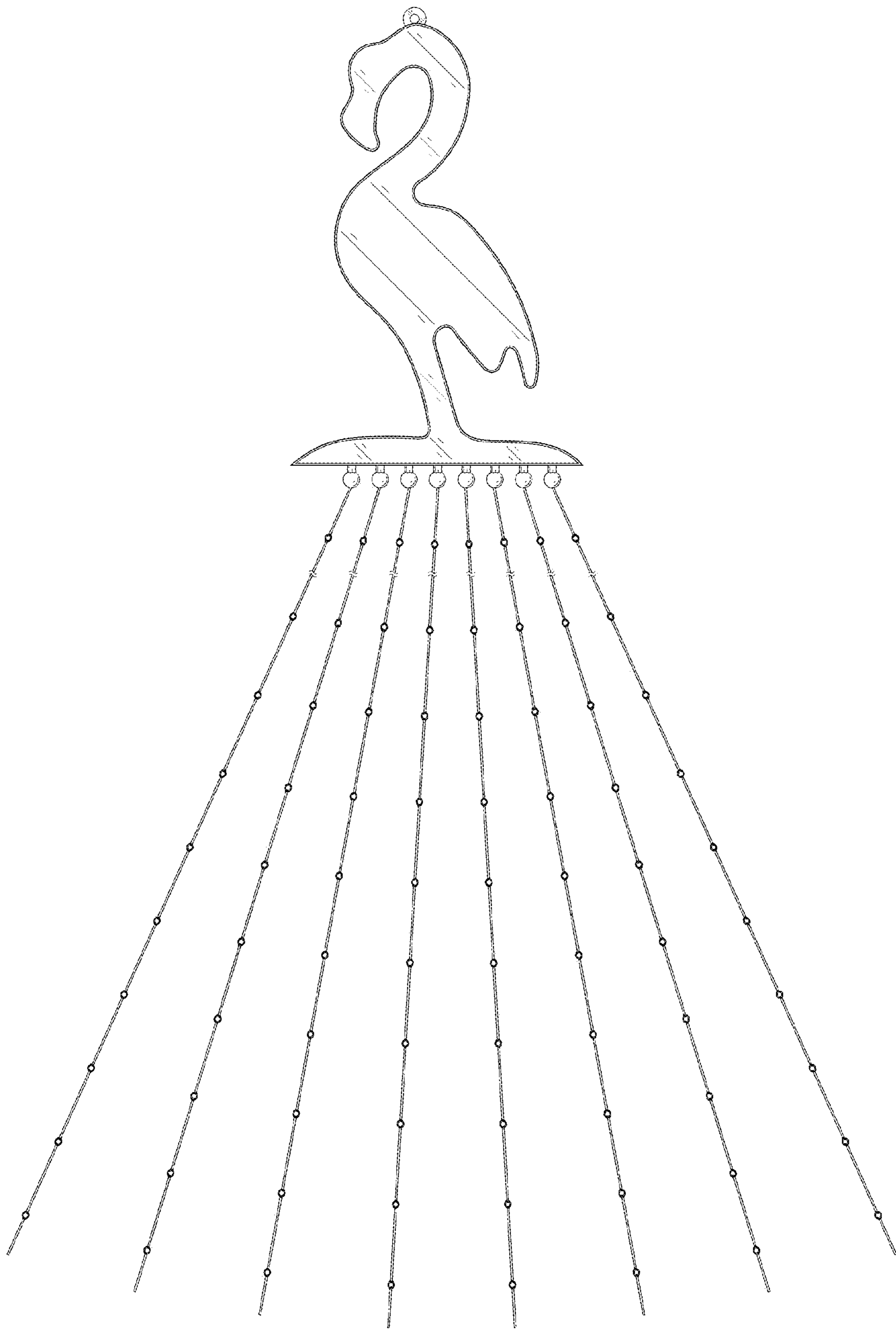

FIG. 3

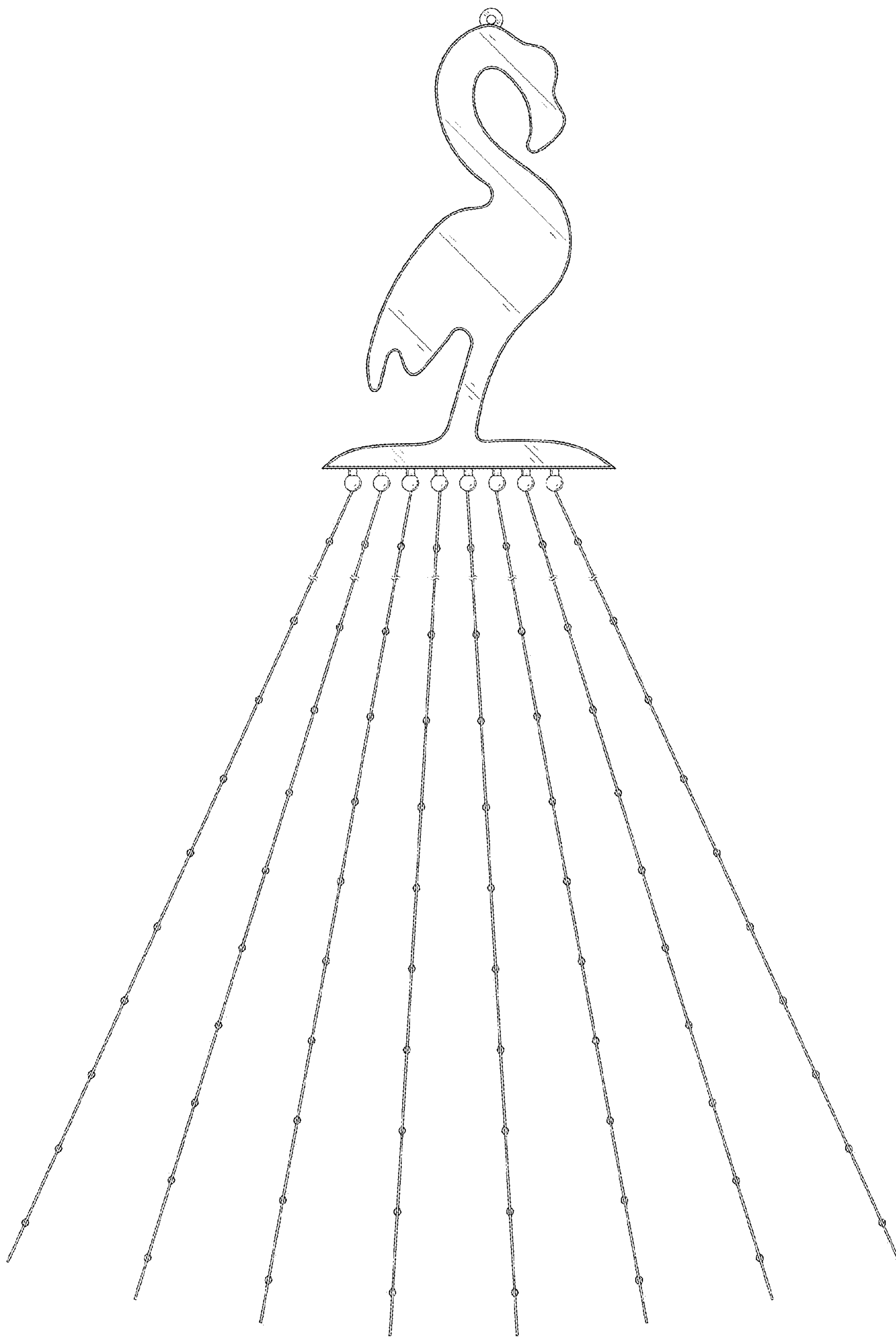

FIG. 4

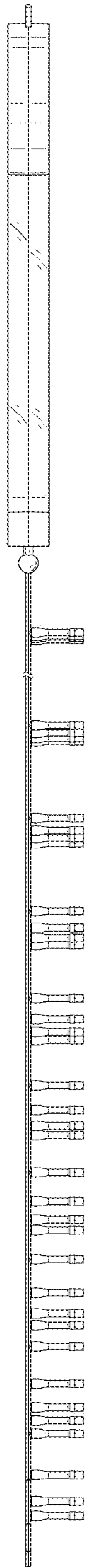

FIG. 5

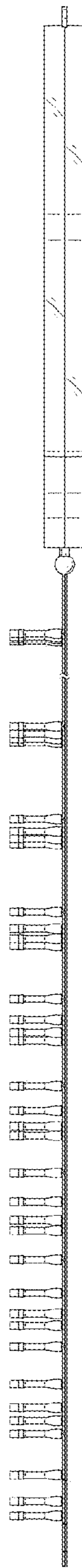

FIG. 6

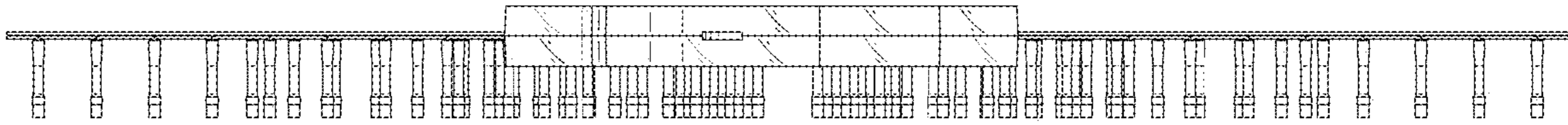

FIG. 7



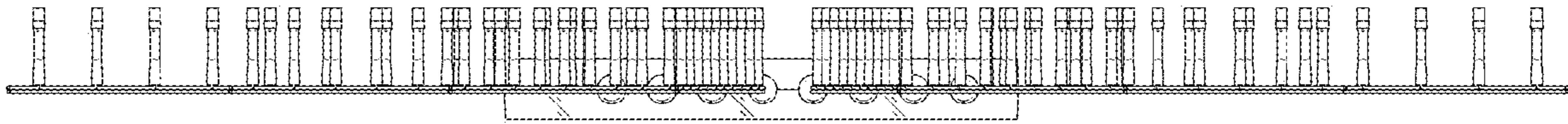

FIG. 8

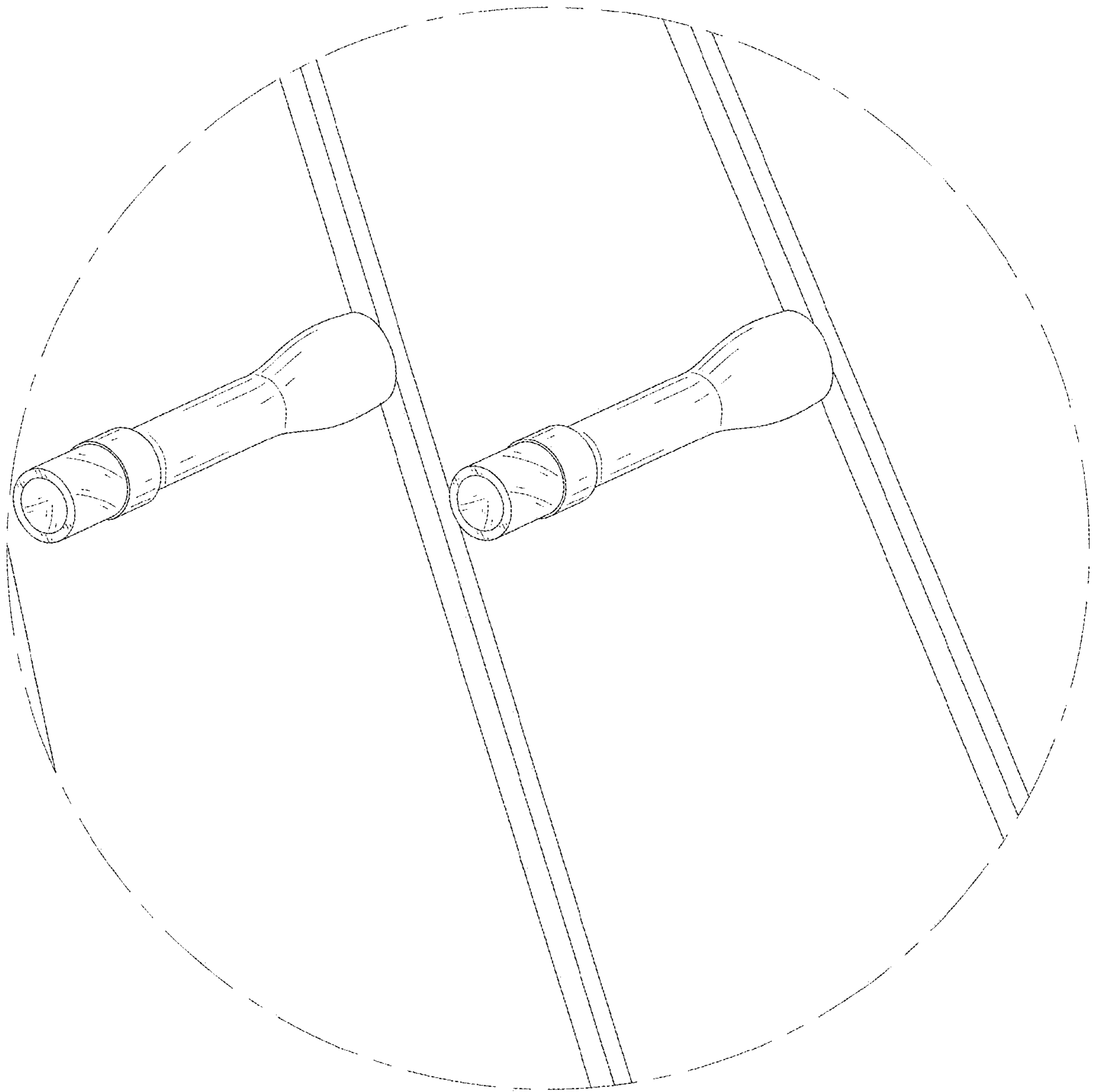

FIG. 9