



US00D957695S

(12) **United States Design Patent**
Ou Yang

(10) **Patent No.:** **US D957,695 S**
(45) **Date of Patent:** **** Jul. 12, 2022**

- (54) **ULTRAVIOLET STERILIZING LIGHT BULB**
- (71) Applicant: **SHENZHEN UVLED OPTICAL TECHNOLOGY CO., LTD.**, Shenzhen (CN)
- (72) Inventor: **Chen Yi Ou Yang**, Ningyuan County (CN)
- (73) Assignee: **SHENZHEN UVLED OPTICAL TECHNOLOGY CO., LTD.**, Shenzhen (CN)

D698,050 S *	1/2014	Jiang	D26/2
D740,873 S *	10/2015	Scalisi	D16/203
D800,928 S *	10/2017	Xu	D26/2
D830,571 S *	10/2018	Ghahary	D24/217
D832,469 S *	10/2018	Wei	D26/2
D838,869 S *	1/2019	Schaack	D26/2
D854,197 S *	7/2019	Benner	D26/2
D897,564 S *	9/2020	Chen	D26/2
10,823,369 B2 *	11/2020	Marry	F21K 9/00
D905,875 S *	12/2020	Choi	D26/2
D936,865 S *	11/2021	Athalye	F21V 29/83
				D26/2
D937,447 S *	11/2021	Ou Yang	D26/2

- (**) Term: **15 Years**
- (21) Appl. No.: **29/746,158**
- (22) Filed: **Aug. 12, 2020**

(30) **Foreign Application Priority Data**

Jul. 16, 2020 (CN) 202030387731.2

- (51) **LOC (13) Cl.** **26-04**
- (52) **U.S. Cl.**
USPC **D26/2**

- (58) **Field of Classification Search**
USPC D24/107, 186, 200, 209–213, 217–219,
D24/224–232; D32/1, 25; D23/366;
D26/1–4
CPC ... A61L 2/26; A61L 2/10; A61L 2/025; A61L
2202/10; A61L 2202/11; A61L 2202/23;
A61L 2202/122
See application file for complete search history.

(56) **References Cited**

U.S. PATENT DOCUMENTS

D461,573 S *	8/2002	Oetken	D26/2
D635,281 S *	3/2011	Murakami	D26/2

OTHER PUBLICATIONS

Lighting series, posted at 59S.com, no posting date, retrieved Dec. 16, 2021, online, URL: <https://www.59s.com/collections/lighting-series> (Year: 2021).*

* cited by examiner

Primary Examiner — Mary Shannon Malley
(74) *Attorney, Agent, or Firm* — Li & Cai Intellectual Property (USA) Office

(57) **CLAIM**

The ornamental design for an ultraviolet sterilizing light bulb, as shown and described.

DESCRIPTION

FIG. 1 is a front, right side and bottom perspective view of an ultraviolet sterilizing light bulb showing my new design; FIG. 2 is a front elevational view thereof; FIG. 3 is a rear elevational view thereof; FIG. 4 is a left side elevational view thereof; FIG. 5 is a right side elevational view thereof; FIG. 6 is a top plan view thereof; and, FIG. 7 is a bottom plan view thereof.

1 Claim, 7 Drawing Sheets

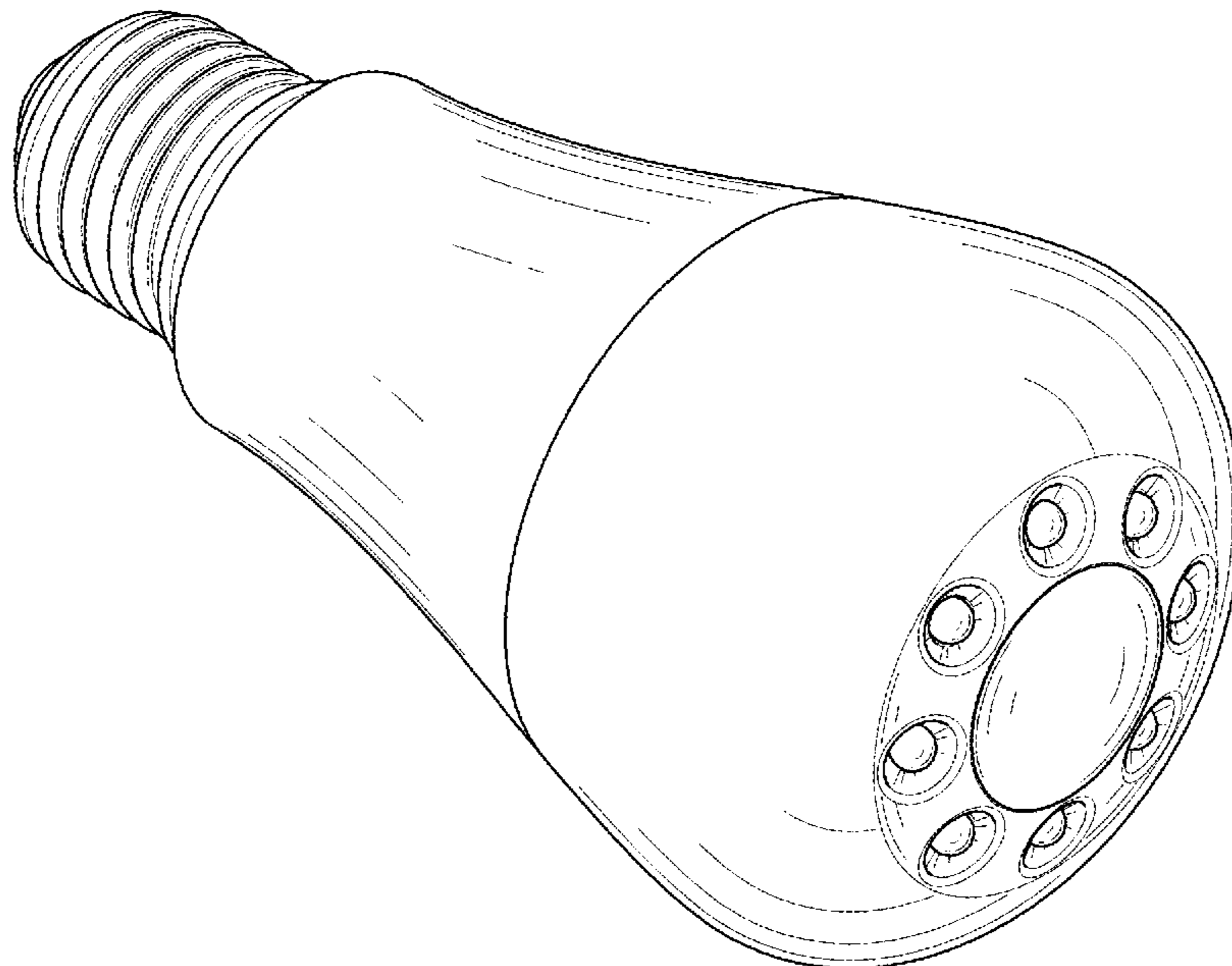

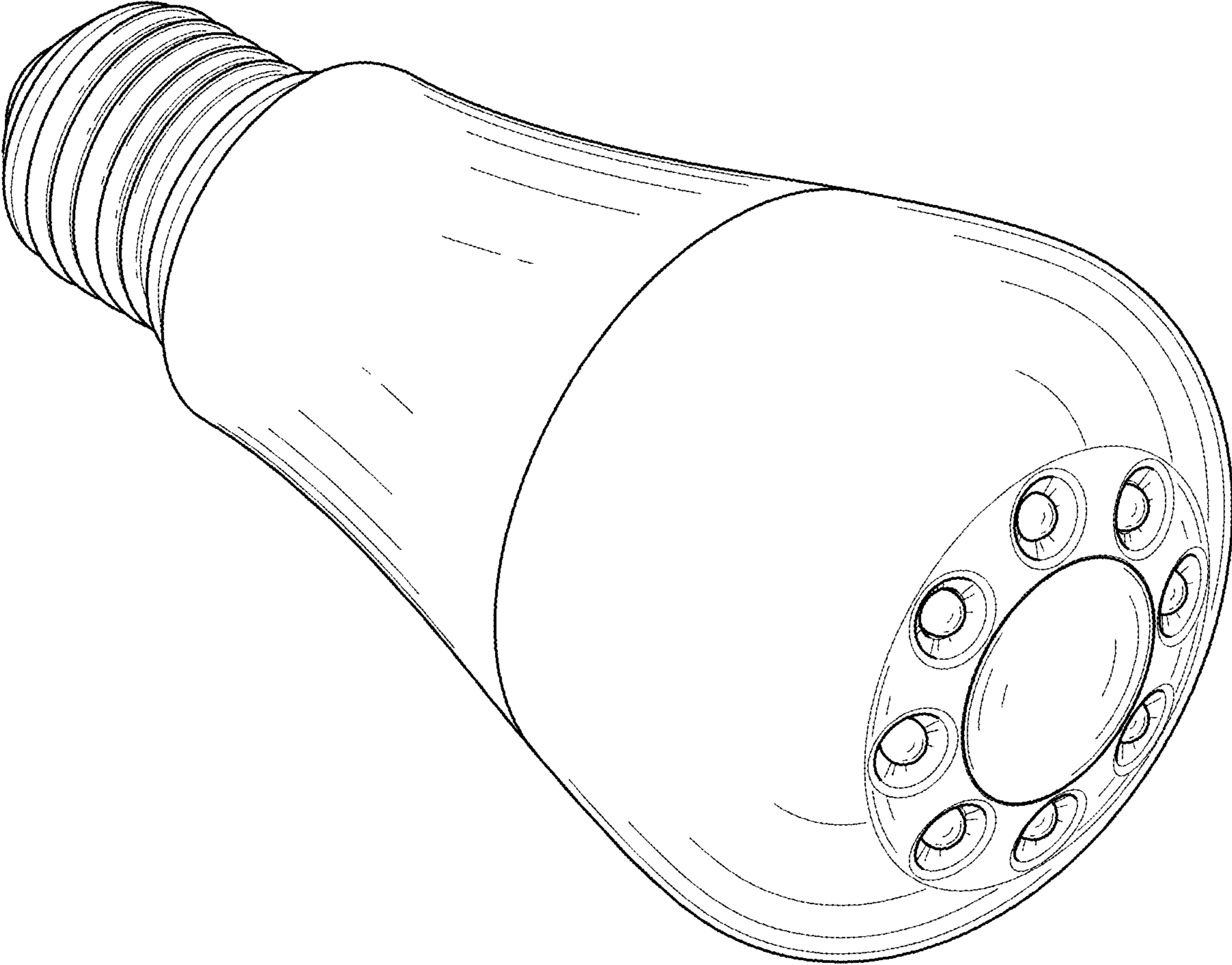

FIG. 1

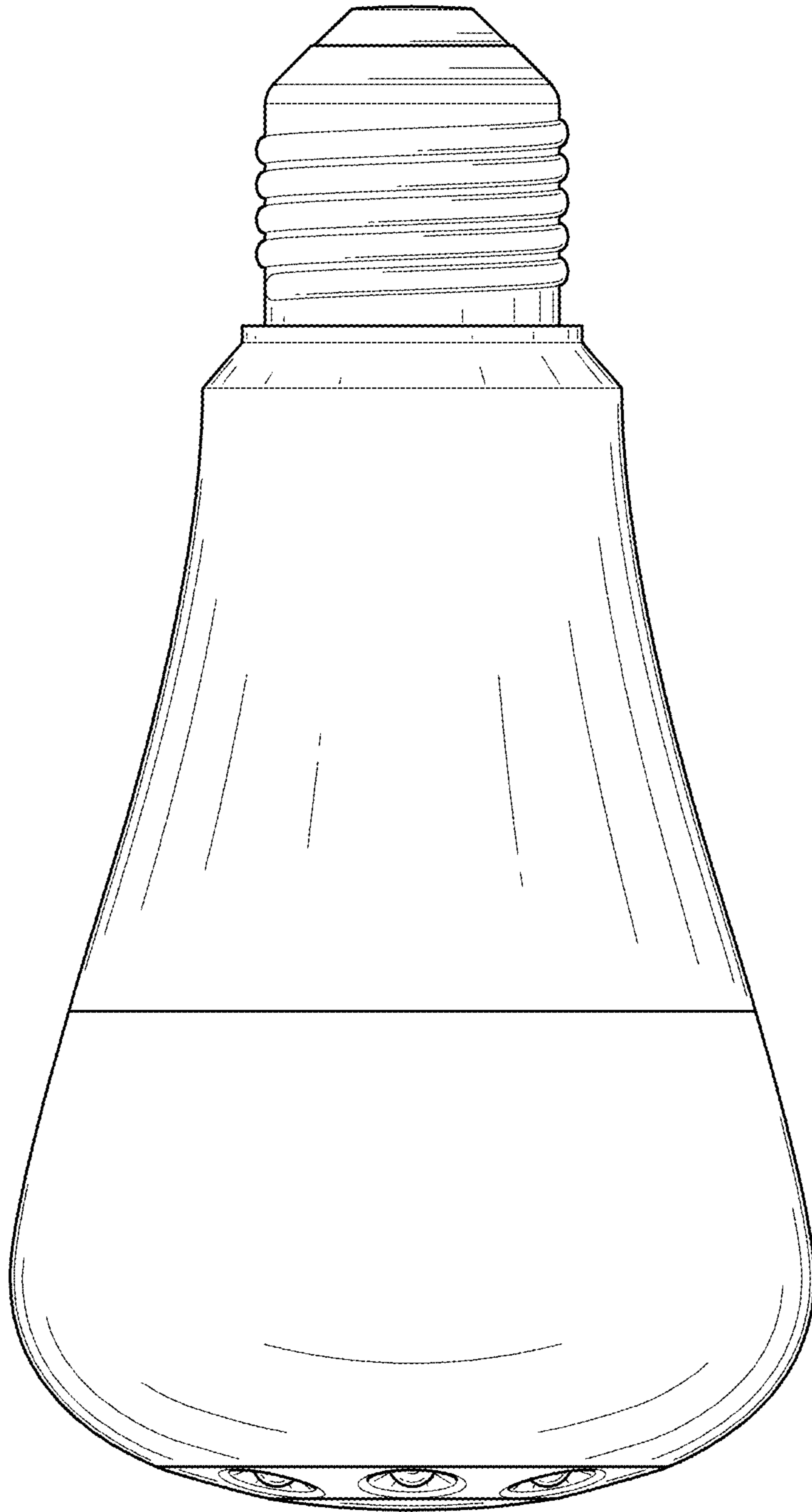

FIG. 2

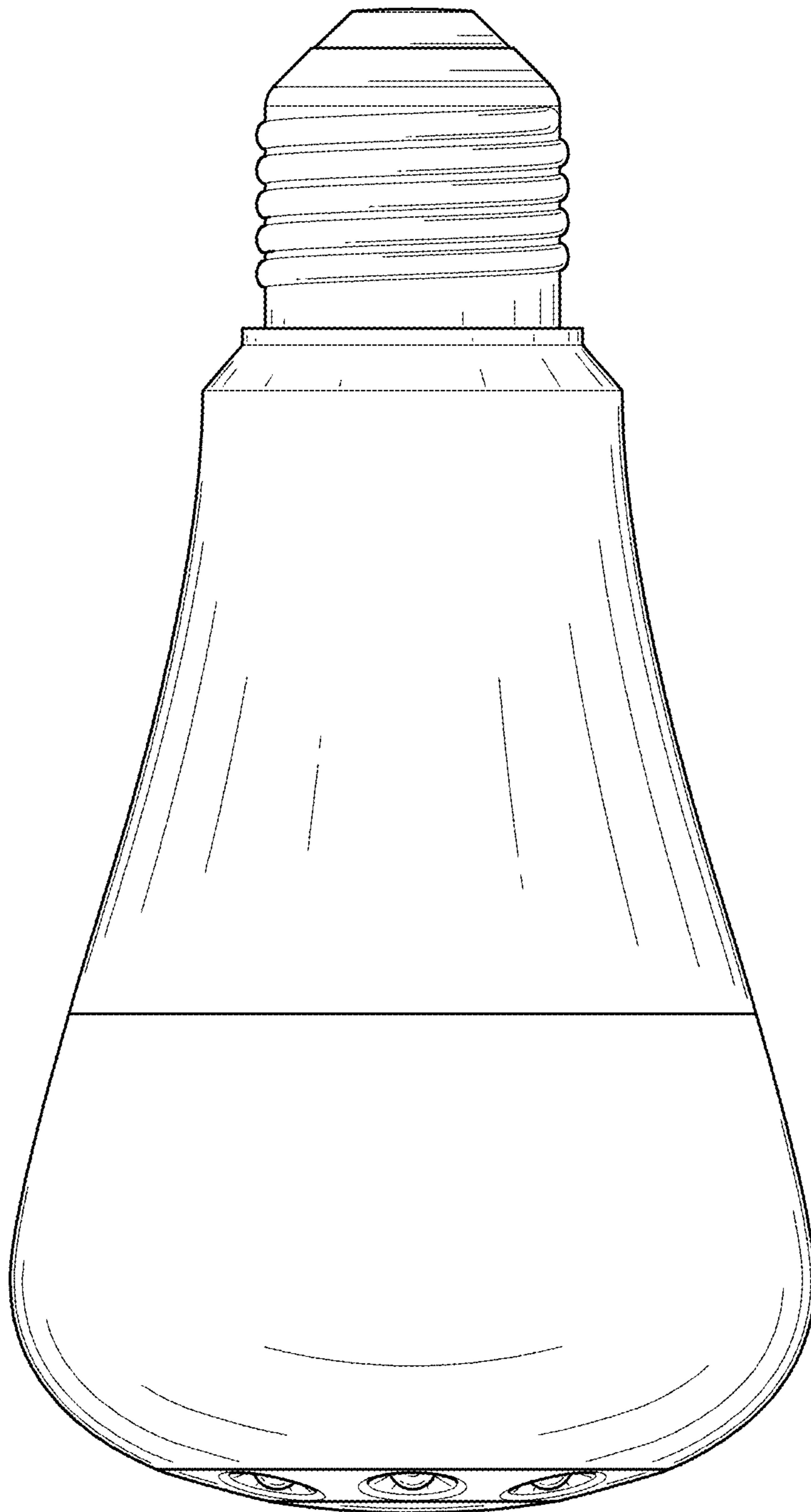

FIG. 3

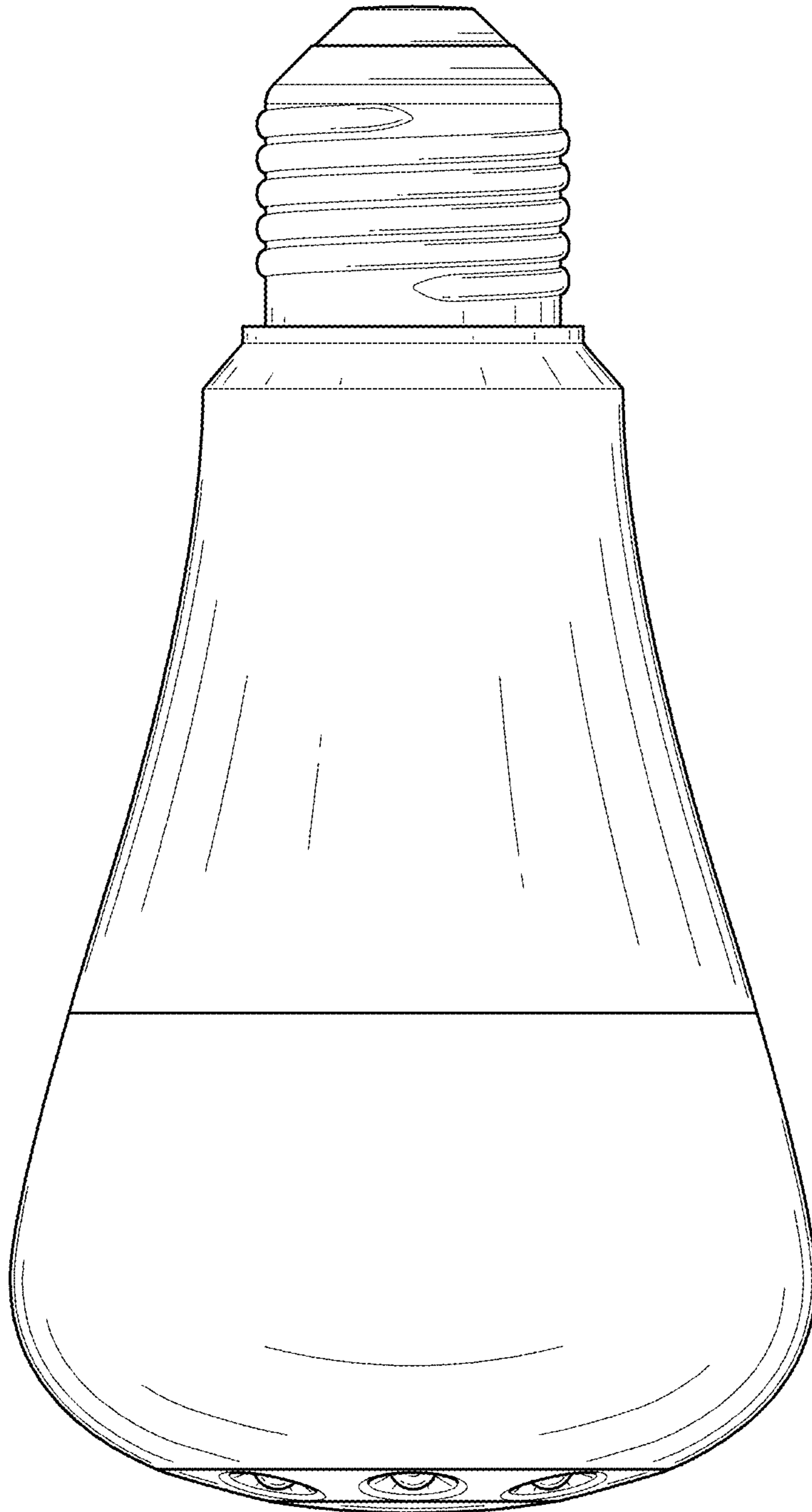

FIG. 4

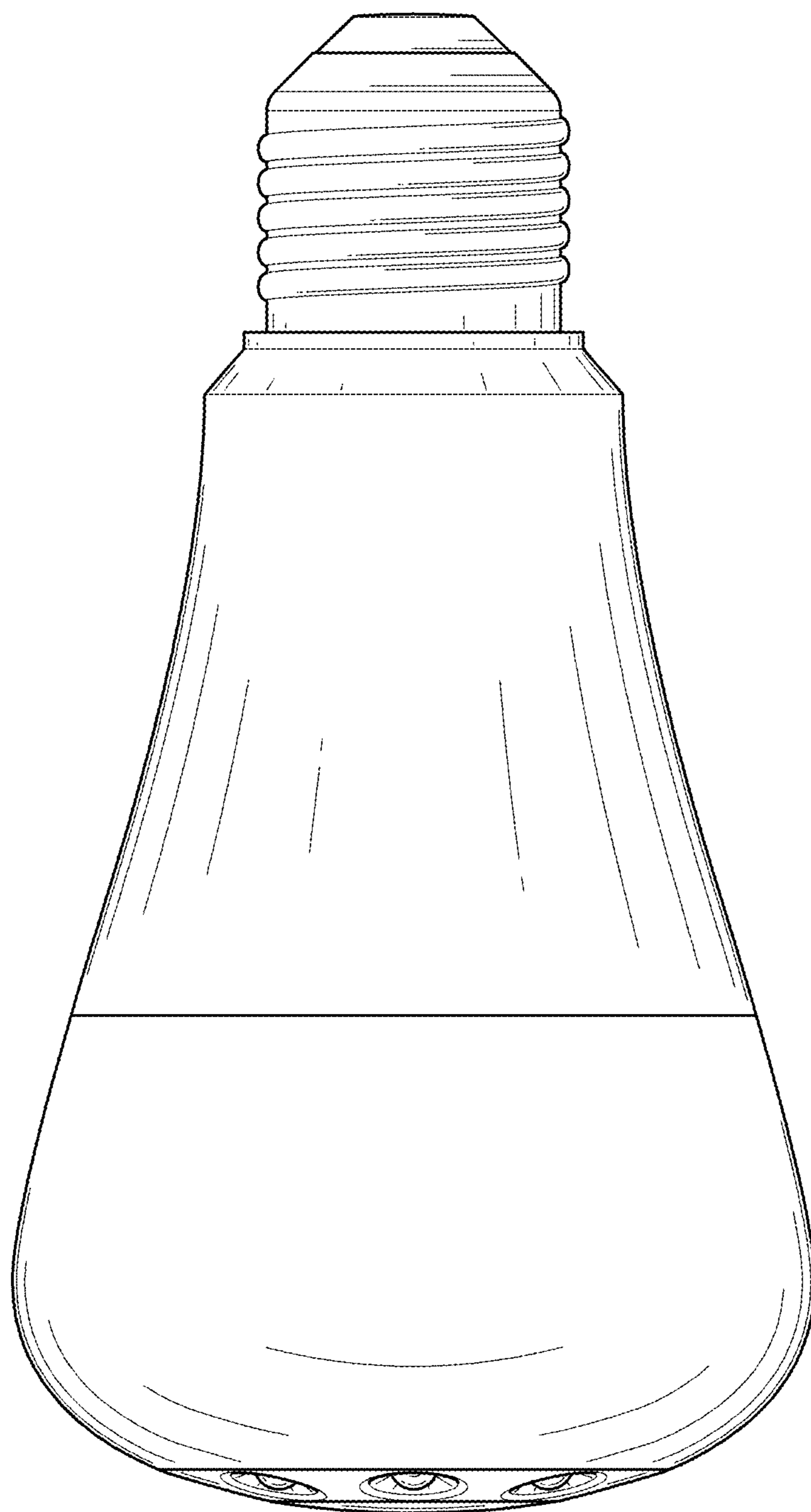

FIG. 5

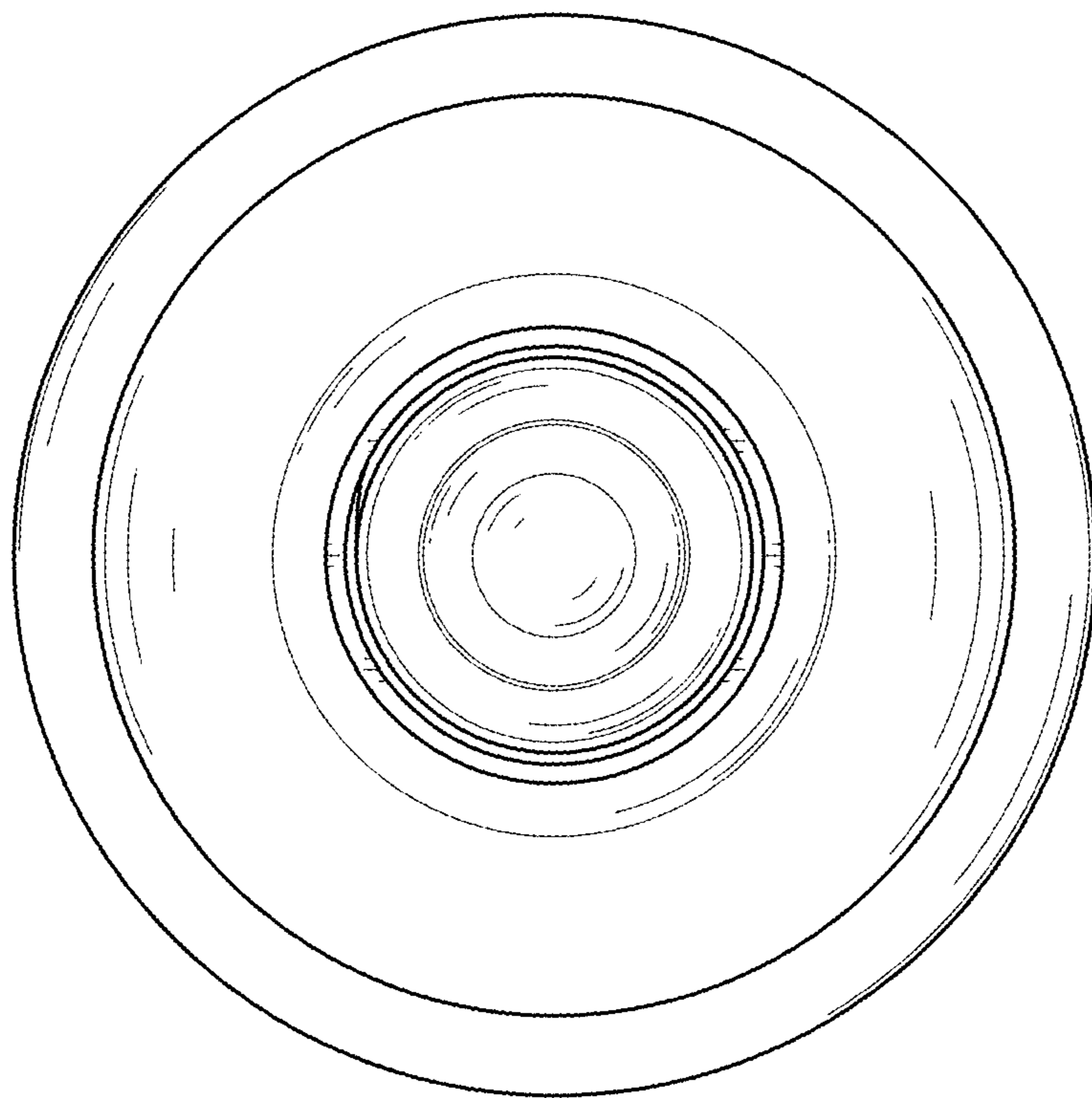

FIG. 6

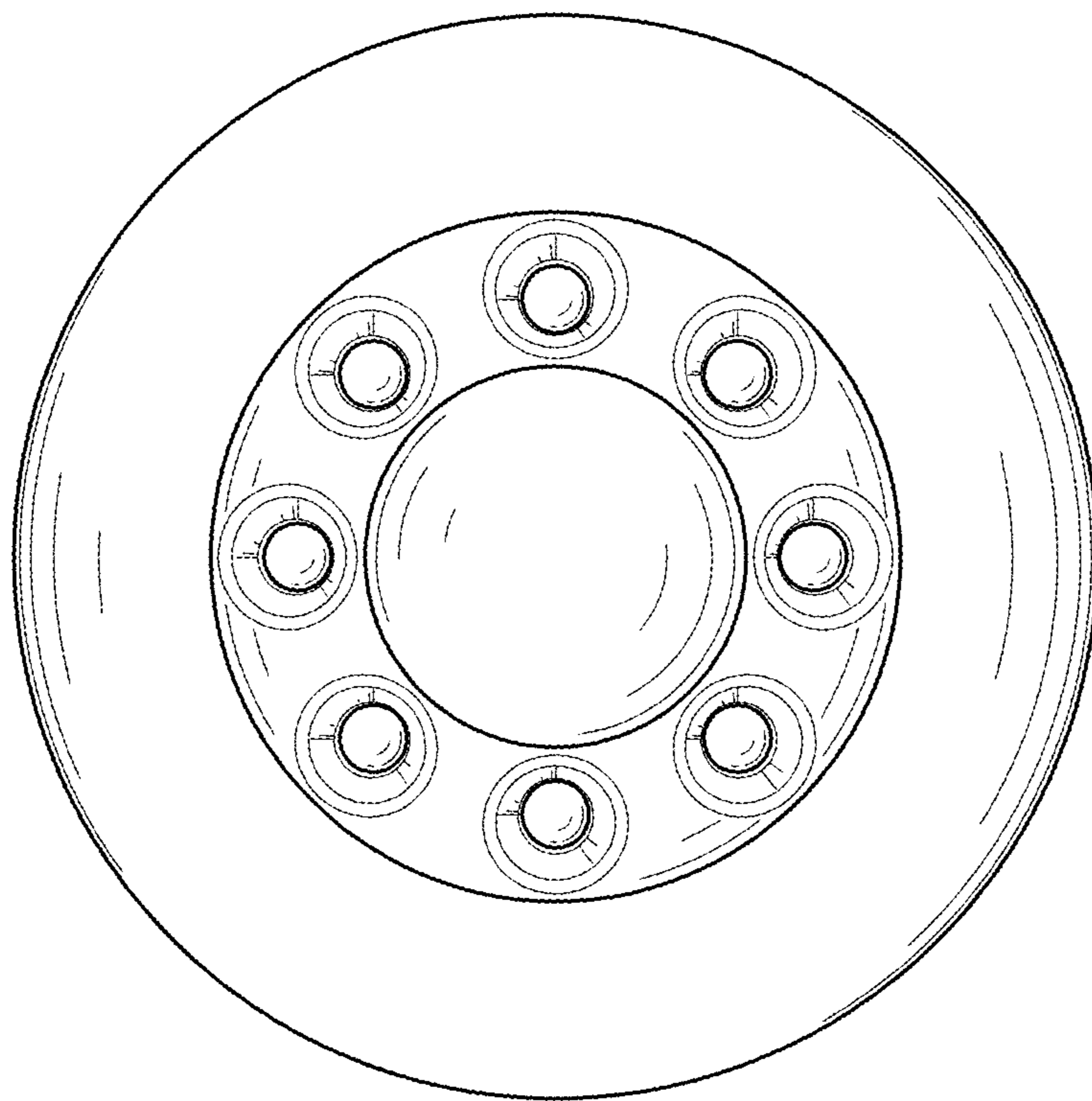

FIG. 7