



US00D957628S

(12) **United States Design Patent**
Abdaoui

(10) **Patent No.:** **US D957,628 S**
(45) **Date of Patent:** **** Jul. 12, 2022**

(54) **HANDLE FOR SWAB**

(71) Applicant: **Youcef Abdaoui**, Epinay-sur-Seine (FR)

(72) Inventor: **Youcef Abdaoui**, Epinay-sur-Seine (FR)

(**) Term: **15 Years**

(21) Appl. No.: **29/730,554**

(22) Filed: **Apr. 6, 2020**

(30) **Foreign Application Priority Data**

Oct. 4, 2019 (EM) 006978391-0001

(51) **LOC (13) Cl.** **24-02**

(52) **U.S. Cl.**
USPC **D24/119**

(58) **Field of Classification Search**

USPC 600/562, 564, 566-567; 604/1; 606/162;
D14/152, 1; D16/130, 132, 136;
D19/96; D23/303, 304, 305; D24/100,
D24/105, 107-108, 110-119, 10.5,
D24/127-130, 144-149, 132-135,
D24/137-138, 140-141, 152, 172-174,
D24/176, 185-186, 208, 211, 214-215,
D24/220, 222; D28/30-31, 76, 85, 99,
D28/7-8; D32/45, 51; D4/101, 104-105,
D4/108, 110-114, 132, 137-138;

(Continued)

(56) **References Cited**

U.S. PATENT DOCUMENTS

D356,213 S * 3/1995 Chaves D4/102
D438,789 S * 3/2001 Choe D28/20

(Continued)

FOREIGN PATENT DOCUMENTS

CN 202030126450.1 * 4/2020

OTHER PUBLICATIONS

Q Grips Ear Wax Remover Smart Spiral Swab Ear Cleaner, first available Oct. 20, 2020, amazon.com, [online], [site visited Aug. 4, 2021], Available from internet URL: https://www.amazon.com/dp/B08LFW9C9R/ref=sspa_dk_detail_6?psc=1&pd_rd_i=B08LFW9C9R&pd_rd_w=zi1XM&pf_rd_p=9fd3ea7c-b77c-42ac-b4%E2%80%A6 (Year: 2021).*

(Continued)

Primary Examiner — Samantha Q Lawrence

Assistant Examiner — Holly M Rodriguez

(74) *Attorney, Agent, or Firm* — Pillsbury Winthrop Shaw Pittman, LLP

(57) **CLAIM**

The ornamental design for handle for swab, as shown and described.

DESCRIPTION

FIG. 1 is a line-drawing perspective-view of a handle for a swab, showing my new design from a first perspective; FIG. 2 is a line-drawing perspective-view of the handle for the swab of FIG. 1, showing my new design from a second perspective;

FIG. 3 is a line-drawing plan-view of the handle for the swab of FIG. 1, showing my new design from the top;

FIG. 4 is a line-drawing plan-view of the handle for the swab of FIG. 1, showing my new design from the bottom;

FIG. 5 is a line-drawing elevation-view of the handle for the swab of FIG. 1, showing my new design from a first side; and,

FIG. 6 is a line-drawing elevation-view of the handle for the swab of FIG. 1, showing my new design from a second side, opposite the first side.

Portions of the article not shown in the drawing form no part of the claimed design. Color forms no part of the claimed design.

1 Claim, 6 Drawing Sheets

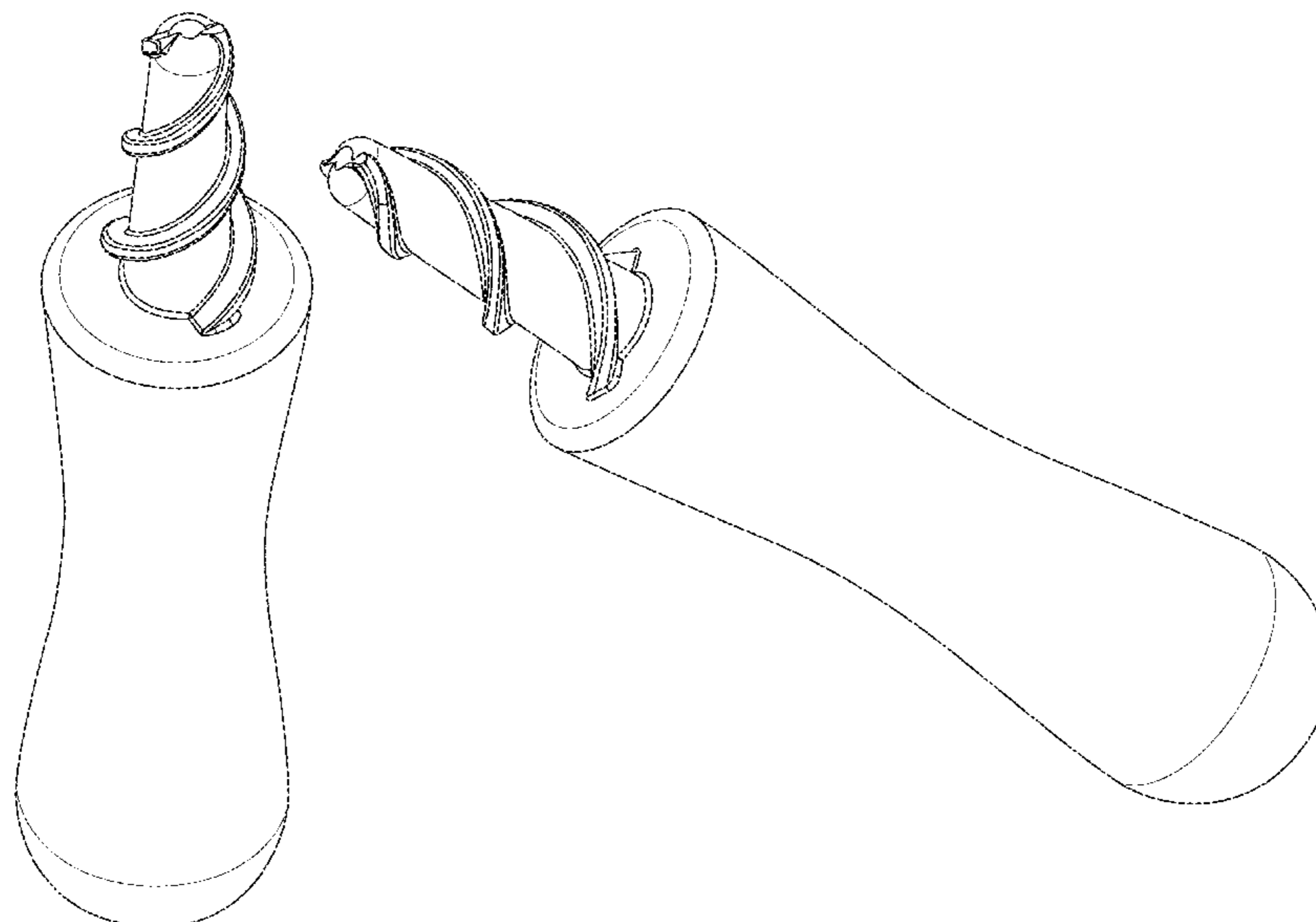

(58) **Field of Classification Search**

USPC D8/98–100, 105, 14, 17, 20, 305,
 D8/315–316, 47
 CPC A46B 15/00; A46B 15/0075; A46B 5/04;
 A46B 15/0069; A46B 15/0071; A46B
 220/1066; A61H 13/00; A61H 220/0153;
 A61H 19/00; A61H 19/40; A61H
 2205/087; A61H 39/08; A46D 5/02;
 A47G 21/00; B65D 51/32; A61F
 2013/15243; A61F 13/49001; A61F
 11/006; A61F 13/36; A61F 13/38; A61F
 9/00709; A61F 2013/4587; A61F
 2013/53035; A61B 17/046004; A61B
 2017/06028; A61B 17/06066; A61B
 17/0401; A61B 17/06109; A61B 17/0625;
 A61B 17/062; A61B 2017/0409; A61B
 17/0469; A61B 2017/0445; A61B 17/04;
 A61B 2017/06042; A61B 17/06; A61B
 17/244; A61B 13/00; A61B 2017/00398;
 C09D 183/04; A61C 15/00; B01L
 2300/042; B01L 3/502; B01L 3/5029;
 G01N 2001/028; A61M 2025/0246;
 A61M 25/0009; A61M 25/007; A61M
 25/02; A61M 25/09033; A61M 5/3286;
 A61M 5/343; A61M 35/00; A61M
 35/003; A61M 35/006; A61K 13/02;
 A45D 24/02; A45D 24/04; A45D 24/36
 See application file for complete search history.

(56) **References Cited**

U.S. PATENT DOCUMENTS

6,440,136 B1 * 8/2002 Gambale A61B 17/8605
 411/402
 D545,431 S * 6/2007 Khademhosseini D24/119

D631,957 S 2/2011 Perez et al.
 D694,951 S 12/2013 Solomon, Jr. et al.
 D701,600 S * 3/2014 Kauffman D24/119
 D739,013 S 9/2015 Landry
 D772,398 S 11/2016 Triva
 D777,443 S * 1/2017 Xu D4/101
 D866,763 S * 11/2019 Khademhosseini D24/151
 10,888,309 B2 * 1/2021 Fischvogt A61B 17/0057
 2019/0209390 A1 * 7/2019 Silvaroli A61F 13/38

OTHER PUBLICATIONS

Ears360 Post, first available Sep. 27, 2019, facebook.com, [online],
 [site visited Aug. 12, 2021], Available from internet URL: <https://www.facebook.com/Ears360> (Year: 2019).*

Ears 360 | Single, ears-360.com, [online], [site visited Aug. 12,
 2021], Available from internet URL: <https://ears-360.com/en/product-2/ears-360-single/> (Year: 2021).*

Internet Archive of <http://web.archive.org/web/20180316221347/https://www.magidglove.com/QTip-Cotton-Swabs-500-pack-623181.aspx> Mar. 16, 2018 (13 pages).

Internet Archive of <http://web.archive.org/web/20160127131451/http://www.amazon.com/Pack-Corn-Cob-Holders-Skewers/dp/B00CVZ1AQK> Jan. 27, 2016 (7 pages).

* cited by examiner

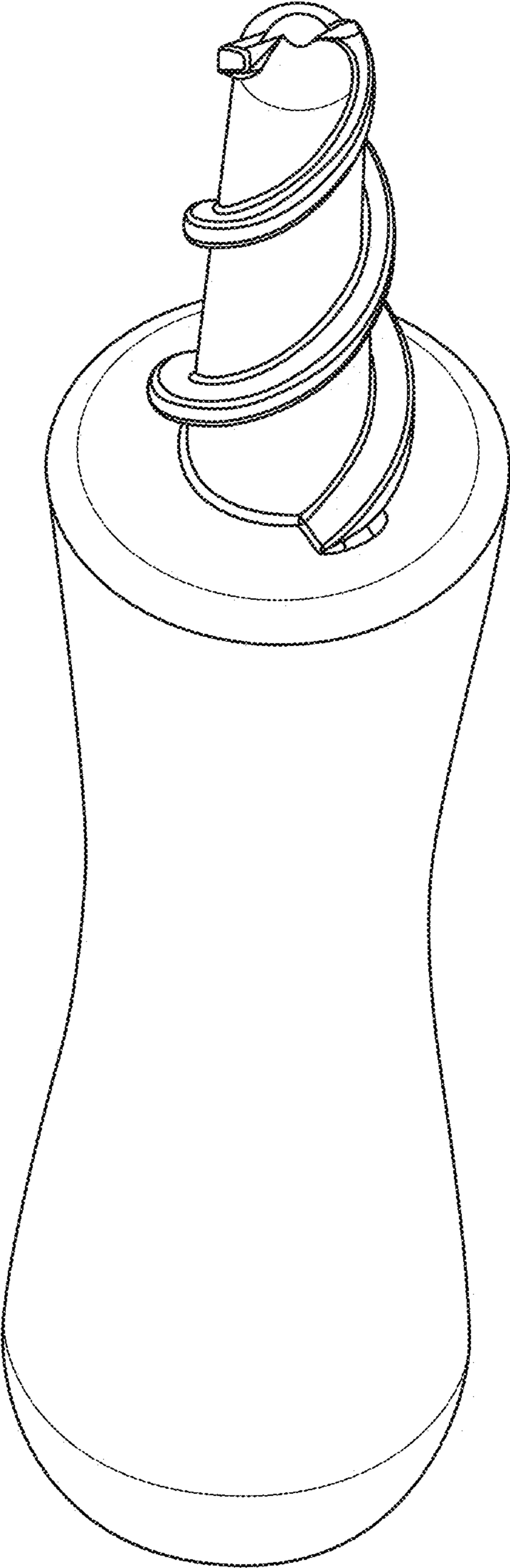

FIG. 1

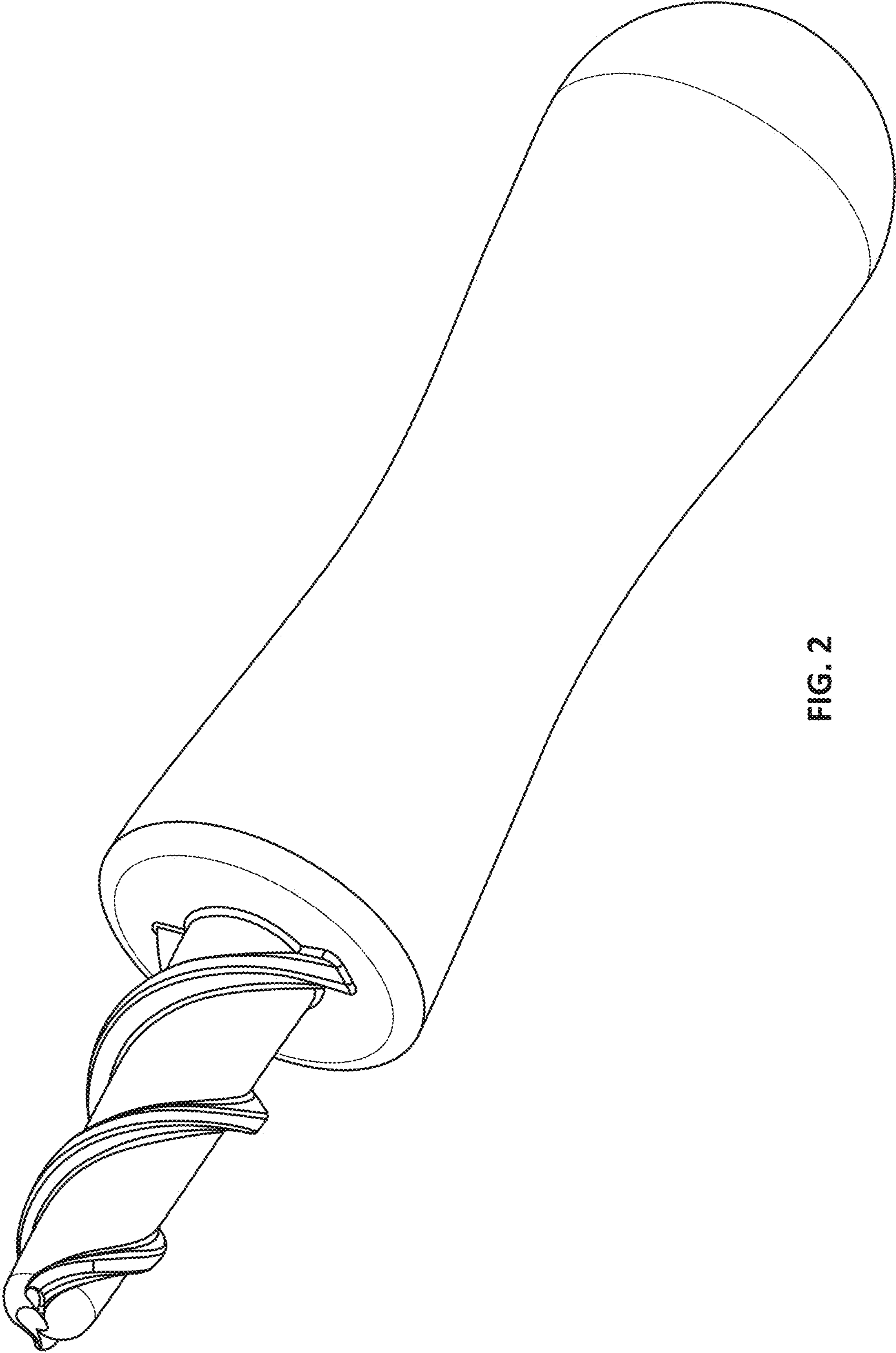

FIG. 2

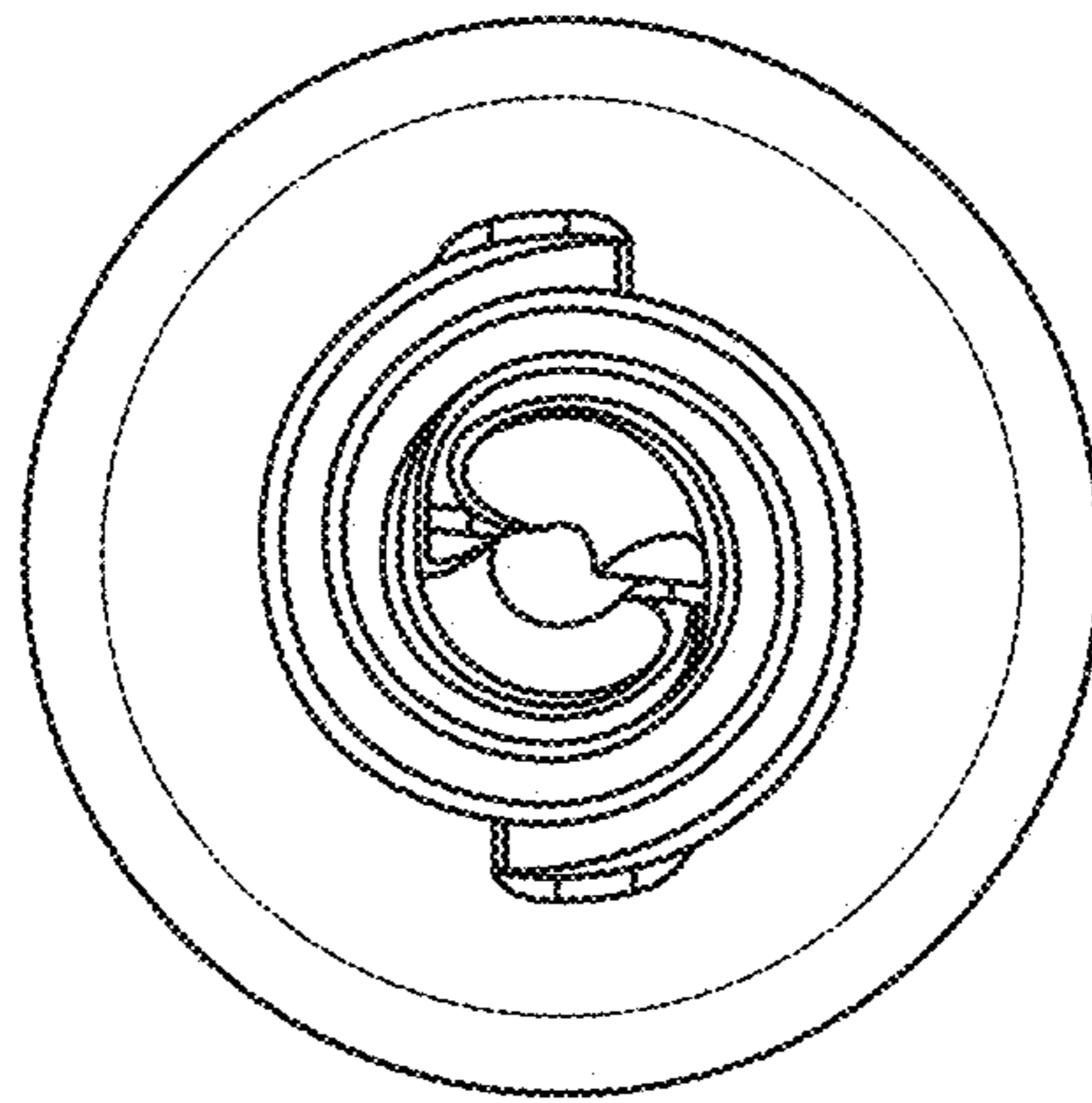

FIG. 3

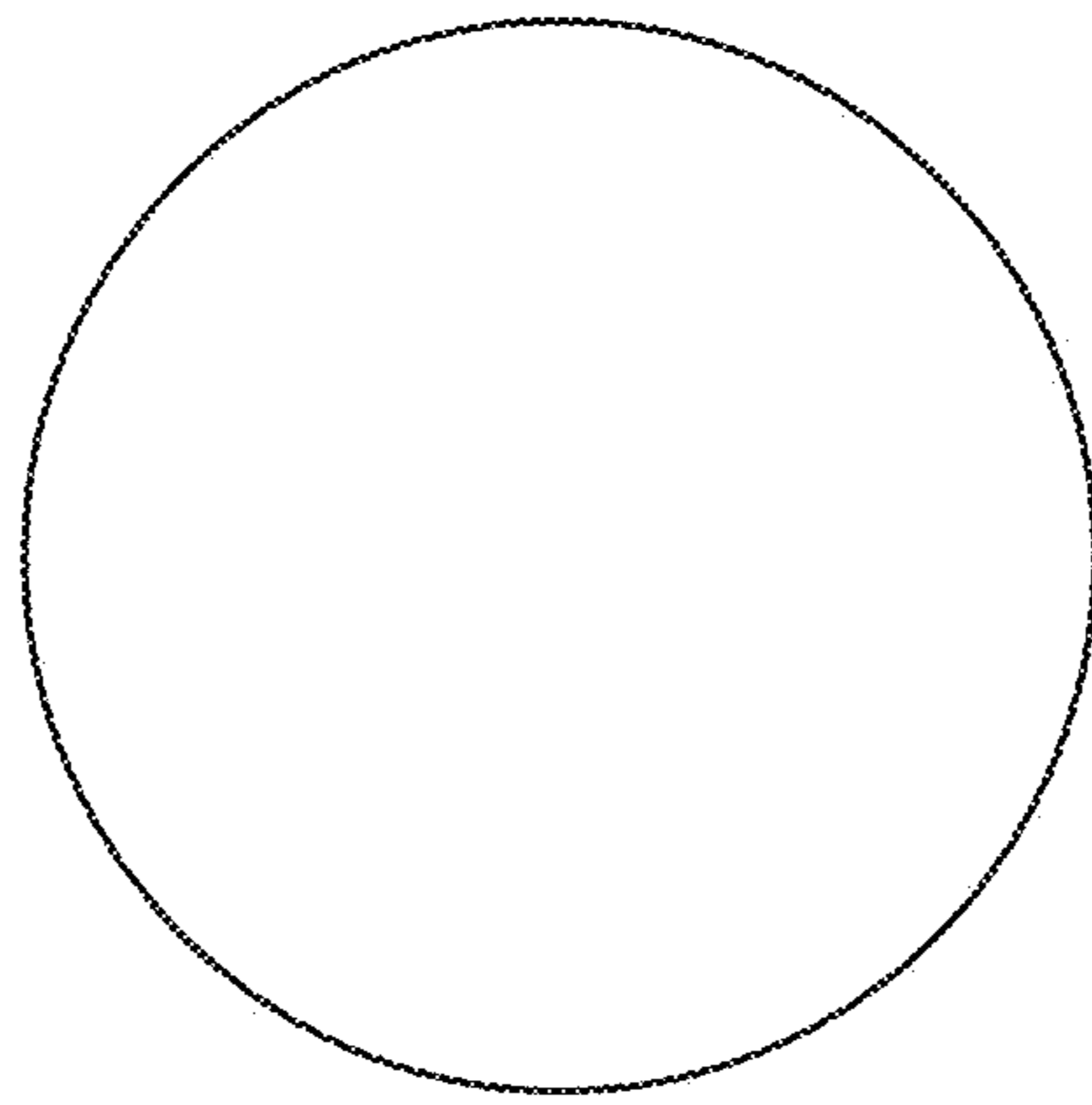

FIG. 4

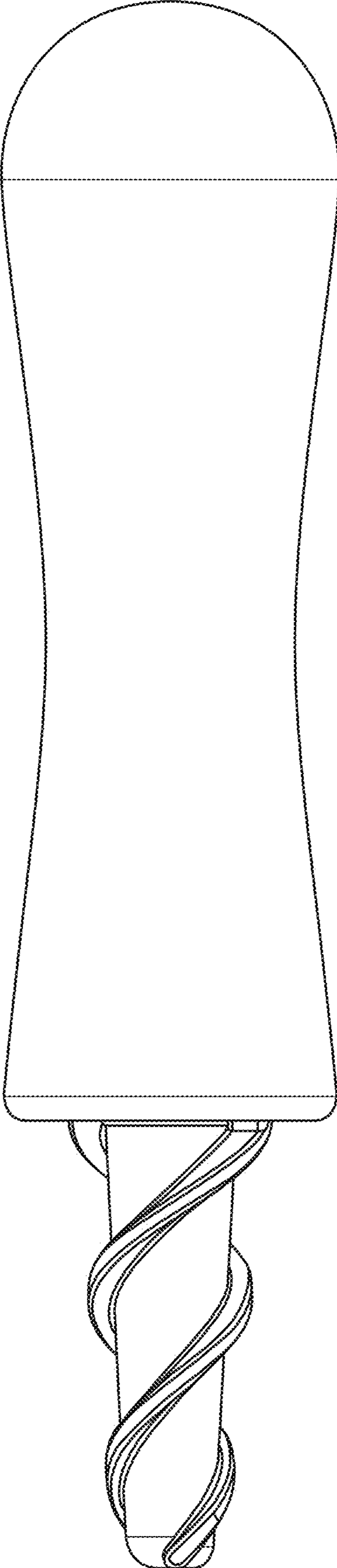

FIG. 5

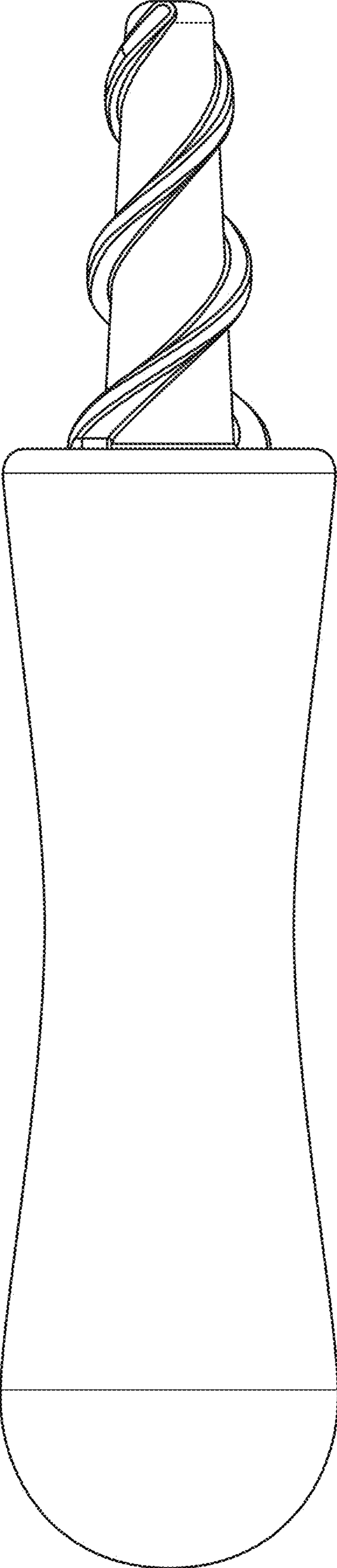

FIG. 6