



US00D957574S

(12) **United States Design Patent**
Park

(10) **Patent No.:** **US D957,574 S**

(45) **Date of Patent:** **** Jul. 12, 2022**

(54) **HANDSHOWER**

(71) Applicant: **DELTA FAUCET COMPANY,**
Indianapolis, IN (US)

(72) Inventor: **Maris Park,** McCordsville, IN (US)

(73) Assignee: **DELTA FAUCET COMPANY,**
Indianapolis, IN (US)

(**) Term: **15 Years**

(21) Appl. No.: **29/737,688**

(22) Filed: **Jun. 11, 2020**

(51) **LOC (13) Cl.** **23-01**

(52) **U.S. Cl.**
USPC **D23/226**

(58) **Field of Classification Search**
USPC D23/213, 214, 223, 226, 228, 229, 230,
D23/238, 239, 240, 241, 242, 249, 250,
D23/255, 257
CPC B05B 1/16; B05B 1/1618; B05B 1/18;
B05B 1/185; B05B 15/62; B05B 15/652;
F16K 31/60; F16K 31/607; E03C 1/02;
E03C 1/04; E03C 1/0401; E03C 1/0402;
E03C 1/0404; E03C 1/0405; E03C
1/0408; E03C 1/06; E03C 1/063; E03C
1/066; E03C 2001/0414; E03C
2001/0415; Y10T 137/9464

See application file for complete search history.

(56) **References Cited**

U.S. PATENT DOCUMENTS

D589,117 S *	3/2009	Bardsley	D23/228
D590,916 S *	4/2009	Schoenherr	D23/223
D590,917 S *	4/2009	Schoenherr	D23/223
D655,386 S *	3/2012	Schoenherr	D23/223
D655,387 S *	3/2012	Schoenherr	D23/223
D655,390 S *	3/2012	Schoenherr	D23/223
D655,783 S *	3/2012	Schoenherr	D23/223
D669,156 S *	10/2012	Schoenherr	D23/223

D674,038 S *	1/2013	Mendoza	D23/213
D713,004 S *	9/2014	Schoenherr	D23/223
D713,498 S *	9/2014	Schoenherr	D23/223
D724,180 S *	3/2015	Lin	D23/213
9,795,974 B2 *	10/2017	Zhou	B05B 1/169
10,132,423 B1 *	11/2018	Lan	B05B 1/3026
10,173,235 B2 *	1/2019	Lin	B05B 1/1627
10,195,654 B2 *	2/2019	Honda	B23K 26/21
D846,696 S *	4/2019	Cocks	D23/223
10,322,420 B2 *	6/2019	Lin	B05B 1/1636
D858,700 S *	9/2019	Stoler	D23/223
D869,608 S *	12/2019	Seum	D23/223

(Continued)

OTHER PUBLICATIONS

HotelSpa 1538 Hand Shower, May 24, 2017, Amazon, site visited Aug. 2, 2021: <https://www.amazon.com/dp/B0719RG317/> (Year: 2017).*

(Continued)

Primary Examiner — Jack Reickel
Assistant Examiner — Bobby W Jones, II
(74) *Attorney, Agent, or Firm* — Nirav D. Parikh; Edgar A. Zarins

(57) **CLAIM**

The ornamental design for a handshower, as shown and described.

DESCRIPTION

FIG. 1 is a front perspective view of a handshower showing my new design;
FIG. 2 is a rear perspective view thereof;
FIG. 3 is a front elevational view thereof;
FIG. 4 is a left side view thereof;
FIG. 5 is a rear view thereof;
FIG. 6 is a right side view thereof;
FIG. 7 is a top plan view thereof; and,
FIG. 8 is a bottom view thereof.

1 Claim, 4 Drawing Sheets

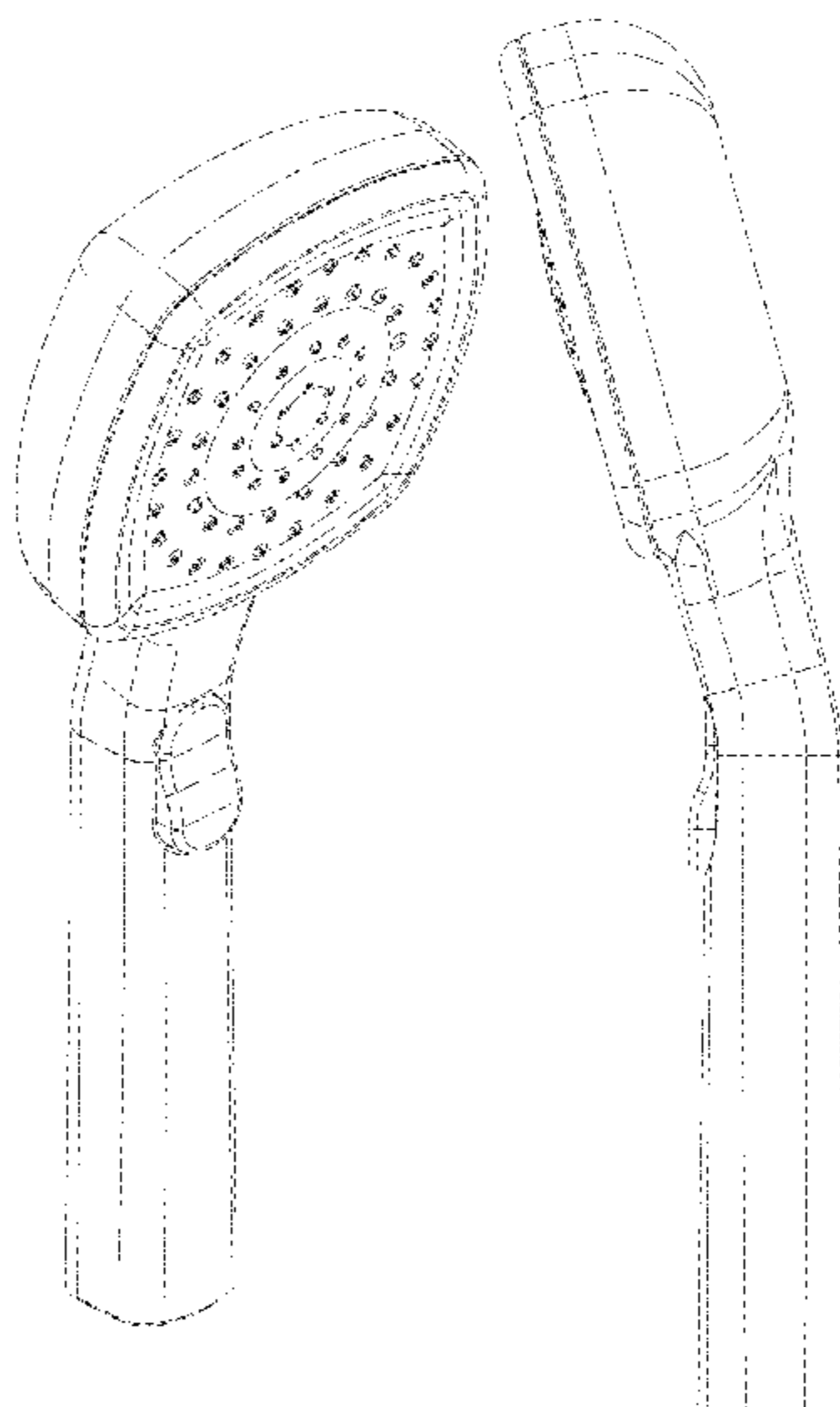

(56)

References Cited

U.S. PATENT DOCUMENTS

D879,247 S * 3/2020 Staler D23/223
D925,699 S * 7/2021 Komatsu D23/223
2013/0254985 A1* 10/2013 Zhou B05B 1/1654
4/615
2016/0310972 A1* 10/2016 Lin B05B 1/1636
2019/0143346 A1* 5/2019 Lin B05B 1/18
239/562

OTHER PUBLICATIONS

Hansgrohe Croma 04723400, Dec. 29, 2017, Amazon, site visited
Aug. 2, 2021: <https://www.amazon.com/dp/B075QV873P/> (Year:
2017).*

* cited by examiner

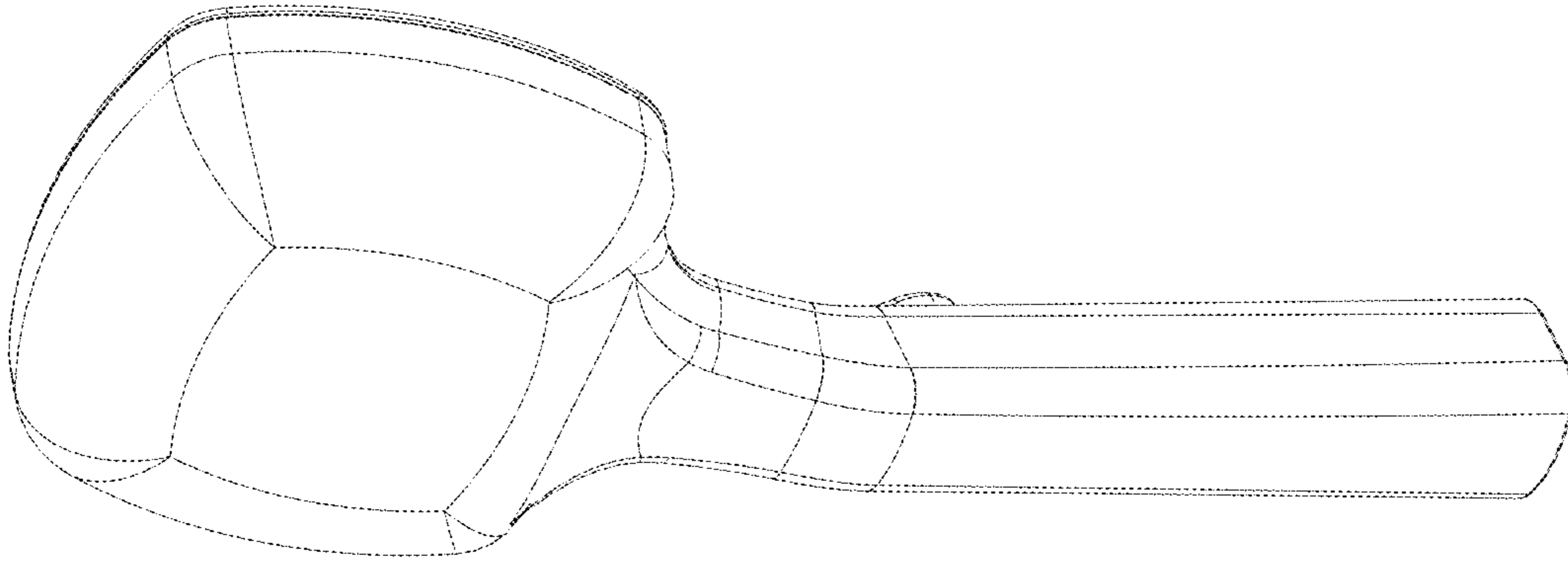

FIG-2

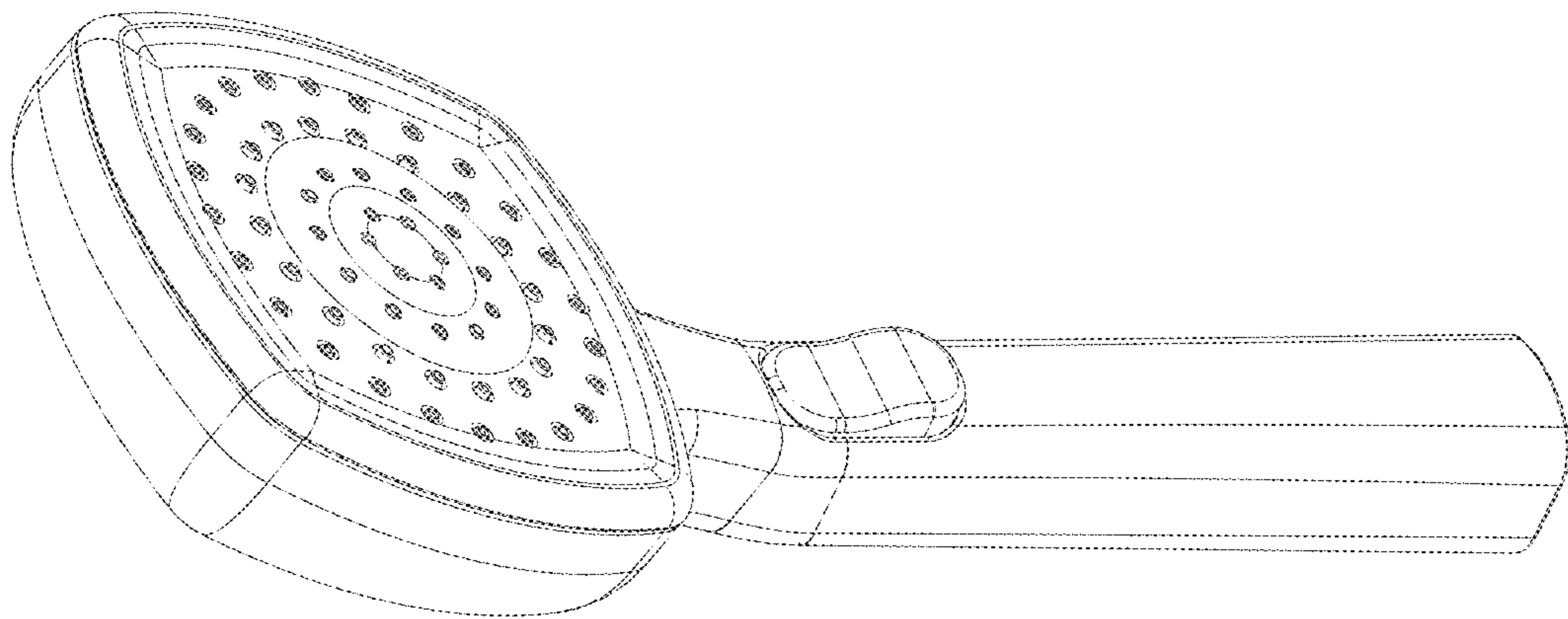

FIG-1

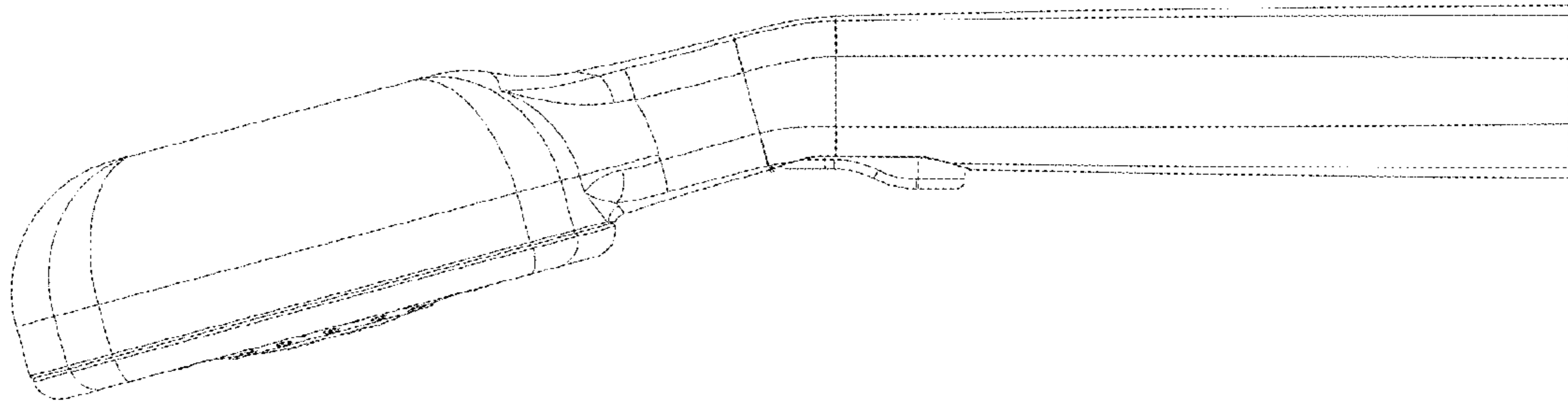

FIG-4

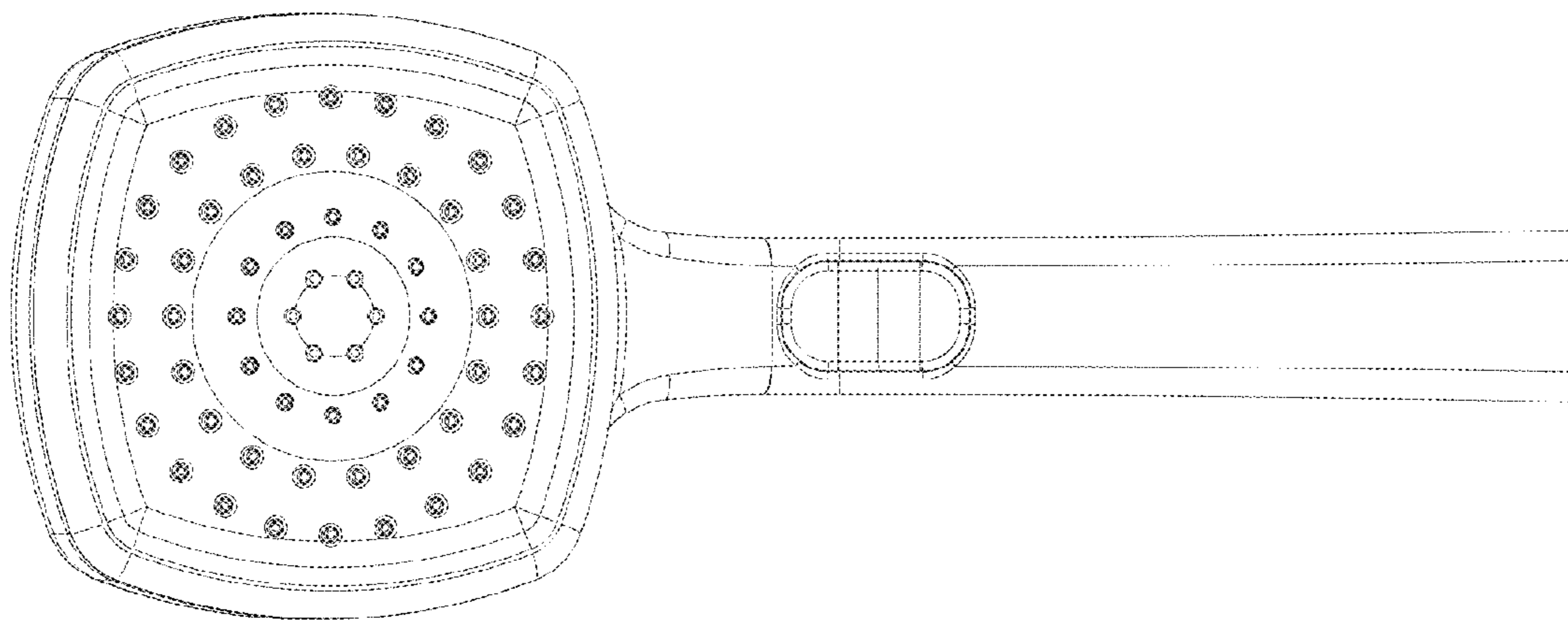

FIG-3

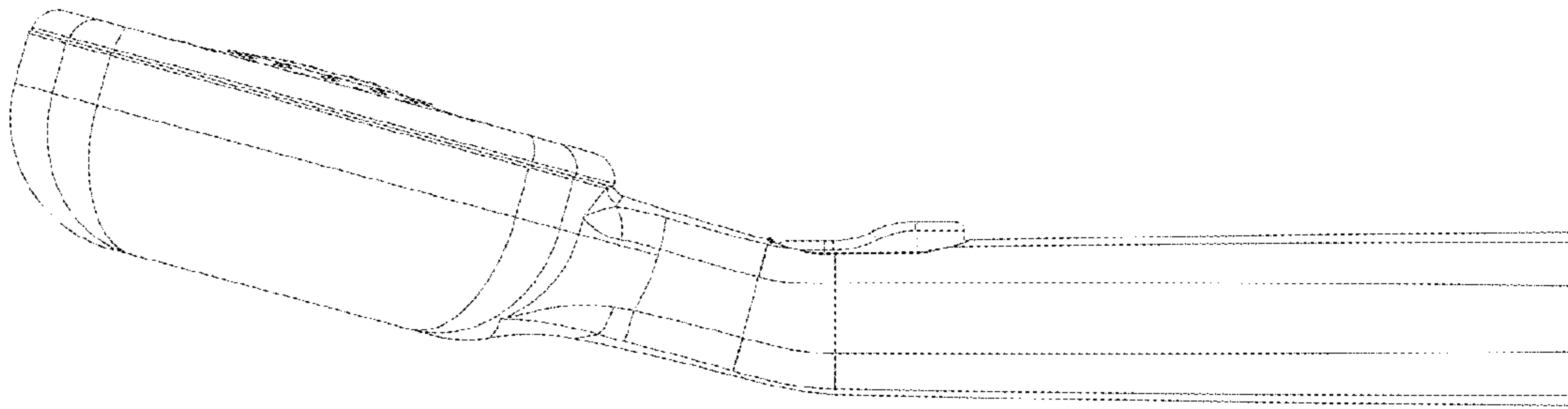

FIG-6

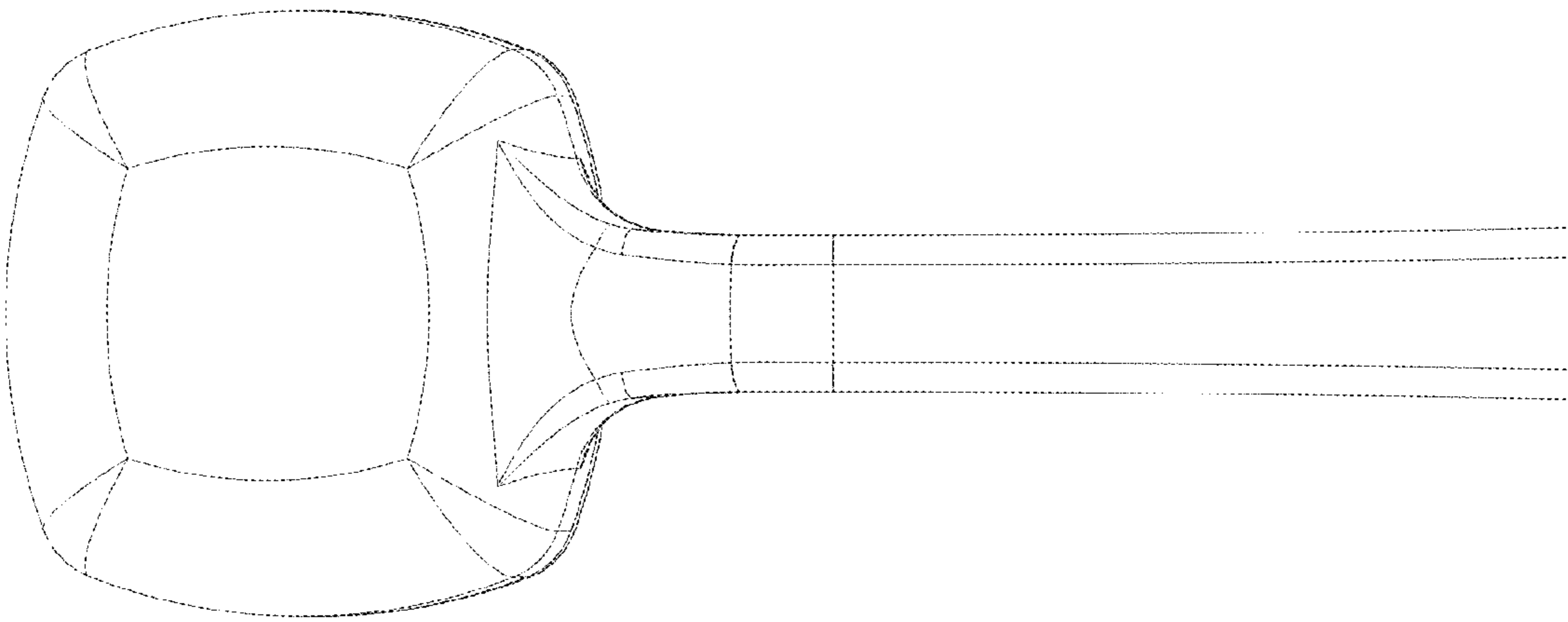

FIG-5

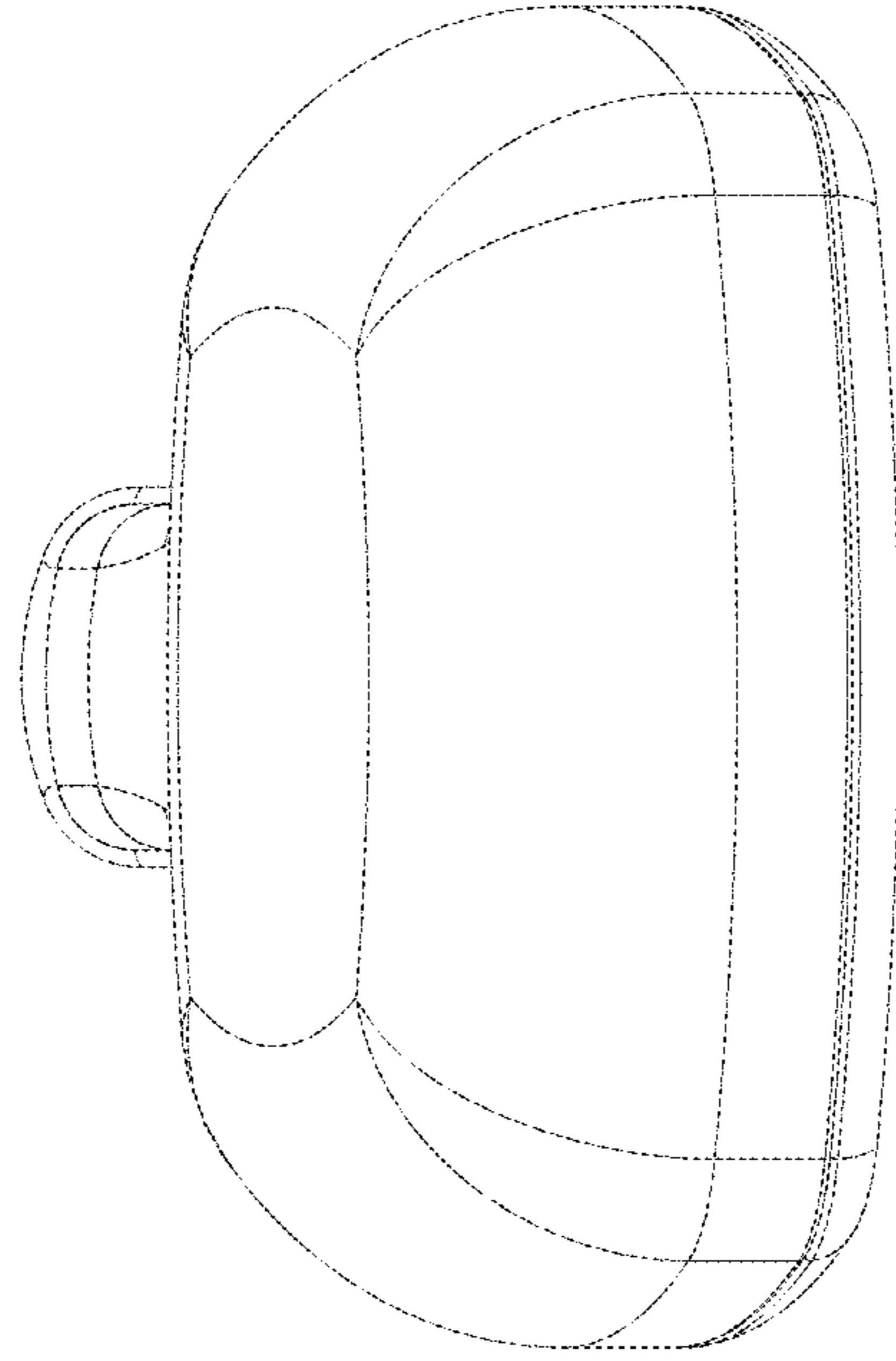

FIG-8

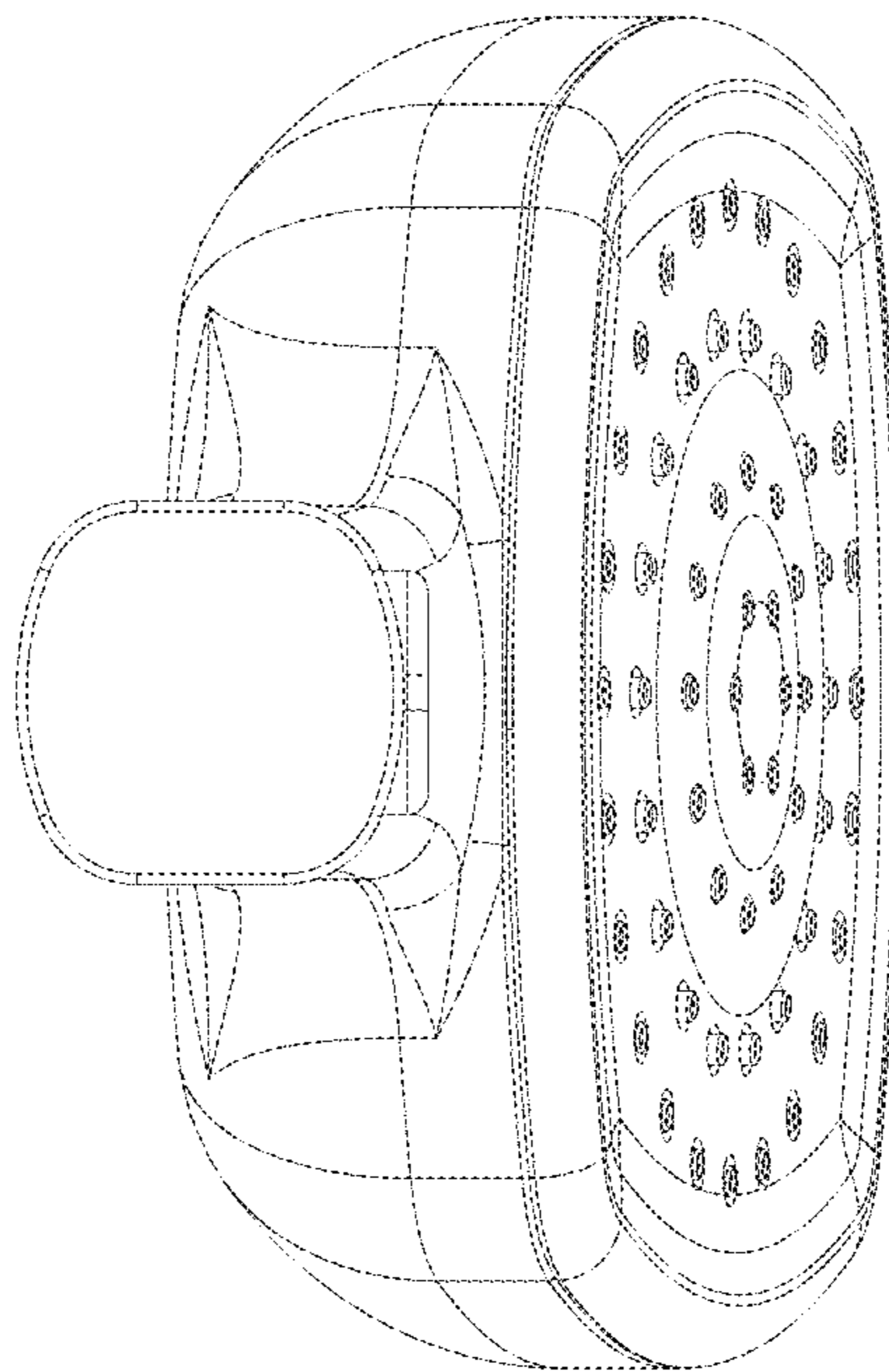

FIG-7