



US00D957571S

(12) **United States Design Patent**
de Swarte et al.

(10) **Patent No.:** **US D957,571 S**
(45) **Date of Patent:** **** Jul. 12, 2022**

(54) **HANDSHOWER**

D416,979 S * 11/1999 Bosio D23/223
D433,098 S * 10/2000 Cutler D23/223
D446,842 S * 8/2001 Green D23/255

(71) Applicant: **Kohler Co.**, Kohler, WI (US)

(Continued)

(72) Inventors: **Gregory de Swarte**, Sheboygan, WI (US); **Margaret C. Mazz**, Sheboygan, WI (US); **Yutong Wu**, Sheboygan, WI (US)

OTHER PUBLICATIONS

Kohler Statement Iconic K-26286-G, Feb. 14, 2022, Kohler, site visited Feb. 14, 2022: <https://www.us.kohler.com/us/statement-single-function-iconic-1.75-gpm-handshower/productDetail/handshowers/1931332.htm> (Year: 2022).*

(73) Assignee: **KOHLER CO.**, Kohler, WI (US)

(Continued)

(**) Term: **15 Years**

Primary Examiner — Jack Reickel

(21) Appl. No.: **29/755,098**

Assistant Examiner — Bobby W Jones, II

(22) Filed: **Oct. 16, 2020**

(74) *Attorney, Agent, or Firm* — Foley & Lardner LLP

(51) **LOC (13) Cl.** **23-01**

(52) **U.S. Cl.**
USPC **D23/223**

(57) **CLAIM**

We claim the ornamental design for a handshower, as shown and described.

(58) **Field of Classification Search**
USPC D23/213, 223, 224, 226, 228, 229, 238, 240, 241, 242, 250
CPC B05B 1/16; B05B 1/1618; B05B 1/18; E03C 1/0401; E03C 1/0404; E03C 1/0405; E03C 1/0408; E03C 1/041; E03C 1/066; E03C 2001/0415
See application file for complete search history.

DESCRIPTION

FIG. 1 is a perspective view of the claimed design; FIG. 2 is a top view of the claimed design shown in FIG. 1; FIG. 3 is a bottom view of the claimed design shown in FIG. 1; FIG. 4 is a side view of the claimed design shown in FIG. 1; FIG. 5 is another side view of the claimed design shown in FIG. 1; FIG. 6 is a front view of the claimed design shown in FIG. 1; and, FIG. 7 is a rear view of the claimed design shown in FIG. 1.

(56) **References Cited**

U.S. PATENT DOCUMENTS

D289,545 S * 4/1987 Koch D23/223
D320,643 S * 10/1991 Stansbury, Jr. D23/226
5,145,114 A * 9/1992 Monch B05B 1/1618
239/447
D337,810 S 7/1993 Bengtson
D352,347 S 11/1994 Dannenberg
5,707,011 A * 1/1998 Bosio B05B 15/65
239/447
D392,719 S * 3/1998 Guo D23/223
D404,116 S * 1/1999 Bosio D23/223
D404,117 S * 1/1999 Bosio D23/223

The even-dashed broken line showing of a handshower is include for the purpose of illustrating portions of the article and forms no part of the claimed design. The dash-dot broken line(s) define the bounds of the claimed design and form no part thereof.

1 Claim, 7 Drawing Sheets

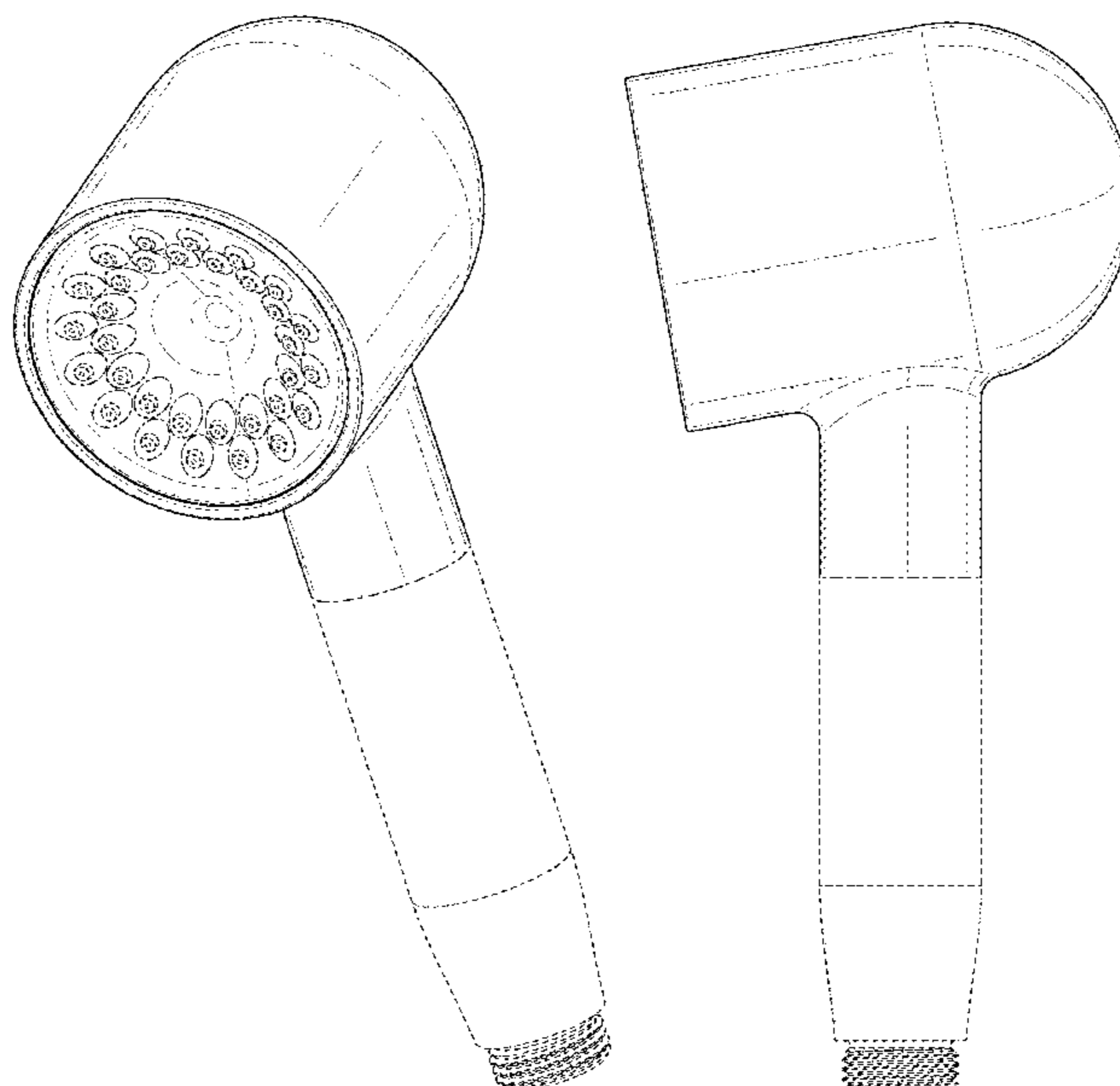

(56)

References Cited

U.S. PATENT DOCUMENTS

6,290,147 B1 * 9/2001 Bertrand B05B 1/1618
239/444
D467,636 S * 12/2002 Boesch D23/223
D476,066 S * 6/2003 Genslak D23/255
D519,604 S * 4/2006 Swain D23/209
D555,765 S * 11/2007 Bosio D23/223
D565,699 S 4/2008 Berberet
D591,398 S * 4/2009 Lammel D23/238
D629,868 S 12/2010 Barnard
D764,627 S 8/2016 Banham
D788,265 S * 5/2017 Ho D23/226
D855,760 S * 8/2019 Lee D23/223
D913,421 S * 3/2021 Yang D23/223
D930,116 S * 9/2021 Sanghun D23/223
2007/0018019 A1 * 1/2007 Nobili B05B 12/004
239/548
2010/0084487 A1 * 4/2010 Gautschi B05B 1/18
239/97

2013/0186496 A1 * 7/2013 Hsu E03C 1/04
137/801
2016/0061346 A1 * 3/2016 Sato F16K 35/04
239/562
2017/0183847 A1 * 6/2017 Ho E03C 1/0405

OTHER PUBLICATIONS

Kohler Statement Iconic K-26286-G Specification Sheet, Jan. 17, 2022, Kohler, site visited Feb. 14, 2022: https://www.us.kohler.com/webassets/kpna/catalog/pdf/en/K-26286-G_spec_US-CA_Kohler_en.pdf (Year: 2022).*

KES Kitchen Faucet Pull Down Sprayer, Nov. 29, 2014, Amazon, site visited Feb. 14, 2022: <https://www.amazon.com/dp/B00QBJSZS8/> (Year: 2014).*

Culligan HSH-C135, Jul. 11, 2005, Amazon, site visited Feb. 14, 2022: <https://www.amazon.com/dp/B0006VVN18/> (Year: 2005).*

* cited by examiner

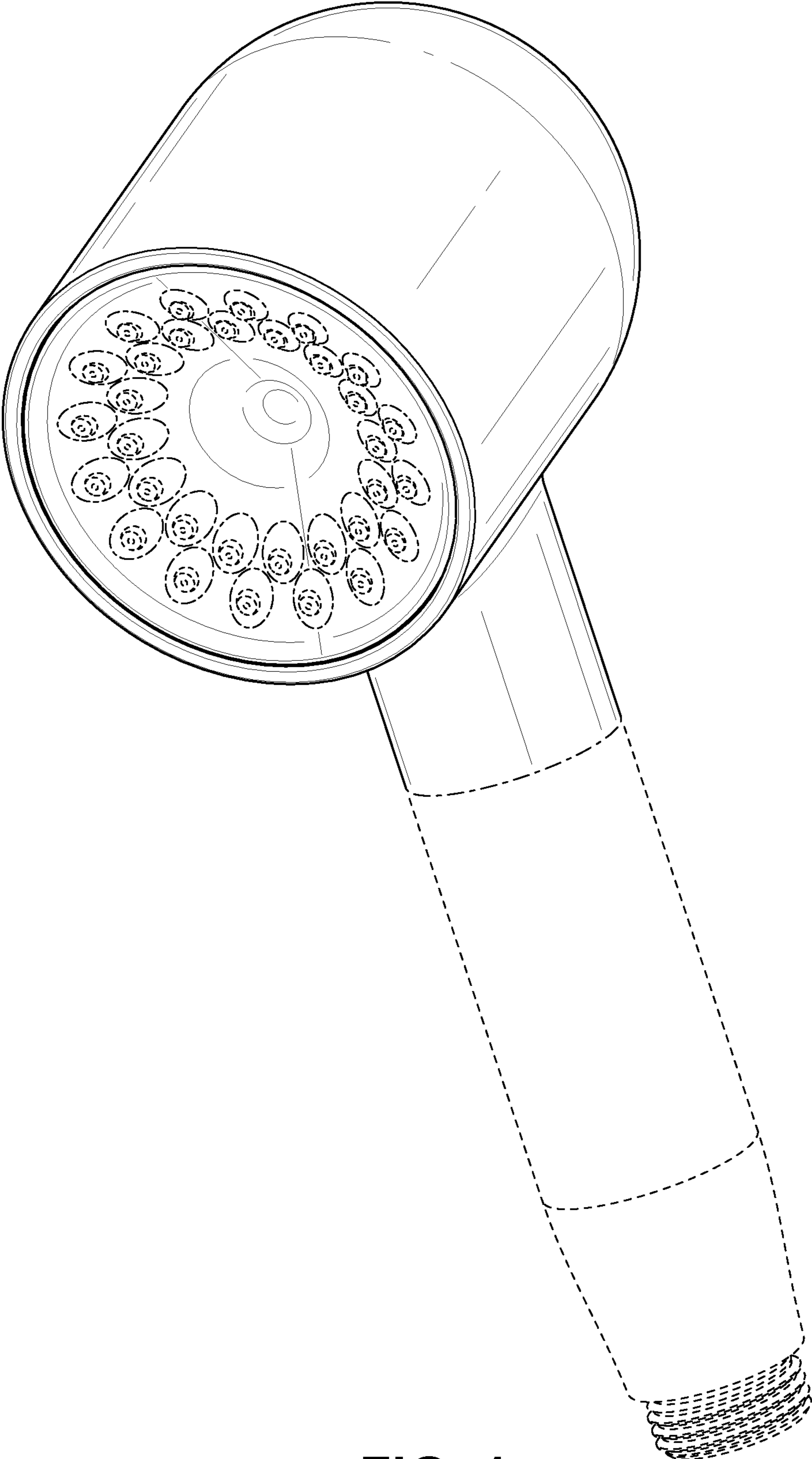

FIG. 1

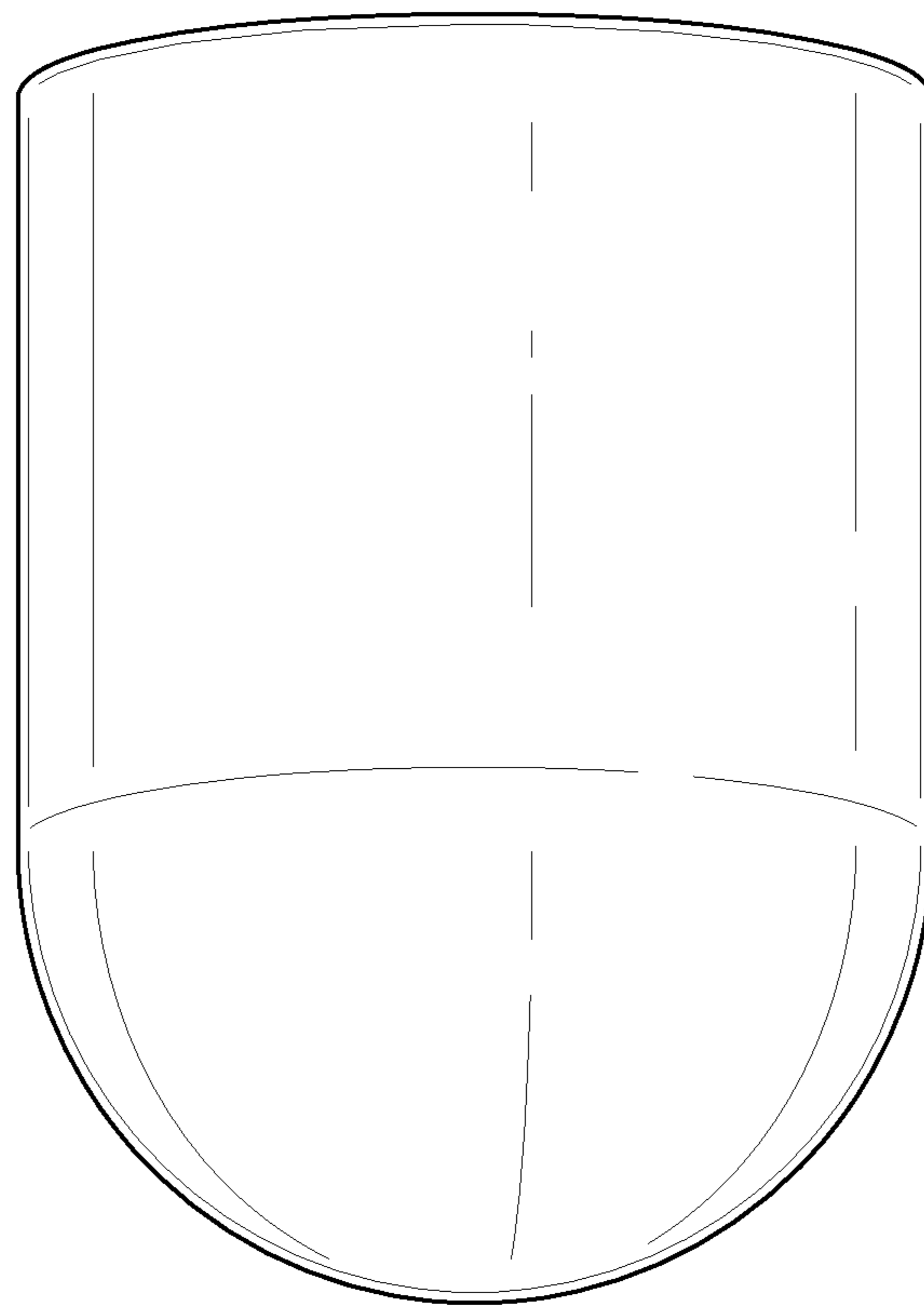

FIG. 2

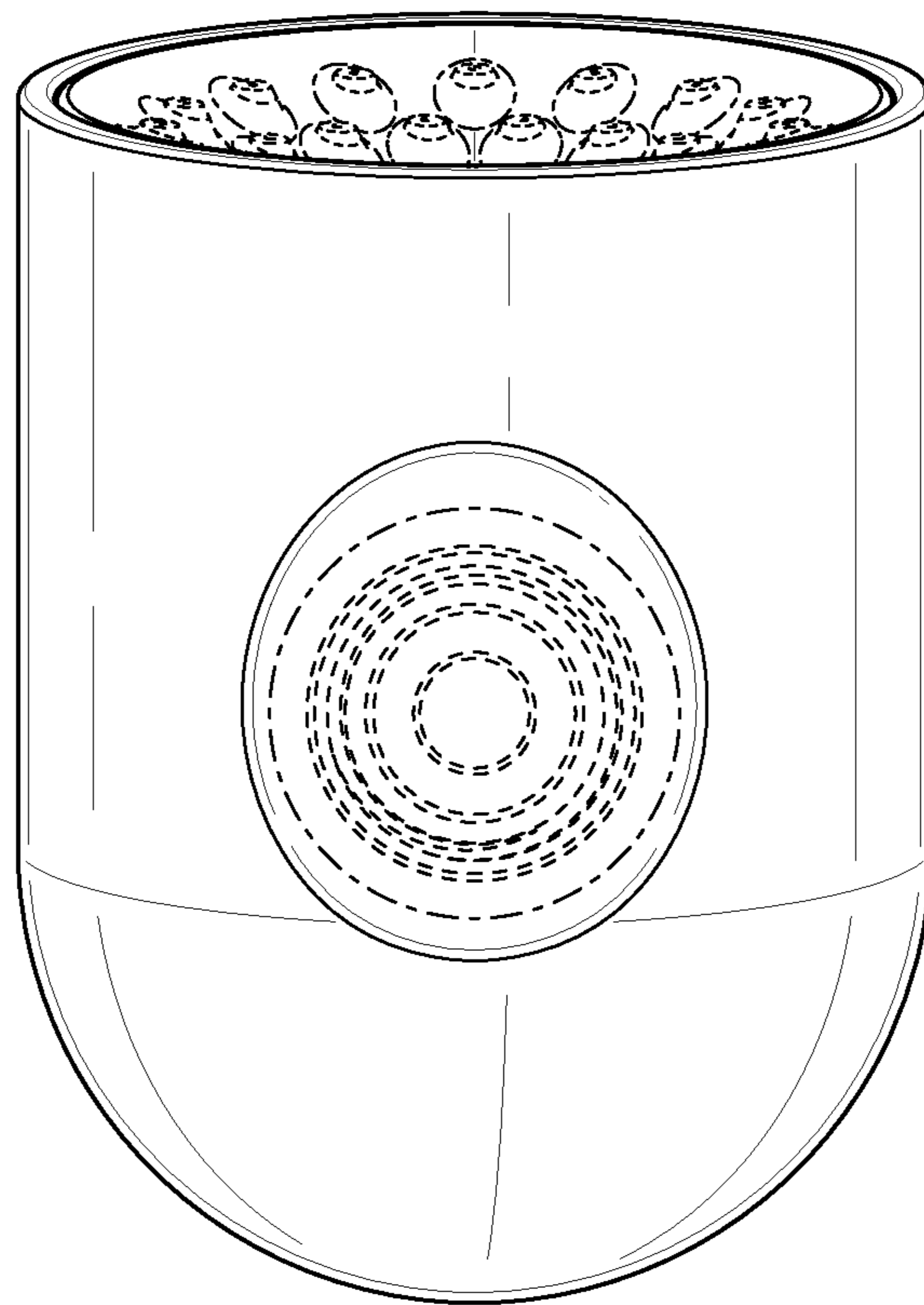

FIG. 3

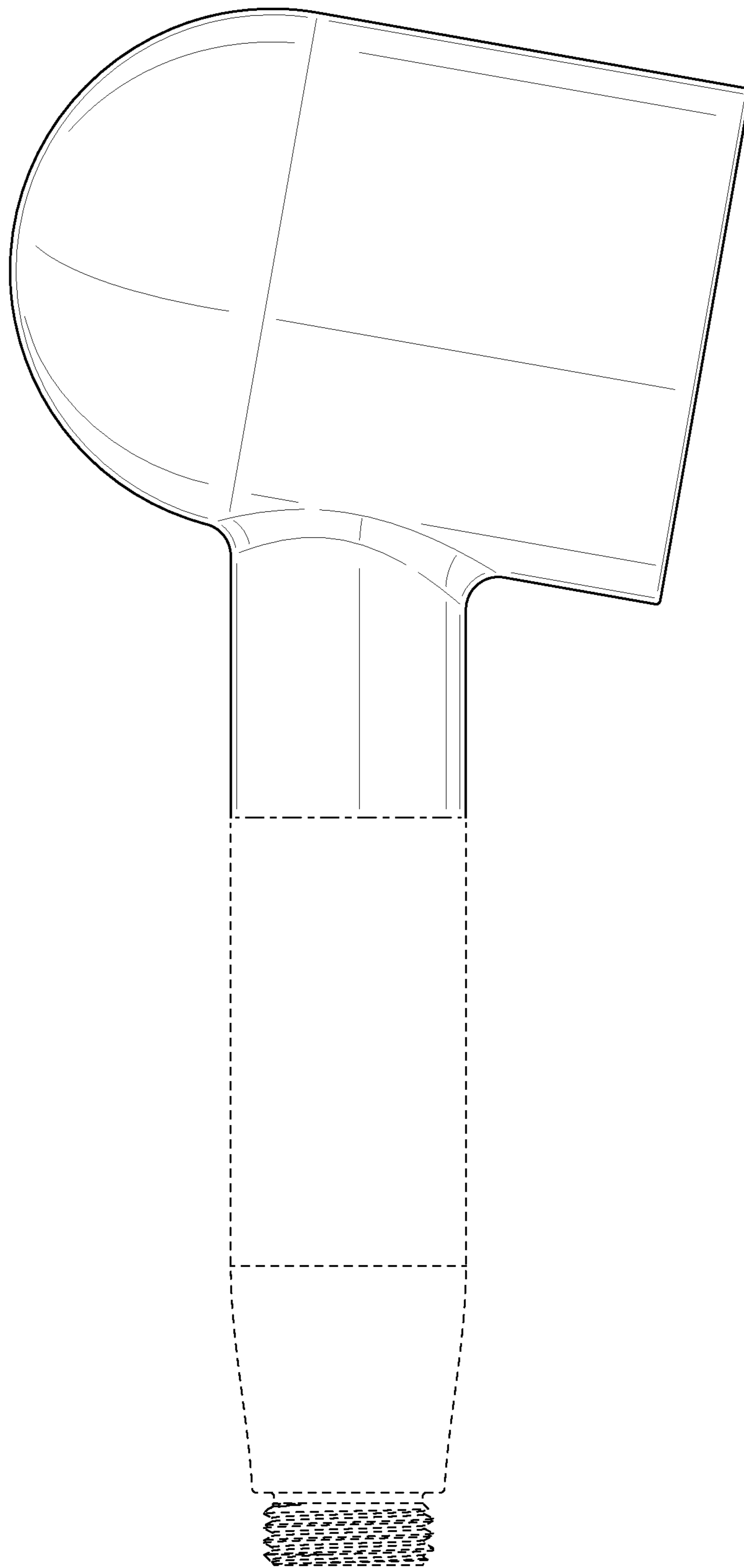

FIG. 4

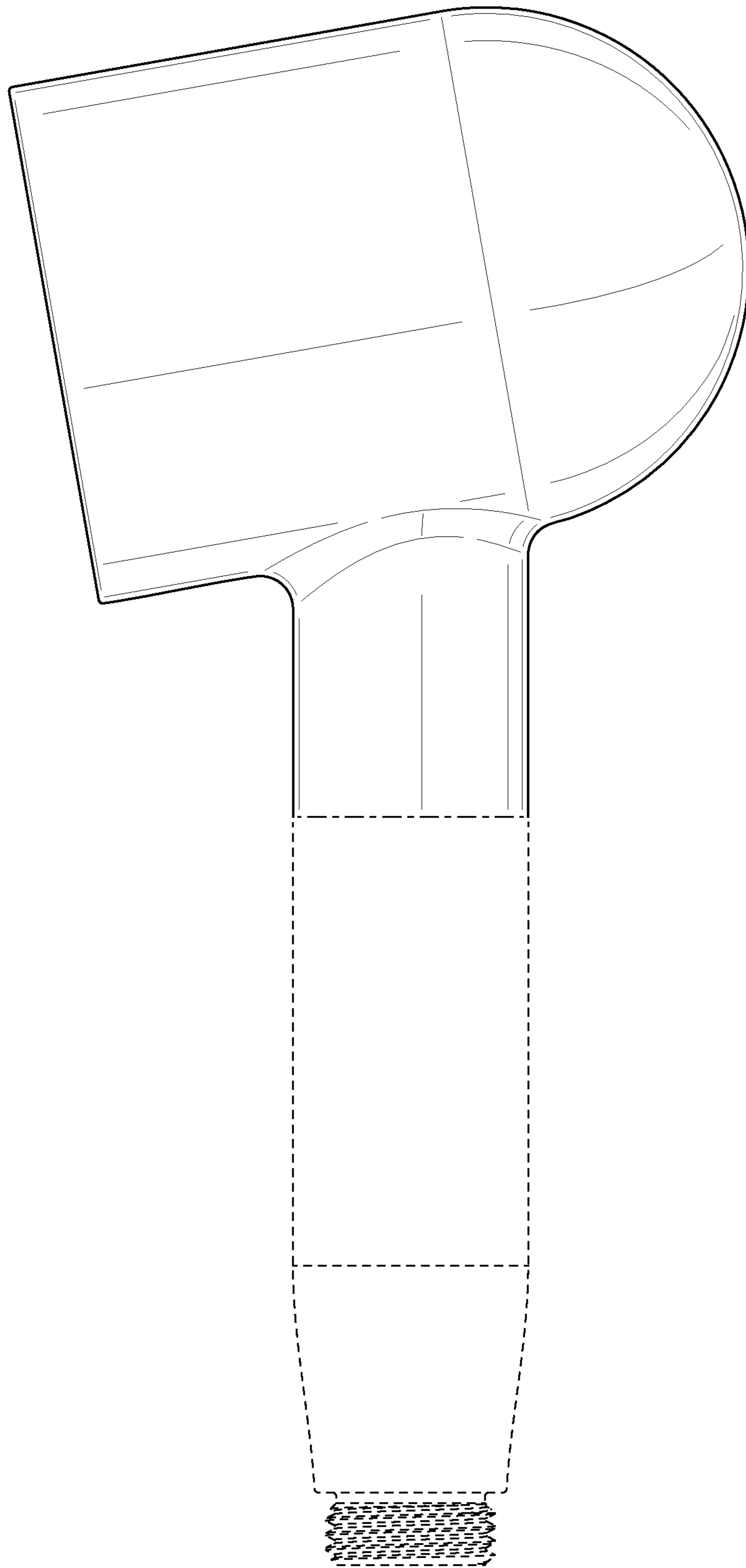

FIG. 5

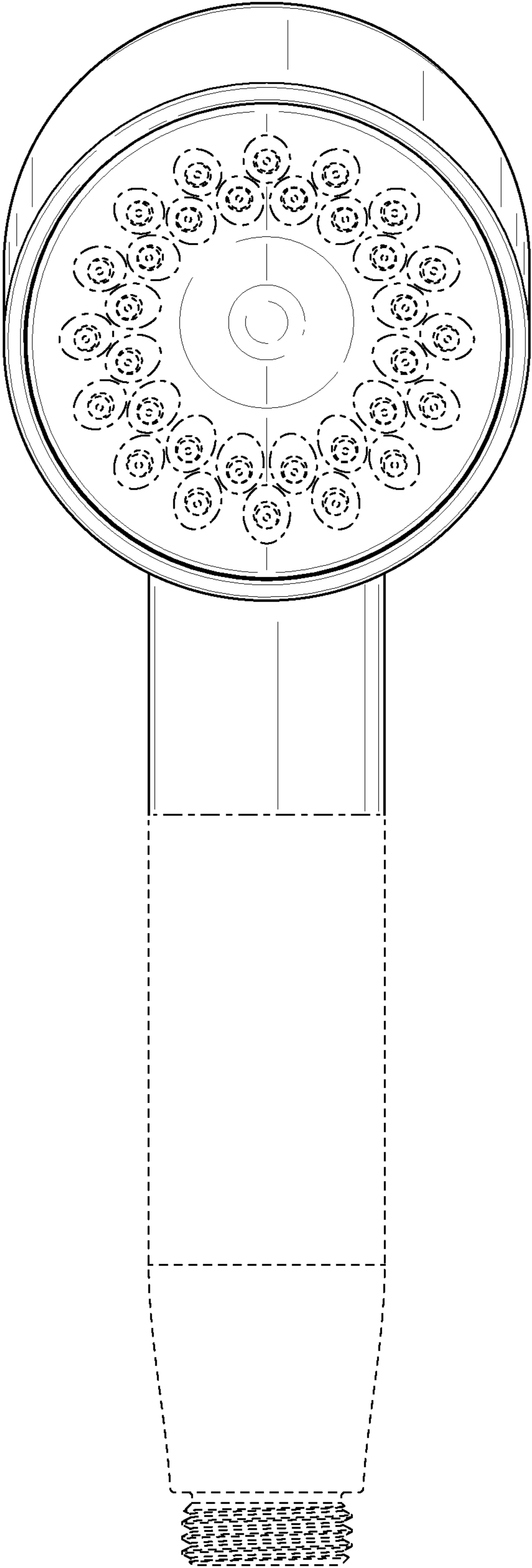

FIG. 6

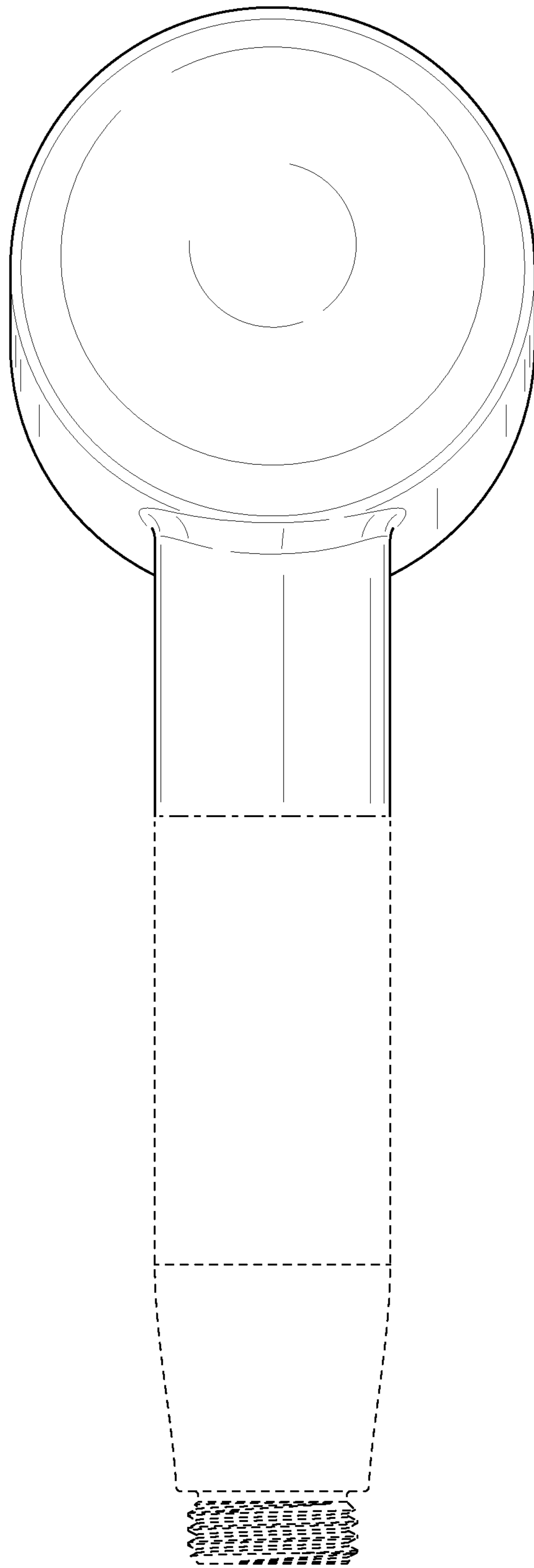

FIG. 7