

US00D957344S

(12) **United States Design Patent**
Qiao

(10) **Patent No.:** **US D957,344 S**
(45) **Date of Patent:** **** Jul. 12, 2022**

(54) **SOCKET**

(71) Applicant: **INTRADIN (HUZHOU) PRECISION TECHNOLOGY CO., LTD.**, Zhejiang (CN)

(72) Inventor: **Xuetao Qiao**, Zhejiang (CN)

(73) Assignee: **INTRADIN (HUZHOU) PRECISION TECHNOLOGY CO., LTD.**, Huzhou (CN)

(**) Term: **15 Years**

(21) Appl. No.: **29/740,724**

(22) Filed: **Jul. 7, 2020**

(51) **LOC (13) Cl.** **13-03**

(52) **U.S. Cl.**
USPC **D13/144**

(58) **Field of Classification Search**
USPC D13/144, 108, 110, 107, 103; D12/114; D14/155, 252; D27/141
CPC H02J 7/0042; H01R 24/58
See application file for complete search history.

(56) **References Cited**

U.S. PATENT DOCUMENTS

4,248,494 A * 2/1981 McDonald H01R 31/02
439/668
5,007,863 A * 4/1991 Xuan H01R 31/02
439/654

D429,689 S * 8/2000 Barragan, Jr. D13/144
D533,838 S * 12/2006 Chen D13/144
D728,471 S * 5/2015 Alesi D13/110
D736,155 S * 8/2015 Alesi D13/110
D781,235 S * 3/2017 Esses D13/144
D864,875 S * 10/2019 Zhang D13/144
D925,819 S * 7/2021 Xu D27/141
2007/0217242 A1 * 9/2007 Dayan H01R 31/065
363/146

* cited by examiner

Primary Examiner — Jennifer O King

(57) **CLAIM**

The ornamental design for a socket, as shown and described.

DESCRIPTION

FIG. 1 is a perspective view of a socket showing my new design;
FIG. 2 is another perspective view thereof;
FIG. 3 is a front elevation view thereof;
FIG. 4 is a back elevation view thereof;
FIG. 5 is a left side view thereof;
FIG. 6 is a right side view thereof;
FIG. 7 is a top plan view thereof; and,
FIG. 8 is a bottom plan view thereof.

1 Claim, 8 Drawing Sheets

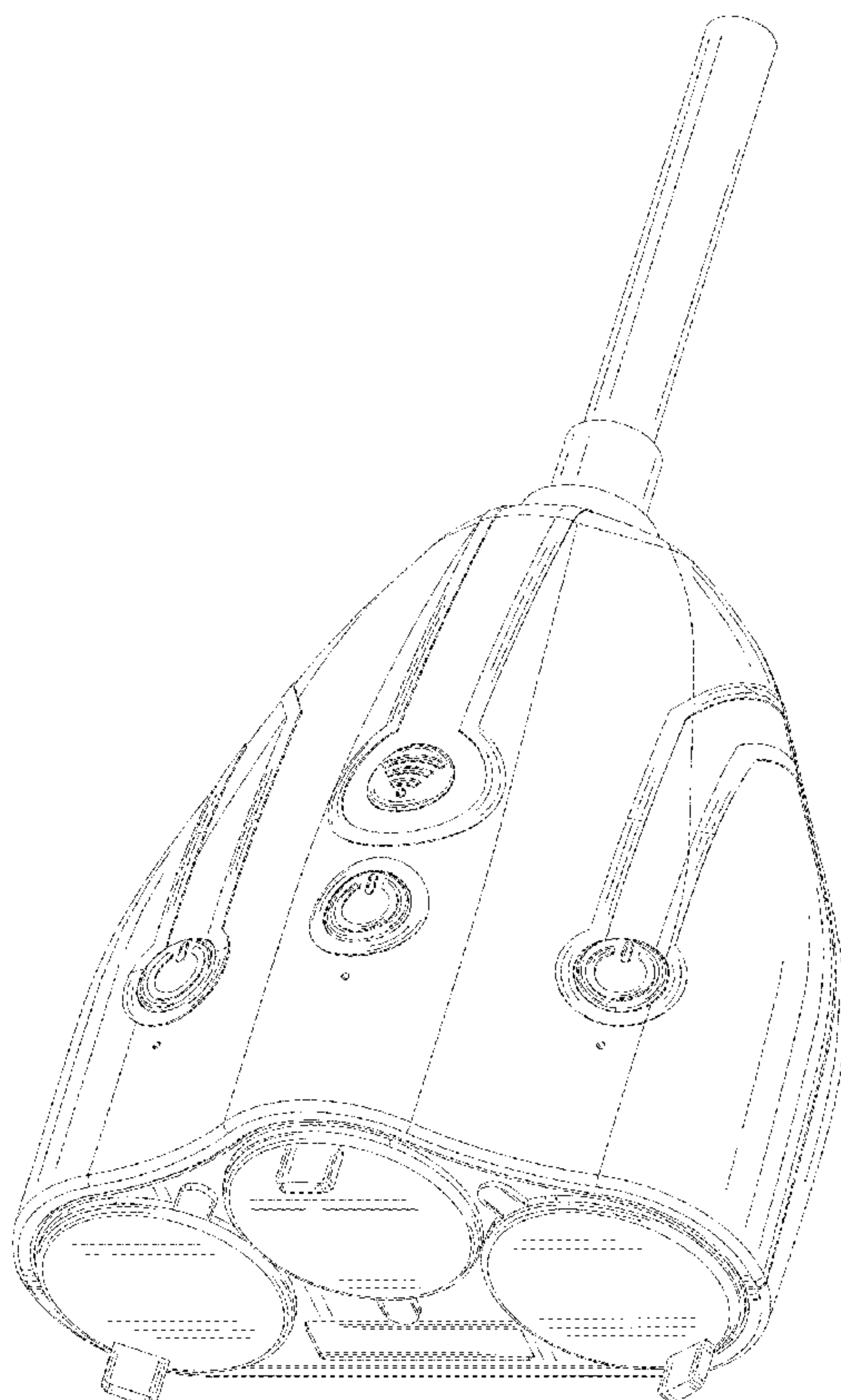

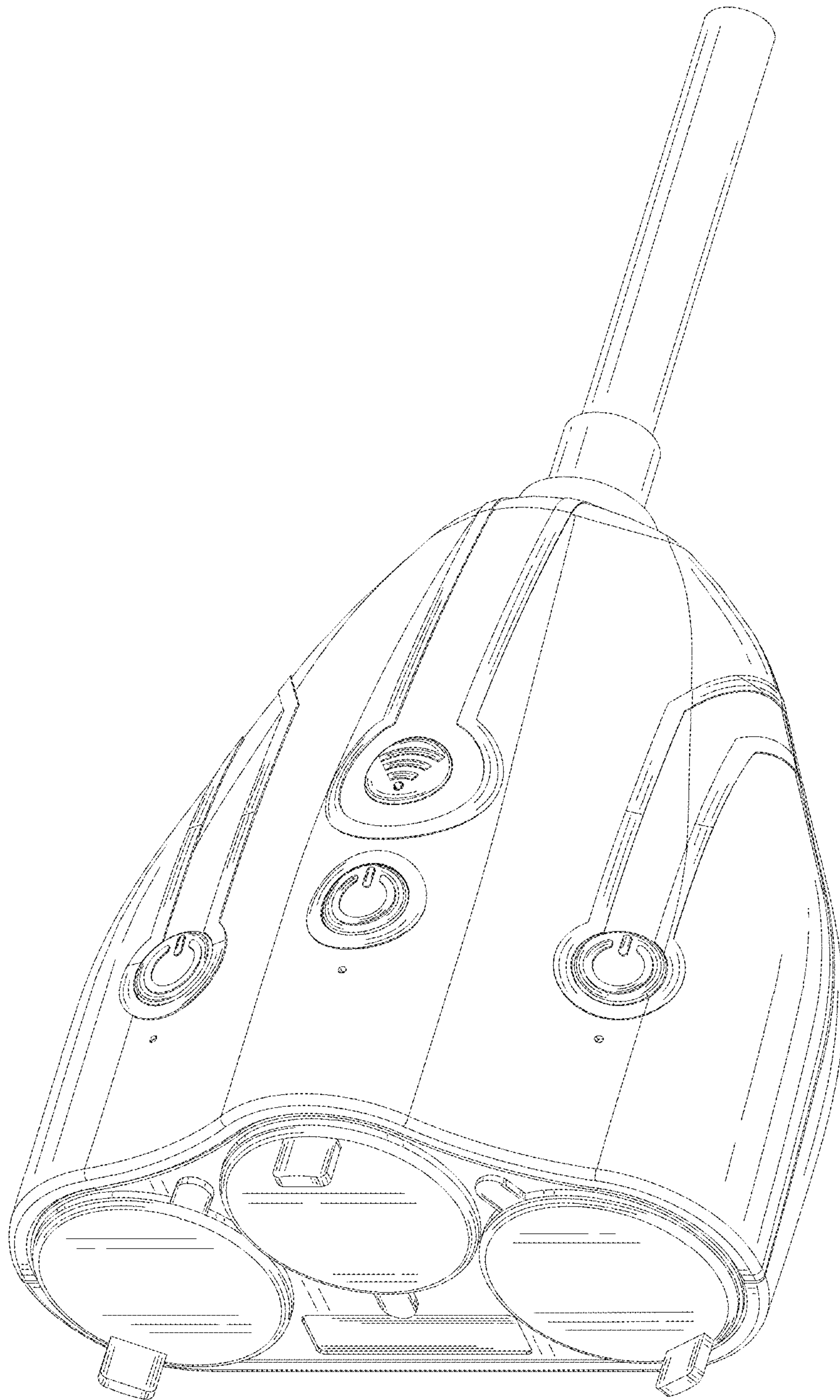

FIG. 1

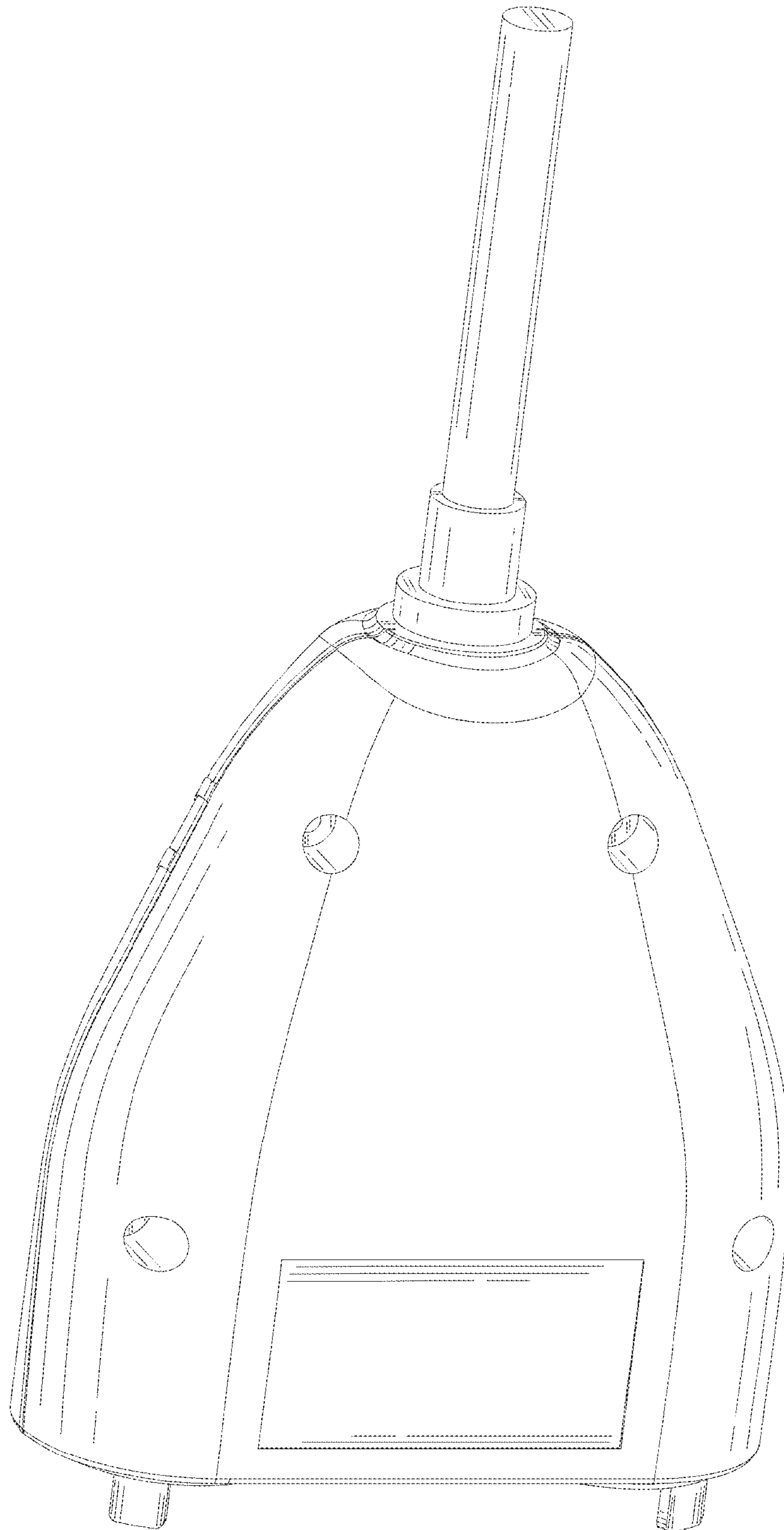

FIG. 2

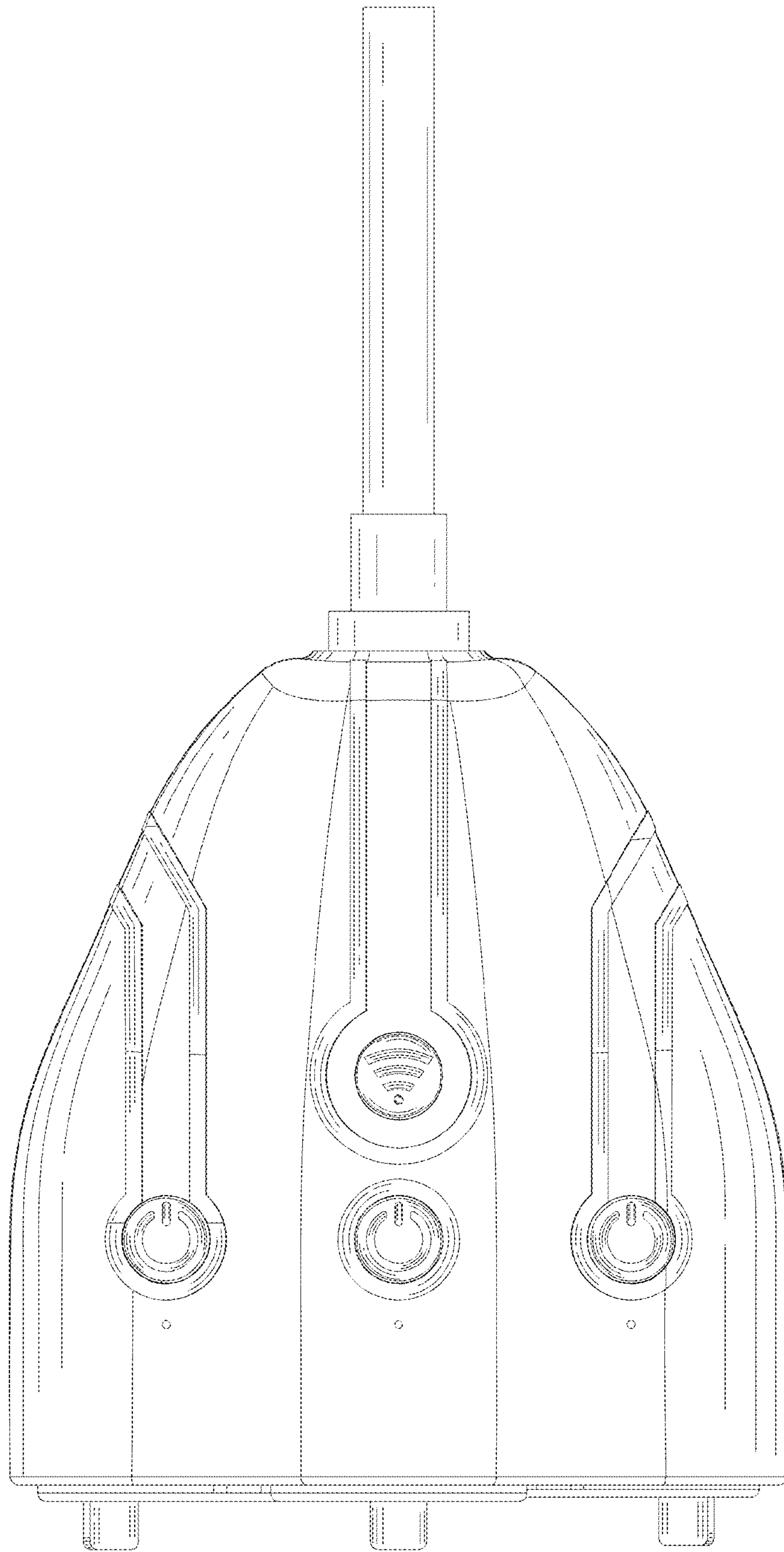

FIG. 3

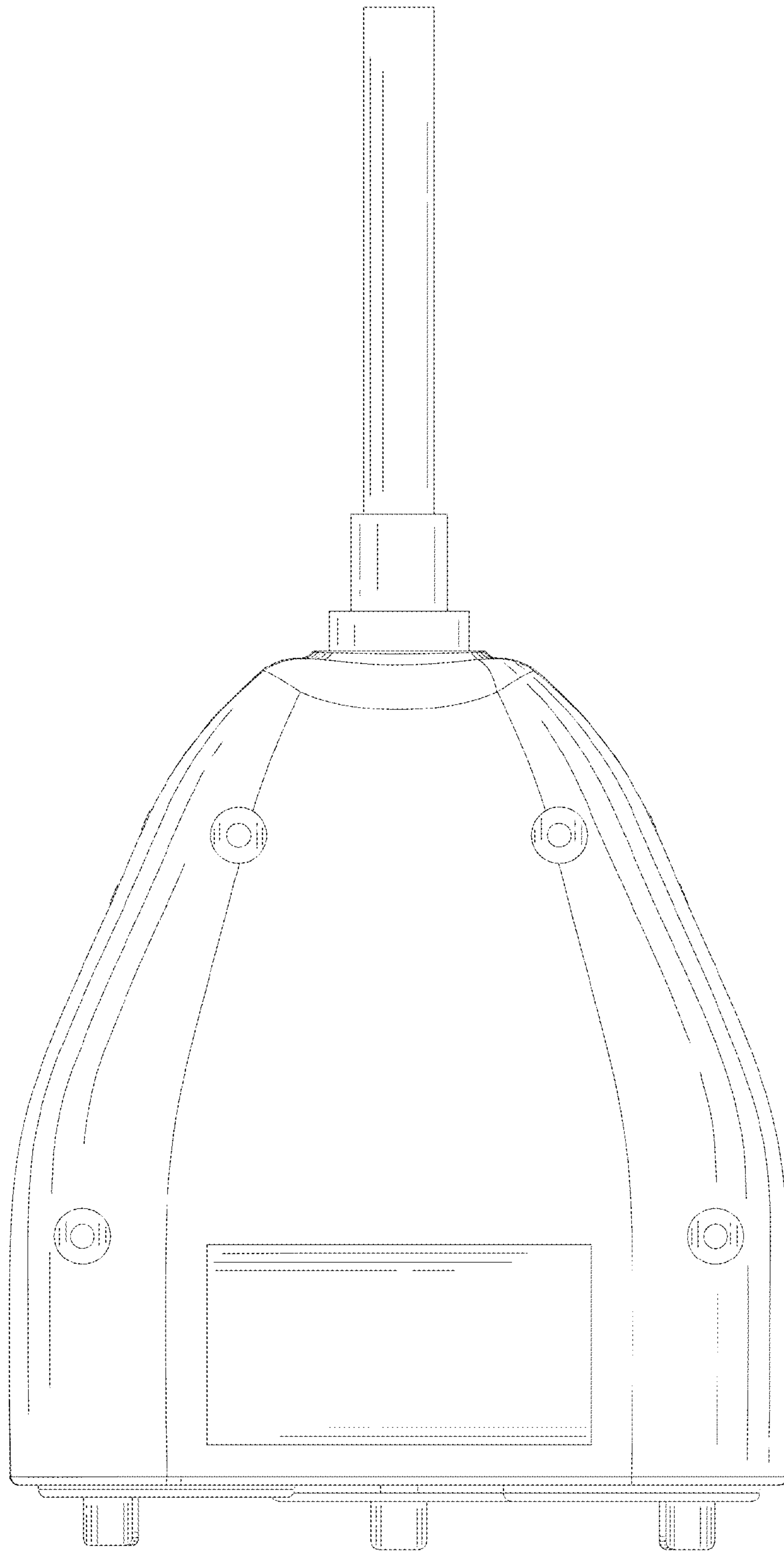

FIG. 4

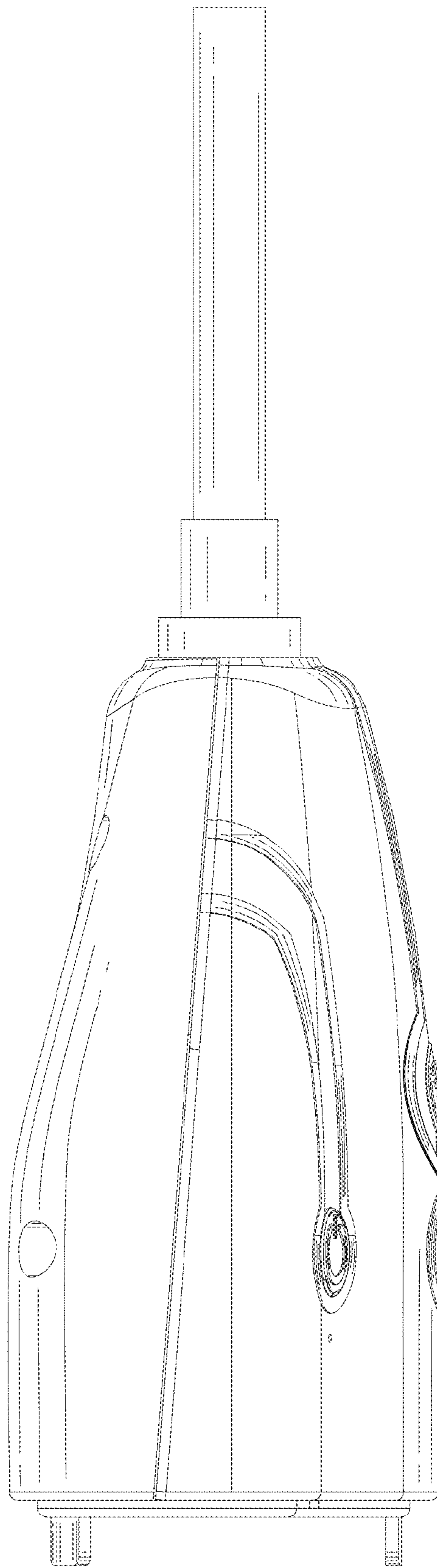

FIG. 5

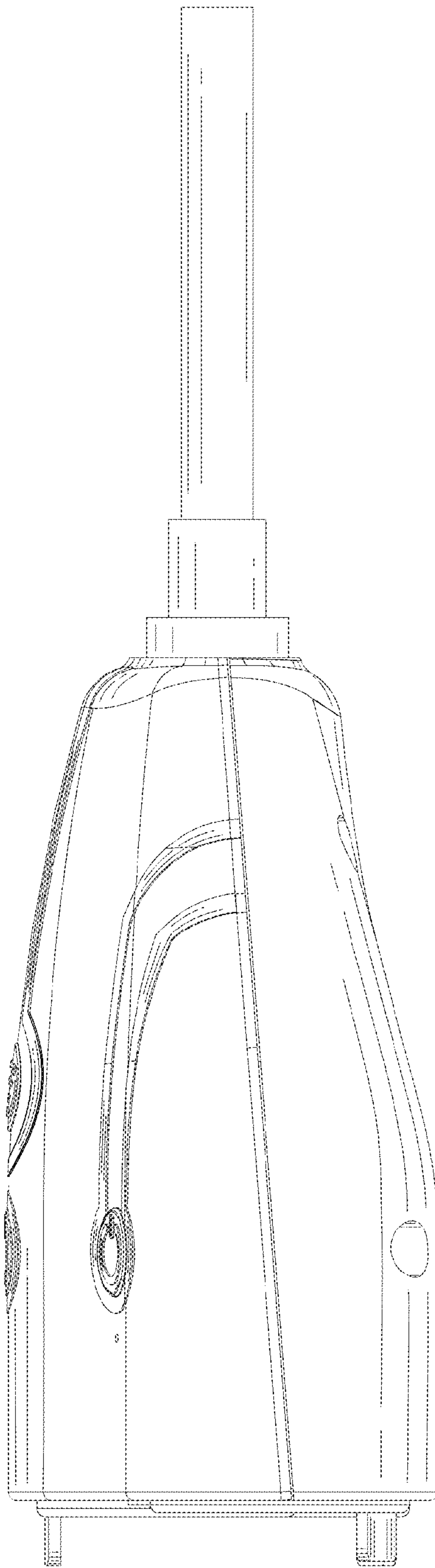

FIG. 6

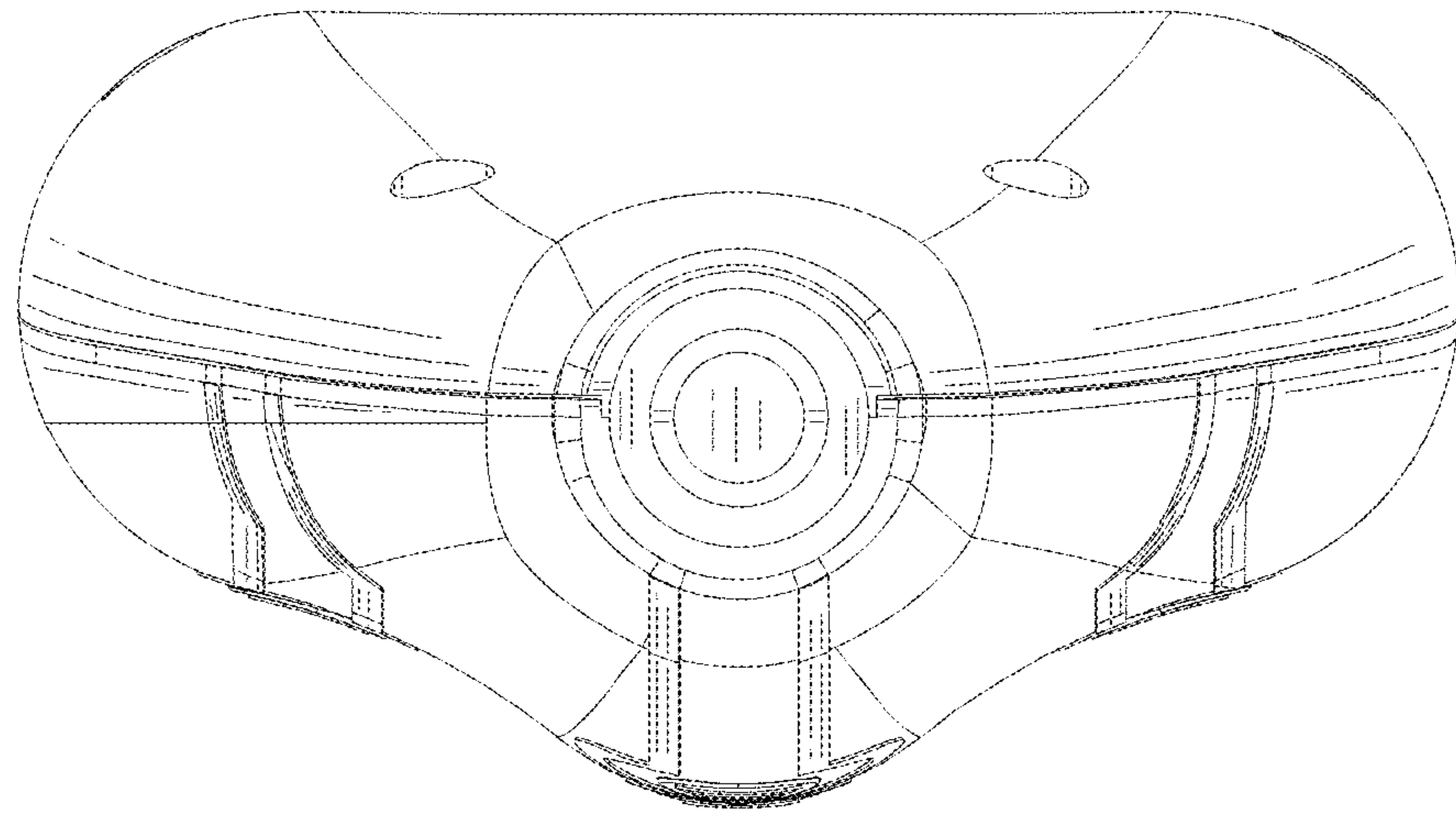

FIG. 7

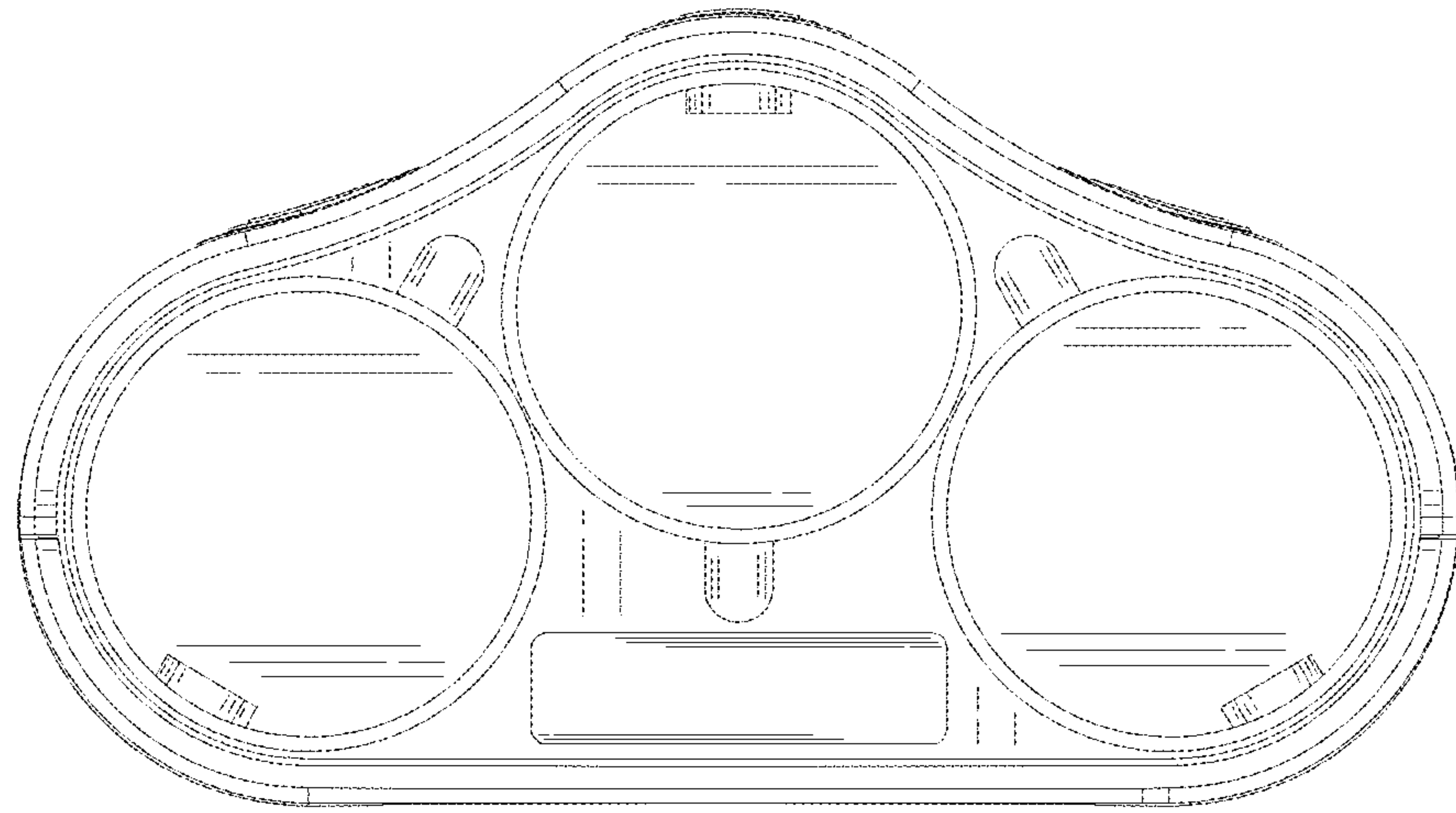

FIG. 8