



US00D957324S

(12) **United States Design Patent**
Liddell et al.

(10) **Patent No.:** **US D957,324 S**
(45) **Date of Patent:** **** Jul. 12, 2022**

(54) **CHARGING PLATE FOR AUDIO PLAYER**

(71) Applicant: **BOOGALOO AUDIO LLC**, Austin, TX (US)

(72) Inventors: **William Andrew Liddell**, Austin, TX (US); **Julie Urice Liddell**, Austin, TX (US); **Fred Bould**, Menlo Park, CA (US); **Jeremy Paul Wolf**, San Francisco, CA (US); **Lora Violinova Dimitrova**, San Francisco, CA (US); **Tristan Macpherson Cannan**, San Francisco, CA (US)

(73) Assignee: **ELLODEE INC.**, Austin, TX (US)

(**) Term: **15 Years**

(21) Appl. No.: **29/693,675**

(22) Filed: **Jun. 4, 2019**

(51) **LOC (13) Cl.** **13-02**

(52) **U.S. Cl.**
USPC **D13/108**

(58) **Field of Classification Search**
USPC D13/107–110, 118–119, 184; D14/251, D14/253, 432, 434
CPC Y02E 60/12; Y02T 90/14; Y02T 90/122; Y02T 90/128; Y02T 90/163; H02J 7/025; H02J 7/0042; H02J 7/0044; H02J 7/0045; H02J 7/0013; H02J 7/0003; H01F 38/14; H01R 13/6675; H01M 2/1022; H01M 2/1055; H01M 10/44; H01M 10/46; H01M 10/425; B60L 11/182
See application file for complete search history.

(56) **References Cited**

U.S. PATENT DOCUMENTS

D599,736 S * 9/2009 Ferber D13/108
D611,408 S * 3/2010 Ferber D13/108
D682,199 S * 5/2013 Rautiainen D13/108

D729,163 S * 5/2015 Meyer D13/123
D736,706 S * 8/2015 Huang D13/108
D807,318 S * 1/2018 Folkmann D14/149
D847,741 S * 5/2019 Hu D13/108
D856,926 S * 8/2019 Yoon D13/108
D870,658 S * 12/2019 Woo D13/108
D883,201 S * 5/2020 Chen D13/108
D883,921 S * 5/2020 Ryu D13/108

(Continued)

Primary Examiner — Nathaniel D. Buckner

(74) *Attorney, Agent, or Firm* — Norton Rose Fulbright US LLP

(57) **CLAIM**

The ornamental design for a charging plate for audio player, as shown and described.

DESCRIPTION

FIG. 1 is a top left front perspective view of a first embodiment of a charging plate for audio player showing our new design.
FIG. 2 is a bottom right rear perspective view thereof.
FIG. 3 is a front elevation view thereof.
FIG. 4 is a rear elevation view thereof.
FIG. 5 is a right side elevation view thereof.
FIG. 6 is a left side elevation view thereof.
FIG. 7 is a top plan view thereof.
FIG. 8 is a bottom plan view thereof.
FIG. 9 is a top left perspective view of a second embodiment of a charging plate for audio player showing our new design with surface ornamentation applied.
FIG. 10 is a bottom right rear perspective view thereof.
FIG. 11 is a front elevation view thereof.
FIG. 12 is a rear elevation view thereof.
FIG. 13 is a right side elevation view thereof.
FIG. 14 is a left side elevation view thereof.
FIG. 15 is a top plan view thereof; and,
FIG. 16 is a bottom plan view thereof.
The broken lines depict portions of the charging plate for audio player that form no part of the claimed design.

1 Claim, 16 Drawing Sheets

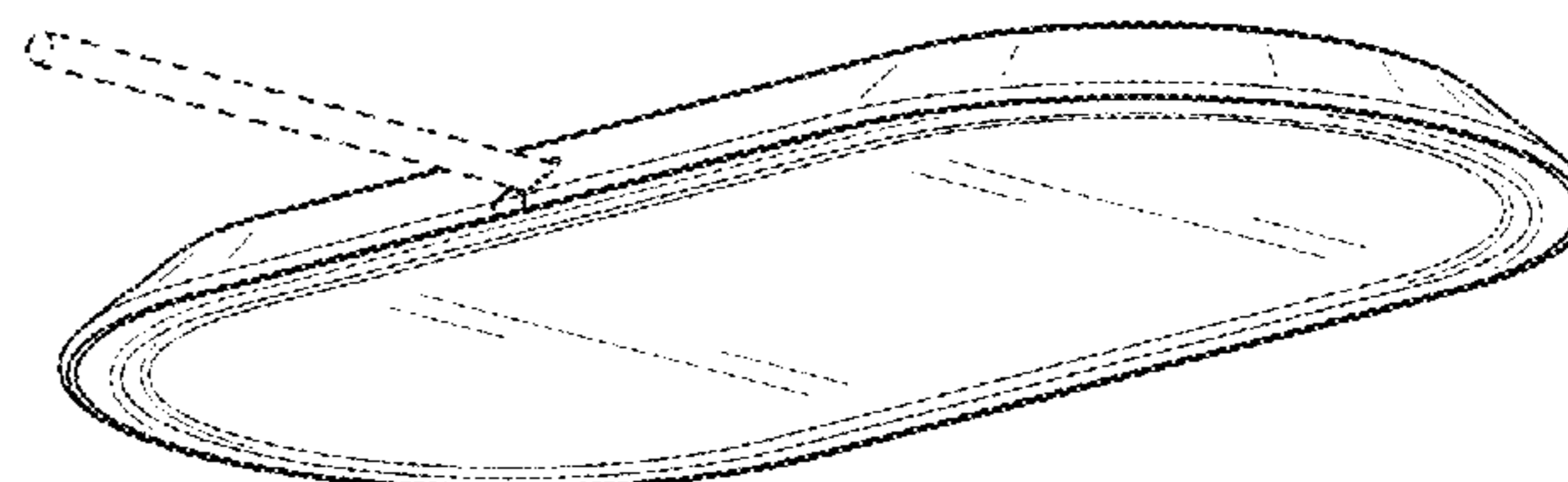
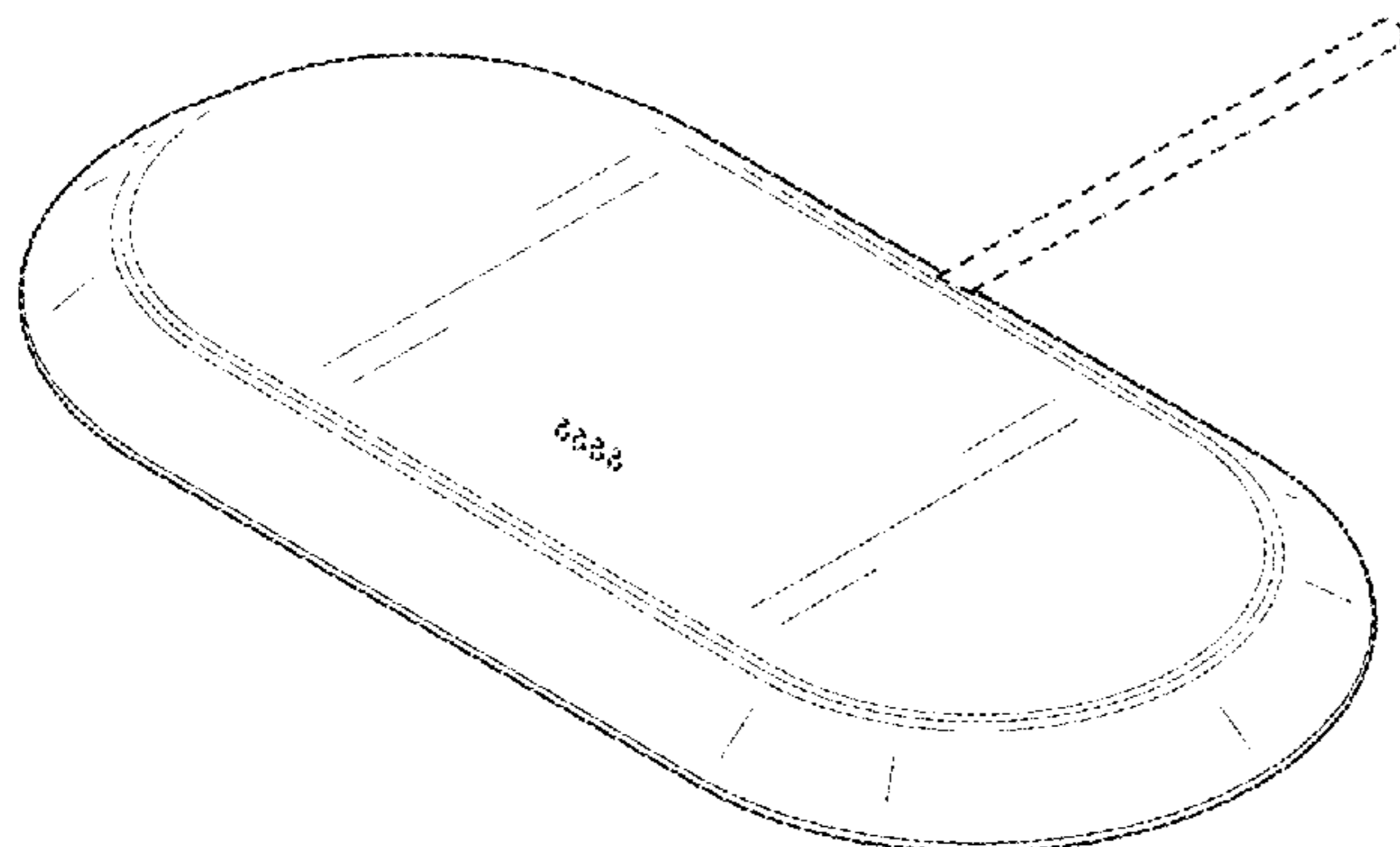

(56)

References Cited

U.S. PATENT DOCUMENTS

D894,121 S * 8/2020 Lomeli D13/107
2021/0240436 A1* 8/2021 Liddell H04R 1/023

* cited by examiner

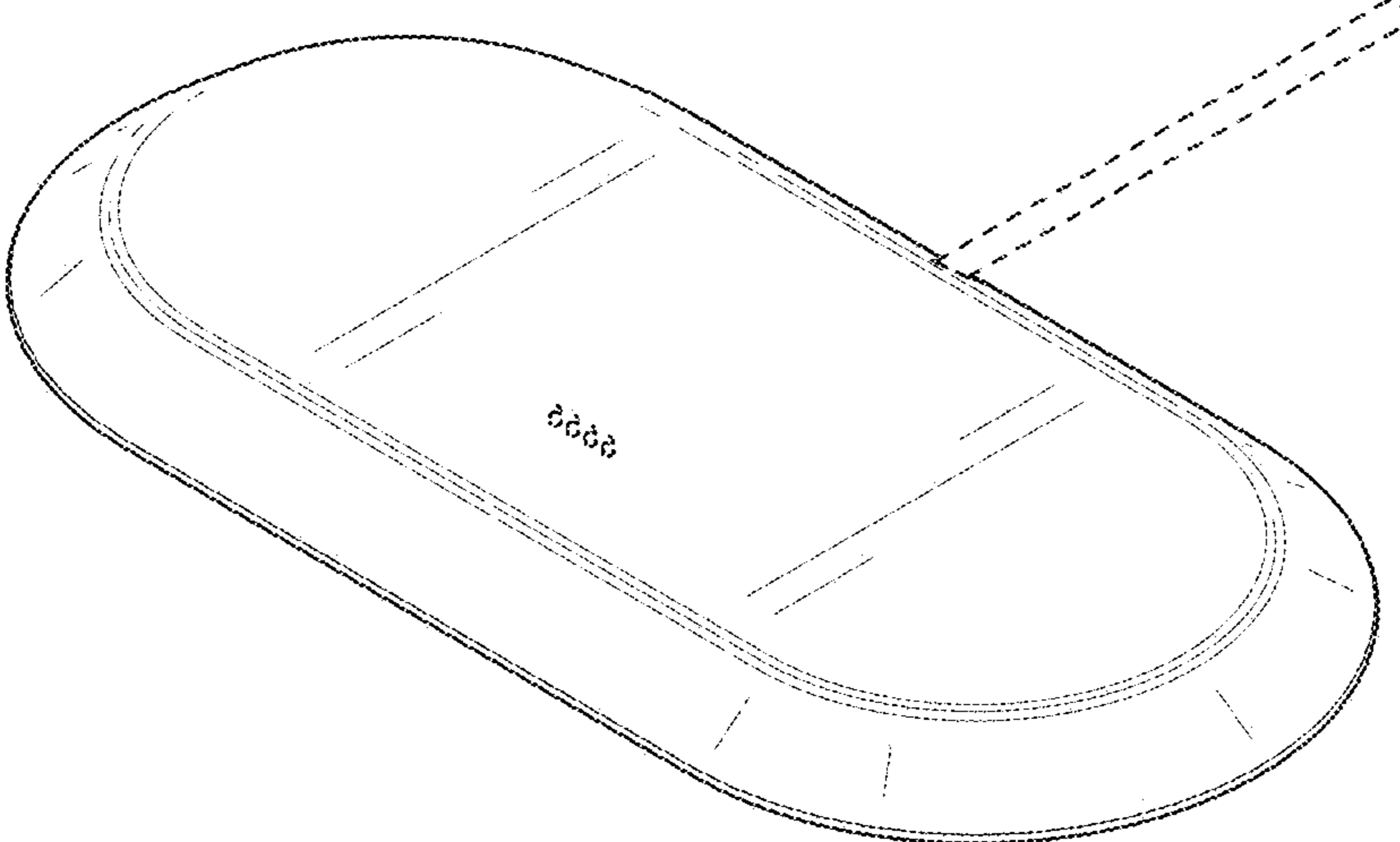

FIG. 1

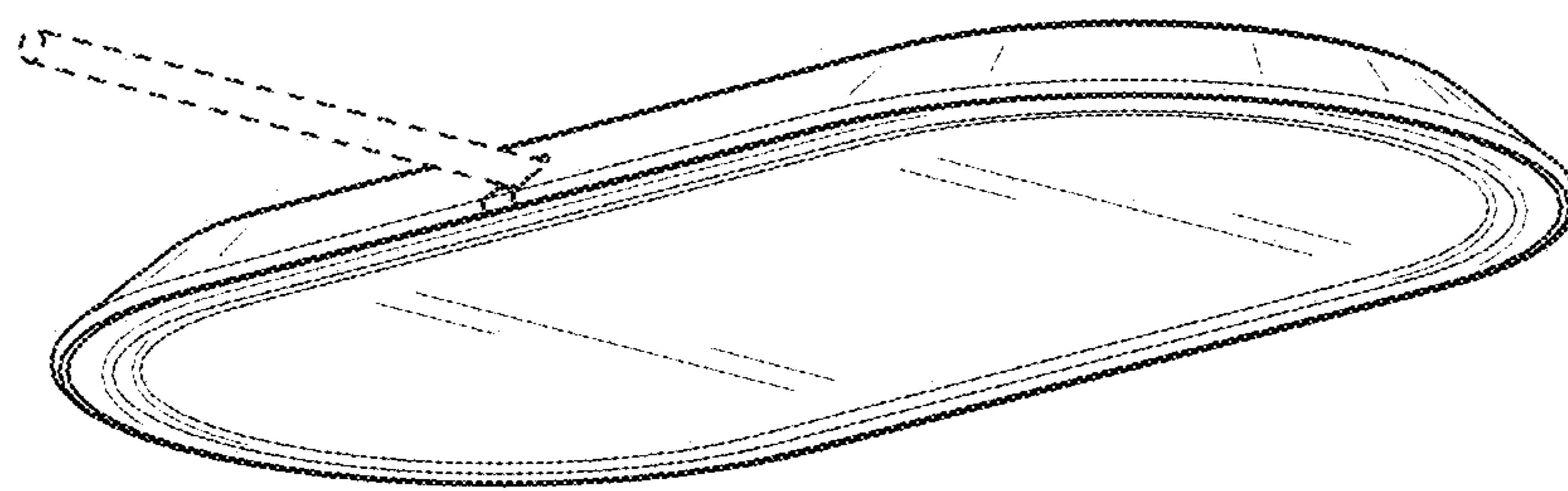

FIG. 2

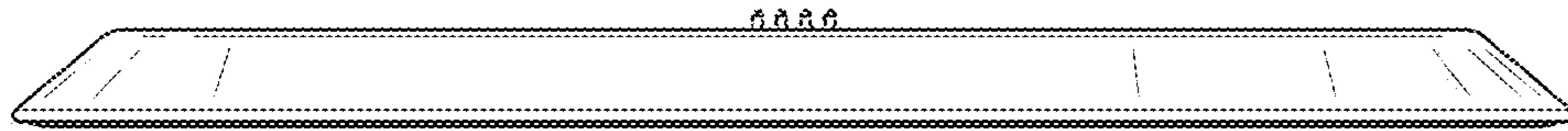

FIG. 3

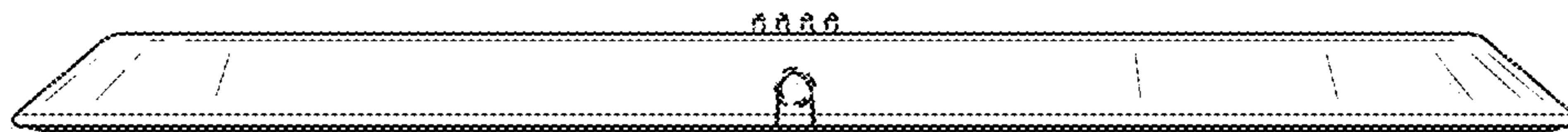

FIG. 4

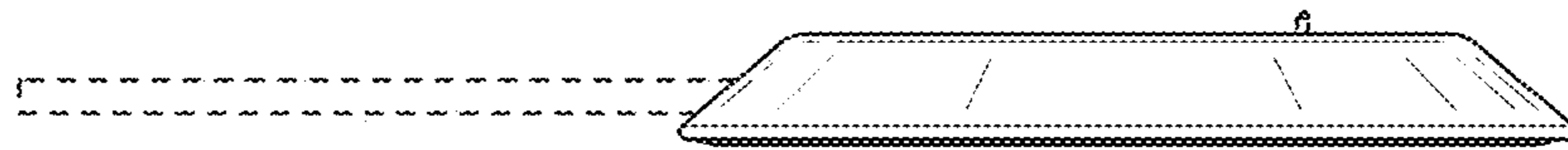

FIG. 5



FIG. 6

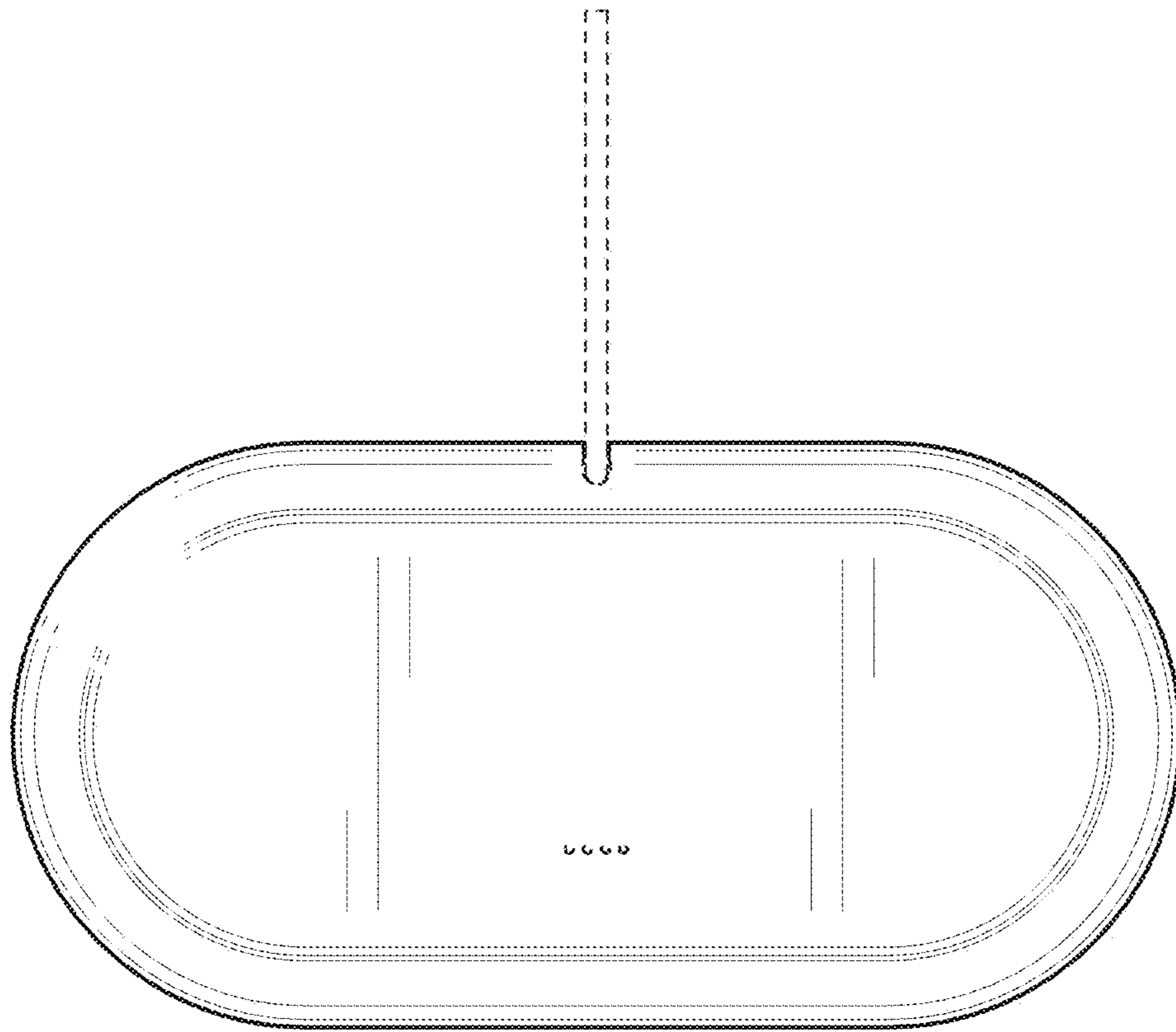

FIG. 7

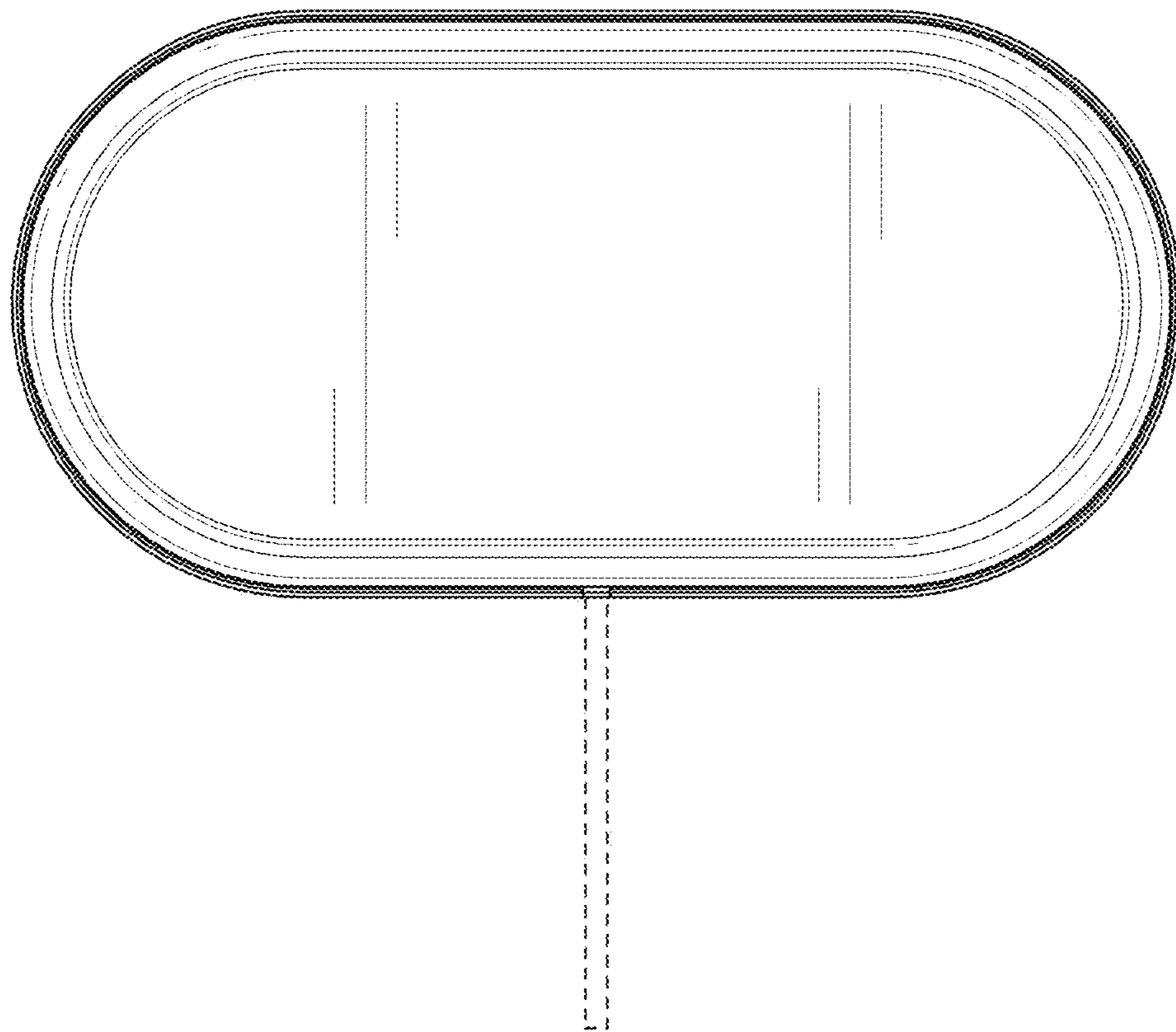

FIG. 8

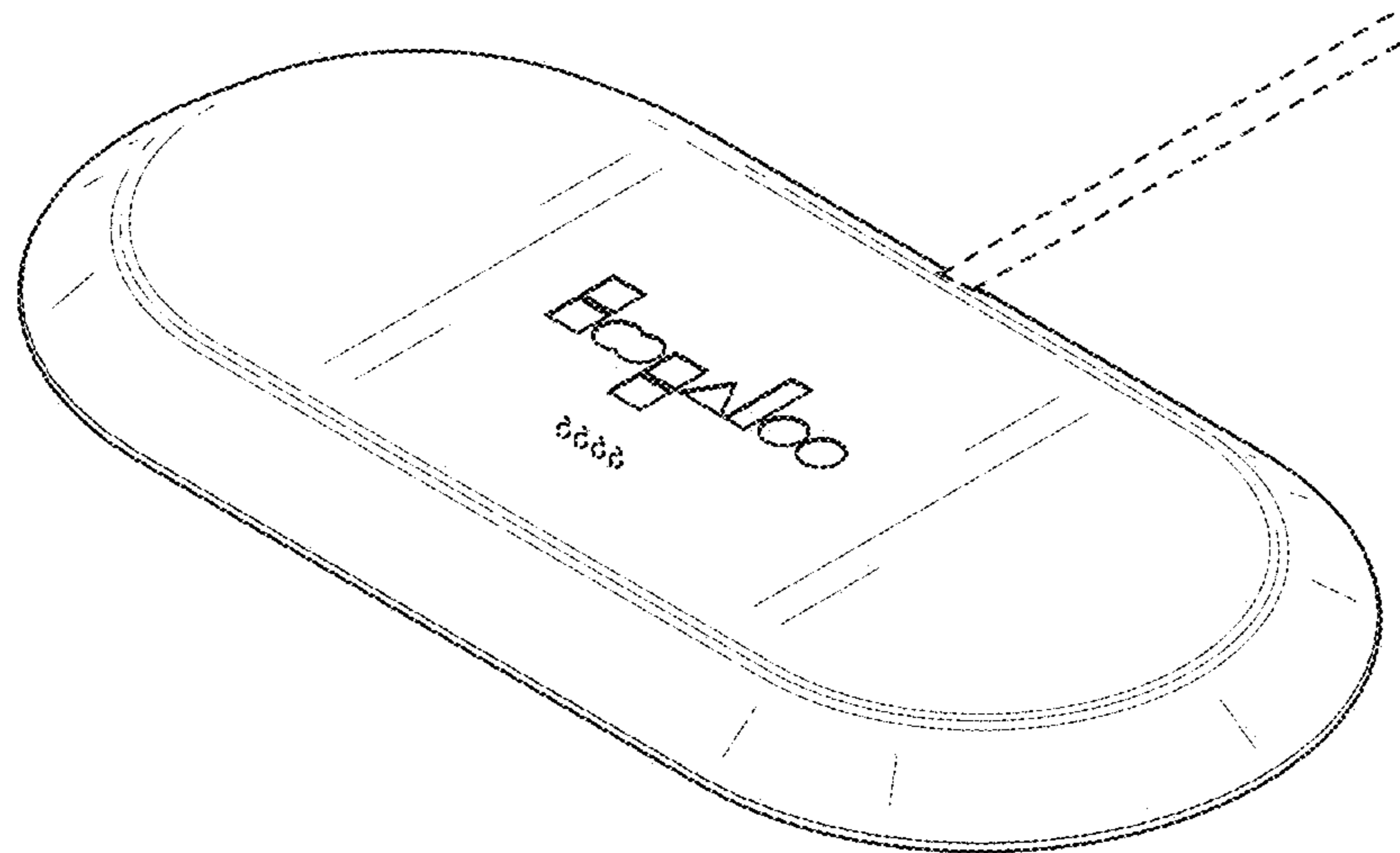

FIG. 9

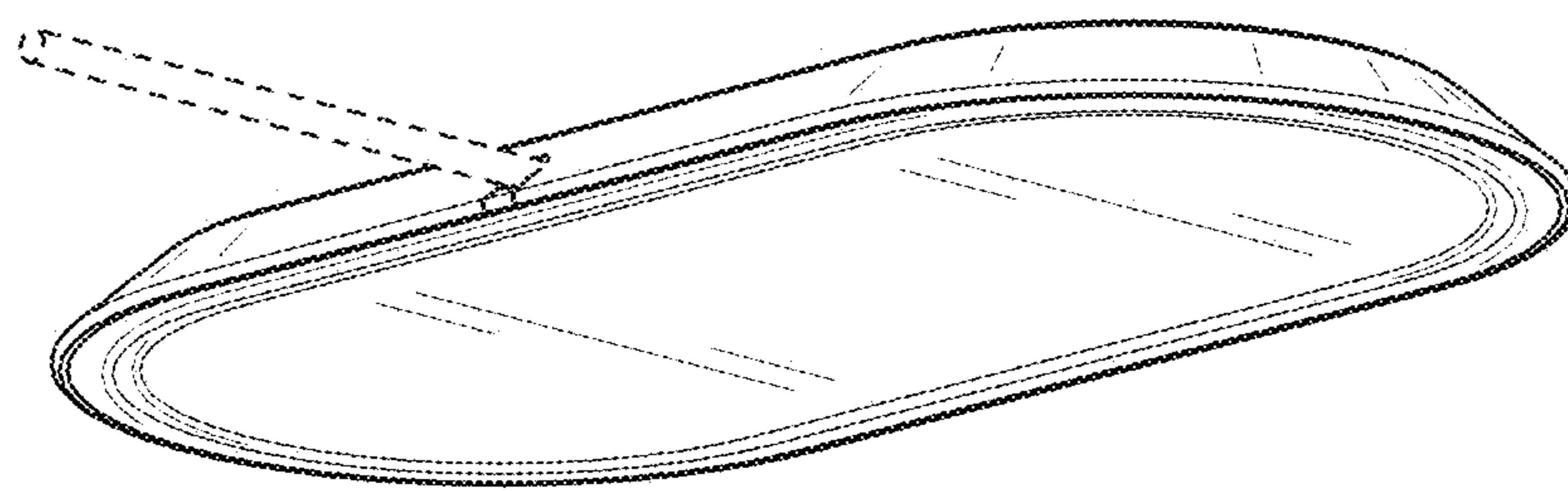

FIG. 10

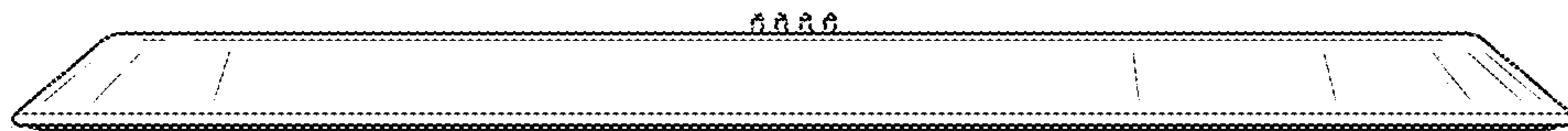

FIG. 11

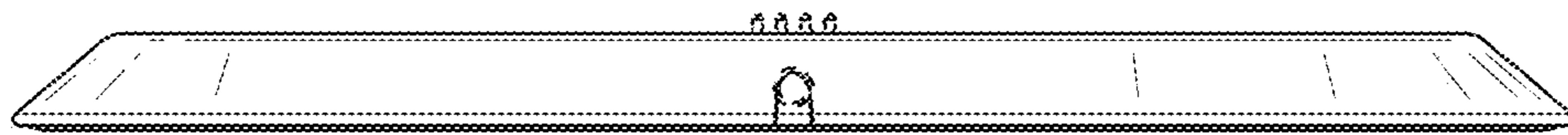

FIG. 12

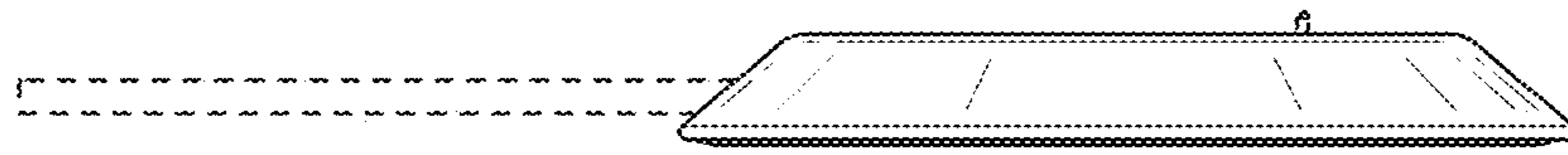

FIG. 13



FIG. 14

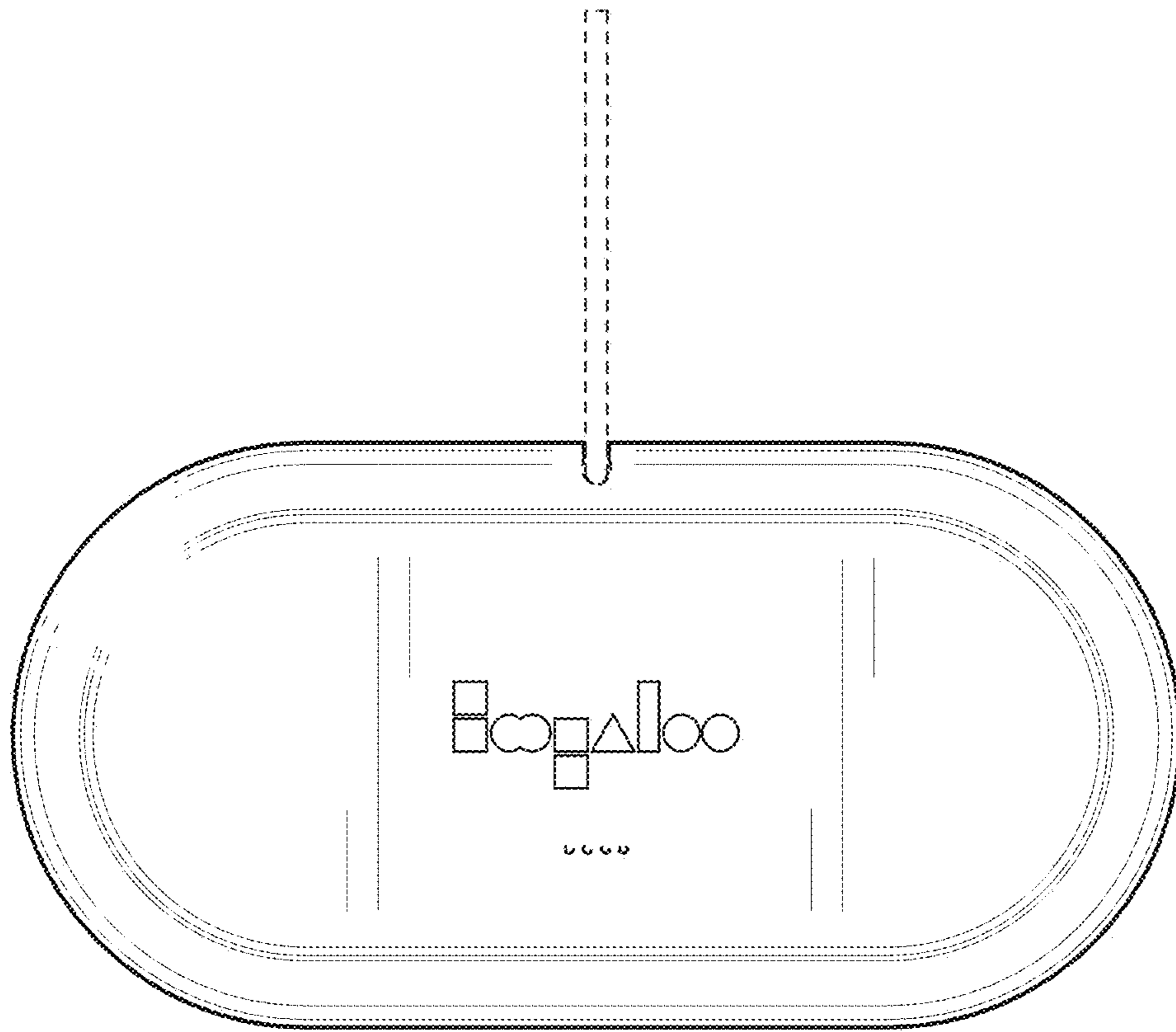

FIG. 15

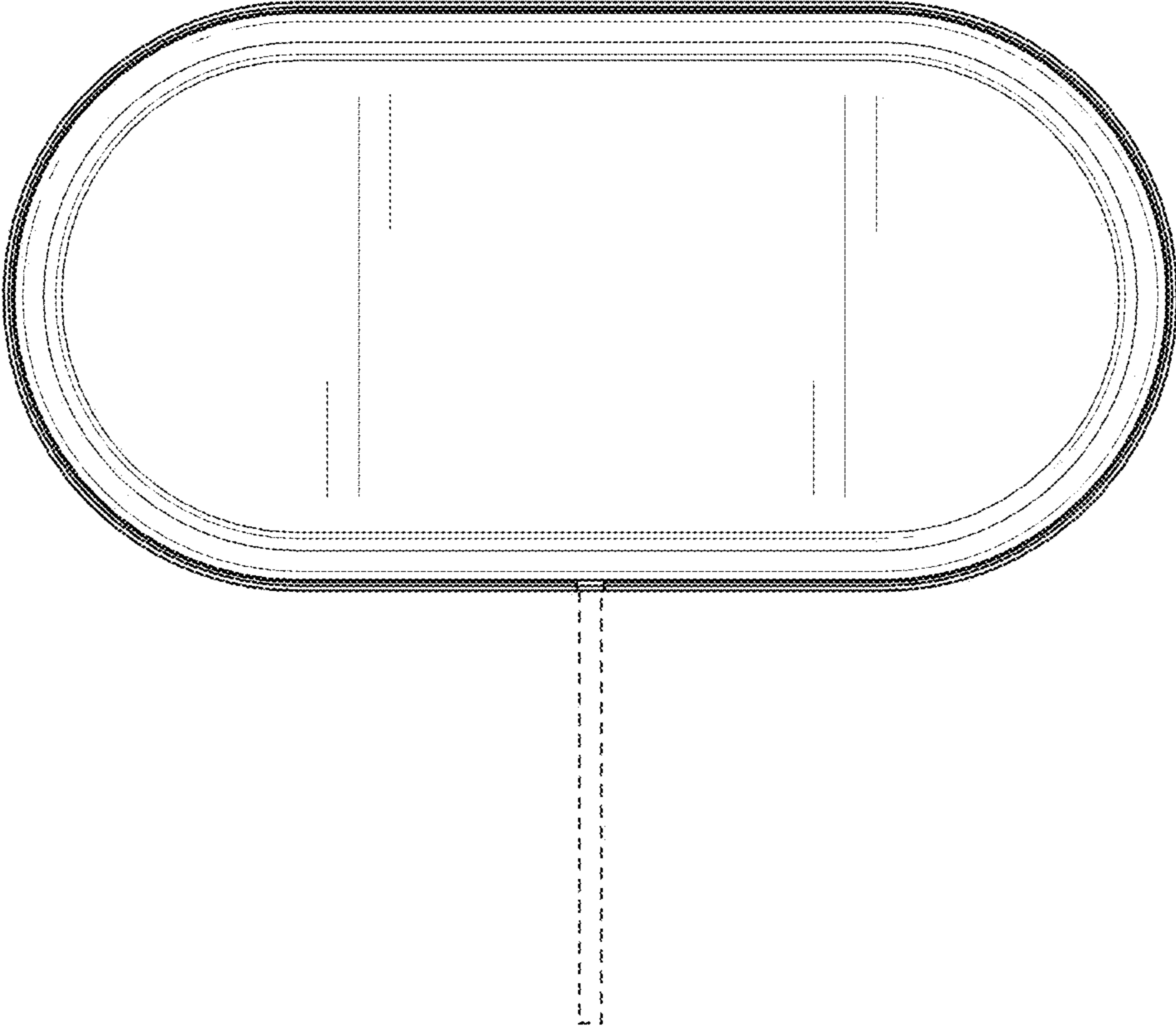

FIG. 16