



US00D957263S

(12) **United States Design Patent** (10) **Patent No.:** **US D957,263 S**
Tse (45) **Date of Patent:** **** Jul. 12, 2022**

(54) **BOTTLE HAVING DUAL CONFIGURATION**

(71) Applicant: **Berlin Packaging, LLC**, Chicago, IL (US)

(72) Inventor: **Kieron Tse**, Chicago, IL (US)

(73) Assignee: **Berlin Packaging, LLC**, Chicago, IL (US)

(**) Term: **15 Years**

(21) Appl. No.: **29/816,174**

(22) Filed: **Nov. 19, 2021**

Related U.S. Application Data

(62) Division of application No. 29/668,341, filed on Oct. 30, 2018.

(51) **LOC (13) Cl.** **09-01**

(52) **U.S. Cl.**
USPC **D9/741**

(58) **Field of Classification Search**
USPC D9/719, 737-746; D7/315
CPC B65D 1/04; B65D 2501/0081; B65D 1/0215; B65D 1/0223; B65D 1/0246; B65D 2501/009; B65D 41/04
See application file for complete search history.

(56) **References Cited**

U.S. PATENT DOCUMENTS

- 3,347,420 A * 10/1967 Donoghue G01F 11/286
222/129
- D214,549 S * 7/1969 Ledewitz D9/741
- D319,970 S * 9/1991 Beeman D9/741
- D323,108 S * 1/1992 Green D9/741
- D598,757 S * 8/2009 Farrell D9/516
- D626,434 S * 11/2010 Massin D9/743
- D795,082 S * 8/2017 Gonzalez D9/742
- D888,575 S * 6/2020 Gomez-Reyes D9/741
- D895,362 S * 9/2020 Lue D7/513
- 2016/0038959 A1 * 2/2016 Lopez B05B 11/3011
222/135

- 2016/0121538 A1* 5/2016 DiBiasio B65D 1/0223
264/515
- 2016/0122066 A1* 5/2016 DiBiasio B65D 1/04
215/6
- 2018/0319067 A1* 11/2018 Miyazawa B29C 49/185

FOREIGN PATENT DOCUMENTS

CA 187276 * 7/2020

OTHER PUBLICATIONS

Rejuvenate Window Cleaner, available Jul. 9, 2018, [online], [site visited Oct. 20, 2021]. Available from internet, URL: <https://www.amazon.com/Rejuvenate-Outdoor-Cleaner-Hose-End-Attachment/dp/B07FCRXX5X/ref=> (Year: 2018).*

* cited by examiner

Primary Examiner — W. A. Teddy Falloway

(74) *Attorney, Agent, or Firm* — Adam K. Sacharoff; Much Shelist, P.C.

(57) **CLAIM**

The ornamental design for a bottle having dual configuration, as shown and described.

DESCRIPTION

FIG. 1 is a front left side perspective view showing the new design for a bottle having dual configuration; FIG. 2 is a front, bottom side perspective view thereof; FIG. 3 is a front elevation view thereof; FIG. 4 is a rear elevation view thereof; FIG. 5 is a left side view thereof; FIG. 6 is a right side view thereof; FIG. 7 is a top plan view thereof; and, FIG. 8 is a bottom plan view thereof. The broken lines shown illustrate portions of the bottle having dual configuration and form no part of the claimed design.

1 Claim, 8 Drawing Sheets

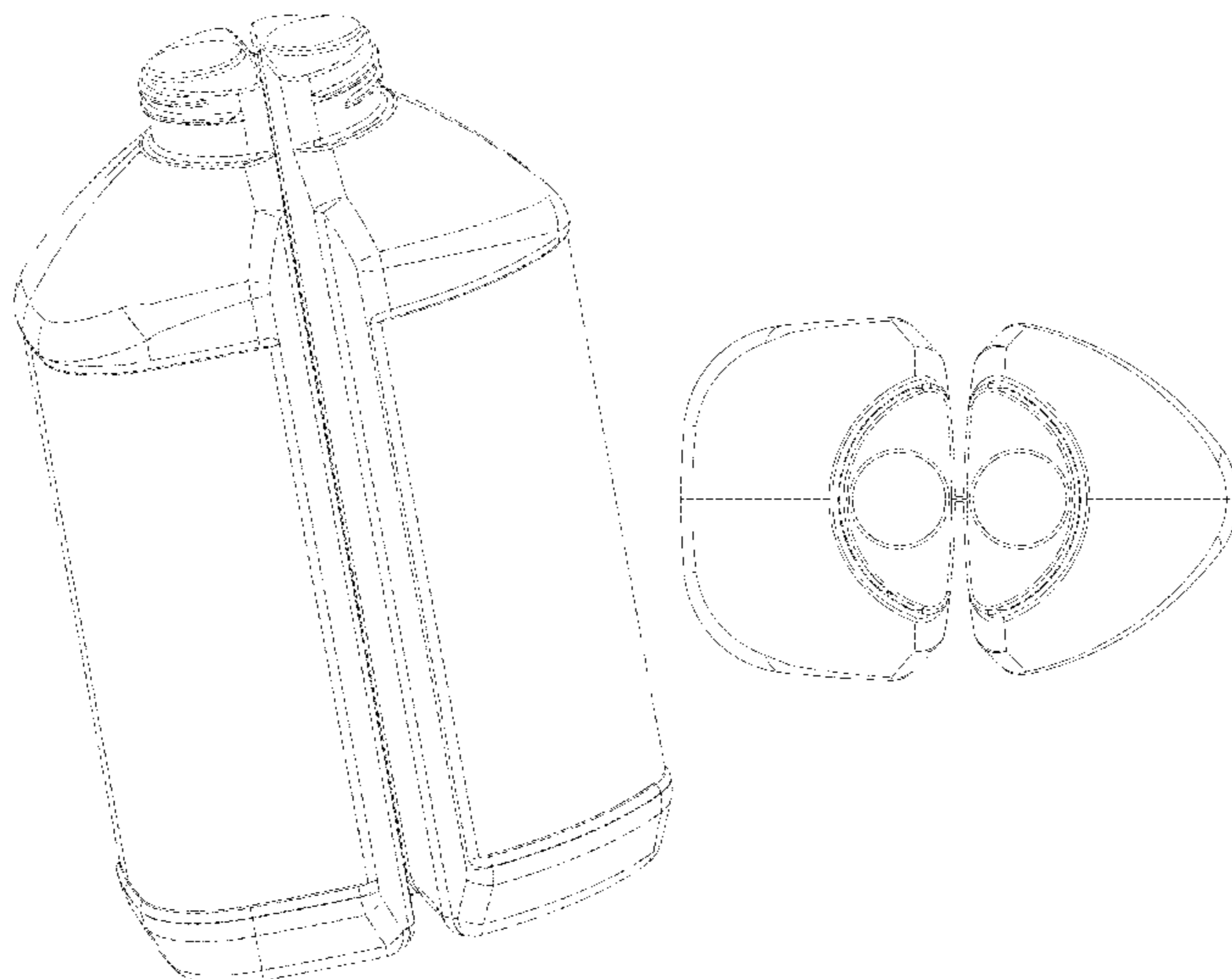

FIG. 1



FIG. 2

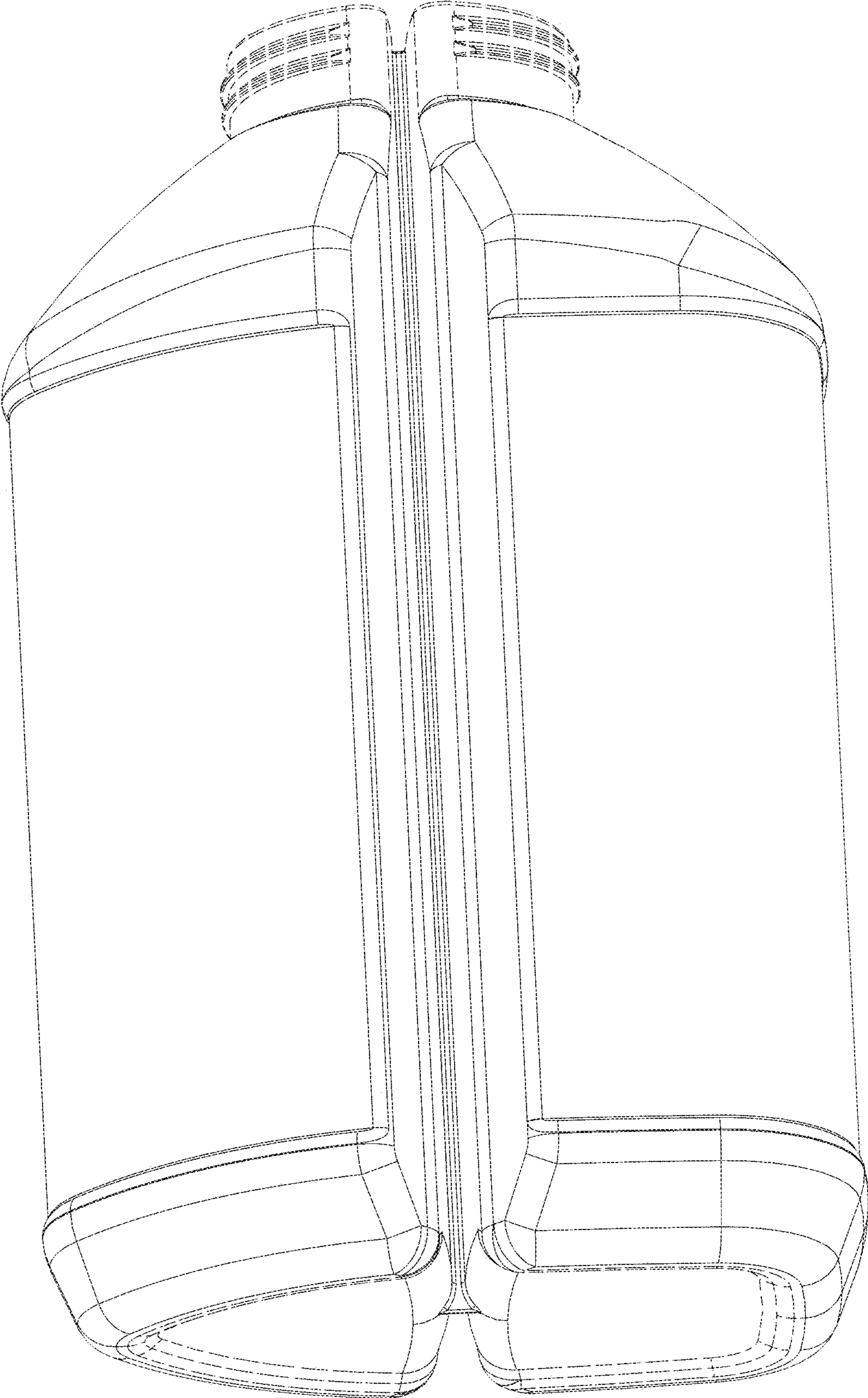

FIG. 3

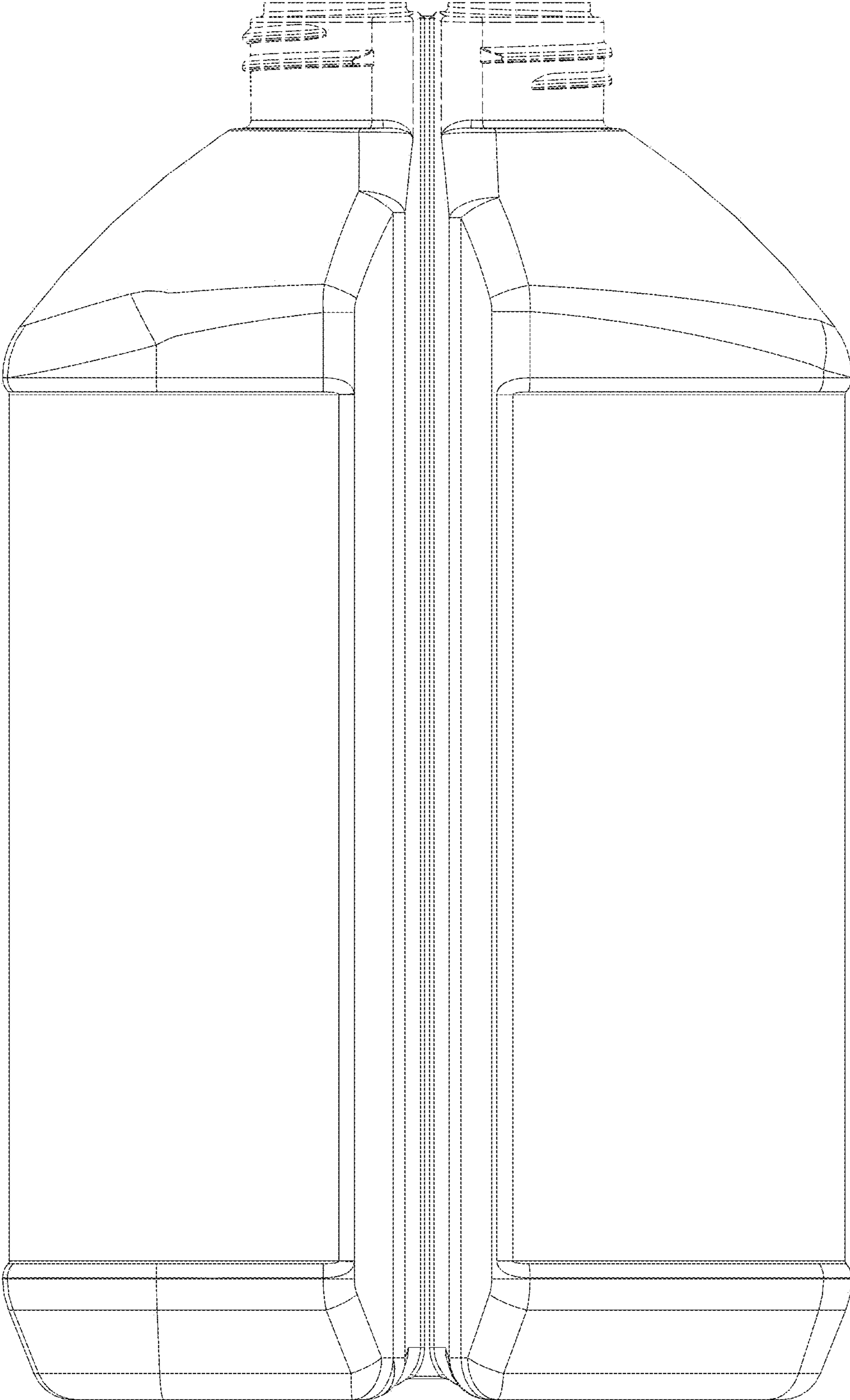

FIG. 4

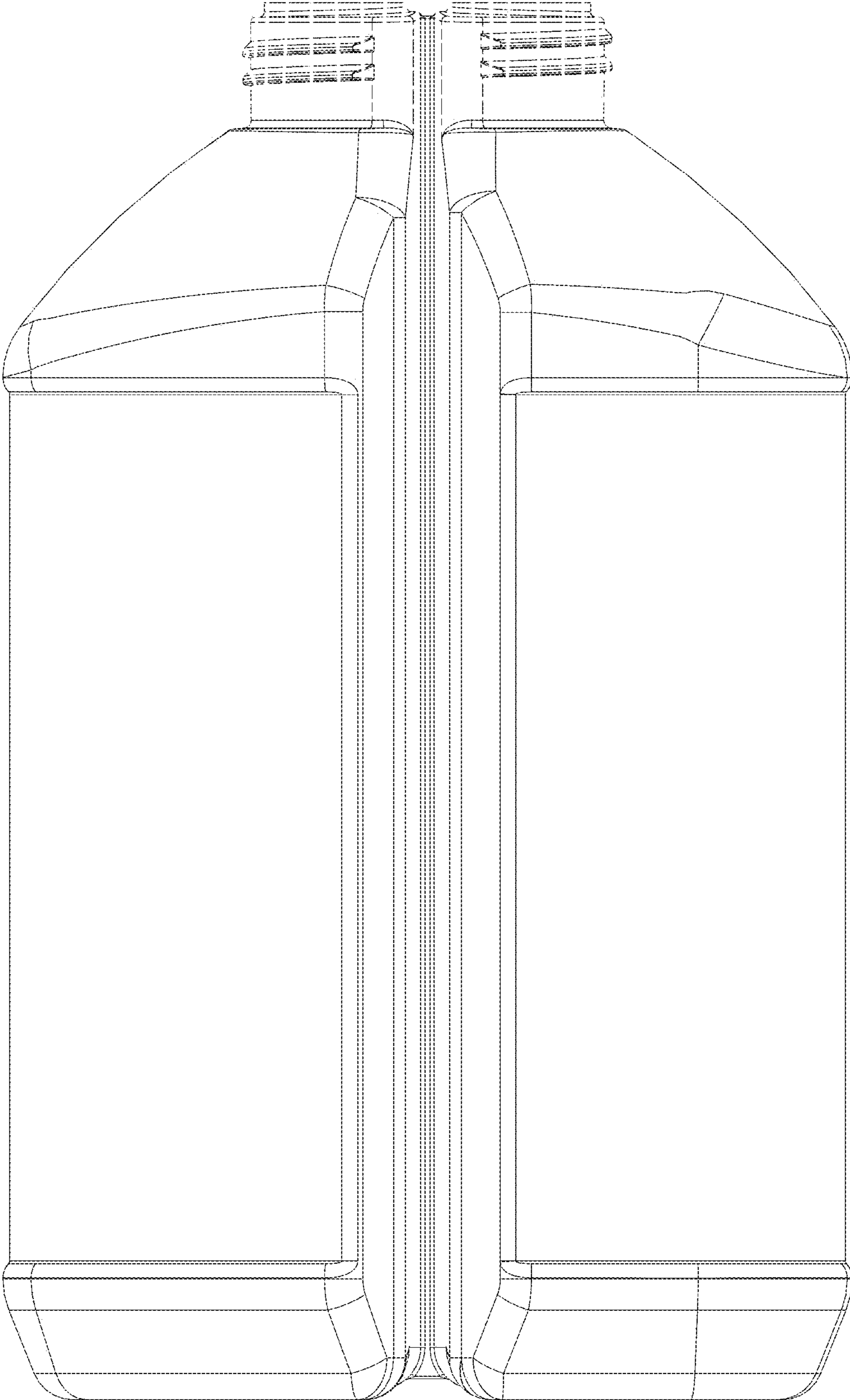

FIG. 5

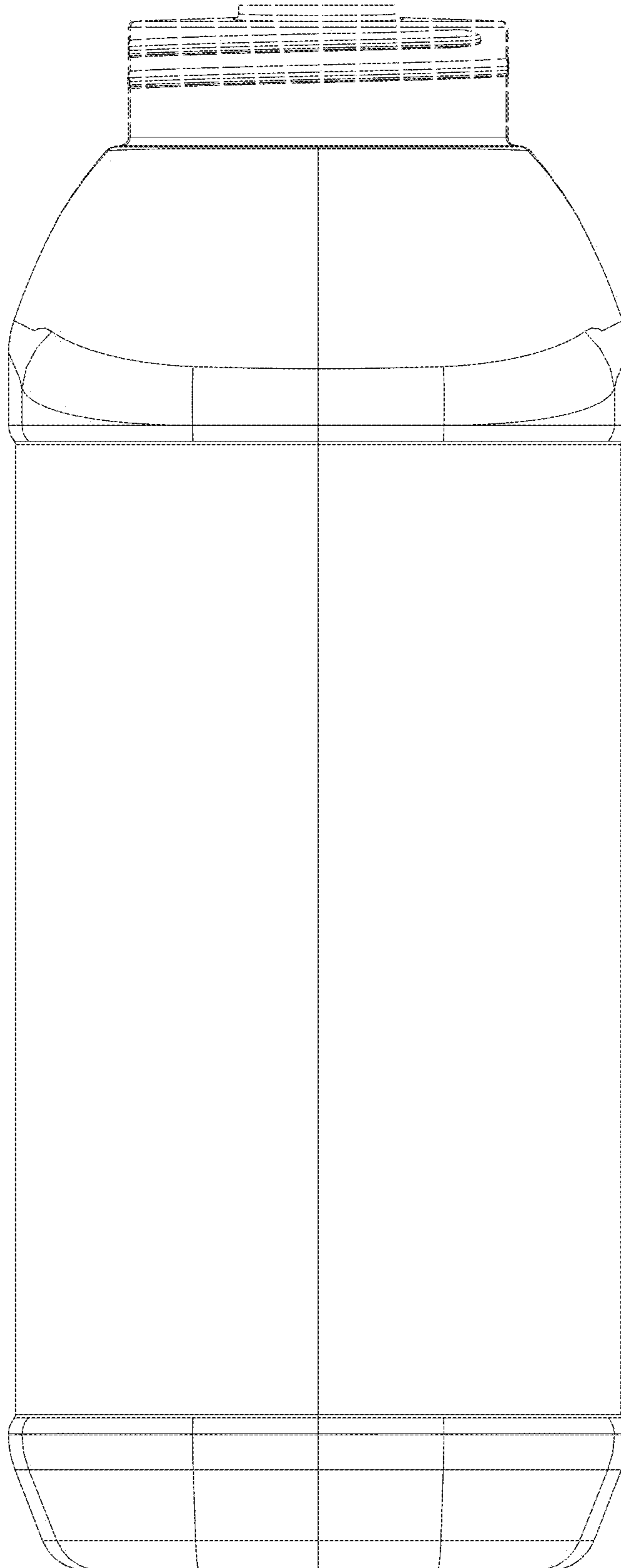

FIG. 6

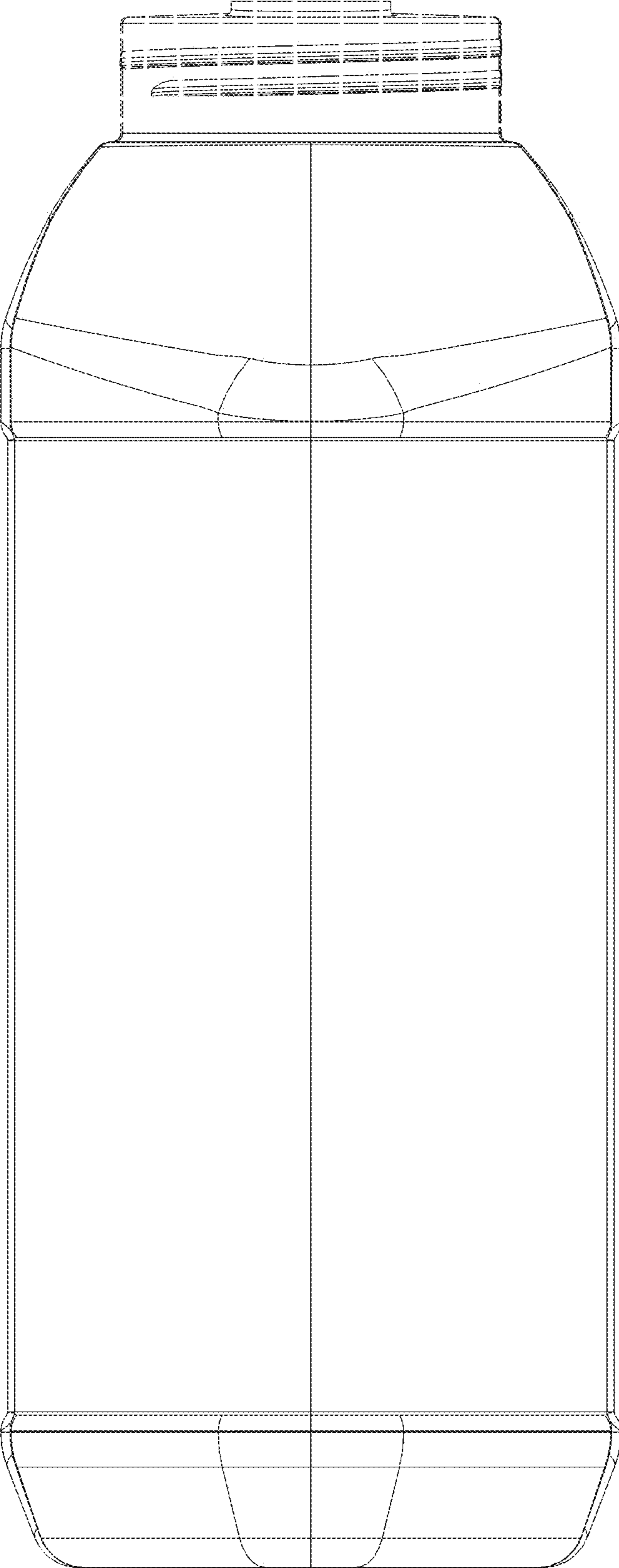

FIG. 7

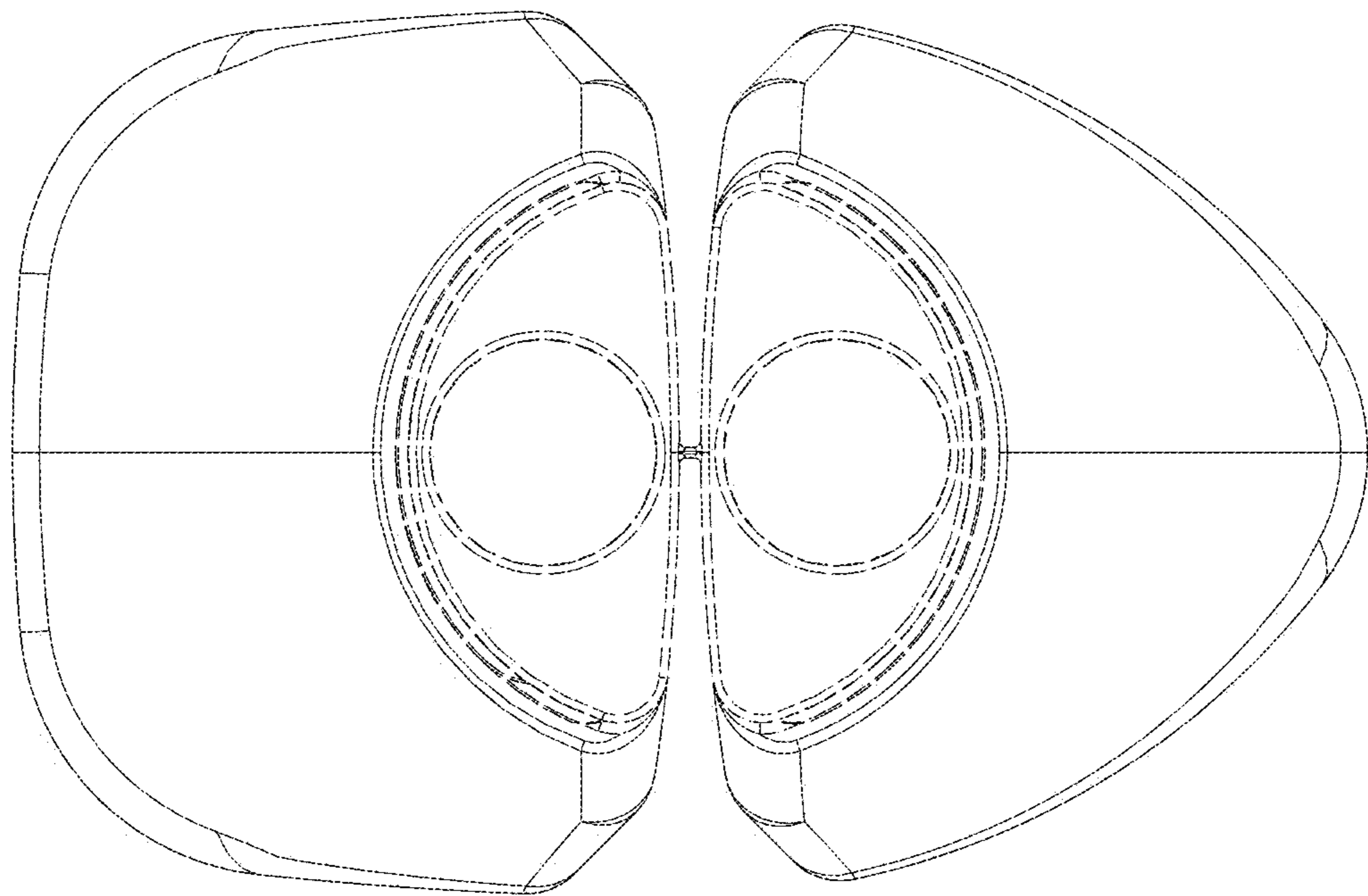

FIG. 8

