



US00D957262S

(12) **United States Design Patent** (10) **Patent No.:** **US D957,262 S**  
**Tse** (45) **Date of Patent:** **\*\* Jul. 12, 2022**

(54) **BOTTLE HAVING DUAL CONFIGURATION**

(71) Applicant: **Berlin Packaging, LLC**, Chicago, IL (US)  
(72) Inventor: **Kieron Tse**, Chicago, IL (US)  
(73) Assignee: **Berlin Packaging, LLC**, Chicago, IL (US)  
(\*\*) Term: **15 Years**

(21) Appl. No.: **29/668,341**

(22) Filed: **Oct. 30, 2018**

(51) **LOC (13) Cl.** ..... **09-01**

(52) **U.S. Cl.**  
USPC ..... **D9/741**

(58) **Field of Classification Search**  
USPC ..... D9/719, 737-746; D7/315  
CPC ..... B65D 1/04; B65D 2501/0081; B65D 1/0215; B65D 1/0223; B65D 1/0246; B65D 2501/009; B65D 41/04  
See application file for complete search history.

(56) **References Cited**

**U.S. PATENT DOCUMENTS**

3,347,420 A \* 10/1967 Donoghue ..... G01F 11/286  
222/129  
D214,549 S \* 7/1969 Ledewitz ..... D9/741  
D319,970 S \* 9/1991 Beeman ..... D9/741  
D323,108 S \* 1/1992 Green ..... D9/741  
D598,757 S \* 8/2009 Farrell ..... D9/516  
D626,434 S \* 11/2010 Massin ..... D9/743  
D795,082 S \* 8/2017 Gonzalez ..... D9/742  
D888,575 S \* 6/2020 Gomez-Reyes ..... D9/741  
D895,362 S \* 9/2020 Lue ..... D7/513  
2016/0038959 A1 \* 2/2016 Lopez ..... B05B 11/3011  
222/135  
2016/0121538 A1 \* 5/2016 DiBiasio ..... B65D 1/0223  
264/515

(Continued)

**FOREIGN PATENT DOCUMENTS**

CA 187276 \* 7/2020

**OTHER PUBLICATIONS**

Rejuvenate Window Cleaner, available Jul. 9, 2018, [online], [site visited Oct. 20, 2021]. Available from internet, URL: [https://www.amazon.com/Rejuvenate-Outdoor-Cleaner-Hose-End-Attachment/dp/B07FCRXX5X/ref=asc\\_df\\_B07FCRXX5X/?tag=hyprod-20&linkCode=df0&hvadid=507697248479&hvpos=&hvnetw=g&hvrnd=4439419792237959075&hvpone=&hvptwo=&hvqmt=&hvdev=c&hvdvcmdl=&hvlocint=&hvlocphy=9059726&hvtargid=pla-1239247198052&pssc=1](https://www.amazon.com/Rejuvenate-Outdoor-Cleaner-Hose-End-Attachment/dp/B07FCRXX5X/ref=asc_df_B07FCRXX5X/?tag=hyprod-20&linkCode=df0&hvadid=507697248479&hvpos=&hvnetw=g&hvrnd=4439419792237959075&hvpone=&hvptwo=&hvqmt=&hvdev=c&hvdvcmdl=&hvlocint=&hvlocphy=9059726&hvtargid=pla-1239247198052&pssc=1) (Year: 2018).\*

*Primary Examiner* — W. A. Teddy Falloway

(74) *Attorney, Agent, or Firm* — Adam K. Sacharoff; Much Shelist, P.C.

(57) **CLAIM**

The ornamental design for a bottle having dual configuration, as shown and described.

**DESCRIPTION**

FIG. 1 is a front left side perspective view showing the new design for a bottle having dual configuration;  
FIG. 2 is a front, bottom side perspective view thereof;  
FIG. 3 is a front elevation view thereof;  
FIG. 4 is a rear elevation view thereof;  
FIG. 5 is a left side view thereof;  
FIG. 6 is a right side view thereof;  
FIG. 7 is a top plan view thereof;  
FIG. 8 is a bottom plan view thereof;  
FIG. 9 is a front left side perspective view showing another embodiment for the new design;  
FIG. 10 is a front, bottom side perspective view thereof;  
FIG. 11 is a front elevation view thereof;  
FIG. 12 is a rear elevation view thereof;  
FIG. 13 is a left side view thereof;  
FIG. 14 is a right side view thereof;  
FIG. 15 is a top plan view thereof; and,  
FIG. 16 is a bottom plan view thereof.  
The broken lines shown illustrate portions of the bottle having dual configuration and form no part of the claimed design.

**1 Claim, 16 Drawing Sheets**

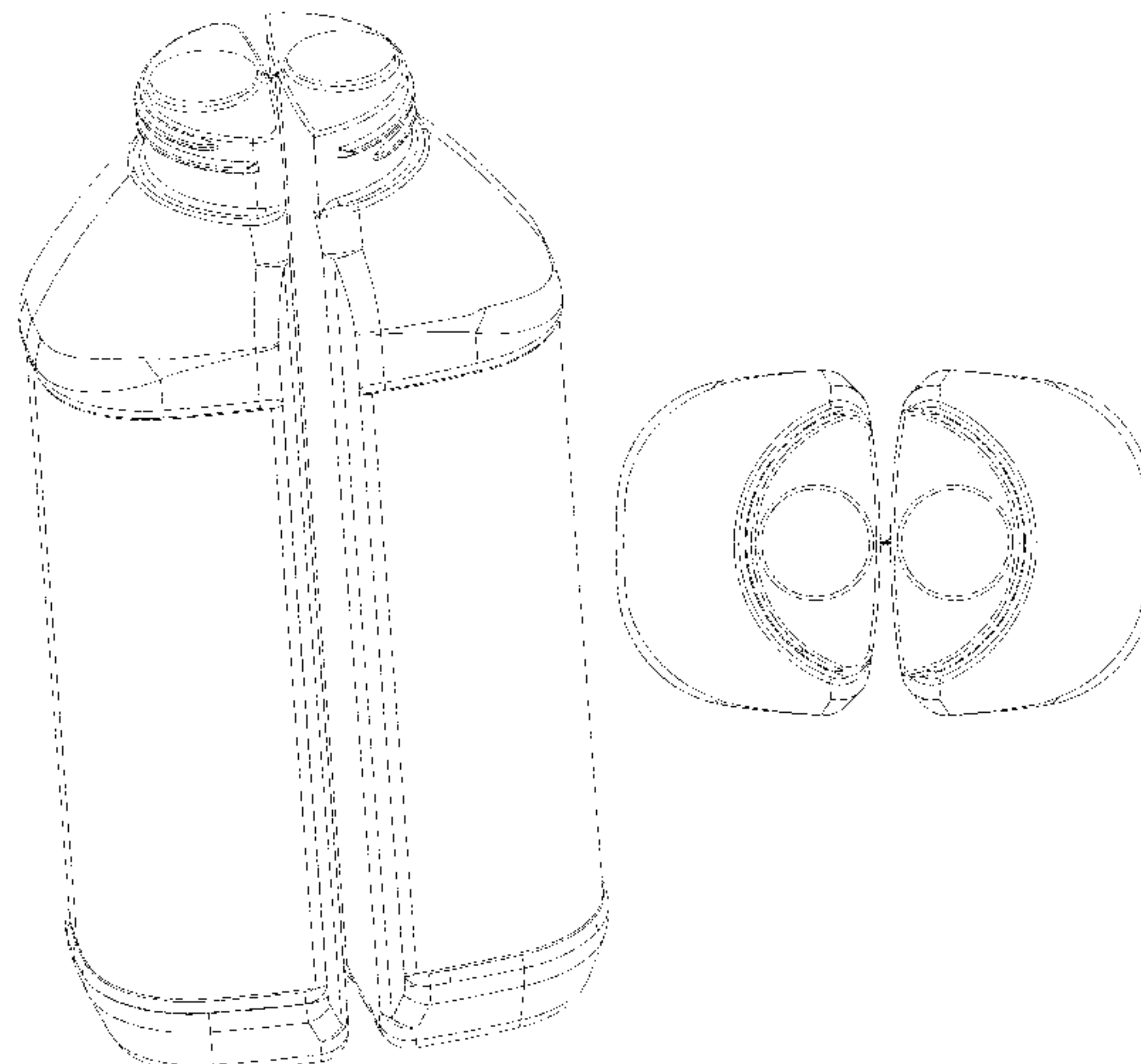

(56)

**References Cited**

U.S. PATENT DOCUMENTS

2016/0122066 A1\* 5/2016 DiBiasio ..... B65D 1/04  
215/6  
2018/0319067 A1\* 11/2018 Miyazawa ..... B29C 49/185

\* cited by examiner

FIG. 1

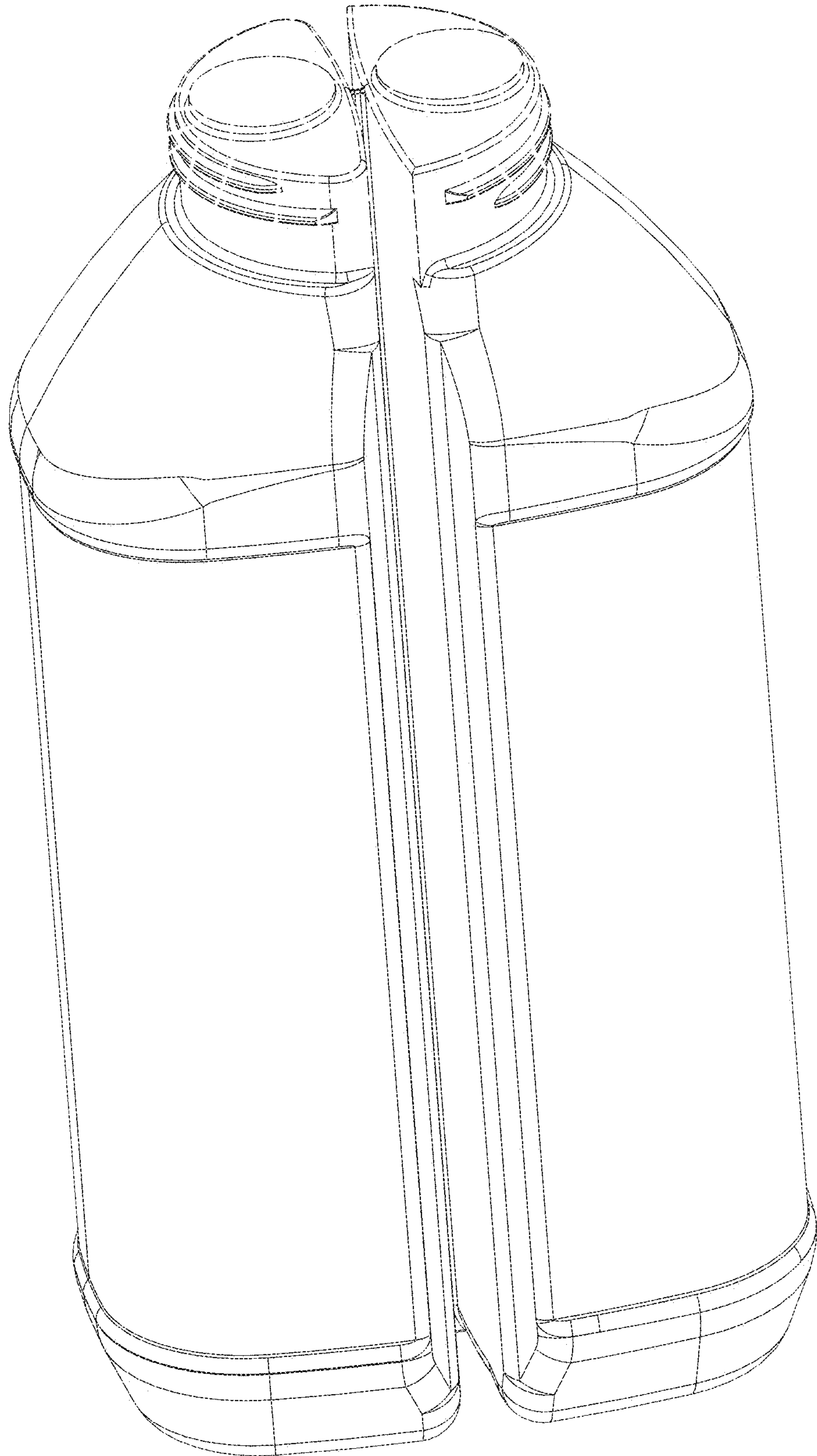

FIG. 2

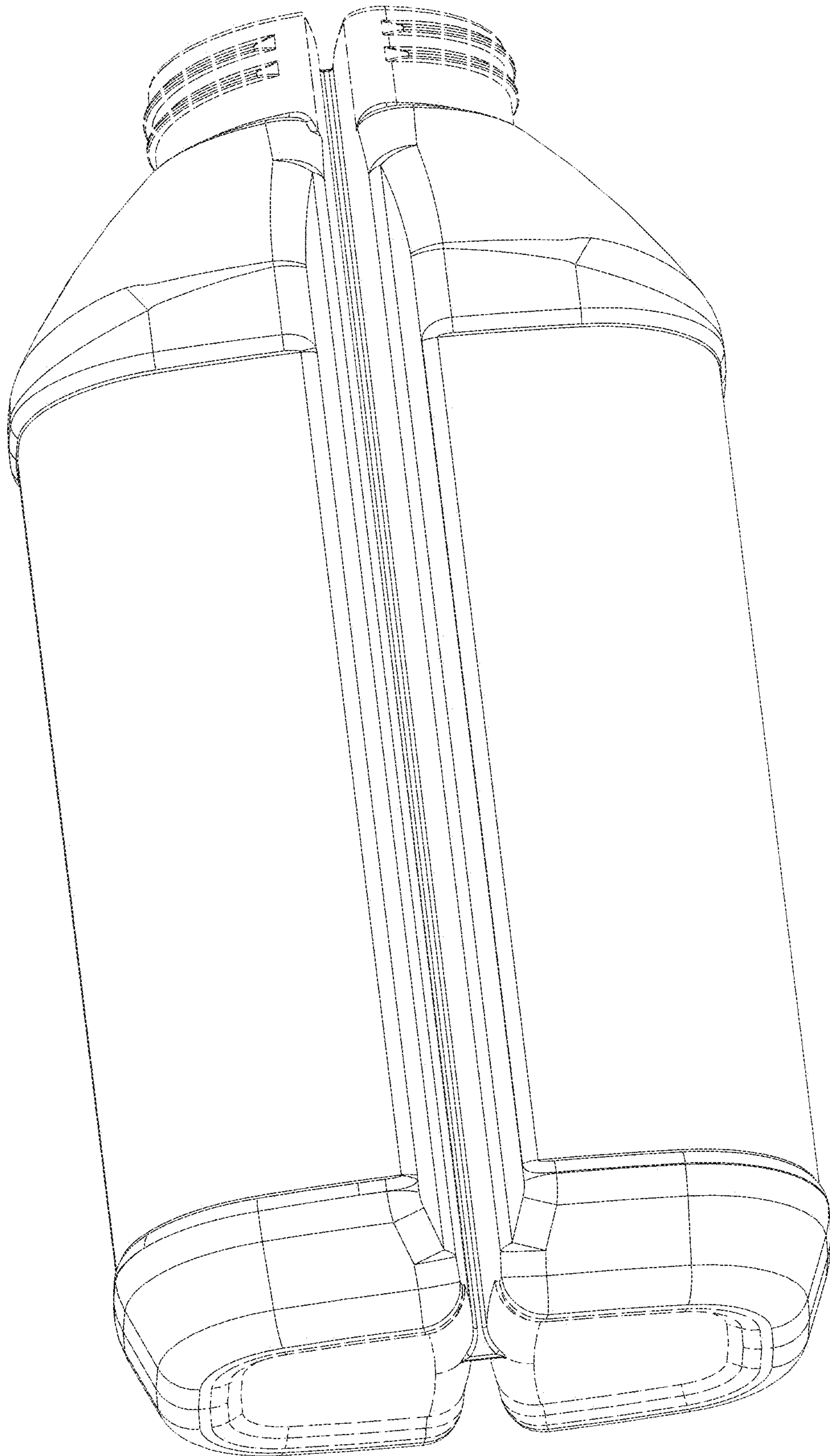



FIG. 3

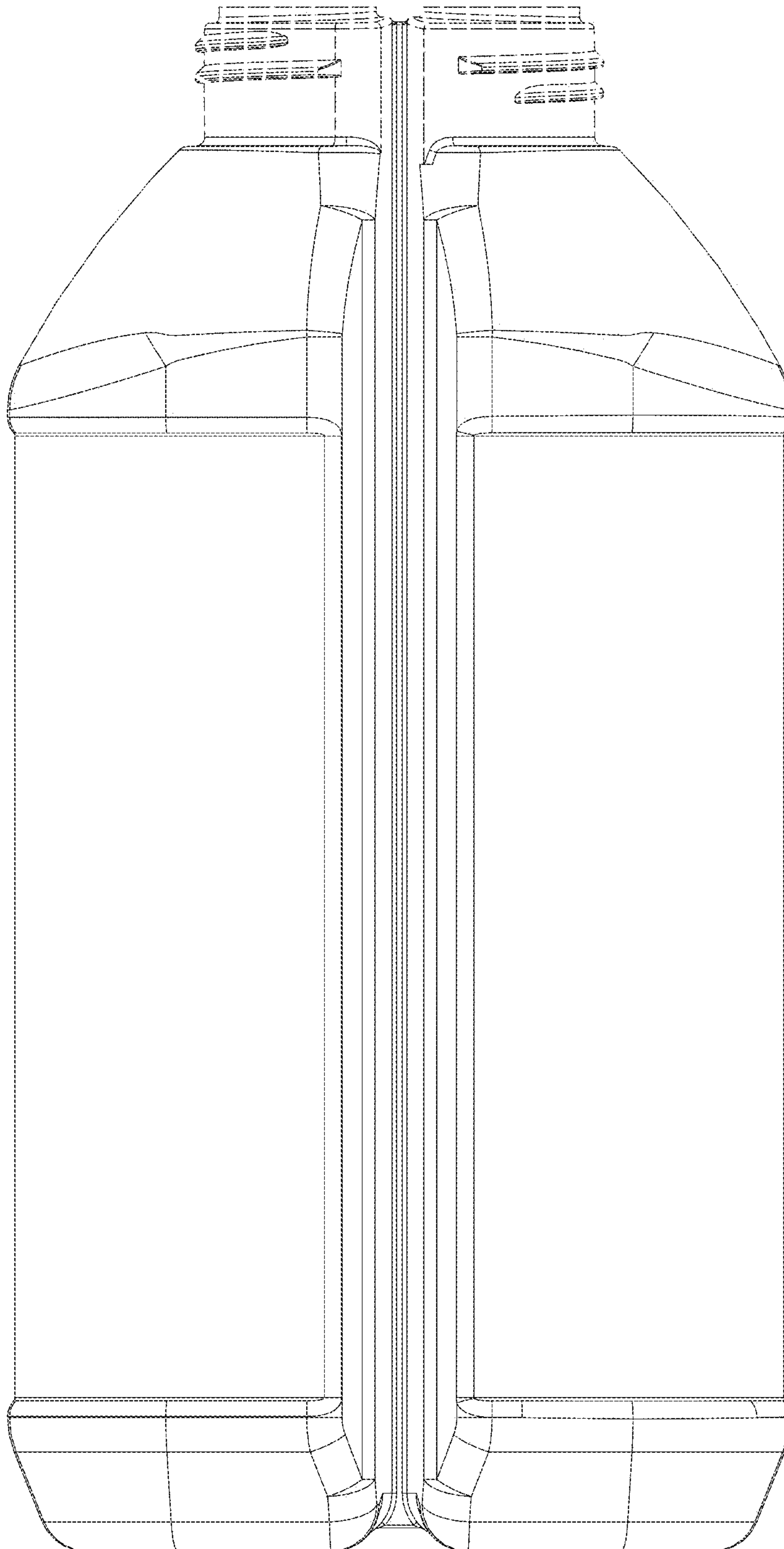

FIG. 4

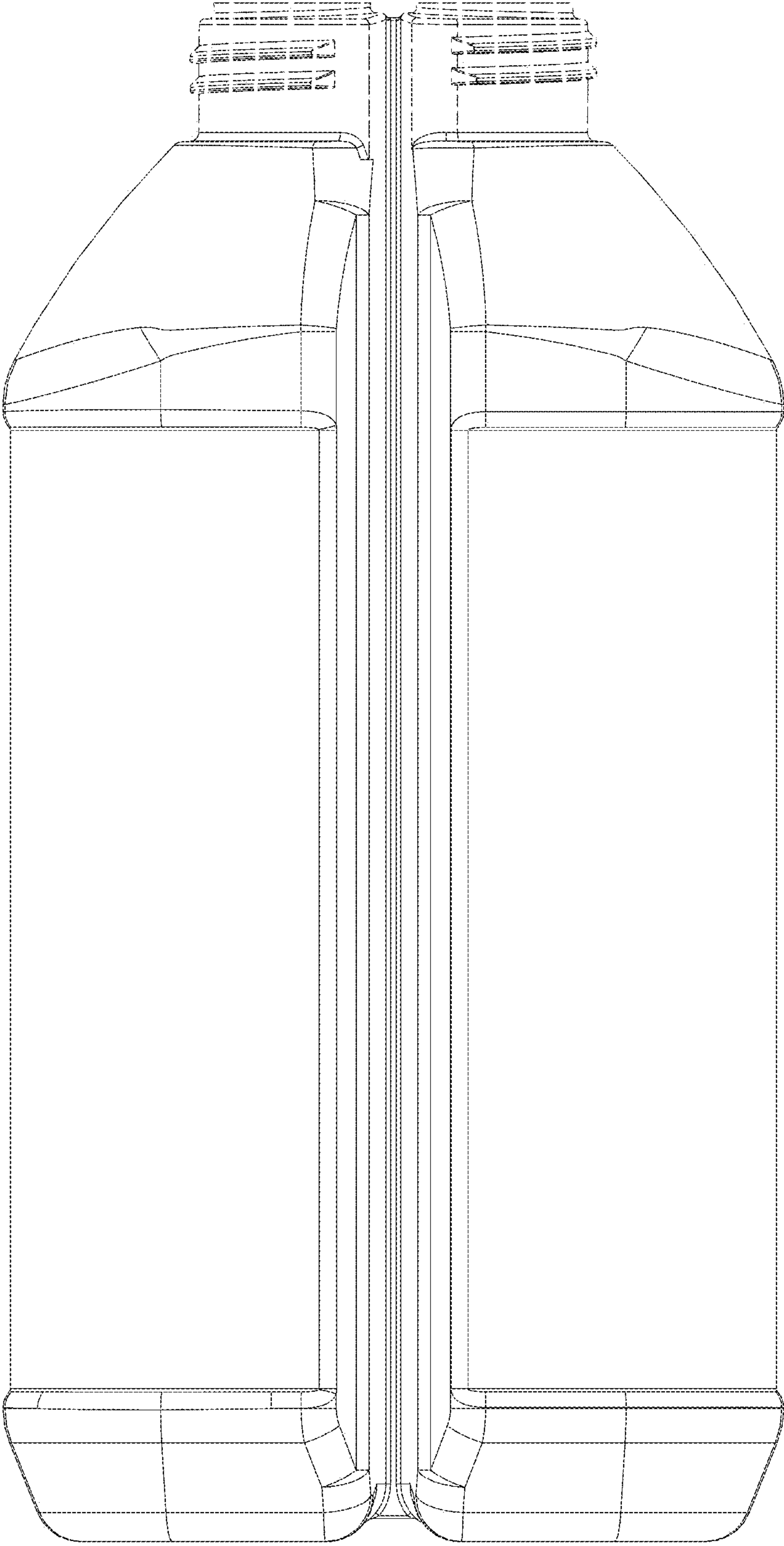

FIG. 5

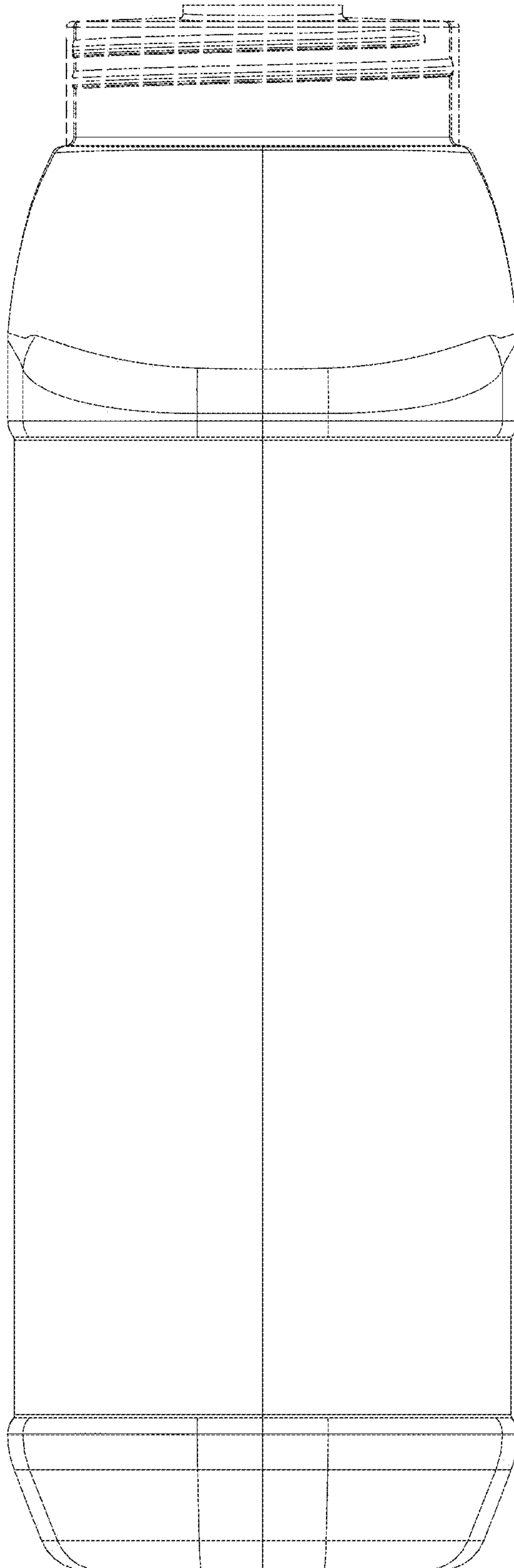

FIG. 6

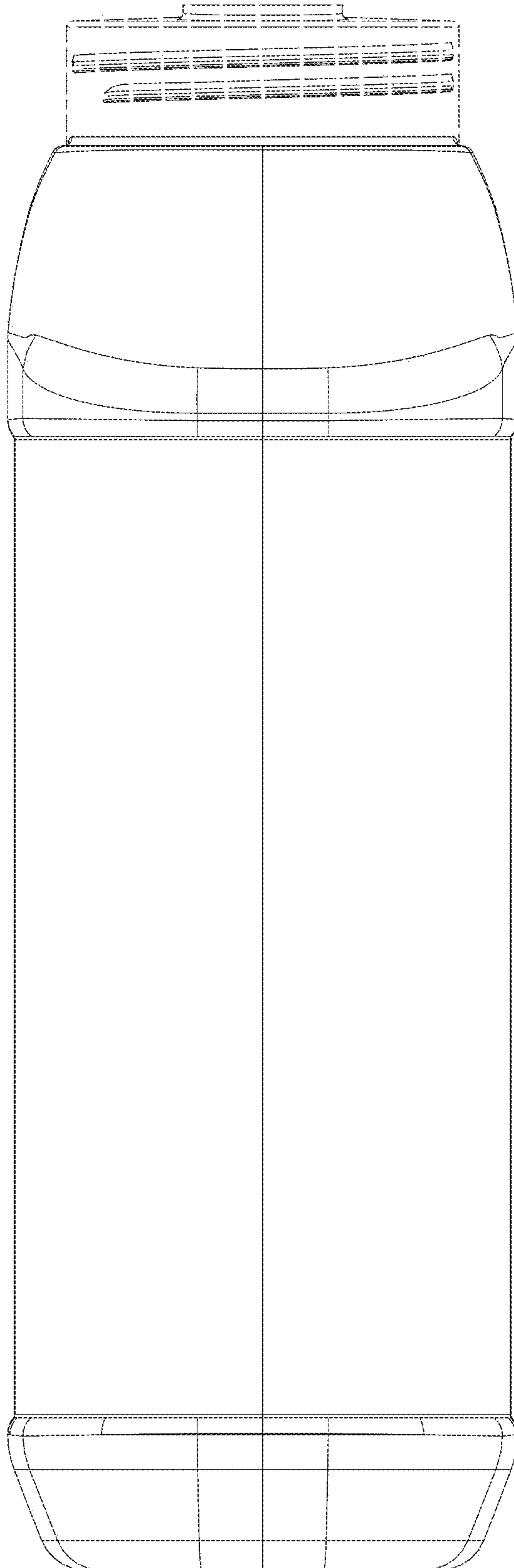



FIG. 7

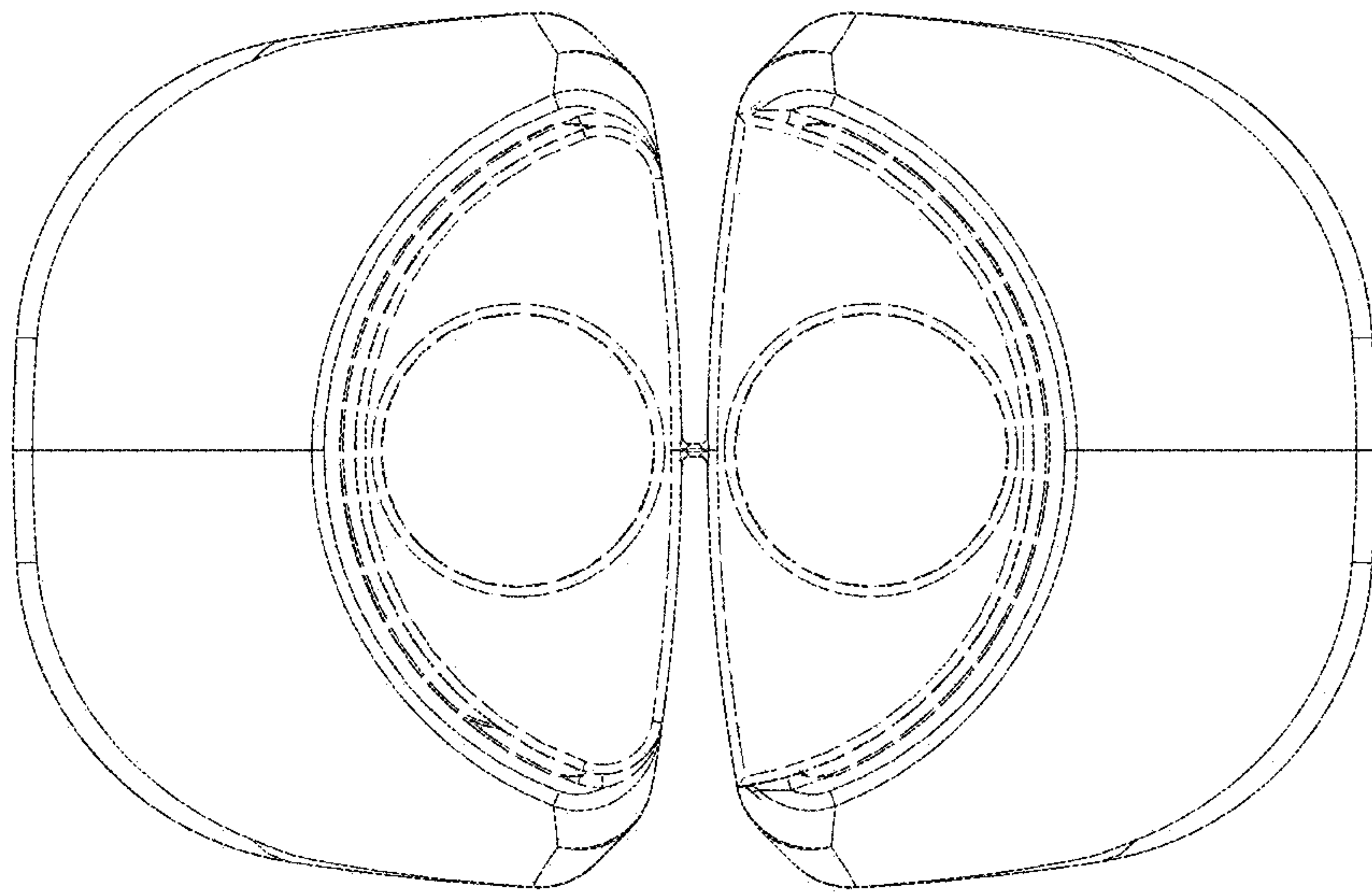

FIG. 8

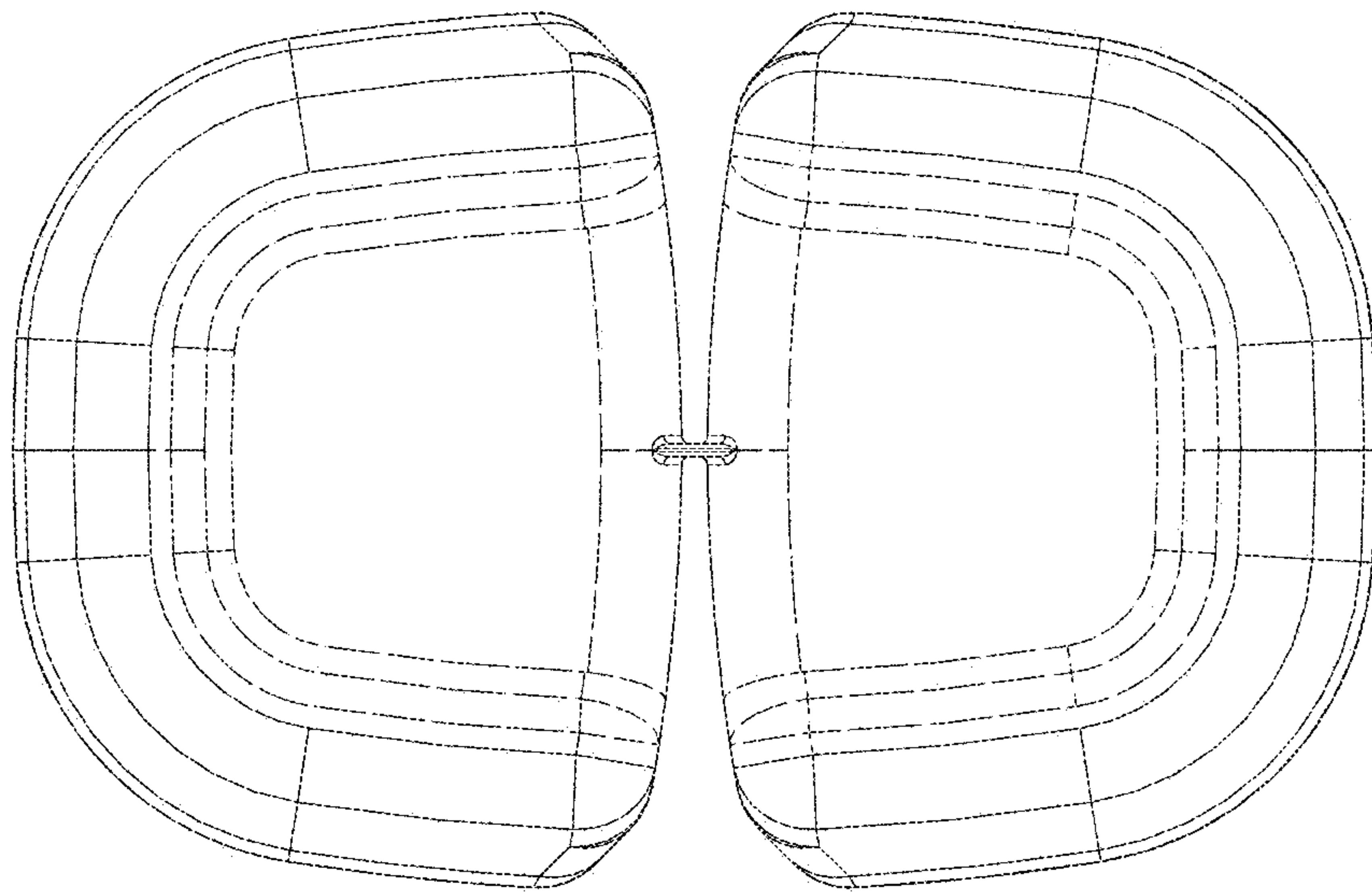

FIG. 9

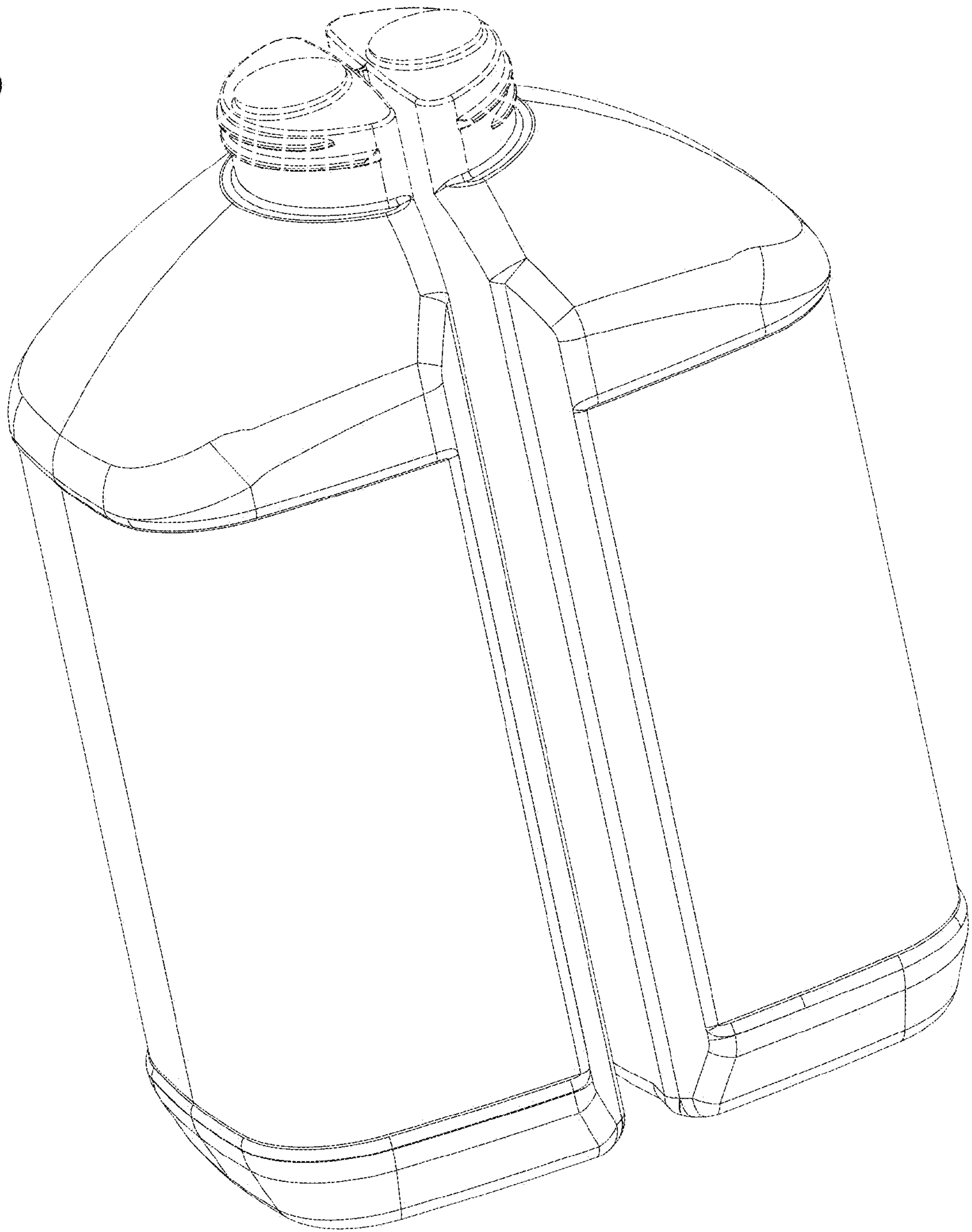

FIG. 10

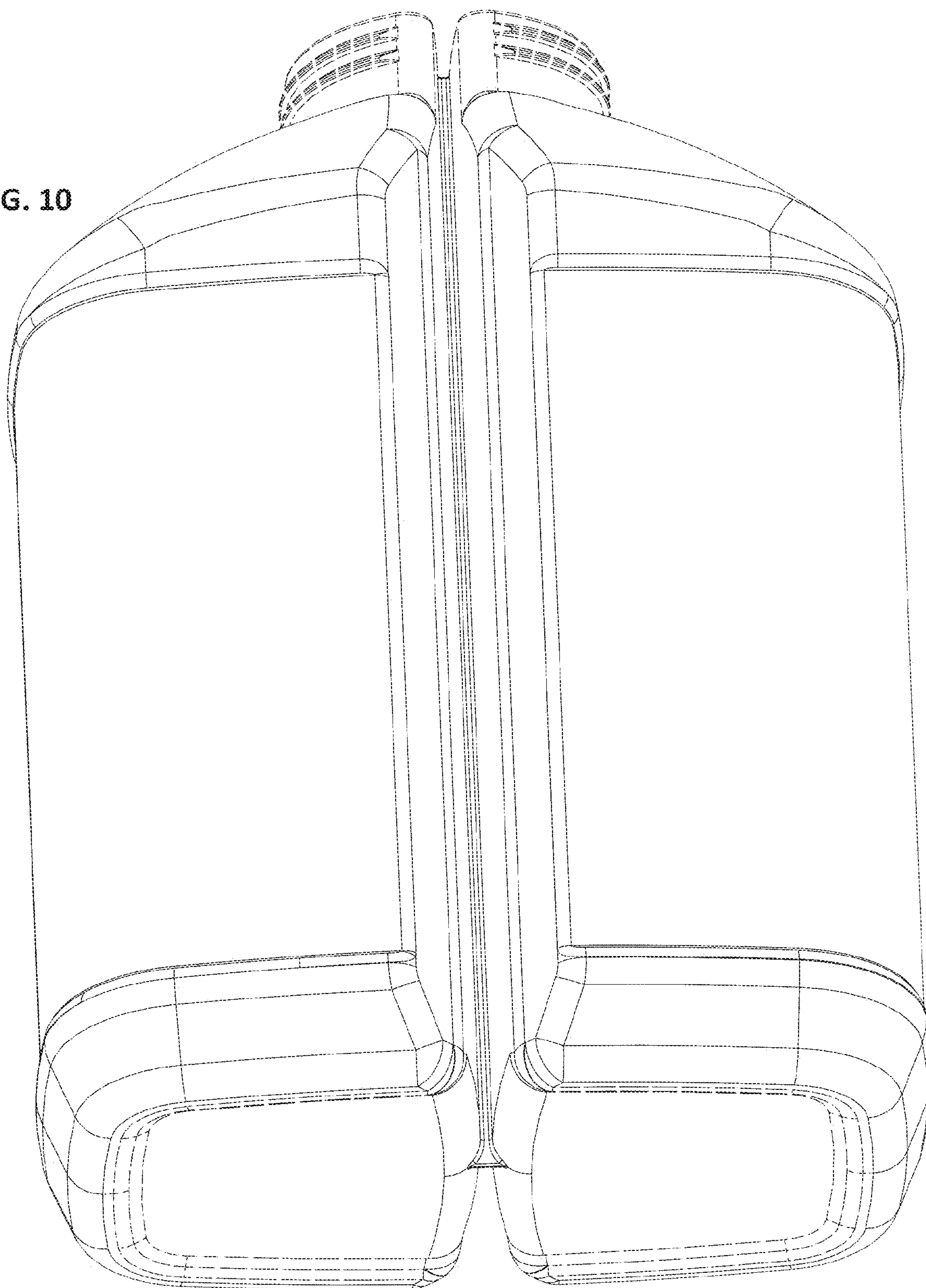

FIG. 11

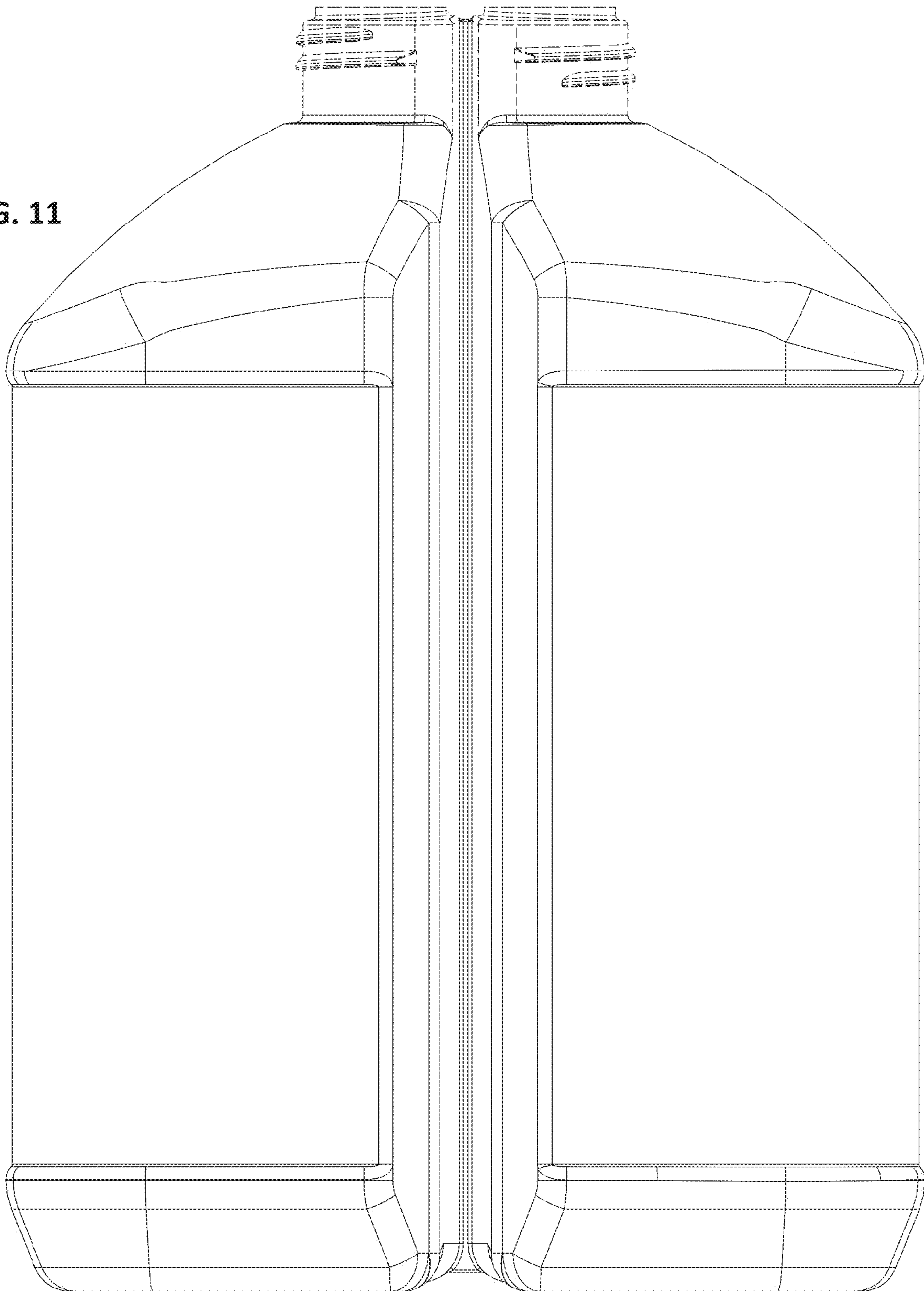



FIG. 12

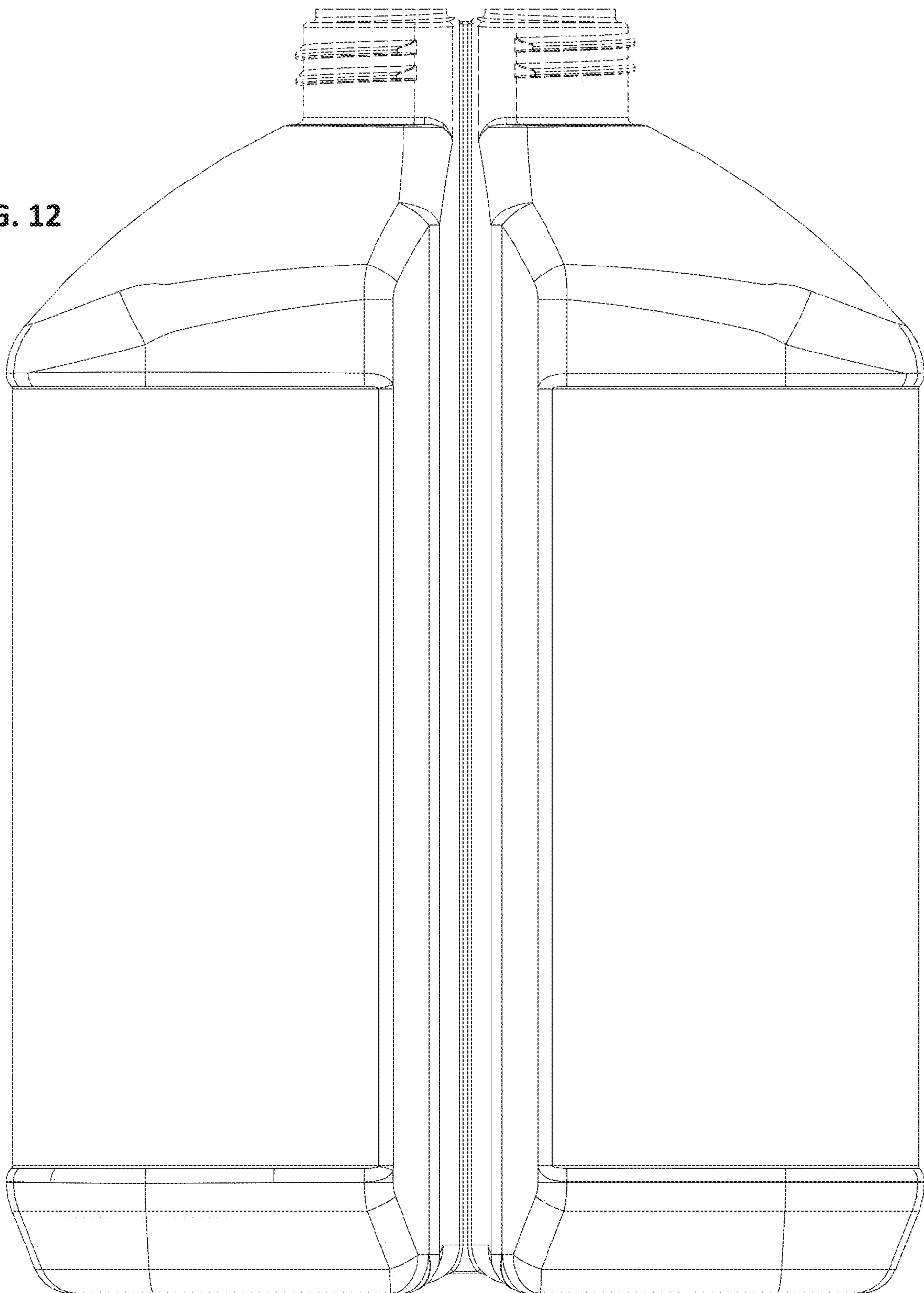

FIG. 13

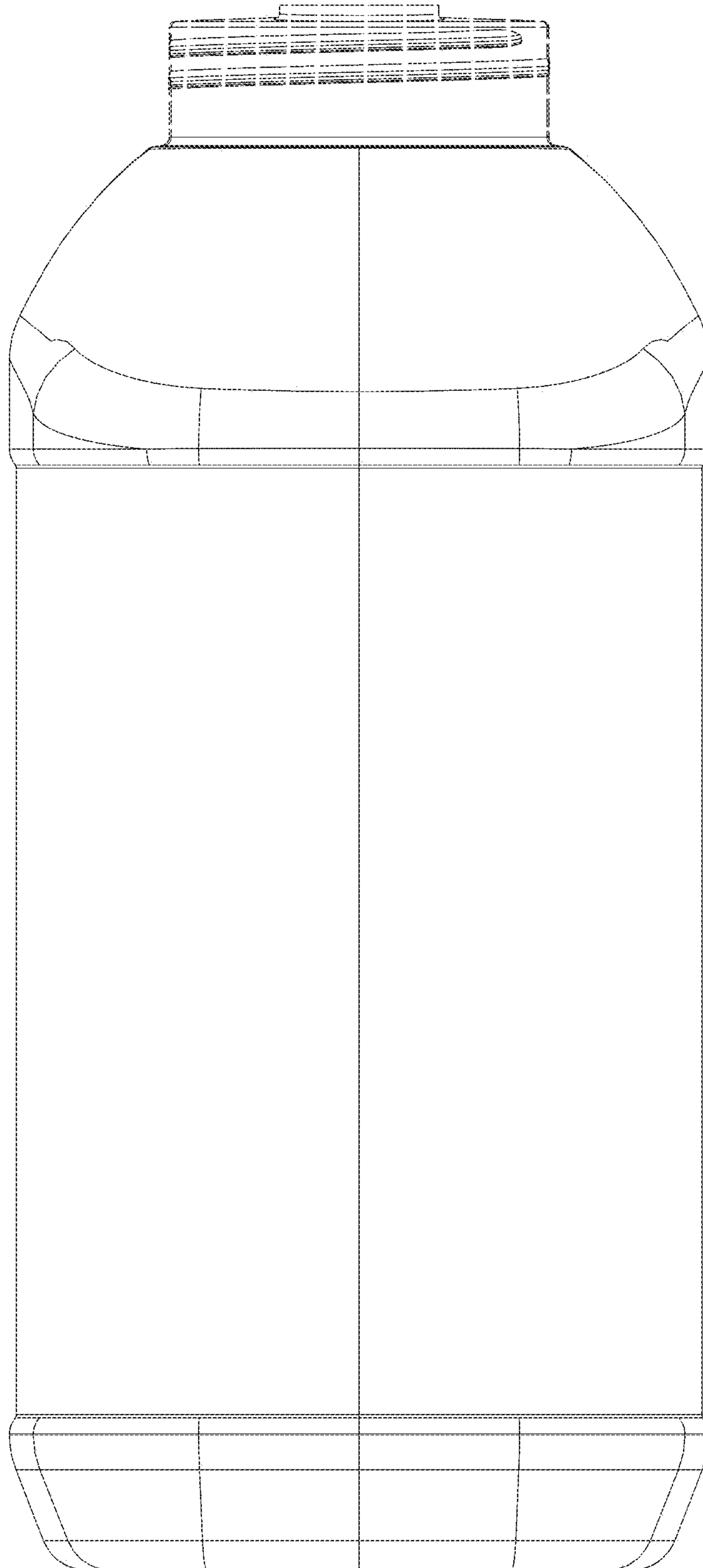

FIG. 14

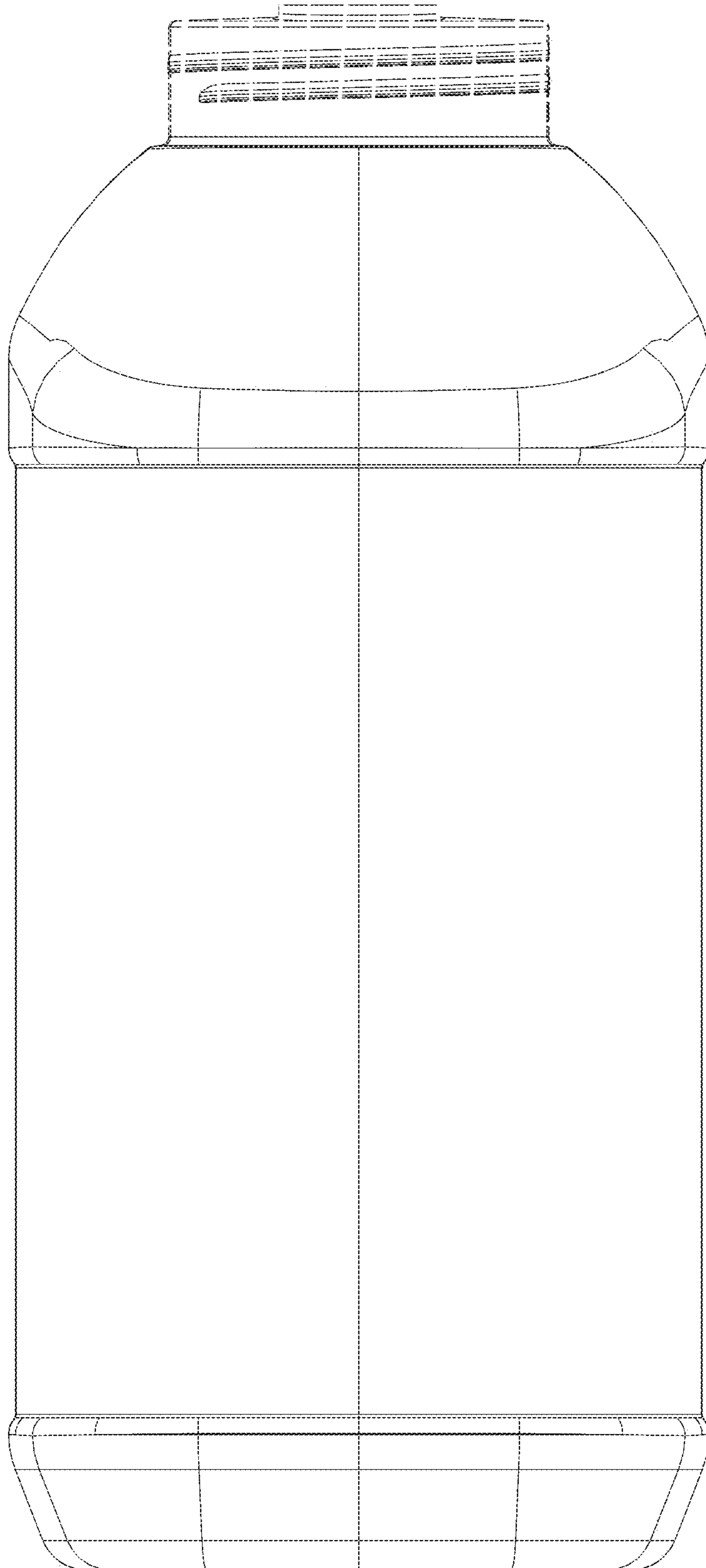

FIG. 15

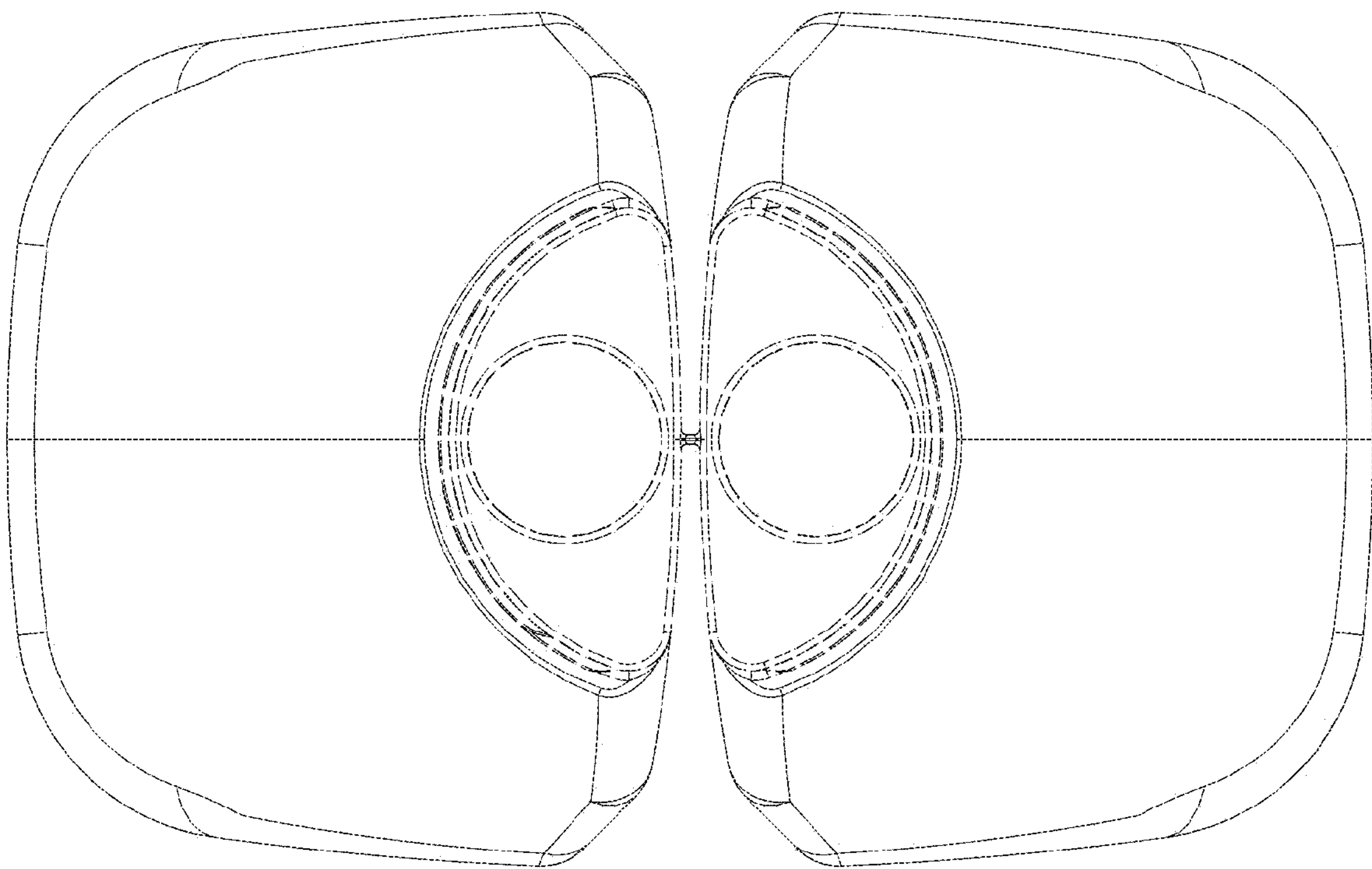

FIG. 16

