

US00D957246S

(12) **United States Design Patent** (10) **Patent No.:** **US D957,246 S**  
**Culler et al.** (45) **Date of Patent:** **\*\* Jul. 12, 2022**

- (54) **COLLECTION CONTAINER** 4,583,681 A \* 4/1986 Neese ..... B65D 5/46024  
 229/117.22  
 (71) Applicant: **Persephone Biosciences, Inc.**, San Diego, CA (US) D384,583 S \* 10/1997 Green ..... D9/431  
 D490,703 S \* 6/2004 Rusnock ..... D9/416  
 D494,061 S \* 8/2004 Brown ..... D9/415  
 D589,346 S \* 3/2009 Hall ..... D9/432  
 (72) Inventors: **Stephanie June Culler**, Del Mar, CA (US); **Shaun Adam Singer**, Del Mar, CA (US); **Kristian Luis Jerman**, Hallendale Beach, FL (US) D655,614 S \* 3/2012 De Baschmakoff ..... D9/600  
 D782,298 S \* 3/2017 de Baschmakoff ..... D9/432  
 10,435,196 B2 \* 10/2019 Uematsu ..... B65D 5/0227  
 D876,219 S \* 2/2020 Martin ..... D9/432

\* cited by examiner

(73) Assignee: **PERSEPHONE BIOSCIENCES, INC.**, San Diego, CA (US)

*Primary Examiner* — Rhea Shields

(\*\*) Term: **15 Years**

(74) *Attorney, Agent, or Firm* — Greer, Burns & Crain, Ltd

(21) Appl. No.: **29/789,538**

(57) **CLAIM**

(22) Filed: **Sep. 29, 2021**

The ornamental design for a collection container, as shown and described.

**Related U.S. Application Data**

**DESCRIPTION**

(62) Division of application No. 29/681,955, filed on Feb. 28, 2019.

(51) **LOC (13) Cl.** ..... **09-03**

(52) **U.S. Cl.**  
USPC ..... **D9/420**

(58) **Field of Classification Search**  
USPC ..... D9/420, 444, 414–419, 431–432, 668,  
D9/600; D3/297, 284; D14/440  
CPC ..... B65D 5/0227; B65D 5/46024; B65D  
5/46192

See application file for complete search history.

FIG. 1 is a top front perspective view of an embodiment of the present collection container showing our new design; FIG. 2 is a front elevational view thereof; FIG. 3 is a rear elevational view thereof; FIG. 4 is a first side elevational view of same; FIG. 5 is an opposite side elevational view thereof; FIG. 6 is a top plan view thereof; FIG. 7 is a bottom plan view thereof; FIG. 8 is a first side top front perspective view thereof, with a lid thereof in an open position; and, FIG. 9 is a second side top front perspective view thereof, with the lid thereof in an open position.

In the drawings, the evenly spaced broken lines are for the purpose of illustrating portions of the collection container that form no part of the claimed design.

(56) **References Cited**

**U.S. PATENT DOCUMENTS**

- 2,795,367 A \* 6/1957 Feldman ..... B65D 5/46192  
 229/117.12  
 D266,226 S \* 9/1982 Zdarsky ..... D9/418

**1 Claim, 7 Drawing Sheets**

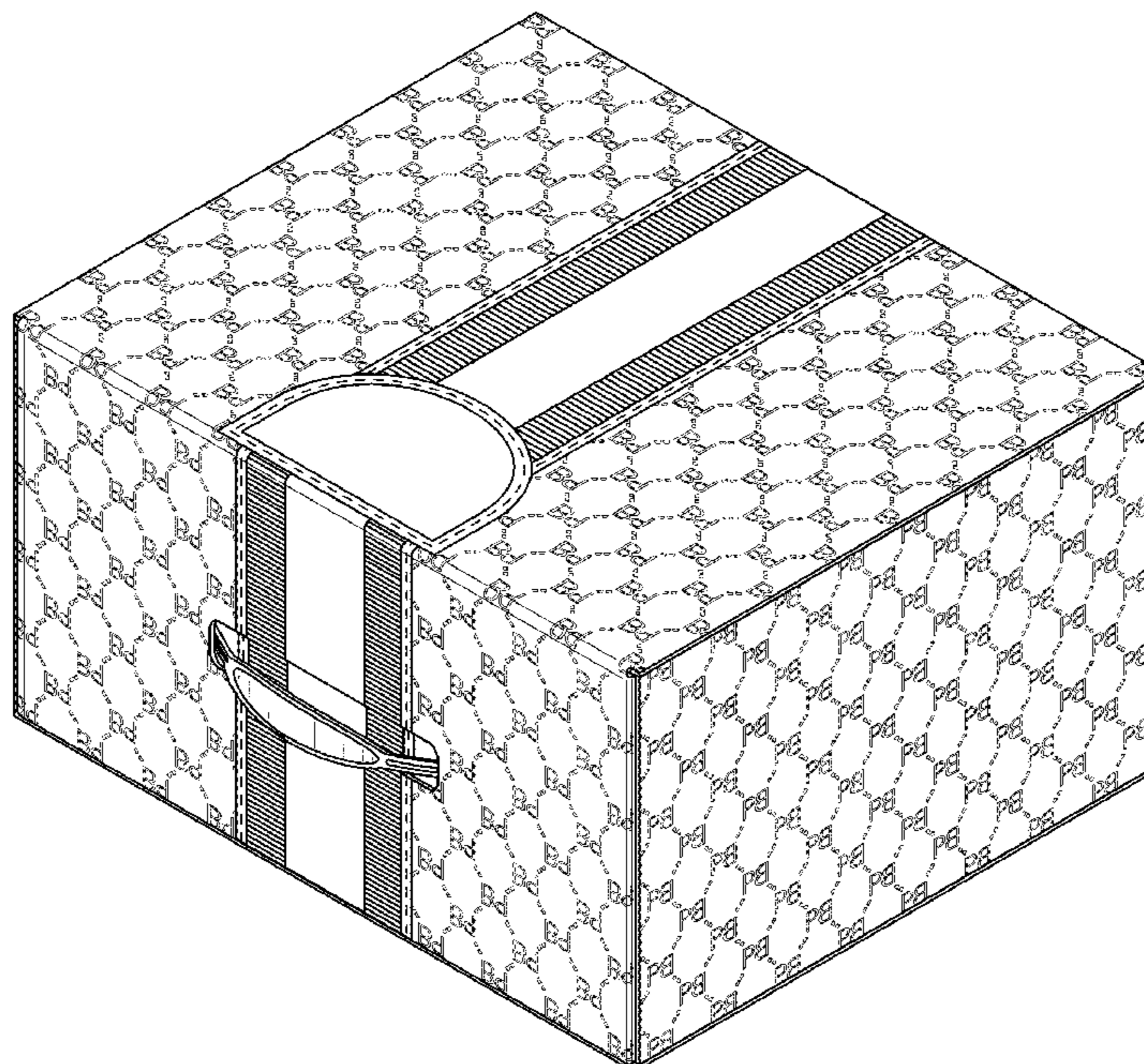



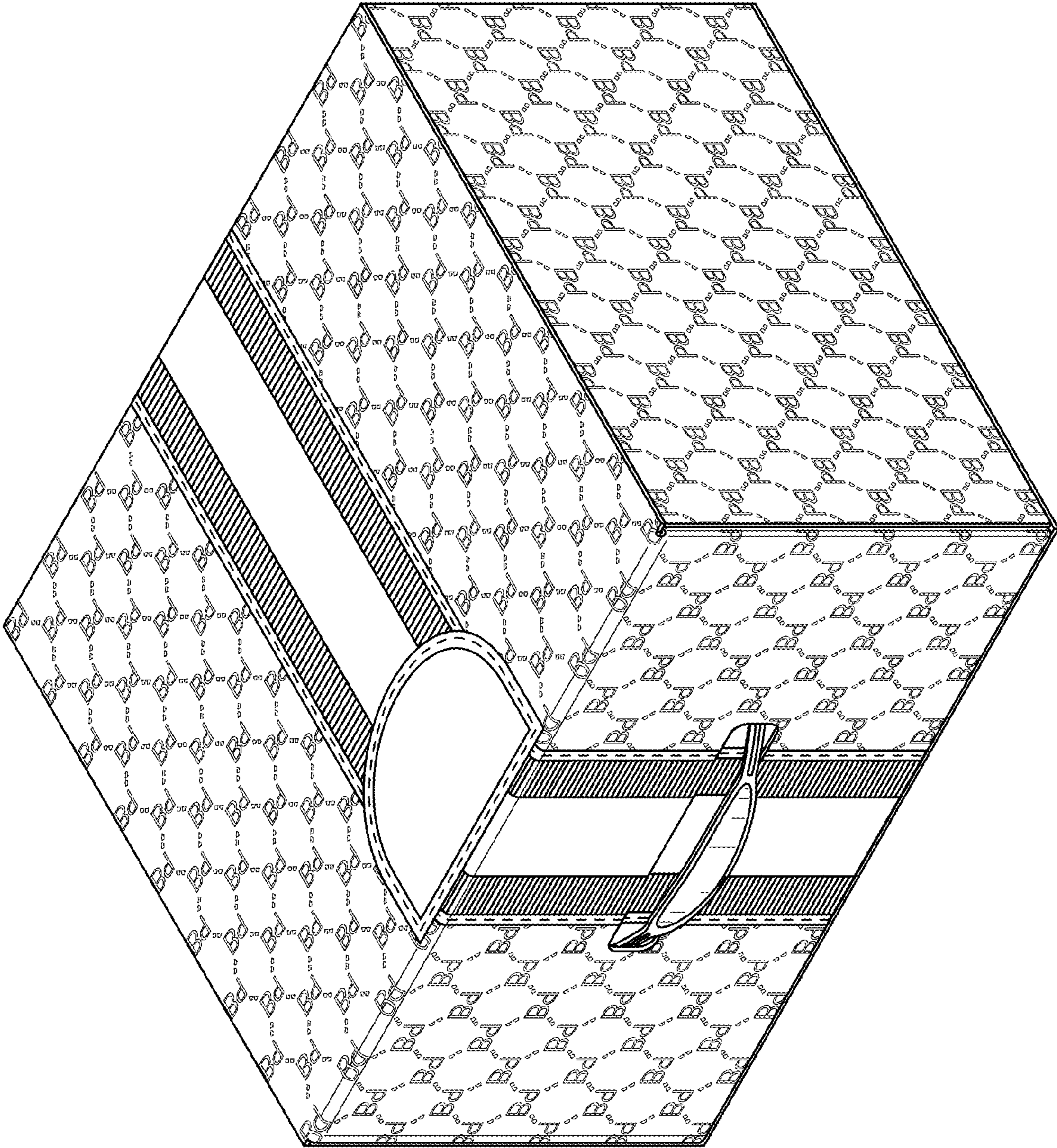

FIG. 1



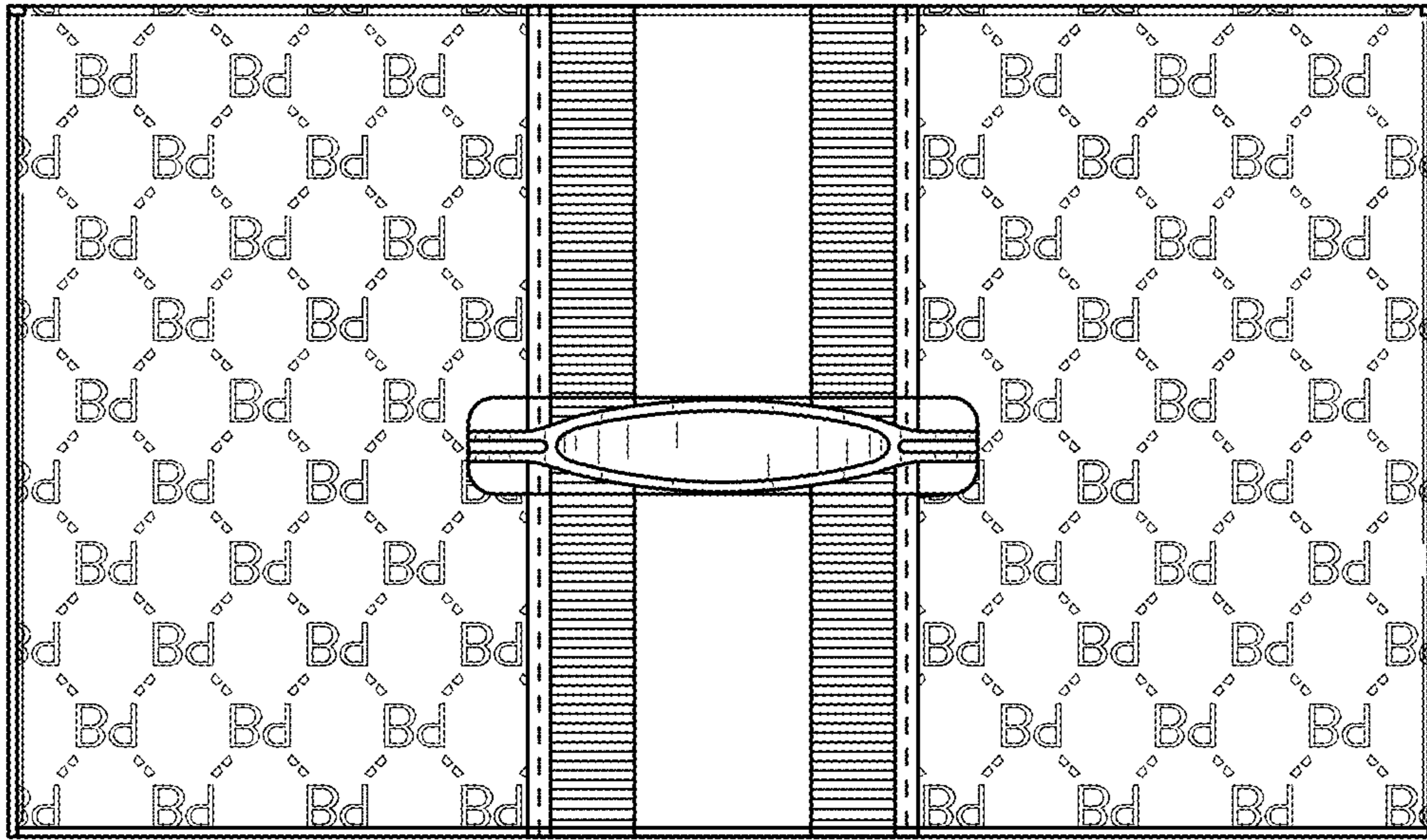

FIG. 2

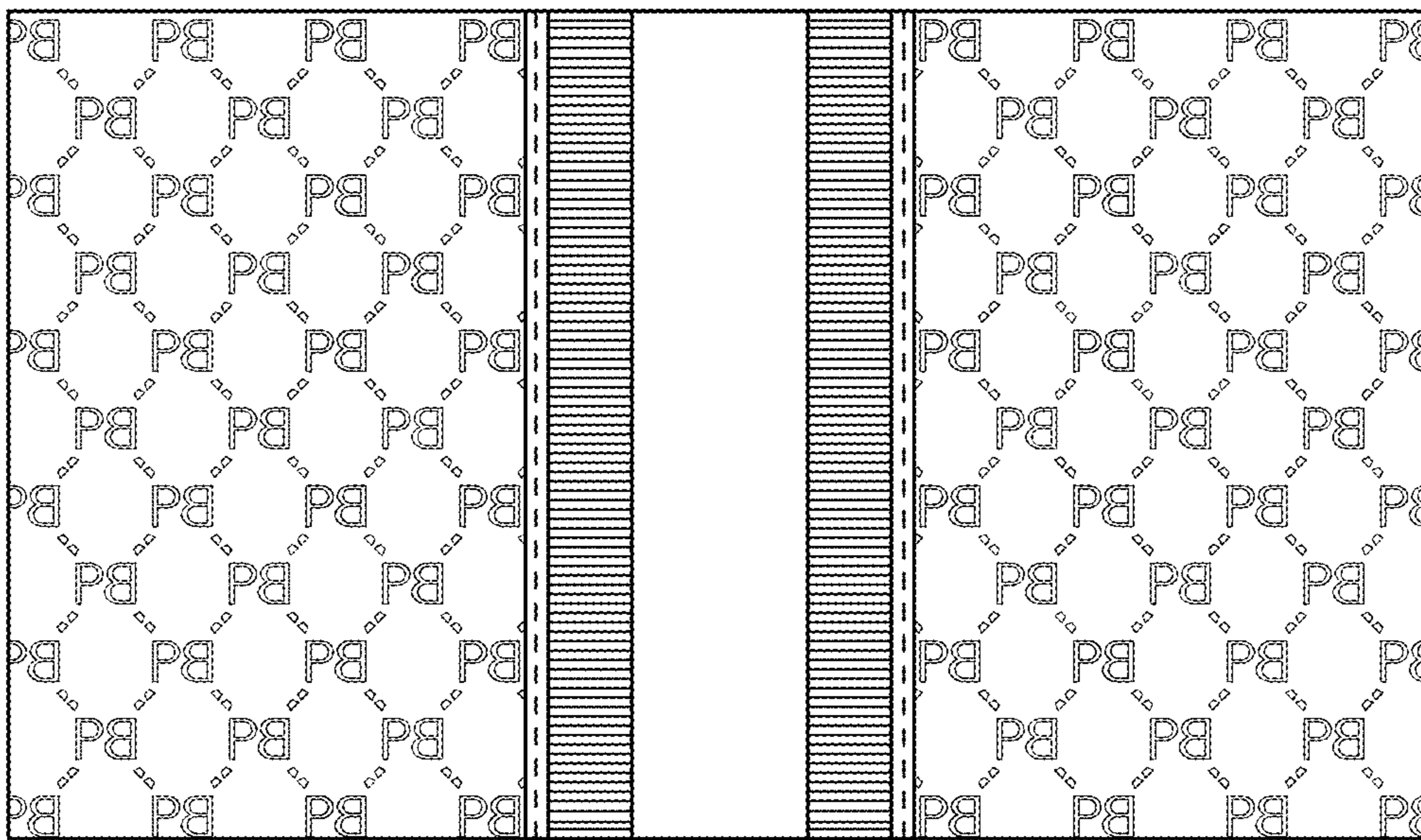

FIG. 3

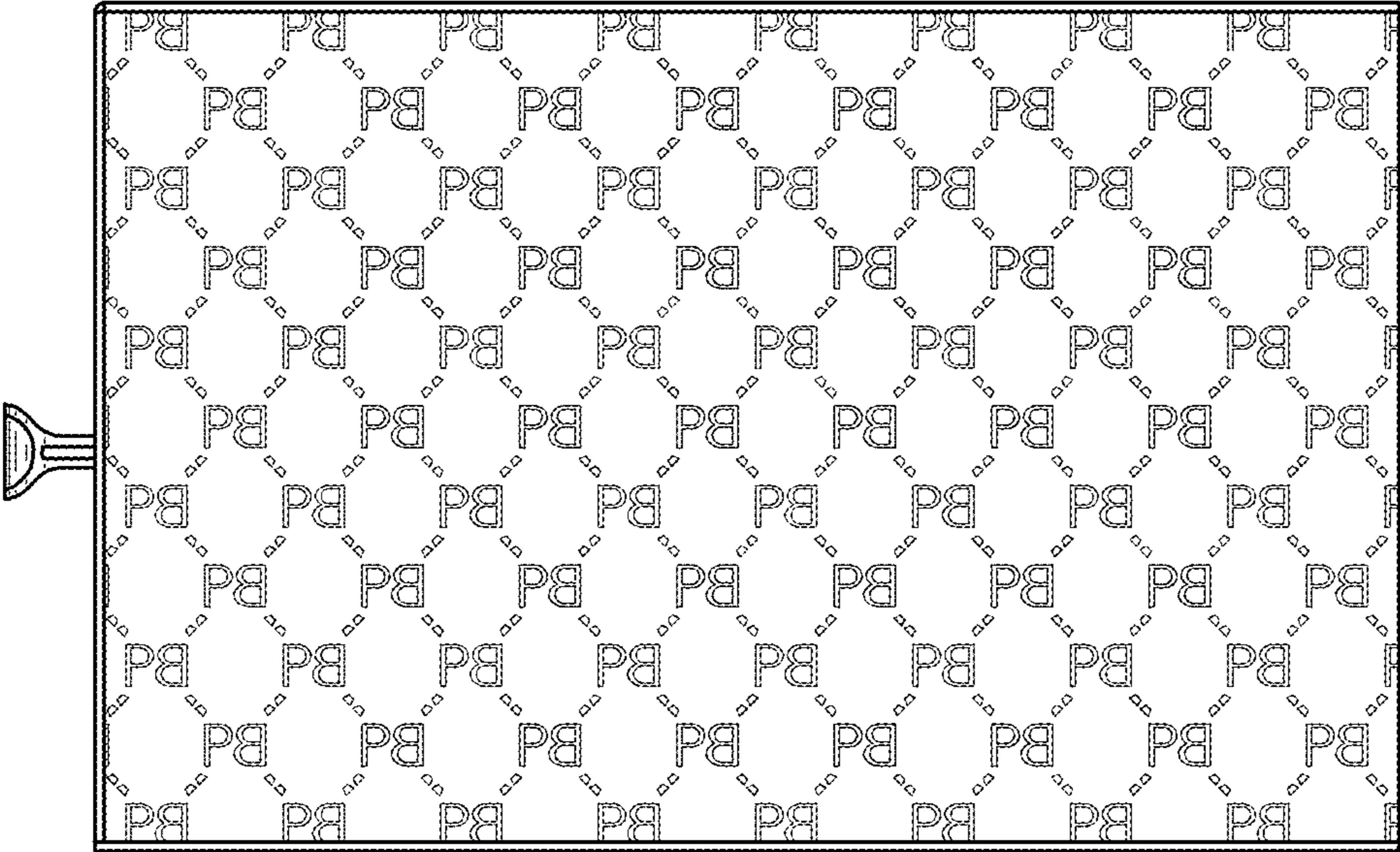

FIG. 4

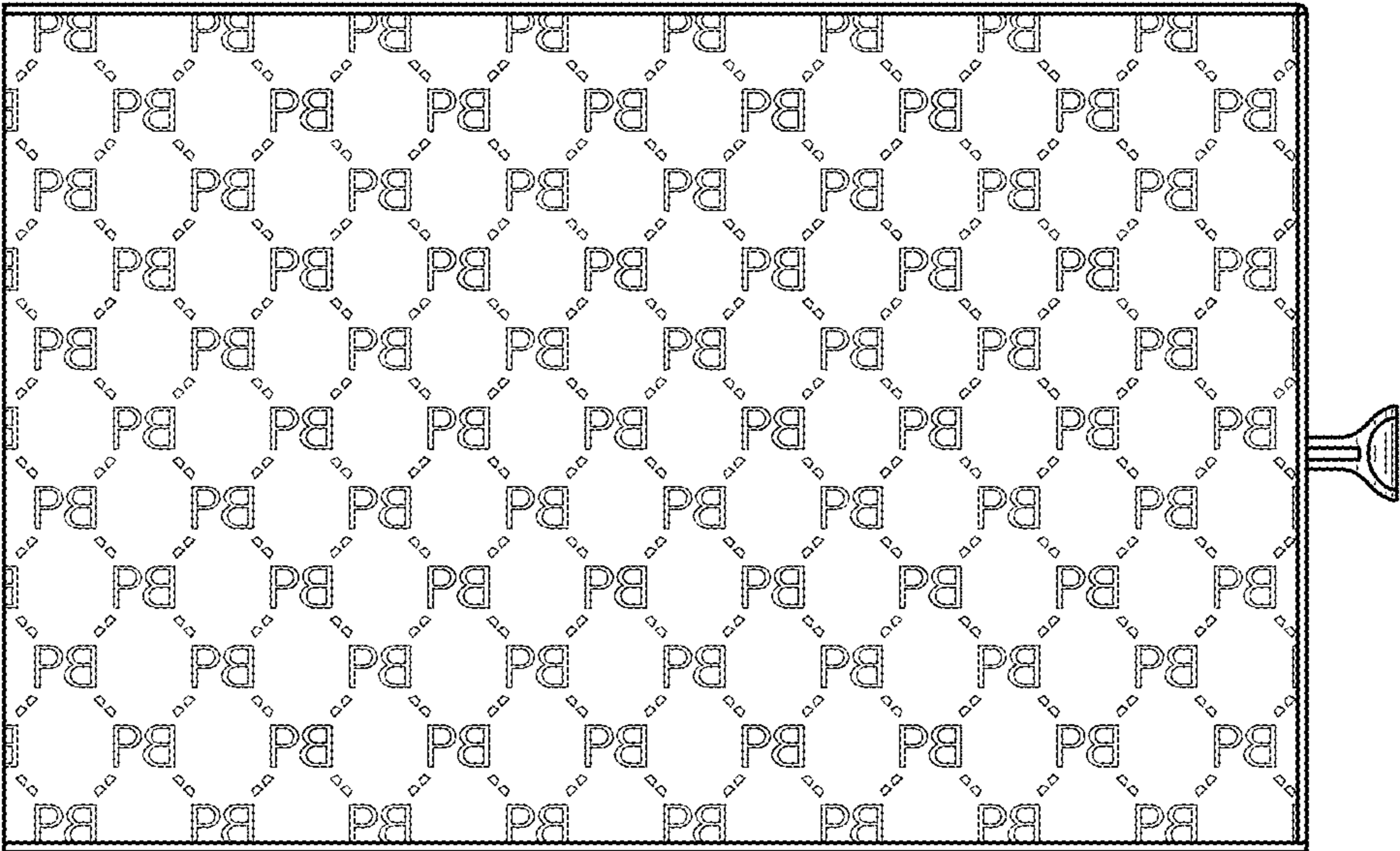

FIG. 5



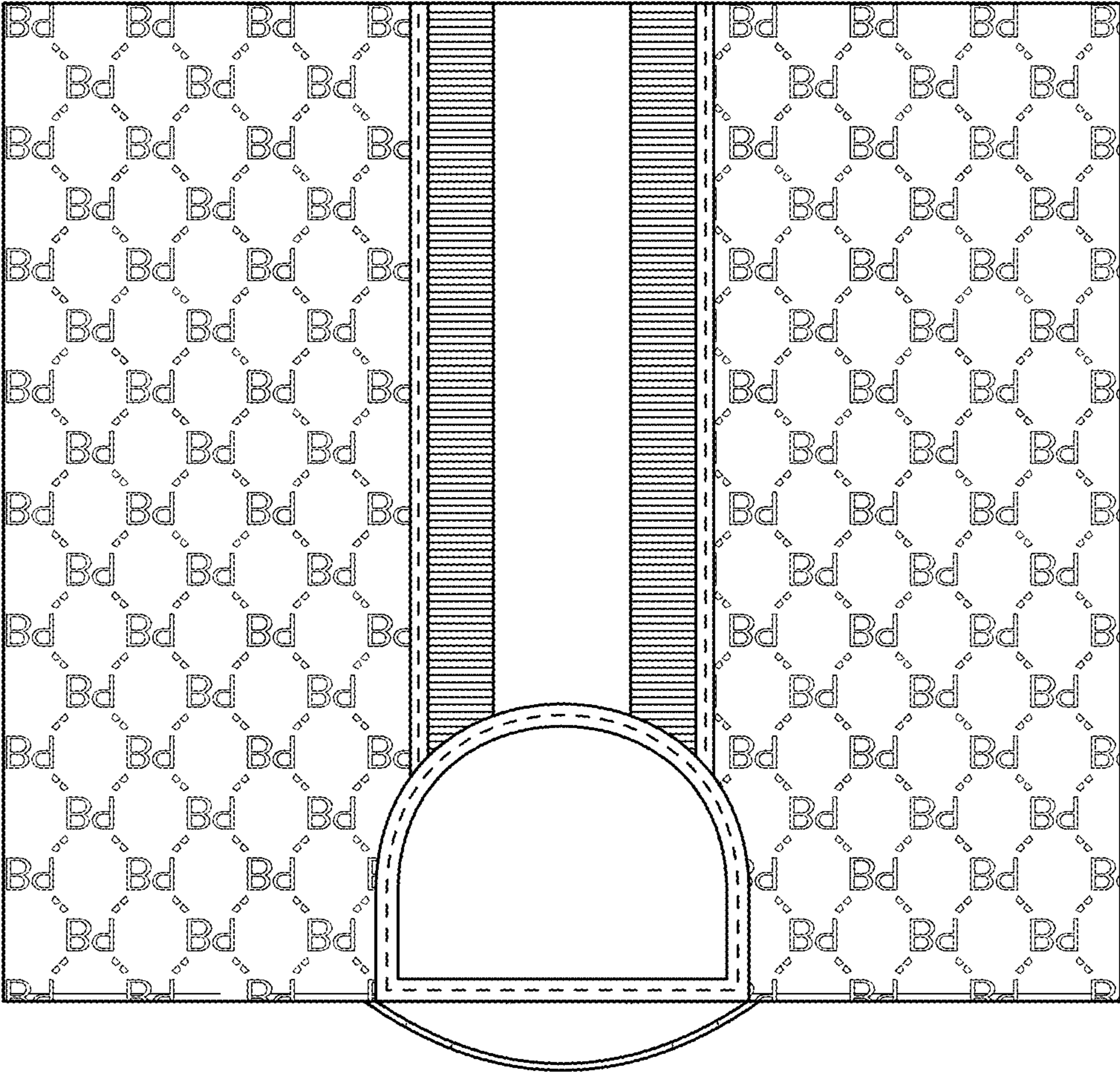

FIG. 6

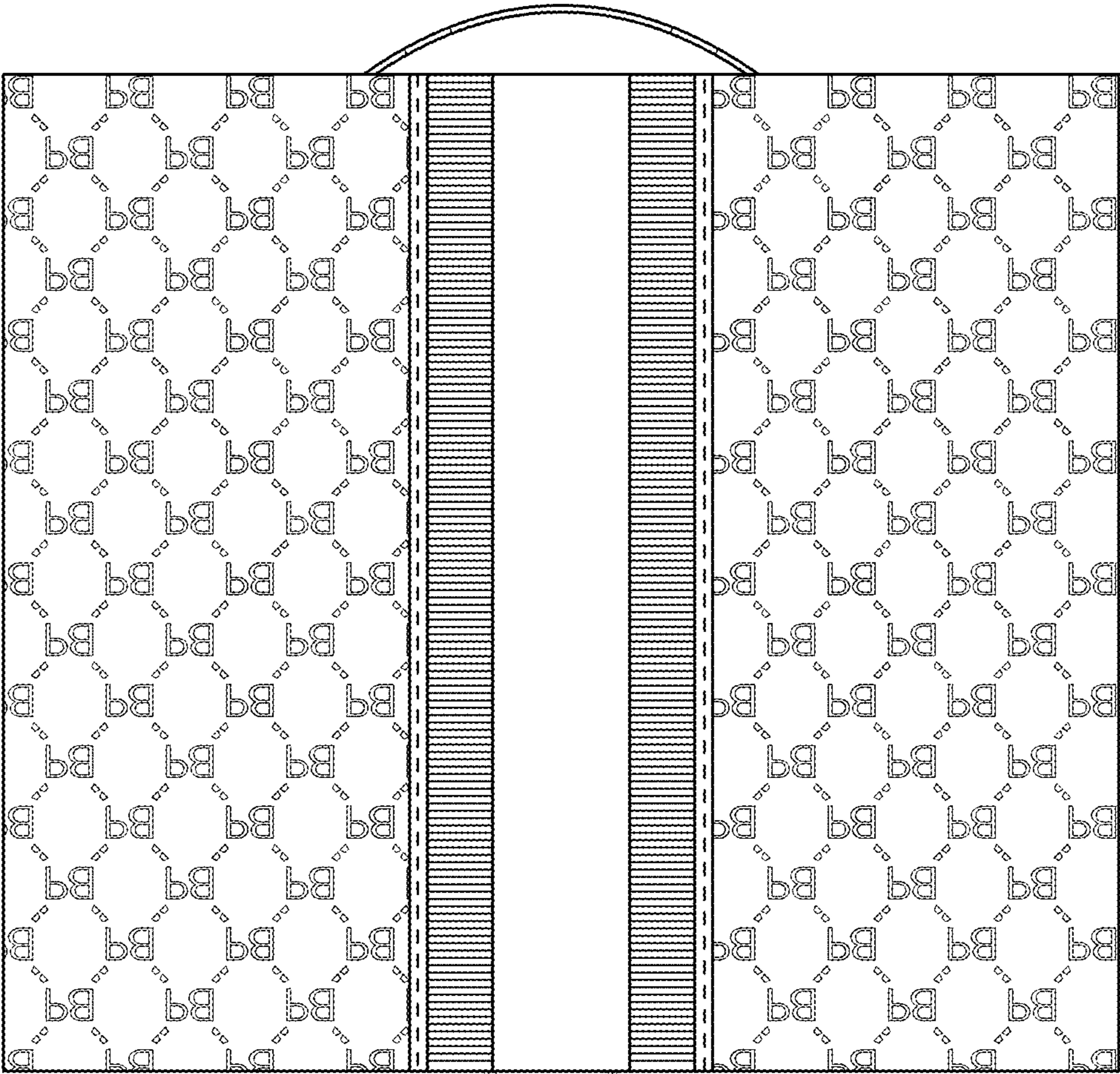

FIG. 7



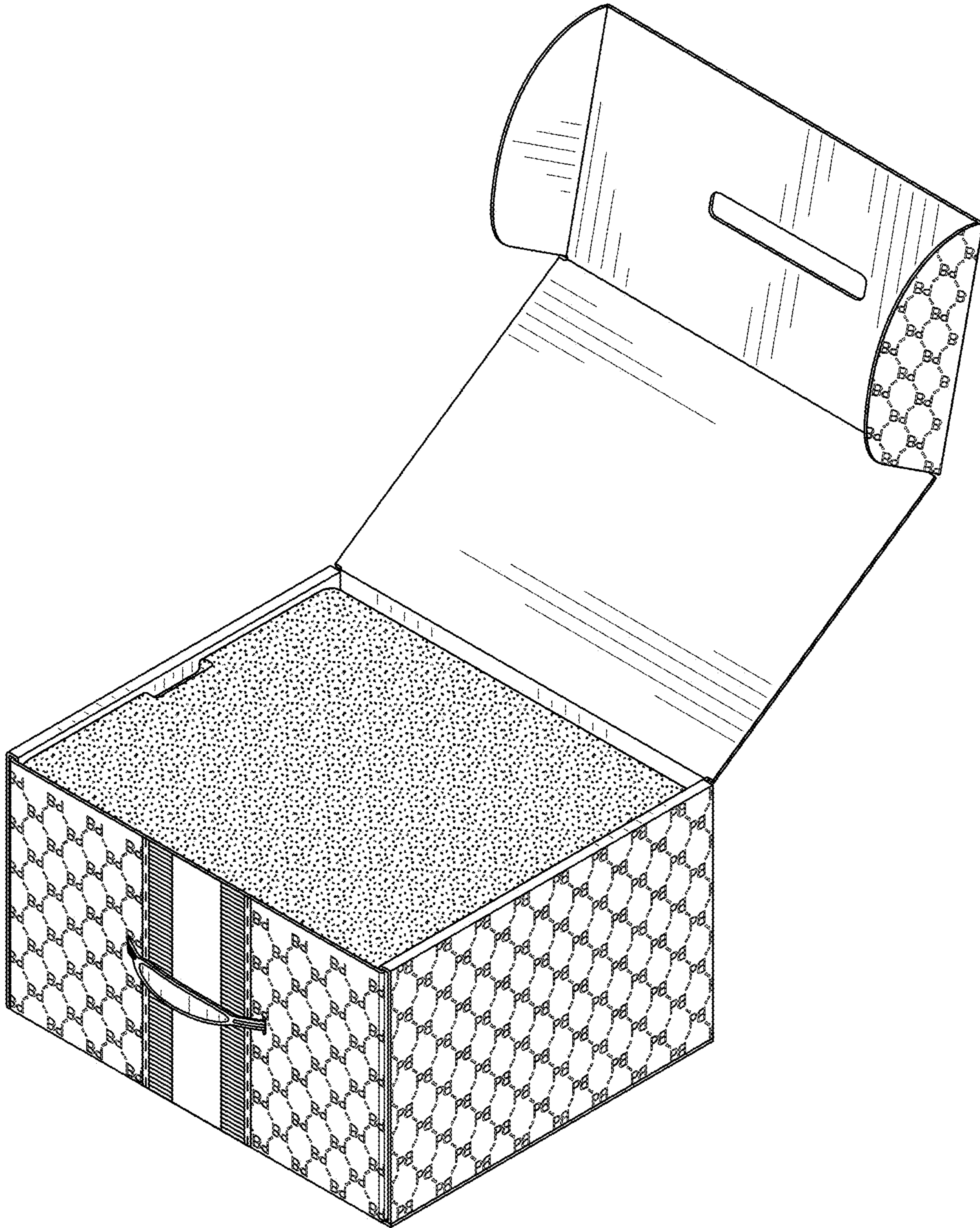

FIG. 8

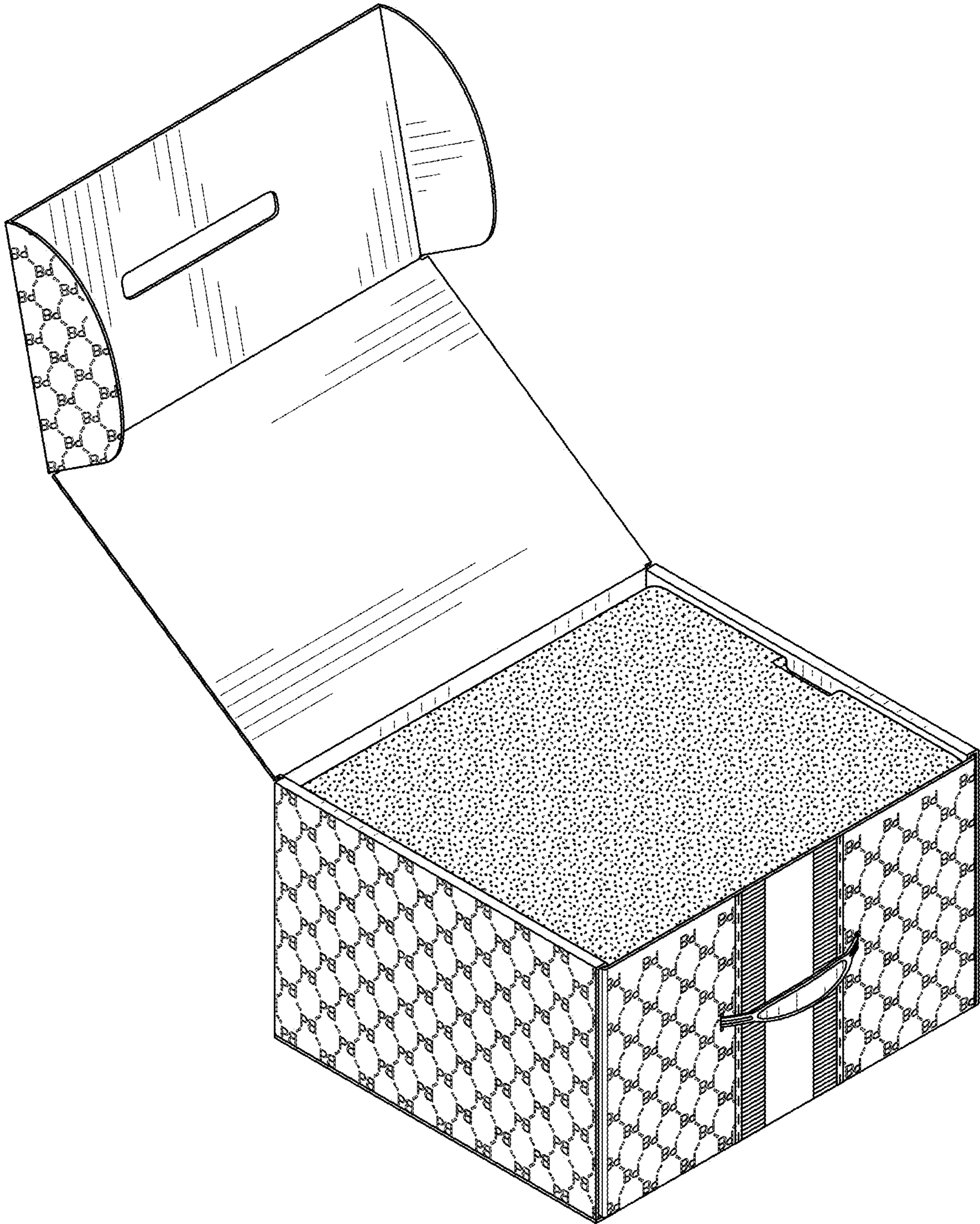

FIG. 9