



US00D957136S

(12) **United States Design Patent**
Gooden et al.

(10) **Patent No.:** **US D957,136 S**
(45) **Date of Patent:** **** Jul. 12, 2022**

- (54) **FLOOR MAT BRUSHING CAP**
- (71) Applicant: **Hopkins Manufacturing Corporation**, Emporia, KS (US)
- (72) Inventors: **Marcus Gooden**, LomaLinda, CA (US); **Pieter Schouten**, Berkley, CA (US); **James R. Kingsbury**, Lakewood, CA (US)
- (73) Assignee: **Hopkins Manufacturing Corporation**, Emporia, KS (US)
- (**) Term: **15 Years**

D417,961 S *	12/1999	Powis, Jr.	D4/127
D457,327 S *	5/2002	Liu	D4/115
D510,863 S *	10/2005	Juhng	D9/436
D532,979 S *	12/2006	Viola	D4/129
D609,014 S *	2/2010	Hill	D4/114
D619,373 S *	7/2010	Tani	D4/114
D654,792 S *	2/2012	Bertelsen	D9/436
D702,949 S *	4/2014	Dunivan	D4/114
9,078,514 B2 *	7/2015	Nalbandian	A46B 9/02
D787,830 S *	5/2017	Jack	D4/116
D787,831 S *	5/2017	Jack	D4/116
D814,729 S *	4/2018	Gooden	D32/52
D845,001 S *	4/2019	Jack	D4/130
D858,019 S *	8/2019	Gooden	D32/45
D858,020 S *	8/2019	Gooden	D32/45

(Continued)

- (21) Appl. No.: **29/731,477**
- (22) Filed: **Apr. 15, 2020**
- (51) **LOC (13) Cl.** **04-01**
- (52) **U.S. Cl.**
USPC **D4/114; D9/448; D32/45**
- (58) **Field of Classification Search**
USPC D4/114, 115, 116, 121, 127, 128, 130, D4/131, 132, 133, 134, 135, 136, 137, D4/199; D9/436, 448; D32/45
CPC A46B 9/023; A46B 11/0017; B25G 3/02; A45D 34/042
See application file for complete search history.

FOREIGN PATENT DOCUMENTS

- KR 300922022.0000 * 9/2017
Primary Examiner — Karen E Eldridge Powers
(74) *Attorney, Agent, or Firm* — Bond Schoeneck & King, PLLC; George McGuire

(57) **CLAIM**

The ornamental design for a floor mat brushing cap, as shown and described.

DESCRIPTION

FIG. 1 is a perspective view of a floor mat brushing cap; FIG. 2 is a front elevation view thereof; FIG. 3 is a rear elevation view thereof; FIG. 4 is a first side elevation view thereof; FIG. 5 is a second and opposite side elevation view thereof; FIG. 6 is a top plan view thereof; and, FIG. 7 is a bottom plan view thereof. Features of the floor mat brushing cap shown in broken lines in the drawings illustrate environmental structure and form no part of the claimed design.

1 Claim, 6 Drawing Sheets

(56) **References Cited**
U.S. PATENT DOCUMENTS

D92,088 S *	4/1934	Johnson	D4/114
D196,707 S *	10/1963	Anderson	D4/114
3,387,911 A *	6/1968	Focht	B65D 83/205 401/190
D218,958 S *	10/1970	Tompkins	D4/114
D226,462 S *	3/1973	Gibbs	D4/114
D281,123 S *	10/1985	Frassanito	D4/114
D295,921 S *	5/1988	Spadotto	D4/115
4,974,984 A *	12/1990	Kafkis	A45D 34/042 401/186

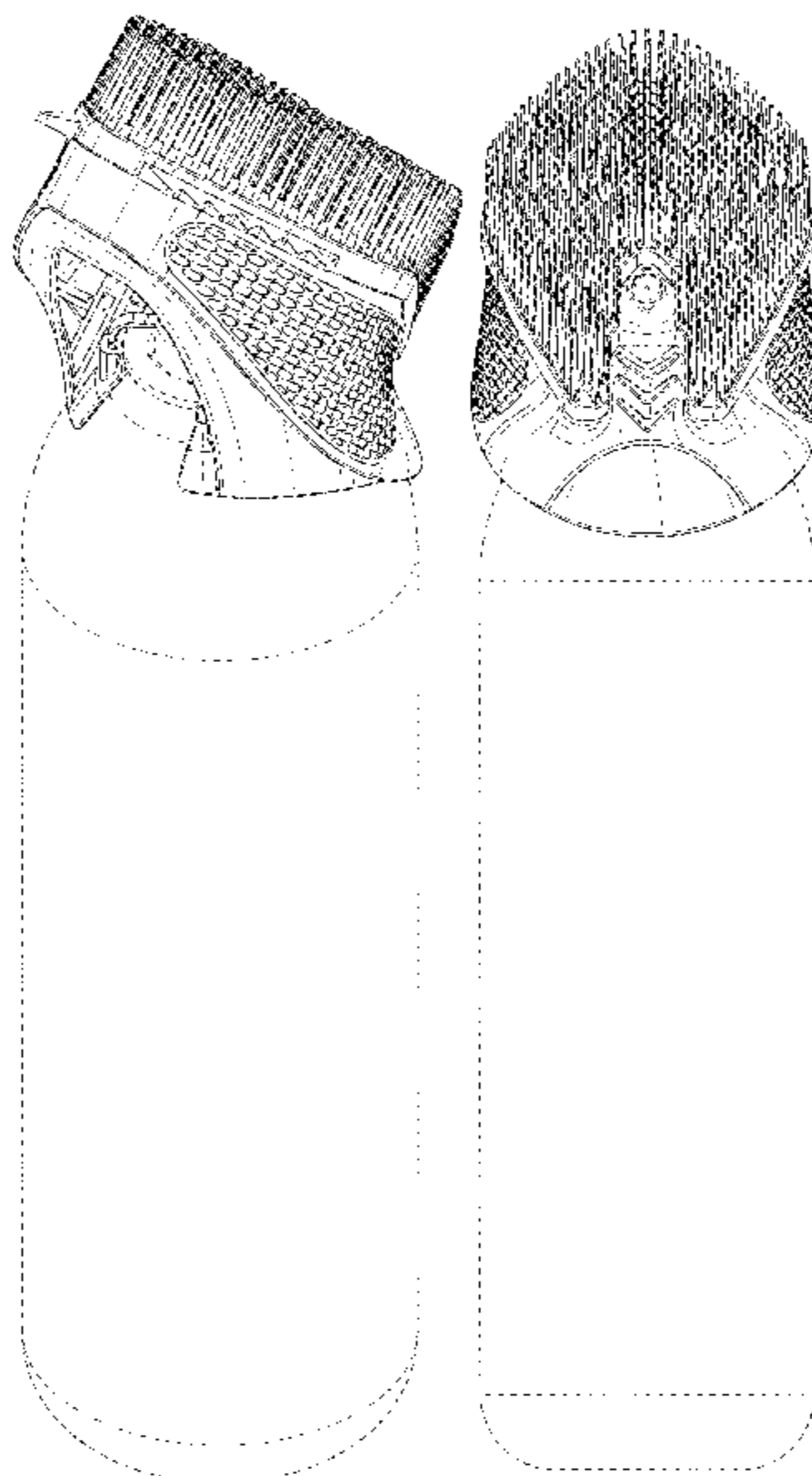

(56)

References Cited

U.S. PATENT DOCUMENTS

D873,149 S * 1/2020 Gooden D9/685
D886,464 S * 6/2020 Wisnewski D4/135

* cited by examiner

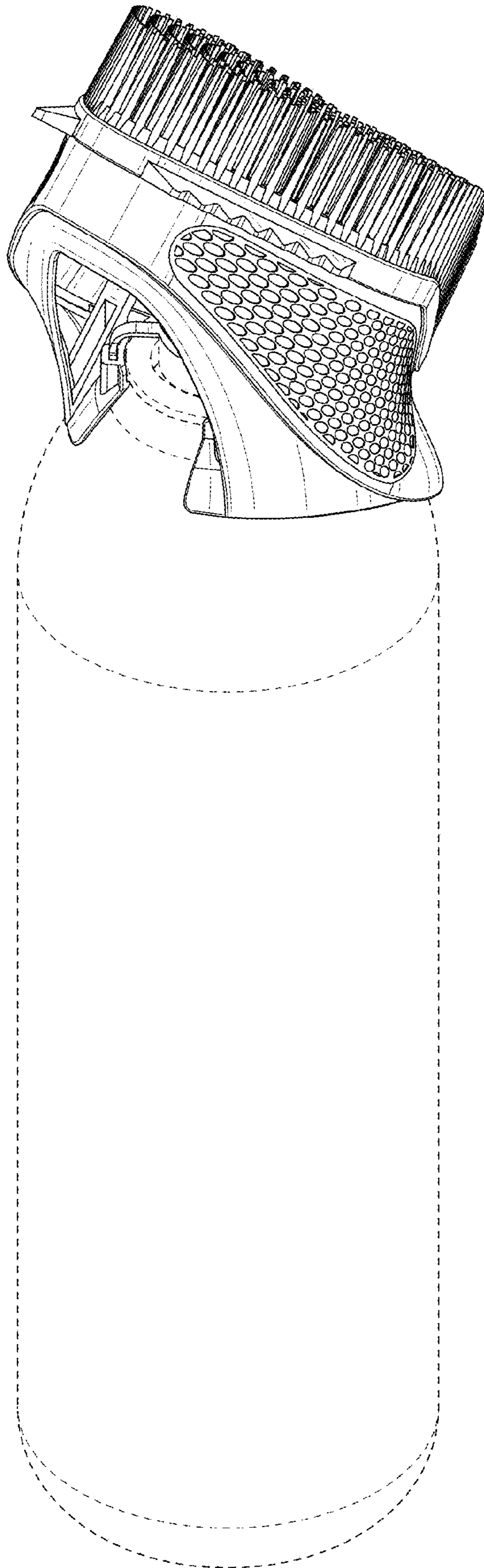

FIG. 1

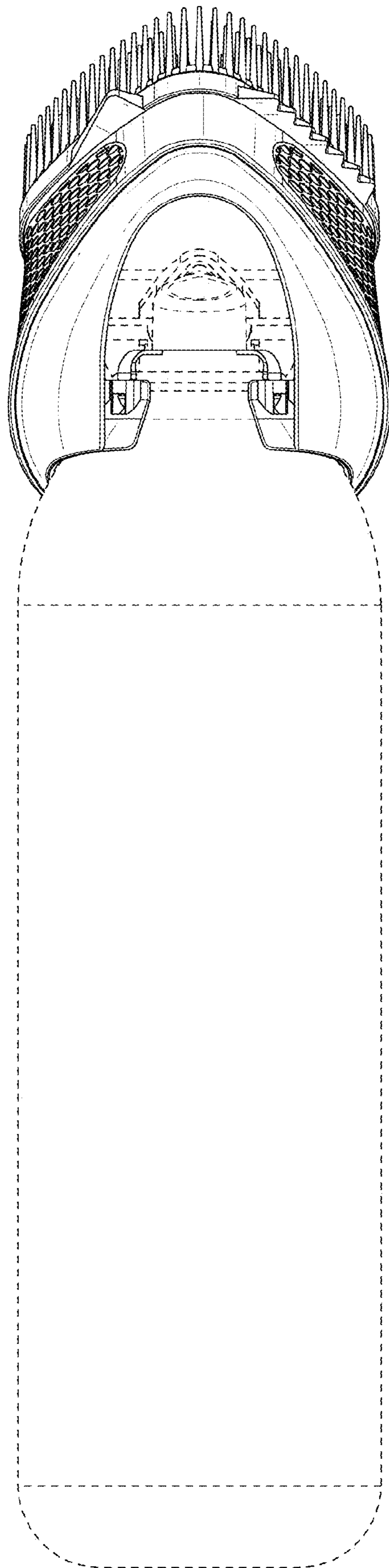

FIG. 2

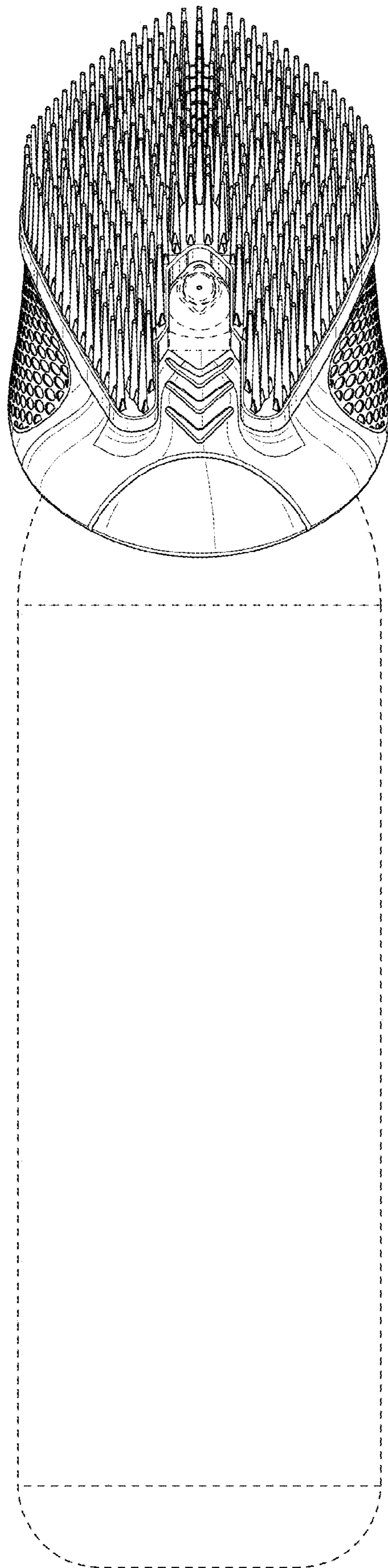

FIG. 3

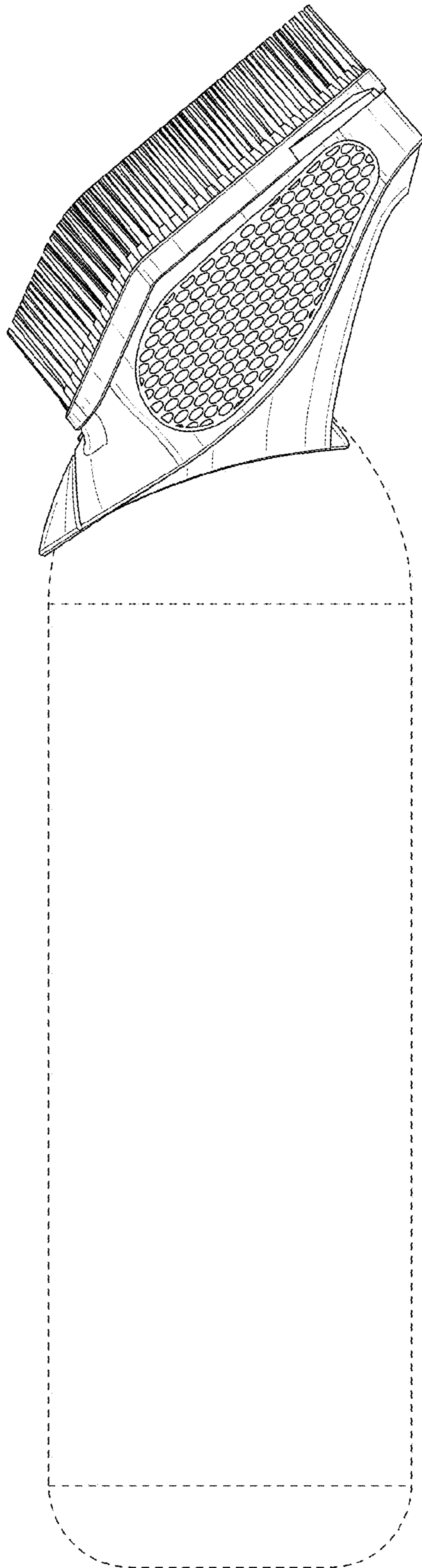

FIG. 4

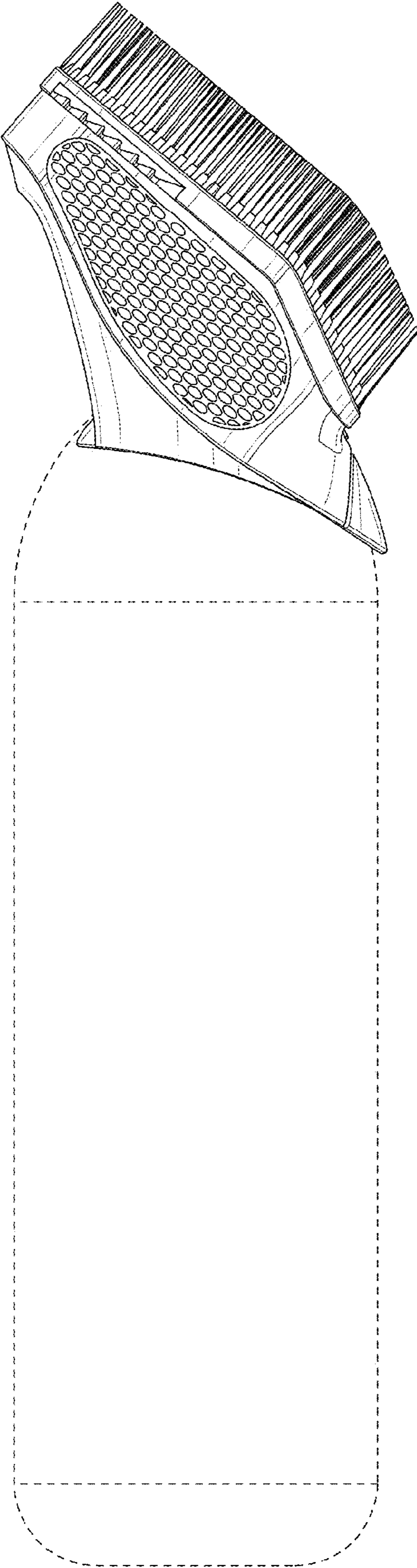

FIG. 5

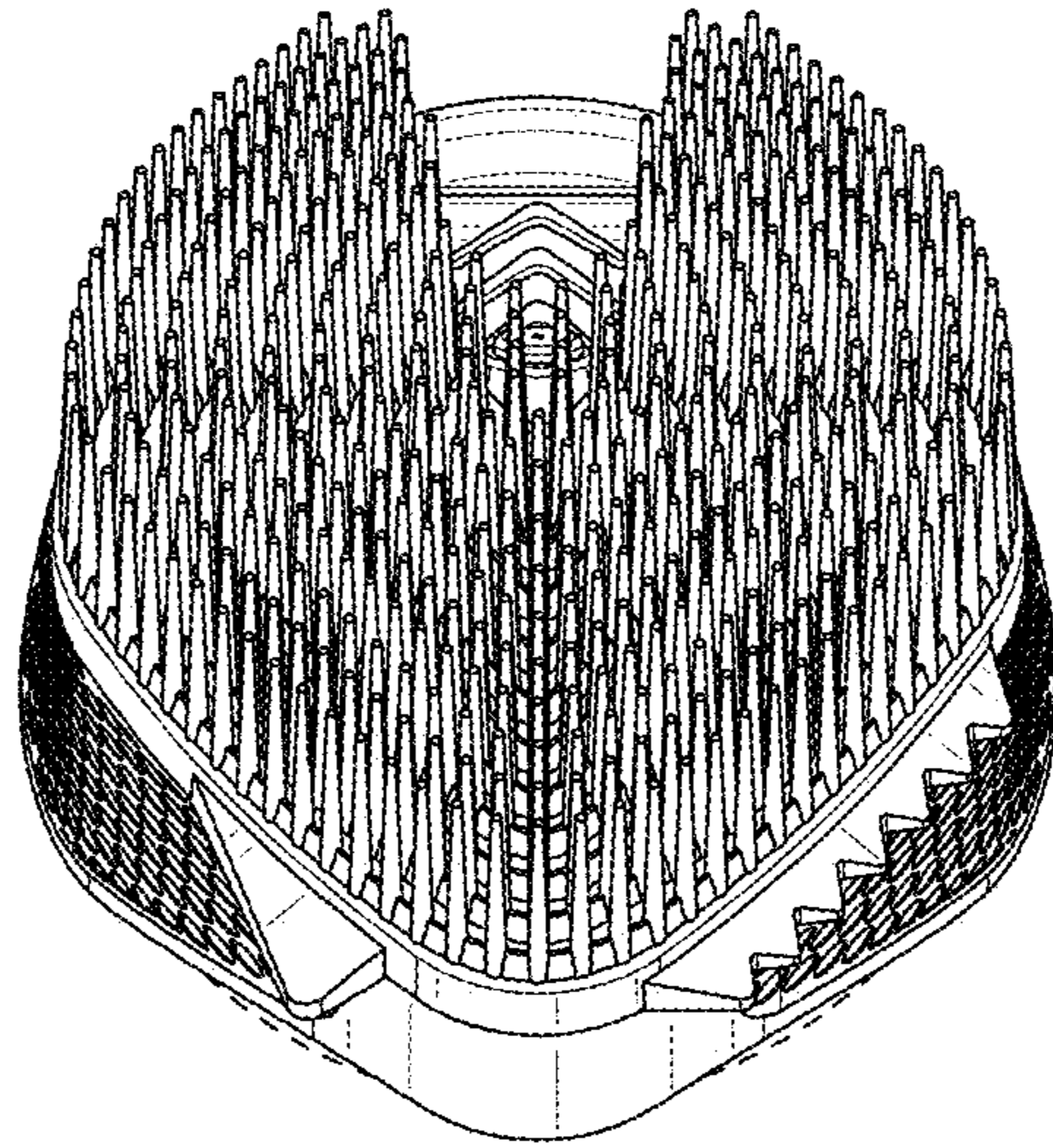

FIG. 6

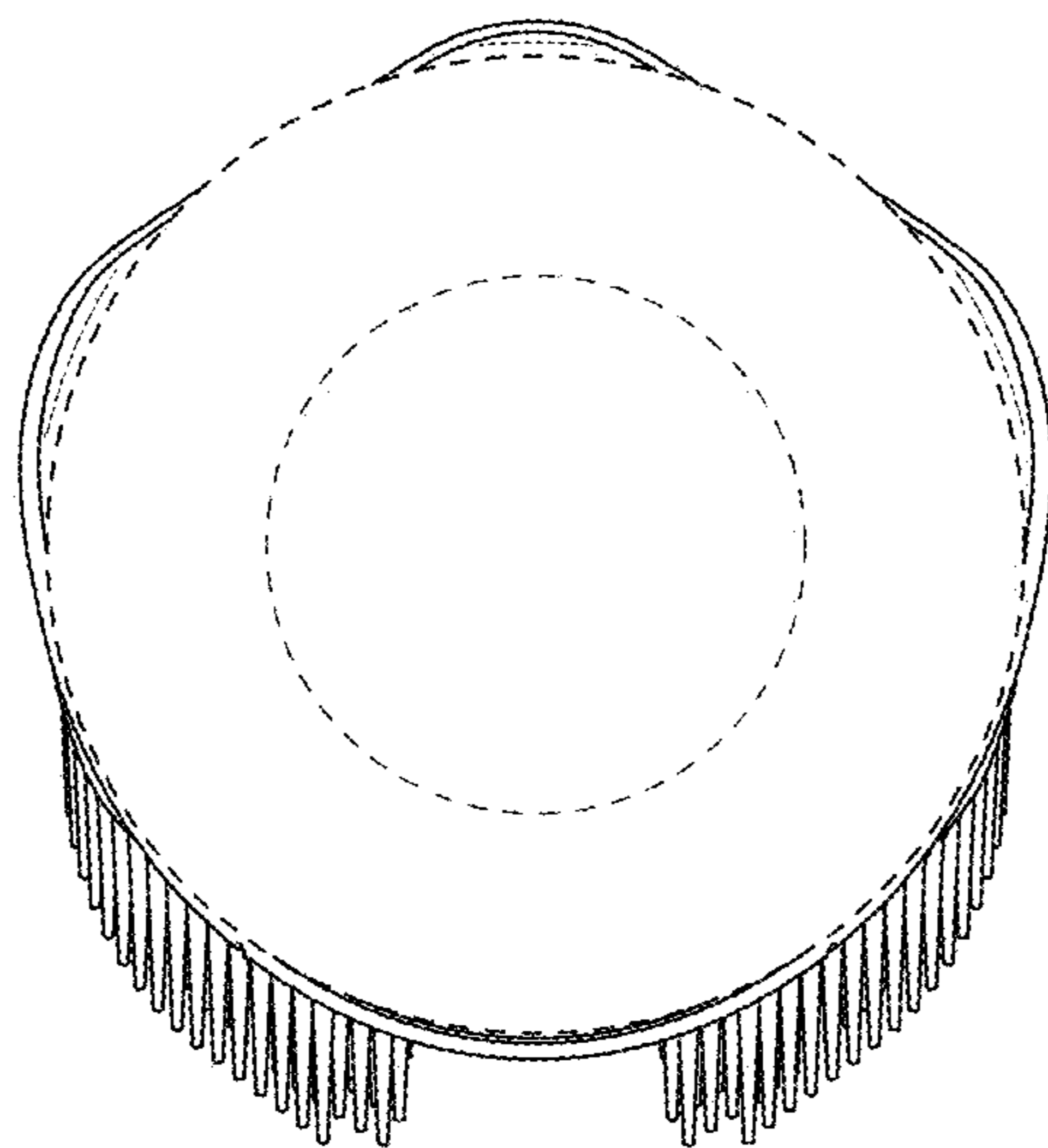

FIG. 7