



US00D957135S

(12) **United States Design Patent** (10) **Patent No.:** **US D957,135 S**  
**Jungnickel et al.** (45) **Date of Patent:** **\*\* Jul. 12, 2022**

(54) **TOOTHBRUSH HEAD**

OTHER PUBLICATIONS

(71) Applicant: **The Gillette Company LLC**, Boston, MA (US)

All Office Actions; U.S. Appl. No. 29/646,252, filed May 2, 2018.

(Continued)

(72) Inventors: **Uwe Jungnickel**, Königstein (DE);  
**Dominik Langhammer**, Frankfurt (DE)

*Primary Examiner* — Cynthia Ramirez

*Assistant Examiner* — Tamara L Hahn

(73) Assignee: **The Gillette Company LLC**, Boston, MA (US)

(74) *Attorney, Agent, or Firm* — Vladimir Vitenberg

(\*\*) Term: **15 Years**

(57) **CLAIM**

(21) Appl. No.: **29/762,793**

The ornamental design for a toothbrush head, as shown and described.

(22) Filed: **Dec. 18, 2020**

(30) **Foreign Application Priority Data**

**DESCRIPTION**

Jul. 2, 2020 (WO) ..... WIPO96064

(51) **LOC (13) Cl.** ..... **04-02**

(52) **U.S. Cl.**  
USPC ..... **D4/110**

(58) **Field of Classification Search**  
USPC ..... D4/100-138, 199; D24/176, 181, 152  
CPC .... A46B 2200/1066; A46B 2200/1073; A46B  
2200/1086; A46B 2200/3093; A46B  
5/0095; A46B 13/023; A46B 9/04; A61C  
17/16; A61C 17/222

See application file for complete search history.

The patent or application file contains at least one drawing executed in color. Copies of this patent or patent application publication with color drawing(s) will be provided by the Office upon request and payment of the necessary fee.

FIG. 1 is a perspective view of a first embodiment of a toothbrush head;

FIG. 2 is a front view thereof;

FIG. 3 is a left-side view thereof;

FIG. 4 is a rear view thereof;

FIG. 5 is a right-side view thereof;

FIG. 6 is a top view thereof; and

FIG. 7 is a bottom view thereof.

FIG. 8 is a perspective view of a second embodiment of a toothbrush head;

FIG. 9 is a front view thereof;

FIG. 10 is a left-side view thereof;

FIG. 11 is a rear view thereof;

FIG. 12 is a right-side view thereof;

FIG. 13 is a top view thereof; and,

FIG. 14 is a bottom view thereof.

The broken lines in the drawings depict portions of the toothbrush head that form no part of the claimed design.

(56) **References Cited**

U.S. PATENT DOCUMENTS

2,242,743 A 5/1941 Brown  
4,880,111 A 11/1989 Bagwell  
(Continued)

FOREIGN PATENT DOCUMENTS

CN 1229341 A 9/1999  
CN 1241123 A 1/2000  
(Continued)

**1 Claim, 4 Drawing Sheets**  
**(2 of 4 Drawing Sheet(s) Filed in Color)**

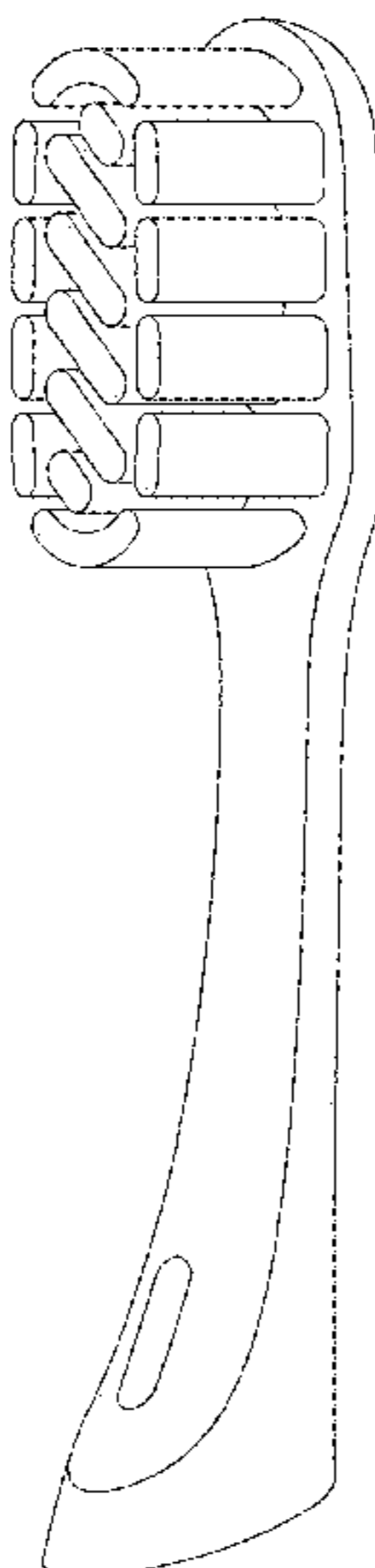



(56)

References Cited

U.S. PATENT DOCUMENTS

D895,295 S 9/2020 Xu  
 D895,296 S 9/2020 Hu et al.  
 10,792,136 B2 10/2020 May et al.  
 D901,183 S 11/2020 Jungnickel et al.  
 10,835,025 B2 11/2020 Kirchofer et al.  
 10,835,028 B2 11/2020 Gatzemeyer et al.  
 10,869,742 B2 12/2020 Fritsch et al.  
 10,874,205 B2 12/2020 Alinski et al.  
 D906,678 S 1/2021 Ge  
 D906,688 S 1/2021 Porter et al.  
 D907,369 S 1/2021 Yang  
 10,881,195 B2 1/2021 Nanda  
 D909,065 S 2/2021 Mote et al.  
 10,925,384 B2 2/2021 Hohlbein et al.  
 D912,988 S 3/2021 Langhammer  
 D912,989 S 3/2021 Albay et al.  
 D917,298 S 4/2021 Hallein et al.  
 D919,301 S 5/2021 Zhao  
 D926,048 S 7/2021 Hallein et al.  
 D926,049 S 7/2021 Hallein et al.  
 D927,972 S 8/2021 Hallein et al.  
 11,103,054 B2 8/2021 Altmann et al.  
 D930,989 S 9/2021 Albay et al.  
 D930,990 S 9/2021 Hallein et al.  
 D931,617 S 9/2021 Hallein et al.  
 D931,619 S 9/2021 Hallein et al.  
 D932,777 S 10/2021 Albay et al.  
 D933,368 S 10/2021 Albay et al.  
 D935,187 S \* 11/2021 Hu ..... D4/101  
 D935,188 S \* 11/2021 He ..... D4/101  
 D935,192 S 11/2021 He et al.  
 D936,484 S 11/2021 Hallein et al.  
 D937,582 S 12/2021 Deng  
 D938,732 S 12/2021 Deng  
 2005/0268414 A1 12/2005 Kim  
 2006/0048323 A1 3/2006 Rueb  
 2007/0131241 A1 6/2007 Nanda  
 2007/0163064 A1 7/2007 Wong et al.  
 2009/0013489 A1 1/2009 Binet  
 2010/0115724 A1 5/2010 Huang  
 2012/0124759 A1 5/2012 Fritsch  
 2012/0272996 A1 11/2012 Jimenez  
 2013/0255017 A1 10/2013 Lee  
 2015/0113747 A1 4/2015 May et al.  
 2016/0270520 A1 9/2016 Lee  
 2017/0128178 A1 5/2017 Schmidt et al.  
 2018/0021116 A1 1/2018 Störkel  
 2019/0125065 A1 5/2019 Altmann  
 2019/0200740 A1 7/2019 Jungnickel  
 2019/0200742 A1 7/2019 Jungnickel  
 2019/0200743 A1 7/2019 Jungnickel  
 2019/0200748 A1 7/2019 Görich et al.  
 2019/0231063 A1 8/2019 May et al.  
 2020/0077778 A1 3/2020 Jungnickel  
 2020/0179089 A1 6/2020 Serval  
 2020/0315334 A1 10/2020 Meidl  
 2020/0359779 A1 11/2020 Dengler et al.  
 2020/0368003 A1 11/2020 Claire-zimmer et al.  
 2020/0397130 A1 12/2020 Ganninger et al.  
 2020/0397134 A1 12/2020 Ganninger et al.  
 2020/0397136 A1 12/2020 Ganninger et al.  
 2020/0397137 A1 12/2020 Ganninger et al.  
 2021/0030145 A1 2/2021 Lee et al.  
 2021/0045857 A1 2/2021 Fritsch et al.  
 2021/0145539 A1 5/2021 Greve  
 2021/0145557 A1 5/2021 May et al.

FOREIGN PATENT DOCUMENTS

CN 202269590 U 6/2012  
 CN 302898215 S 8/2014  
 DE 3241118 A1 8/1984  
 EM 0024534720002 8/2014  
 EM 003175470-0002 7/2016

EM 004362952-0001 9/2017  
 JP 1232984 S 3/2005  
 JP 1620904 S 12/2018  
 RU 93878 S 5/2010  
 RU 77426 S 2/2011  
 RU 89542 S 8/2014  
 TR 0996950002 3/2019  
 WO DM093043 6/2017

OTHER PUBLICATIONS

All Office Actions; U.S. Appl. No. 29/659,068, filed Aug. 6, 2018.  
 All Office Actions; U.S. Appl. No. 29/659,078, filed Aug. 6, 2018.  
 All Office Actions; U.S. Appl. No. 29/681,302, filed Feb. 25, 2019.  
 All Office Actions; U.S. Appl. No. 29/695,301, filed Jun. 18, 2019.  
 All Office Actions; U.S. Appl. No. 29/699,695, filed Jul. 29, 2019.  
 All Office Actions; U.S. Appl. No. 29/704,079, filed Aug. 30, 2019.  
 All Office Actions; U.S. Appl. No. 29/743,560, filed Jul. 22, 2020.  
 All Office Actions; U.S. Appl. No. 29/746,709, filed Aug. 17, 2020.  
 All Office Actions; U.S. Appl. No. 29/746,718, filed Aug. 17, 2020.  
 All Office Actions; U.S. Appl. No. 29/752,903, filed Sep. 29, 2020.  
 All Office Actions; U.S. Appl. No. 29/752,912, filed Sep. 29, 2020.  
 All Office Actions; U.S. Appl. No. 29/755,910, filed Oct. 23, 2020.  
 All Office Actions; U.S. Appl. No. 29/757,497, filed Nov. 6, 2020.  
 All Office Actions; U.S. Appl. No. 29/757,499, filed Nov. 6, 2020.  
 All Office Actions; U.S. Appl. No. 29/758,249, filed Nov. 13, 2020.  
 All Office Actions; U.S. Appl. No. 29/758,251, filed Nov. 13, 2020.  
 All Office Actions; U.S. Appl. No. 29/758,268, filed Nov. 13, 2018.  
 All Office Actions; U.S. Appl. No. 29/758,274, filed Nov. 13, 2020.  
 All Office Actions; U.S. Appl. No. 29/758,276, filed Nov. 13, 2020.  
 All Office Actions; U.S. Appl. No. 29/761,083, filed Dec. 7, 2020.  
 All Office Actions; U.S. Appl. No. 29/761,085, filed Dec. 7, 2020.  
 All Office Actions; U.S. Appl. No. 29/761,086, filed Dec. 7, 2020.  
 All Office Actions; U.S. Appl. No. 29/761,090, filed Dec. 7, 2020.  
 All Office Actions; U.S. Appl. No. 29/786,732, filed Jun. 2, 2021.  
 All Office Actions; U.S. Appl. No. 29/786,746, filed Jun. 2, 2021.  
 All Office Actions; U.S. Appl. No. 29/787,707, filed Jun. 8, 2021.  
 All Office Actions; U.S. Appl. No. 29/794,152, filed Jun. 10, 2018.  
 IFWorldDesignGuide I Entry I Oral-B CLIC, posted on Feb. 12, 2020, © 2021—iF Design [online], [site visited Feb. 26, 2021]. Available from Internet, URL: <https://ifworlddesignguide.com/entry/281978-oral-b-clic/>.  
 Oral-B Brush, announced 2020 [online], [site visited Jul. 24, 2020]. Available from internet, URL: <https://www.amazon.com/Oral-B-Manual-Toothbrush-Replacement-Magnetic/dp/B07XZ2P6M6> (Year: 2020).  
 Walmart | Philips Sonicare Sensitive Replacement Toothbrush Heads, posted on Apr. 30, 2019, © 2020 Walmart [online], [site visited Nov. 5, 2020]. Available from Internet, URL: <https://www.walmart.com/ip/Philips-Sonicare-Sensitive-replacement-toothbrush-heads-for-sensitive-teeth-HX6053-64-3-PK/21264305/>.  
 U.S. Appl. No. 29/787,712, filed Jun. 8, 2021, Uwe Jungnickel et al.  
 U.S. Appl. No. 29/782,323, filed May 6, 2021, Christine Hallein et al.  
 All Office Actions; U.S. Appl. No. 29/782,323.  
 All Office Actions; U.S. Appl. No. 29/787,712.  
 U.S. Appl. No. 29/819,318, filed Dec. 14, 2021, Deyran Albay et al.  
 U.S. Appl. No. 29/814,060, filed Nov. 3, 2021, Christine Hallein et al.  
 U.S. Appl. No. 29/814,616, filed Nov. 8, 2021, Christine Hallein et al.  
 All Office Actions; U.S. Appl. No. 29/814,060, filed Nov. 3, 2021.  
 All Office Actions; U.S. Appl. No. 29/814,616, filed Nov. 8, 2021.  
 All Office Actions; U.S. Appl. No. 29/819,318, filed Dec. 14, 2021.

\* cited by examiner

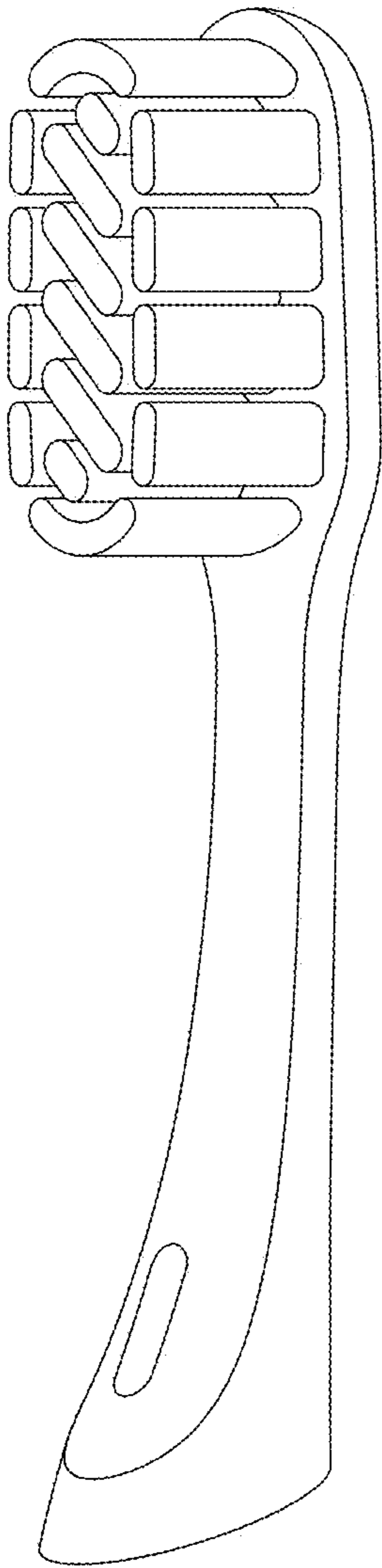

FIG. 1

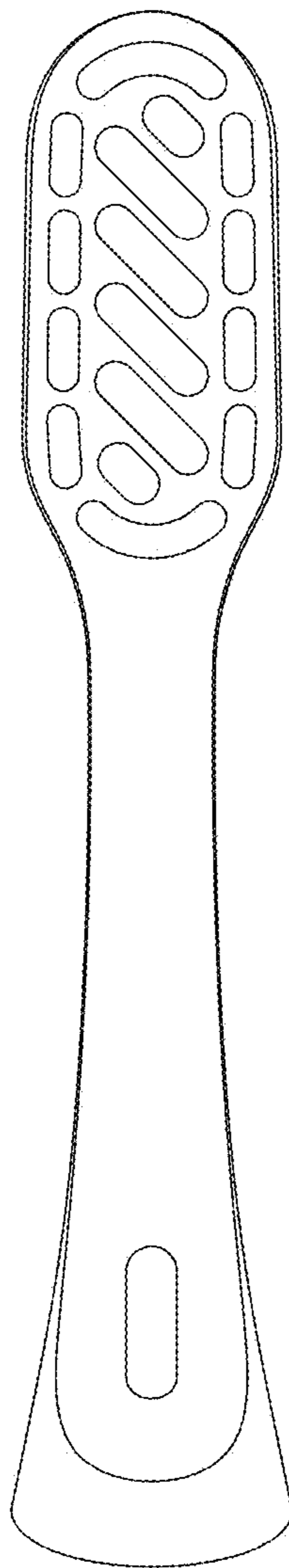

FIG. 2

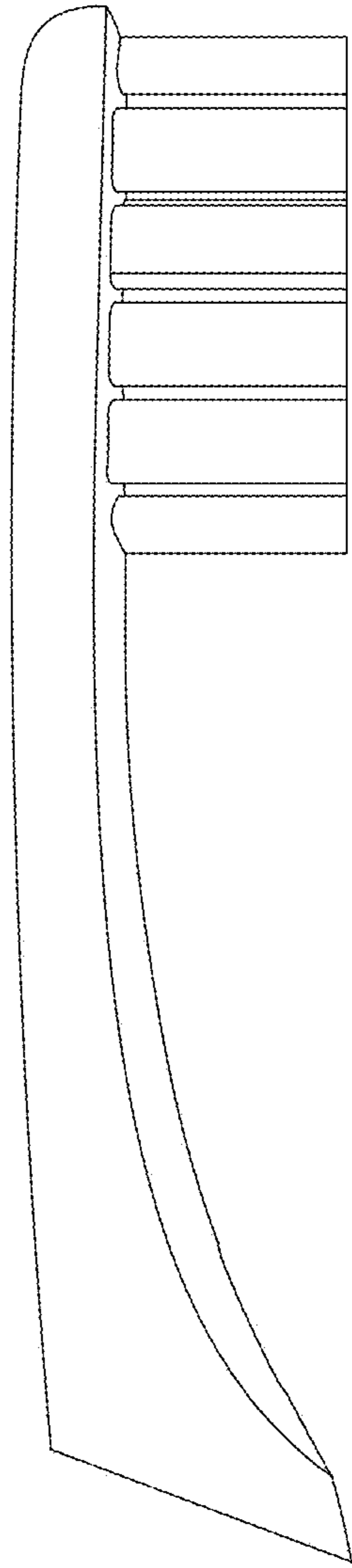

FIG. 3

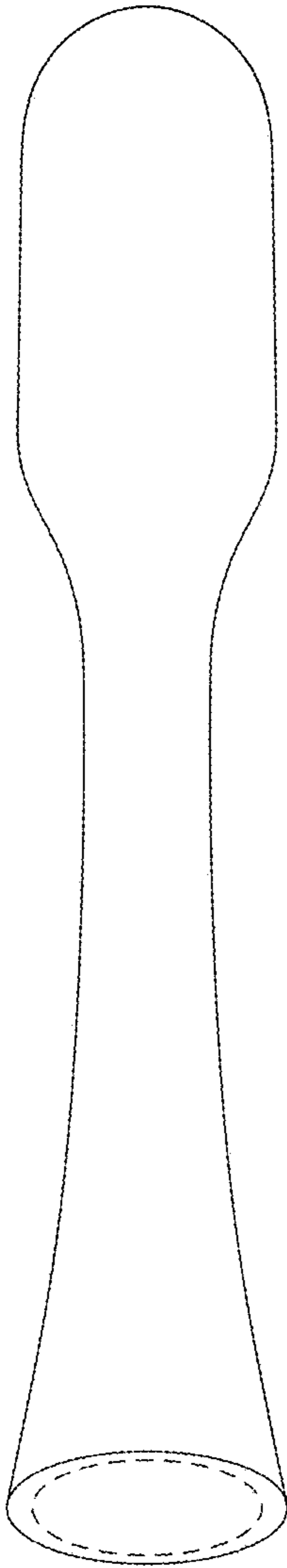

FIG. 4

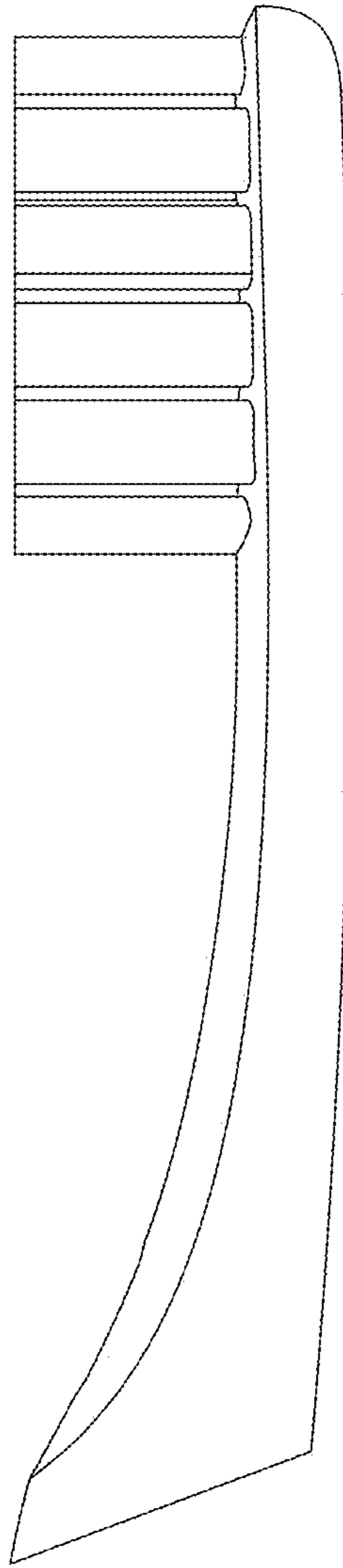

FIG. 5

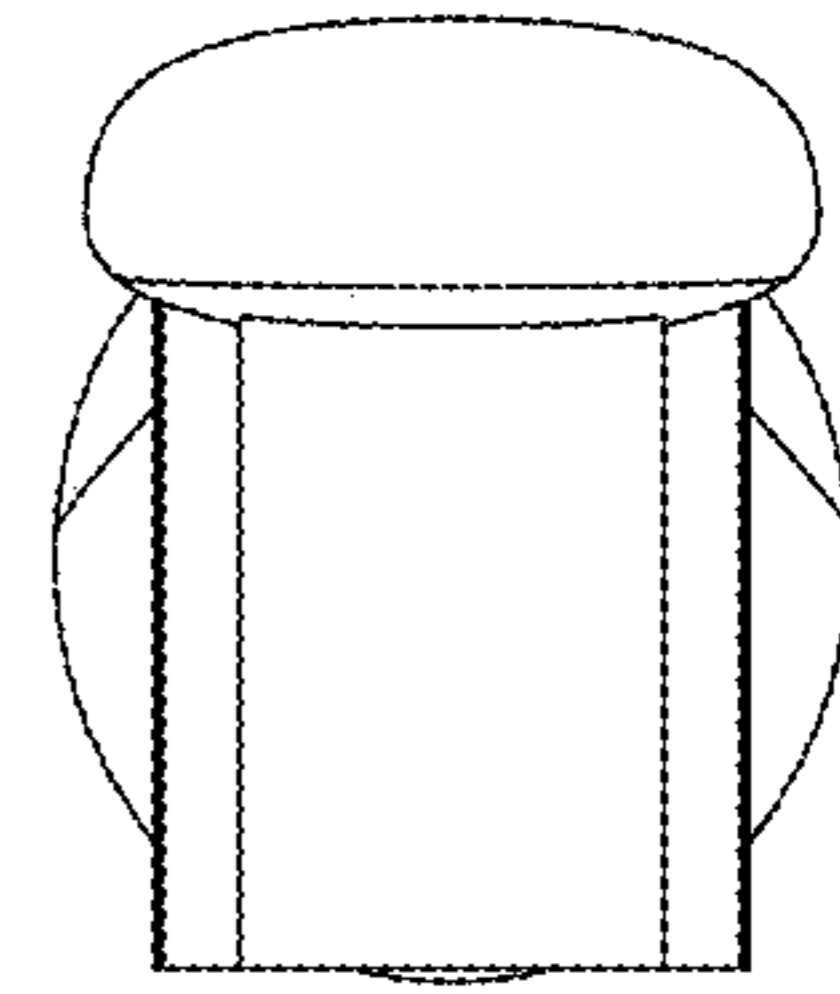

FIG. 6

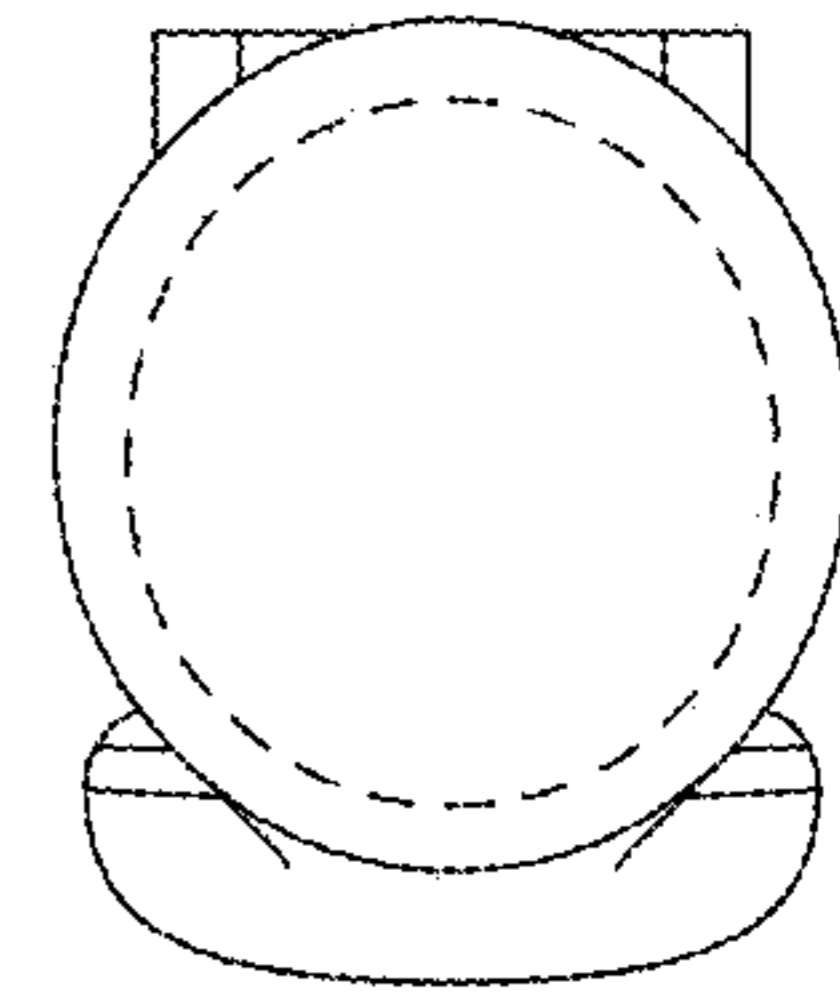

FIG. 7

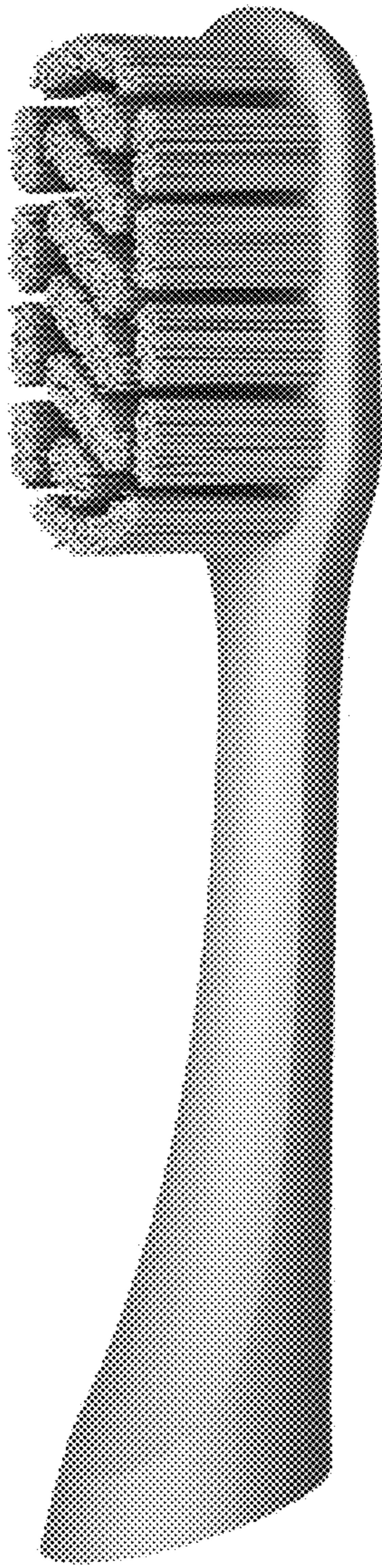

FIG. 8

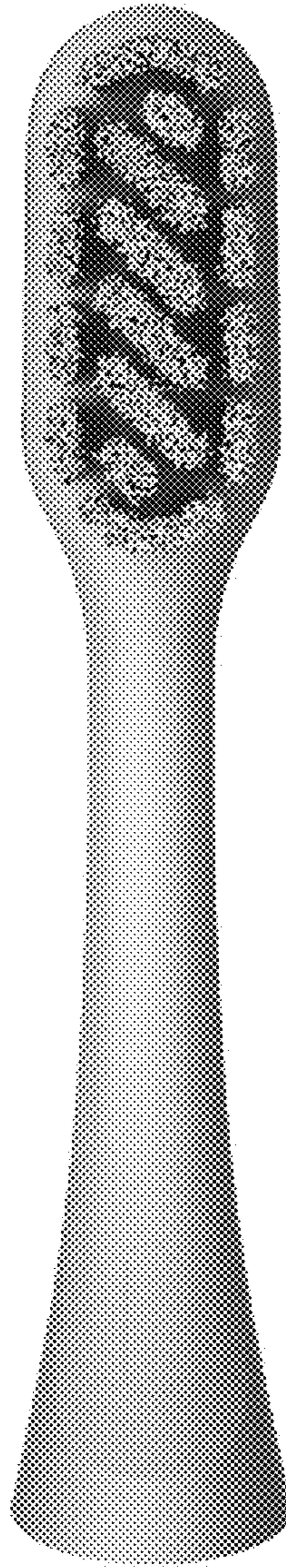

FIG. 9

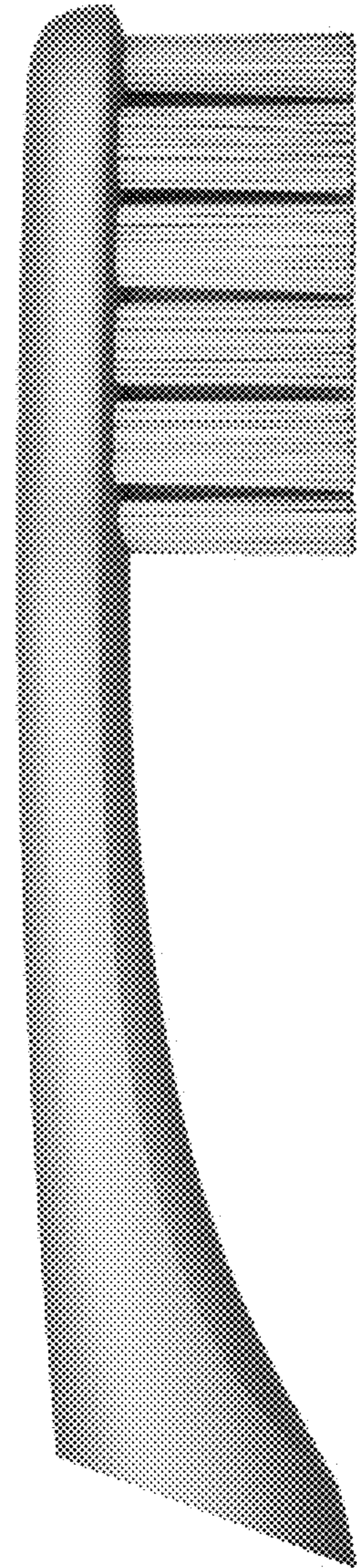

FIG. 10

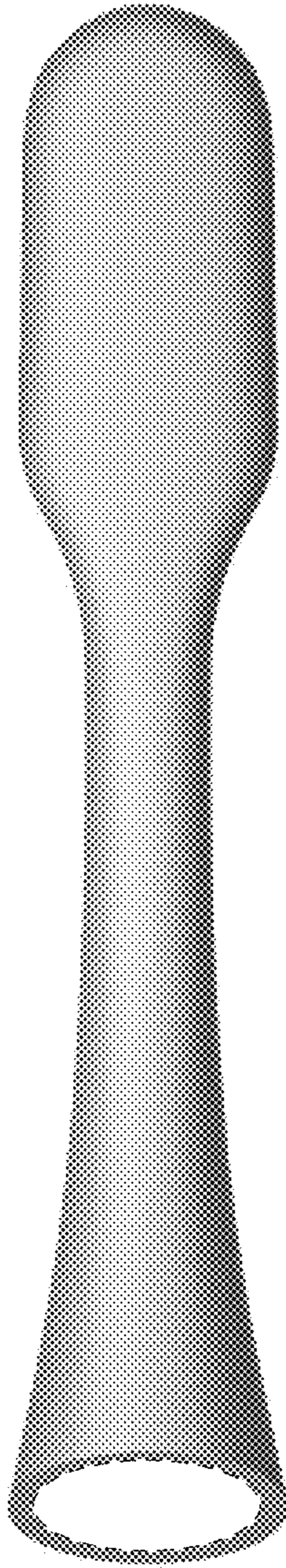

FIG. 11

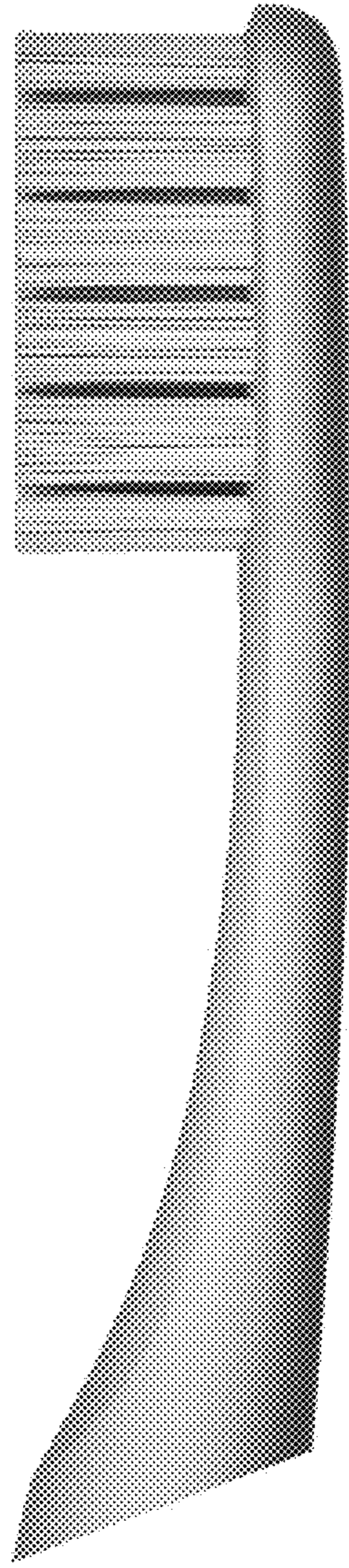

FIG. 12

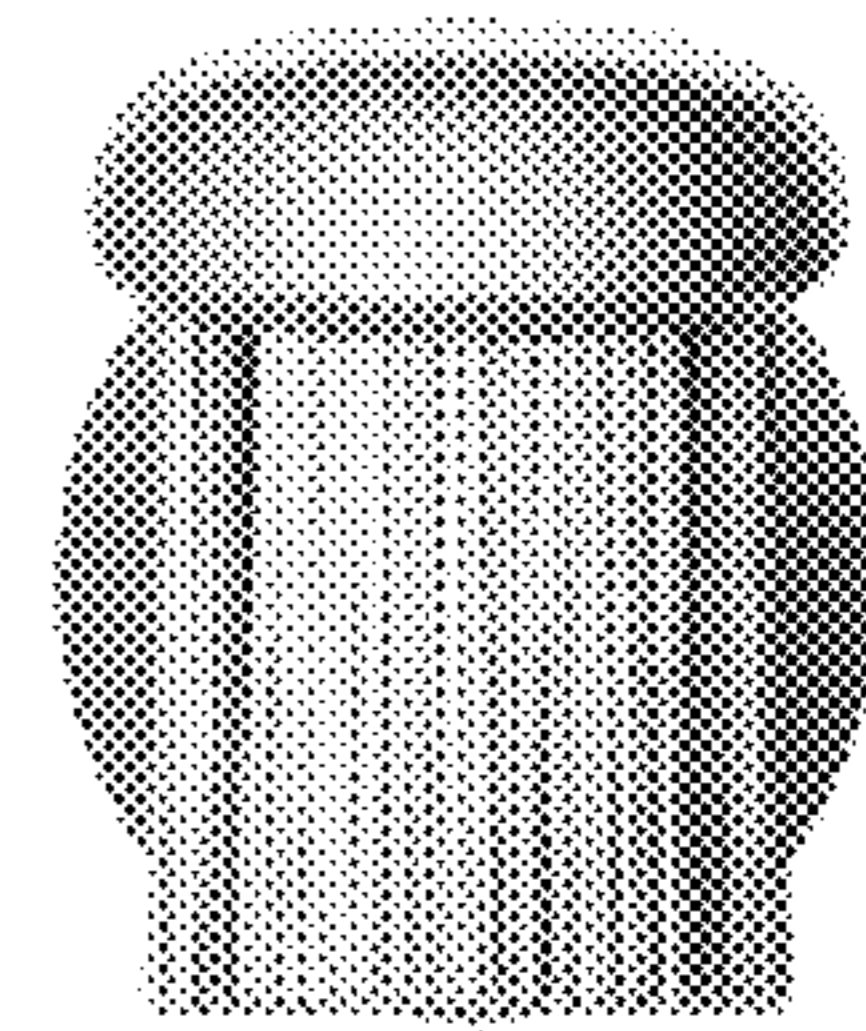

FIG. 13

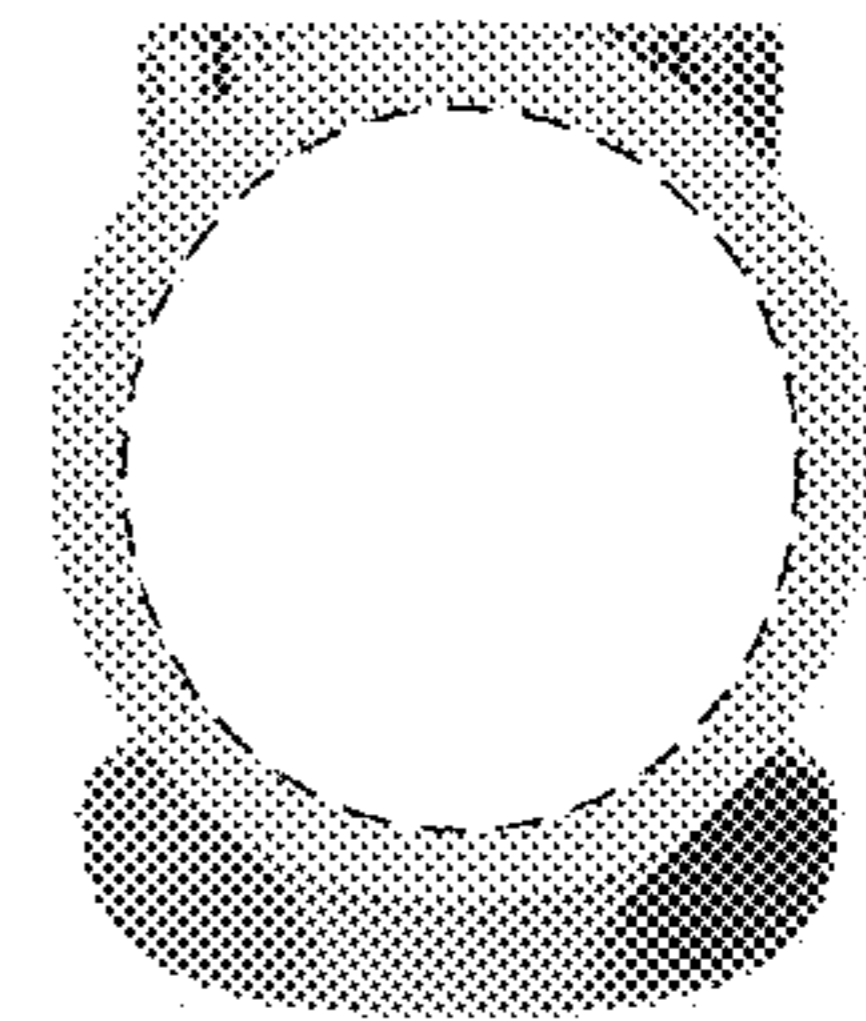

FIG. 14