



US00D957115S

(12) **United States Design Patent** (10) **Patent No.:** **US D957,115 S**
Bibler (45) **Date of Patent:** **** Jul. 12, 2022**

(54) **BACKPACK**

(71) Applicant: **William Roy Bibler**, Winona Lake, IN (US)

(72) Inventor: **William Roy Bibler**, Winona Lake, IN (US)

(**) Term: **15 Years**

(21) Appl. No.: **29/652,050**

(22) Filed: **Apr. 24, 2020**

Related U.S. Application Data

(63) Continuation of application No. 29/637,169, filed on Feb. 14, 2018, now abandoned.

(51) **LOC (13) Cl.** **03-01**

(52) **U.S. Cl.**
USPC **D3/217**

(58) **Field of Classification Search**

USPC D3/215–217, 273, 289, 290, 318, 321, D3/322, 323, 243, 244, 246, 232; 383/72
CPC A45F 4/02; A45F 4/08; A45F 2200/05; A45F 2200/0525; A45F 3/04; A45F 3/042; A45F 3/047; A45F 3/08; A45F 3/10; A45F 3/14; A45C 13/08; A45C 13/083; A45C 13/1046; A45C 2003/007; A45C 3/10

See application file for complete search history.

(56) **References Cited**

U.S. PATENT DOCUMENTS

5,282,765 A * 2/1994 Suzuki A45C 1/12 232/1 D
D401,406 S * 11/1998 Alves D3/215
D411,918 S * 7/1999 Neuman D3/276
D436,441 S * 1/2001 Lapidus D3/273
D446,009 S * 8/2001 Mandell D3/216
D447,870 S * 9/2001 Purcell D3/273

D496,530 S * 9/2004 Wolf D3/273
D505,013 S * 5/2005 Sievers D3/289
D596,856 S * 7/2009 Udwin D3/289

(Continued)

OTHER PUBLICATIONS

Large Heavy-Duty Christmas Tree Canvas Storage Bag for Trees Up to 7.5 ft. Tall, posted at homedepot.com, no posting date, retrieved Jan. 21, 2020, online, URL:https://www.homedepot.com/p/Elf-Stor-Large-Heavy-Duty-Christmas-Tree-Canvas-Storage-Bag-for-Trees-Up-to-7-5-ft-Tall-HWD630069/307939353 (Year: 2020).*

(Continued)

Primary Examiner — Mary Shannon Malley

(74) *Attorney, Agent, or Firm* — Dunlap Bennett & Ludwig, PLLC

(57) **CLAIM**

The ornamental design for a backpack, as shown and described.

DESCRIPTION

FIG. 1 is a front perspective view of a first embodiment of a backpack;
FIG. 2 is a front elevation view thereof;
FIG. 3 is a rear elevation view thereof;
FIG. 4 is a left side elevation view thereof;
FIG. 5 is a right side elevation view thereof;
FIG. 6 is a top plan view thereof;
FIG. 7 is a bottom plan view thereof;
FIG. 8 is a front perspective view of a second embodiment of the backpack;
FIG. 9 is a front elevation view thereof;
FIG. 10 is a rear elevation view thereof;
FIG. 11 is a left side elevation view thereof, the right side elevation view being a mirror image thereof;
FIG. 12 is a top plan view thereof; and,
FIG. 13 is a bottom plan view thereof.

The broken lines shown in the drawings depict portions of the backpack that form no part of the claimed invention.

1 Claim, 8 Drawing Sheets

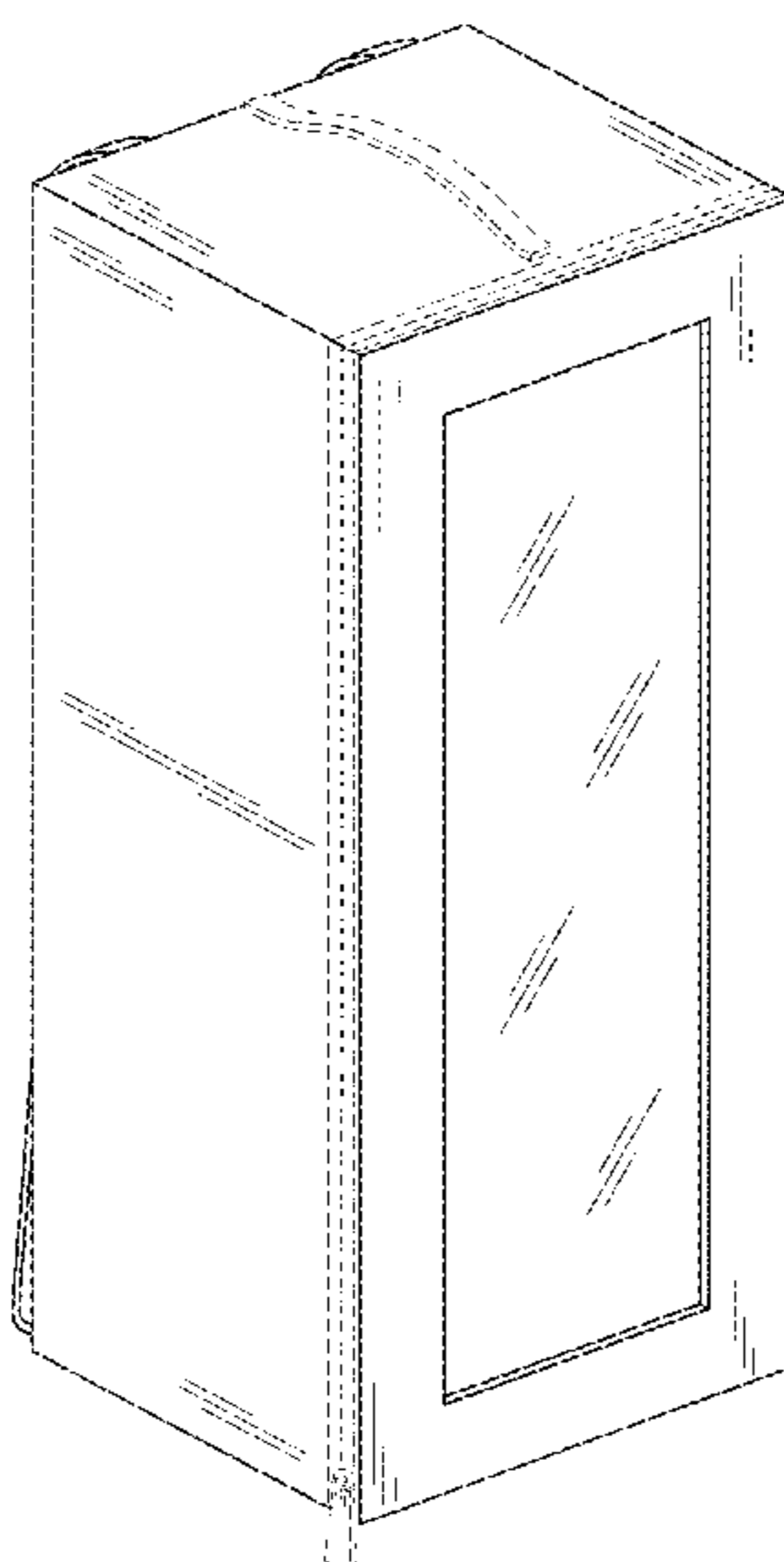

(56)

References Cited

U.S. PATENT DOCUMENTS

D602,253 S * 10/2009 Rees D3/272
2004/0222059 A1 * 11/2004 Glankler A45F 4/02
190/108
2015/0305460 A1 * 10/2015 Mathews A45C 11/00
224/257
2017/0020252 A1 * 1/2017 Chin A45F 3/04

OTHER PUBLICATIONS

Juvale Set of 3 Foldable Storage Boxes with Lid, posted at juvale.com, no posting date, retrieved Jan. 21, 2020, online, URL:<https://juvale.com/collections/storage-boxes-and-bins/products/b0118seaks> (Year: 2020).*

Red Farmhouse Ornament Storage Box, posted at containerstore.com, no posting date, retrieved Jan. 20, 2020, online, URL:<https://www.containerstore.com/s/storage/holiday-storage/red-farmhouse-ornament-storage-box/12d?productId=11010982&theme=storage%20boxes%20with%20lids&pos=34> (Year: 2020).*

* cited by examiner

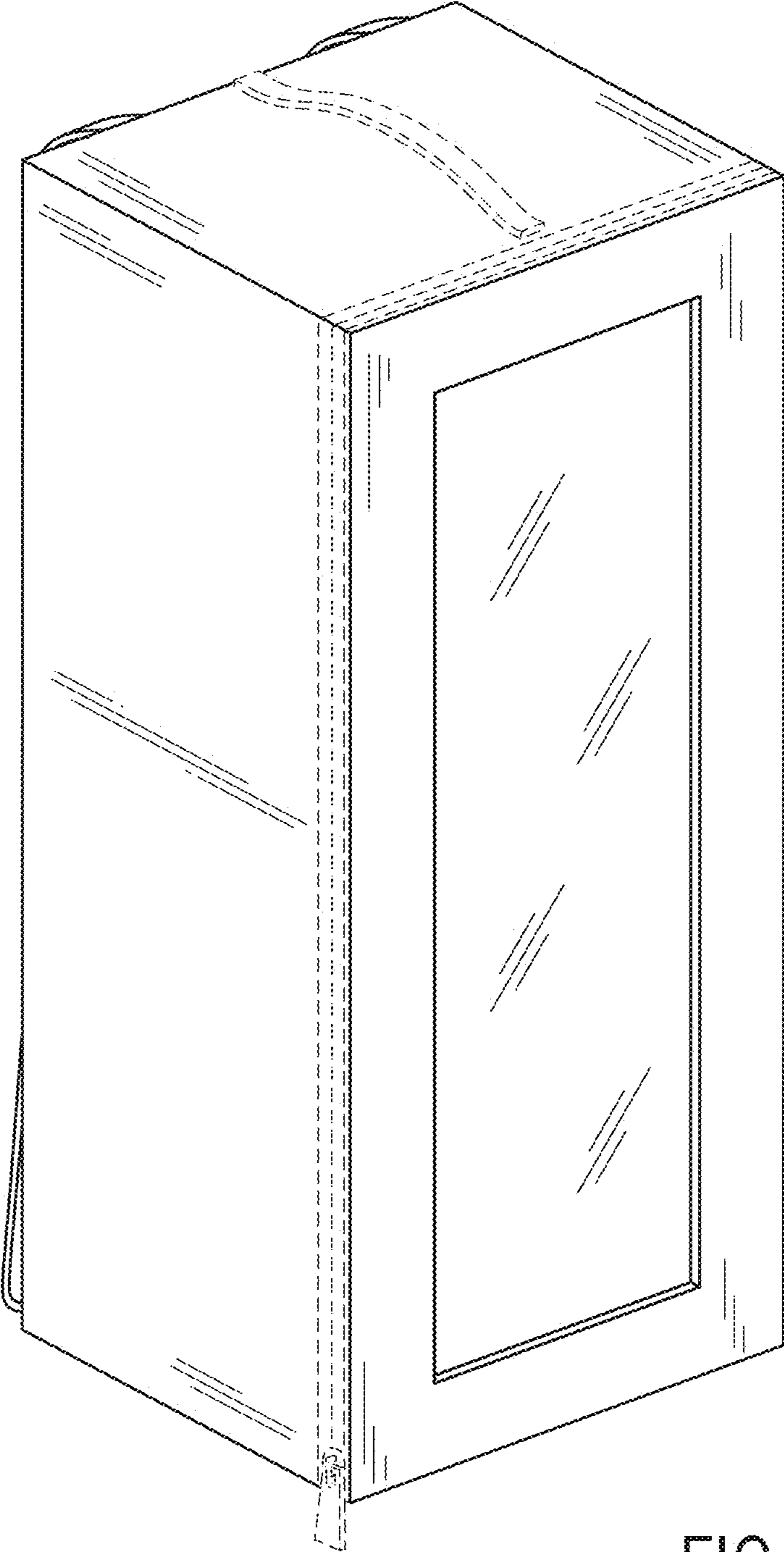

FIG. 1

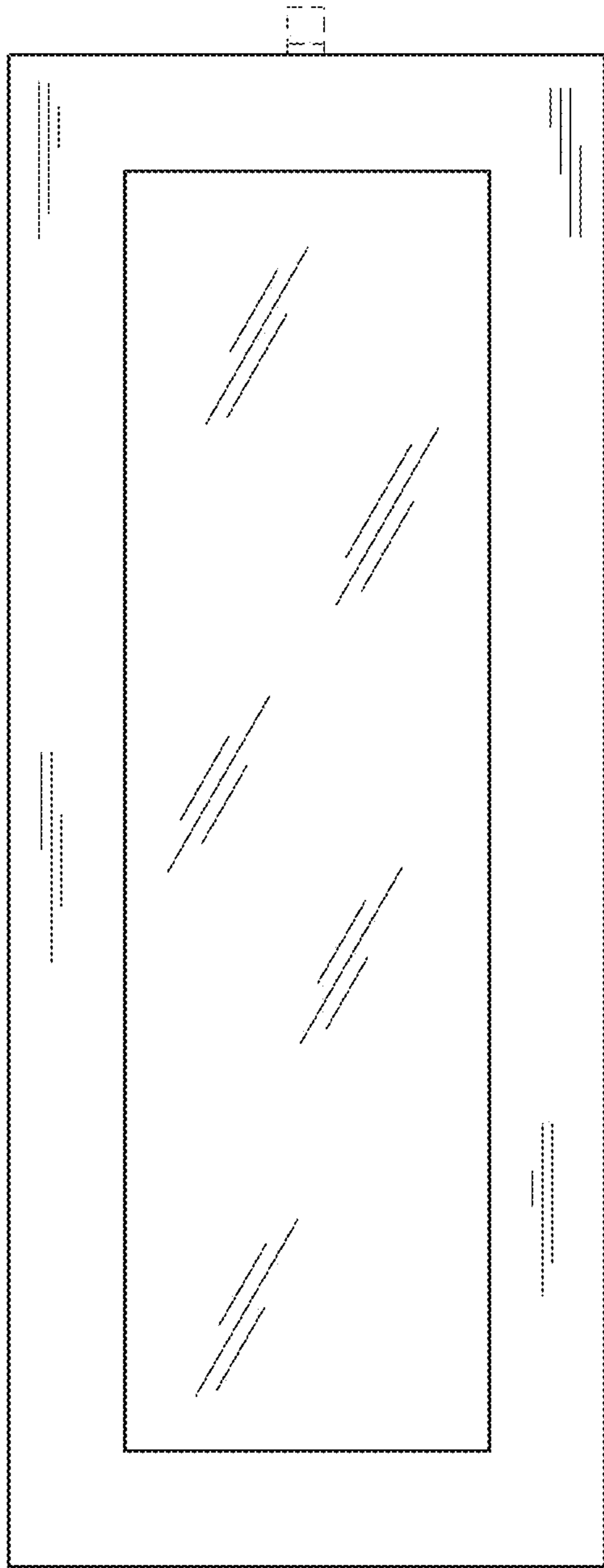

FIG. 2

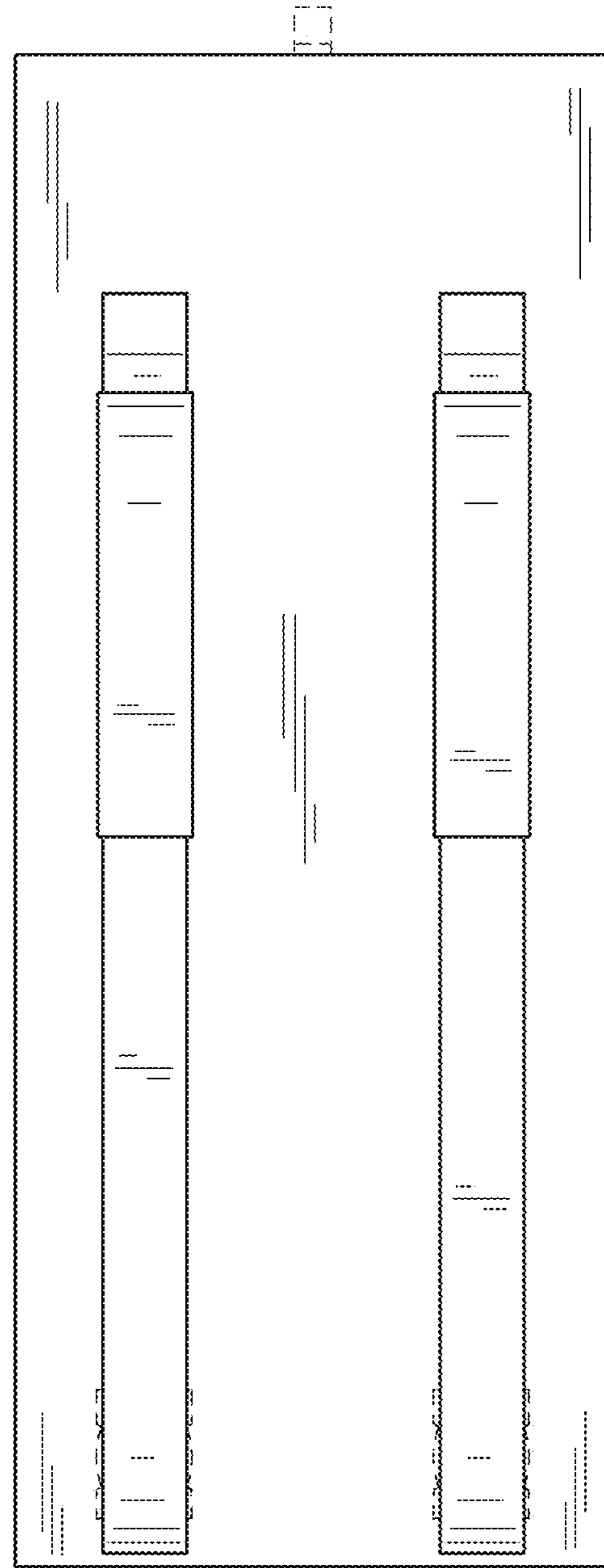

FIG. 3

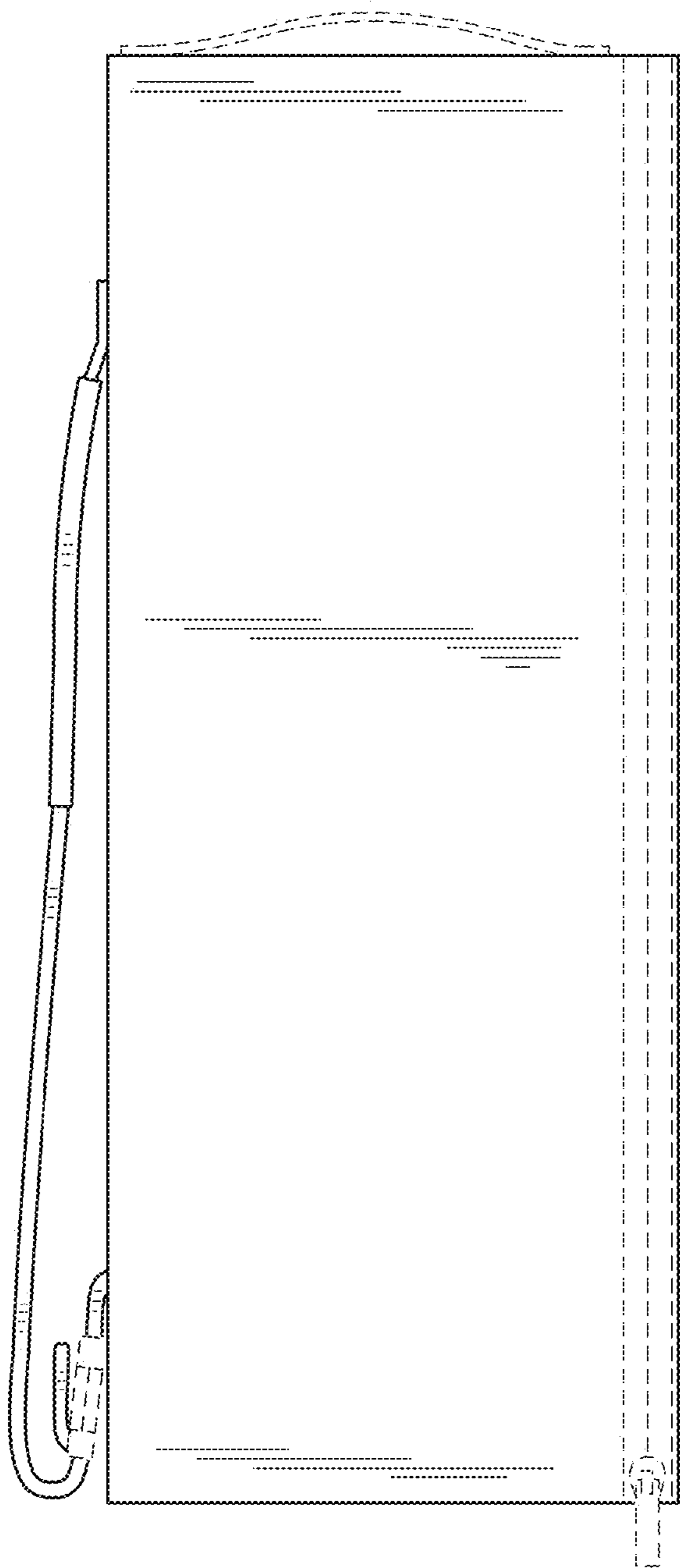

FIG. 4

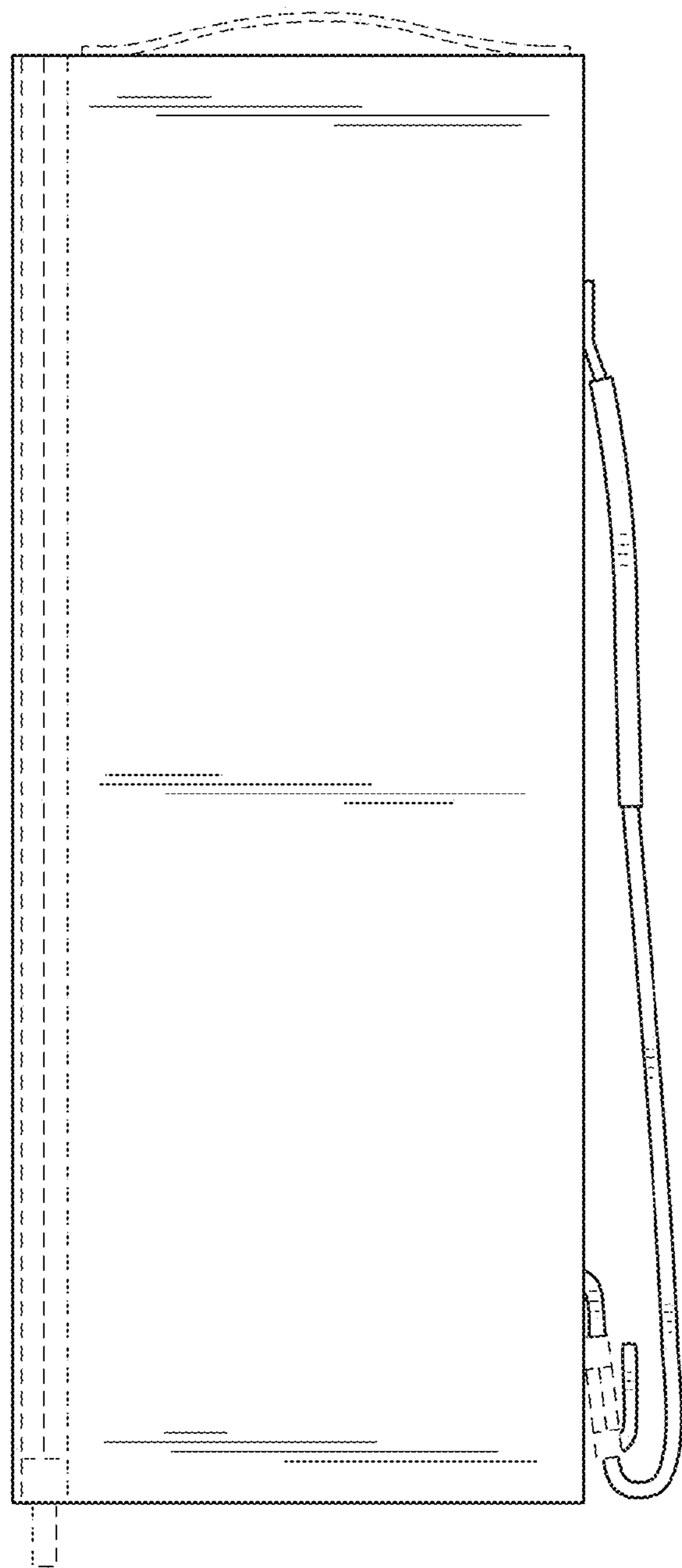

FIG. 5

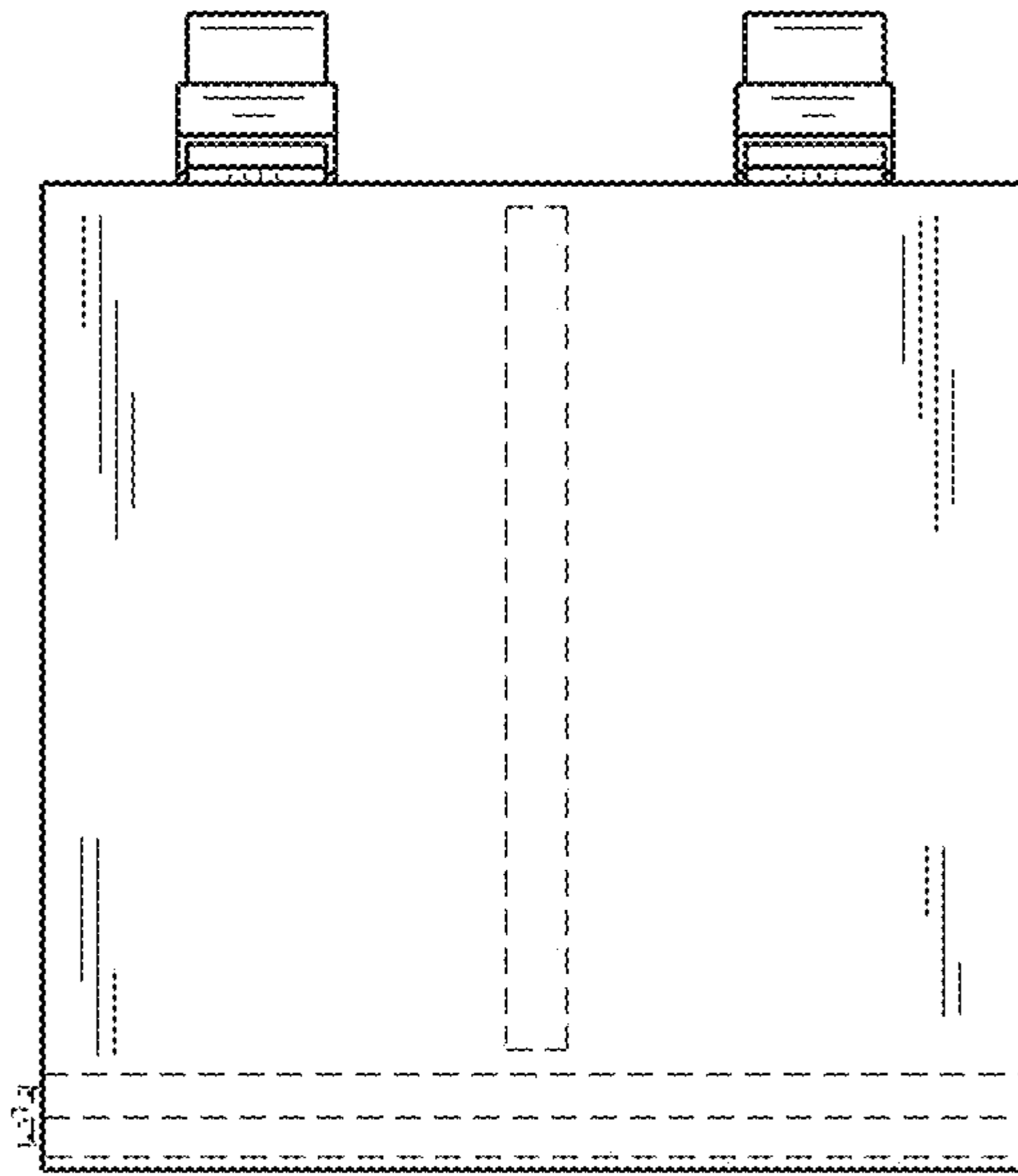

FIG. 6

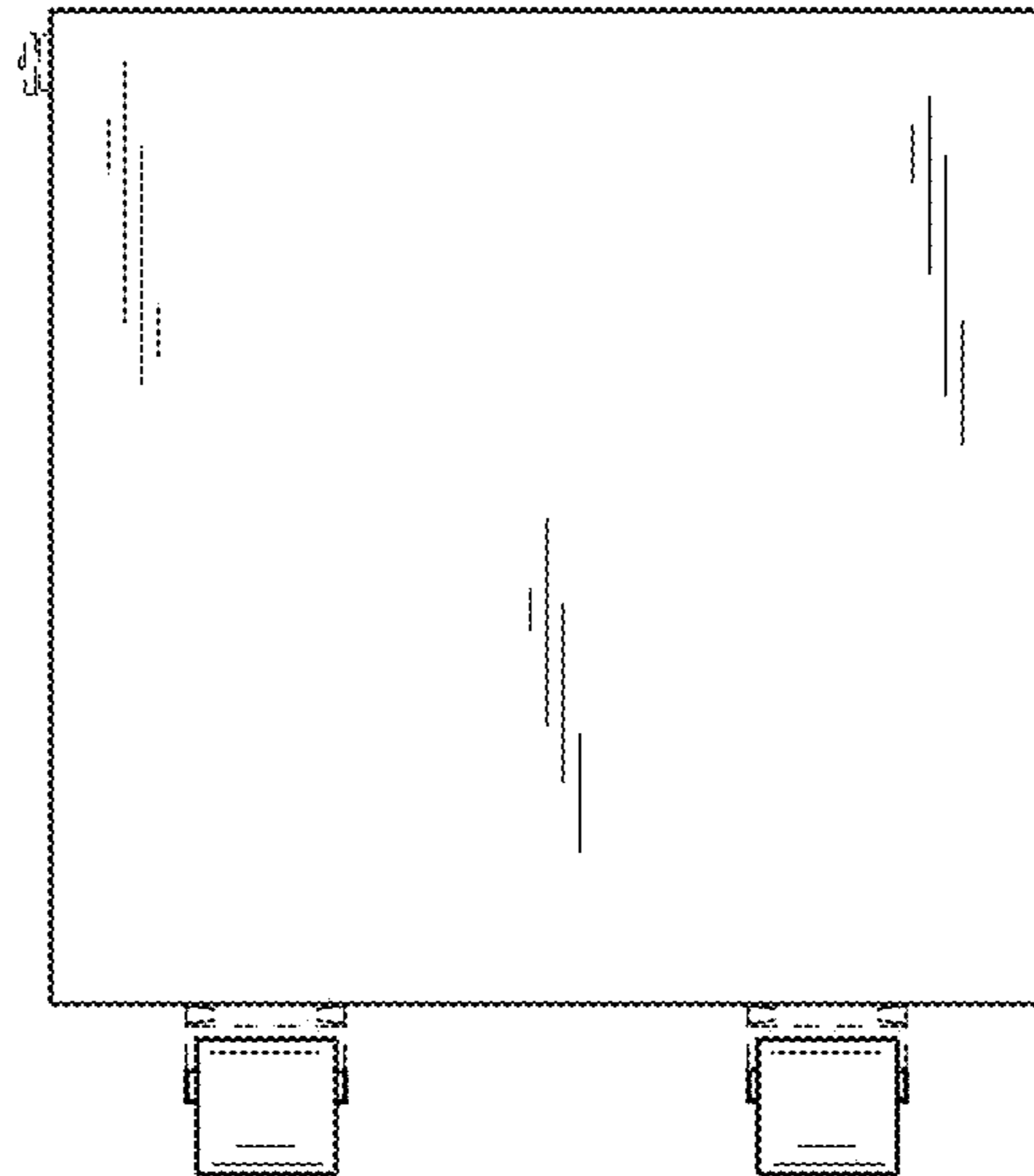

FIG. 7

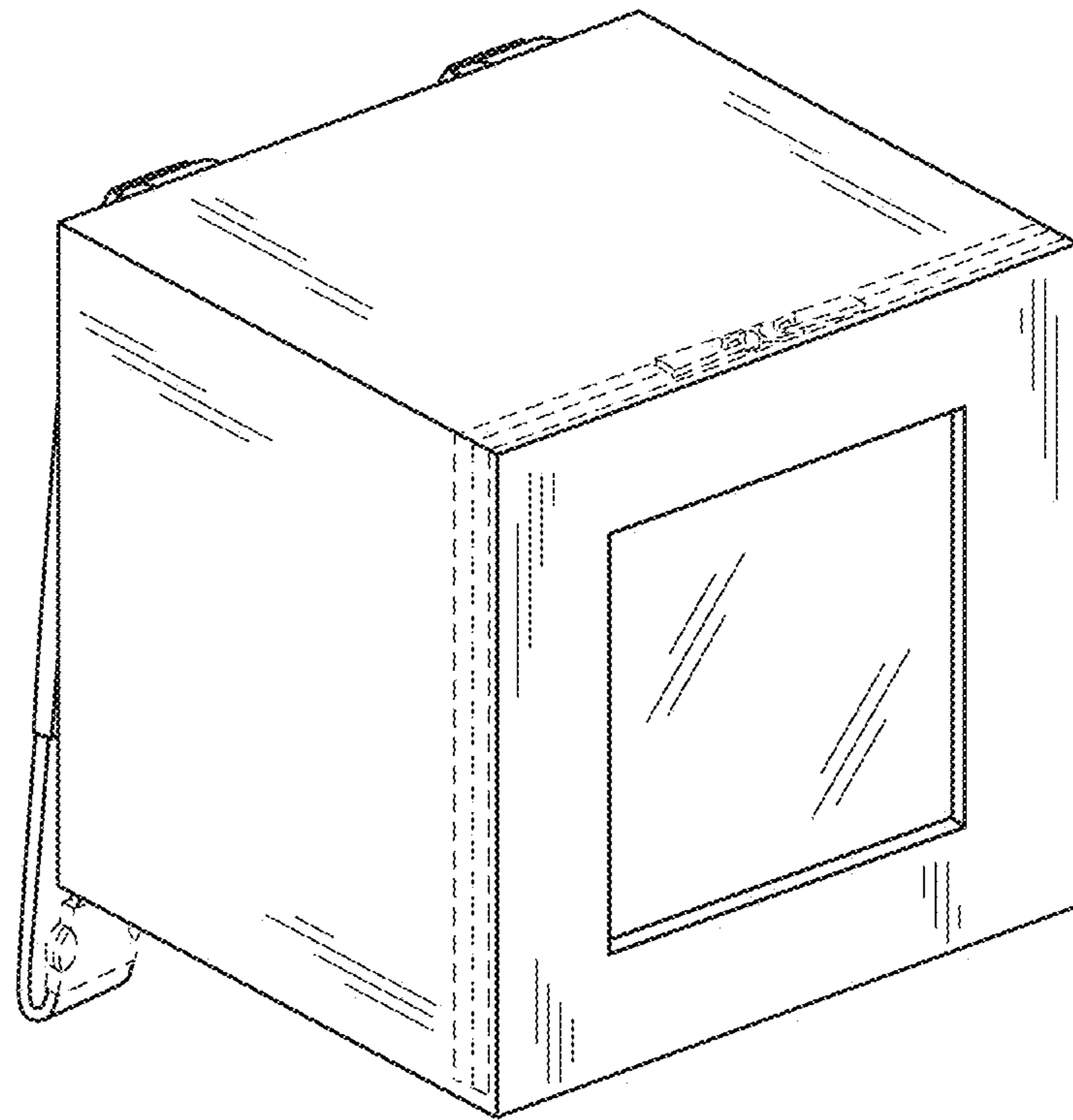

FIG. 8

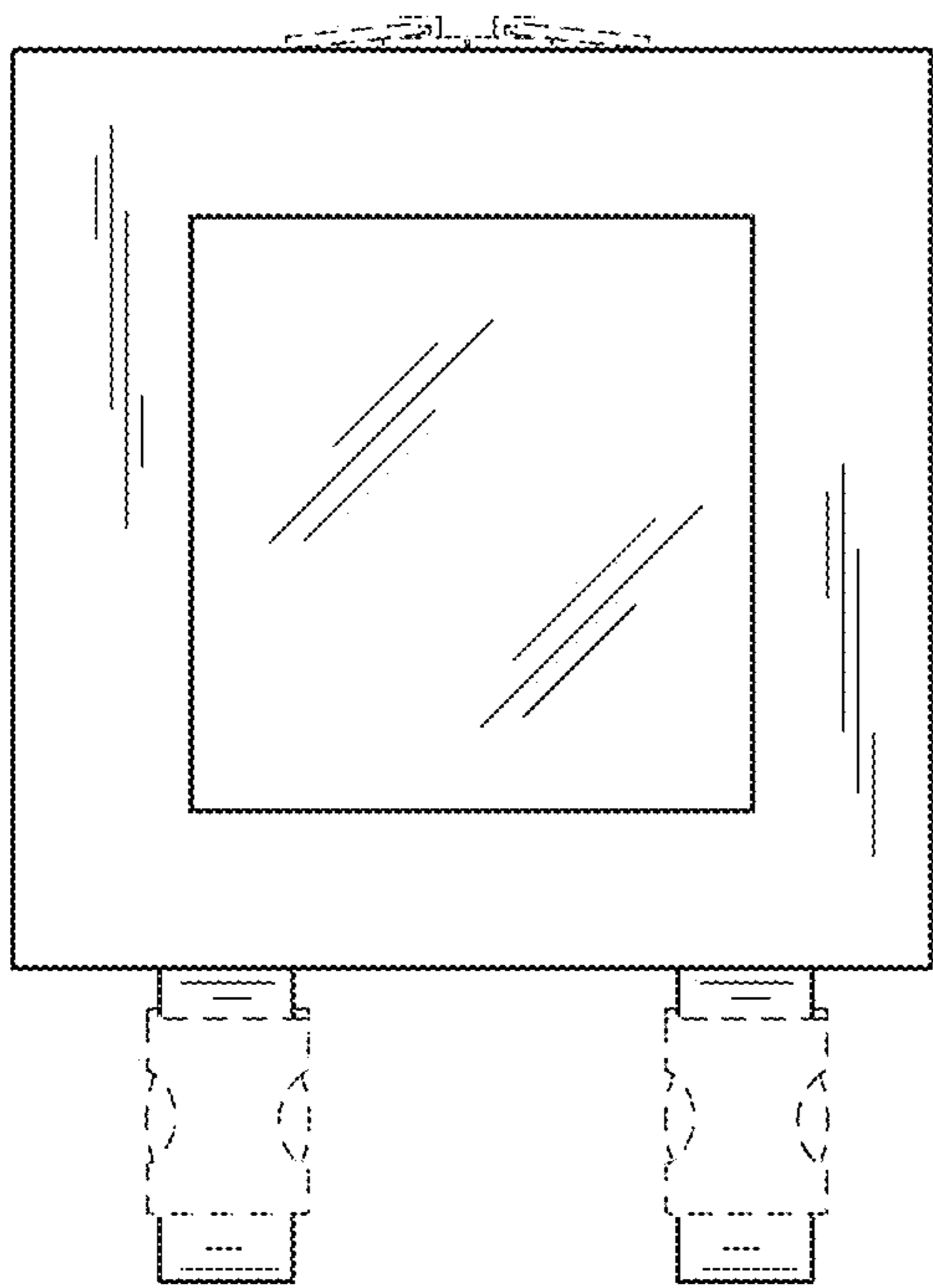

FIG. 9

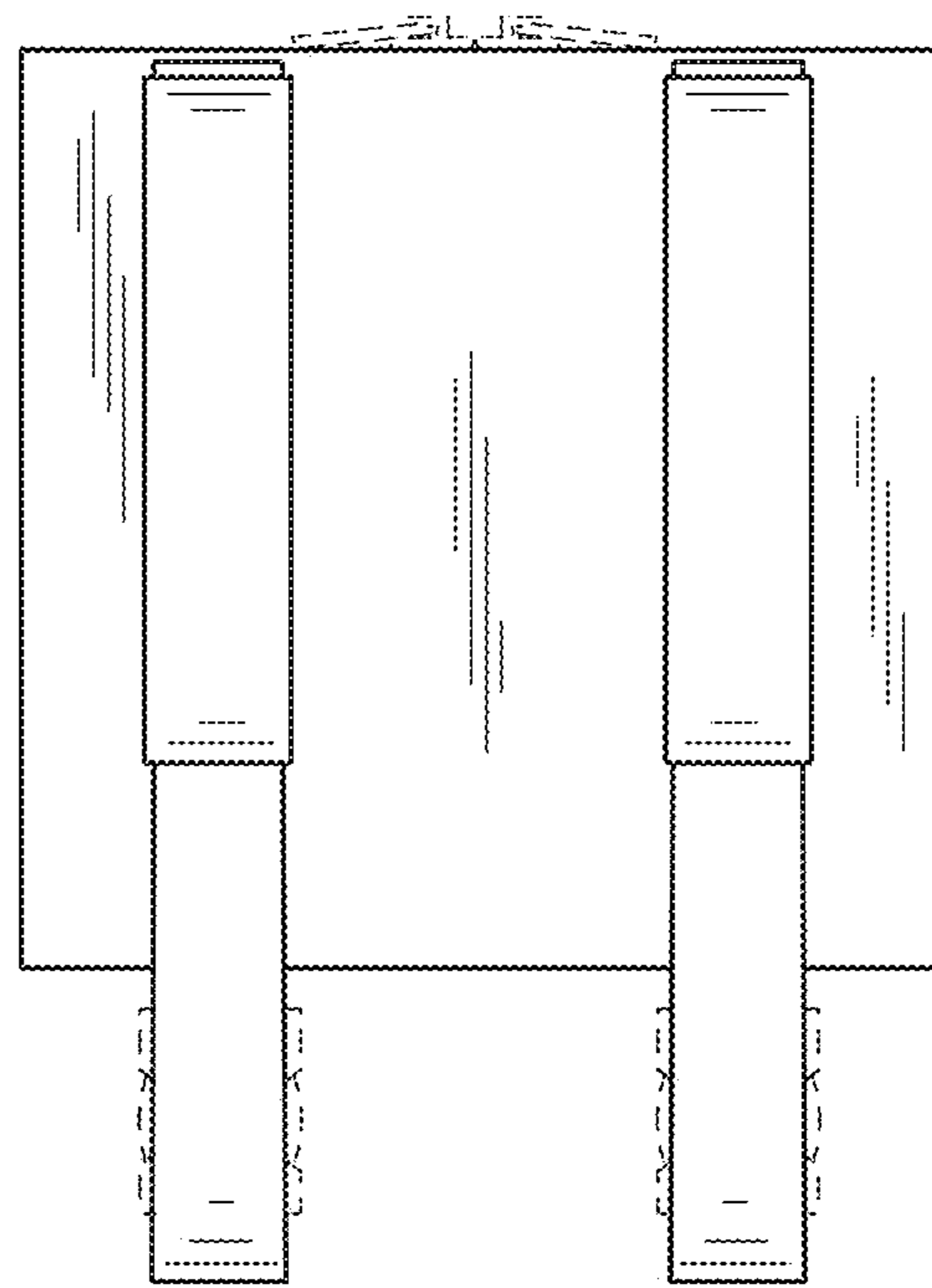

FIG. 10

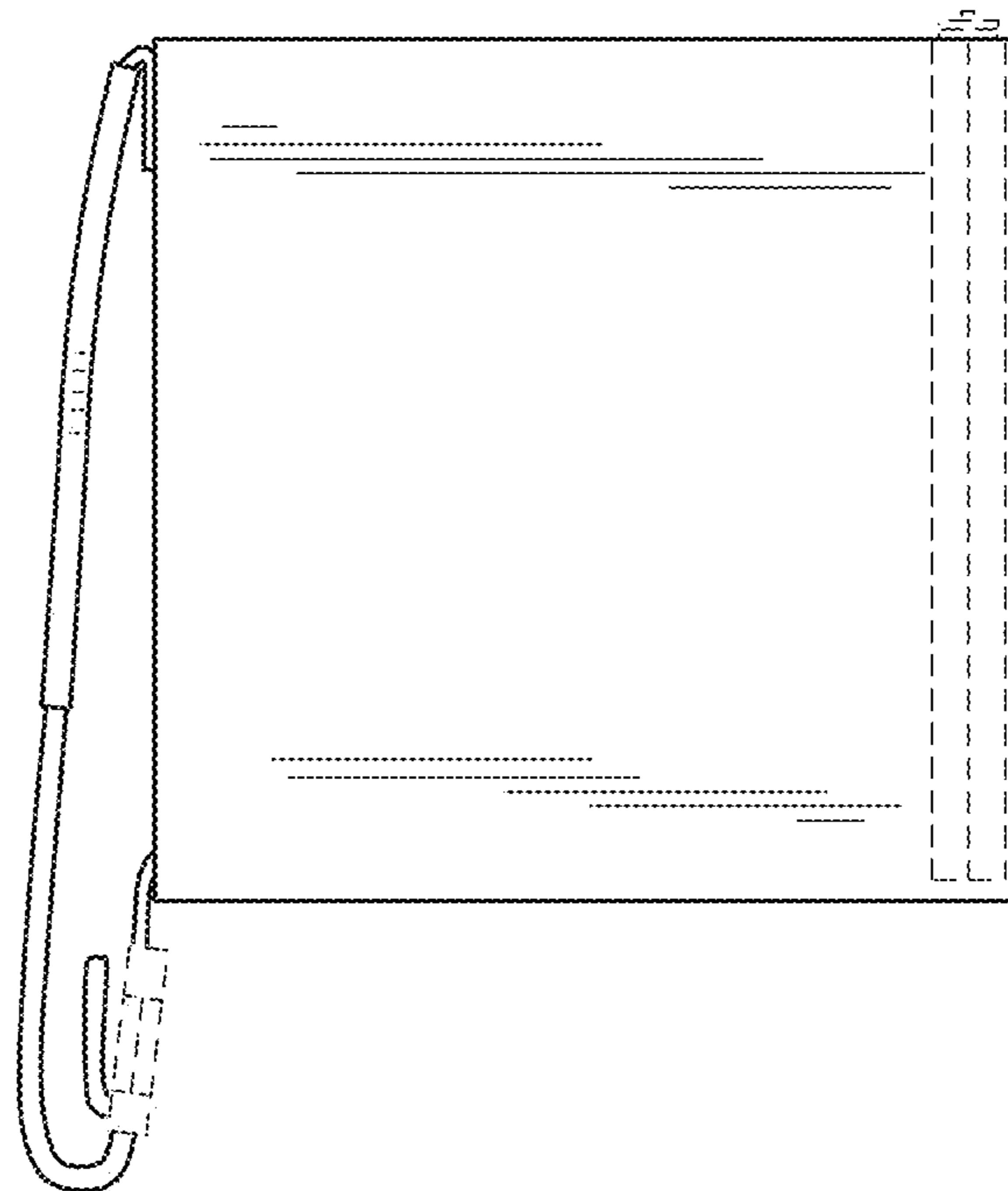

FIG. 11

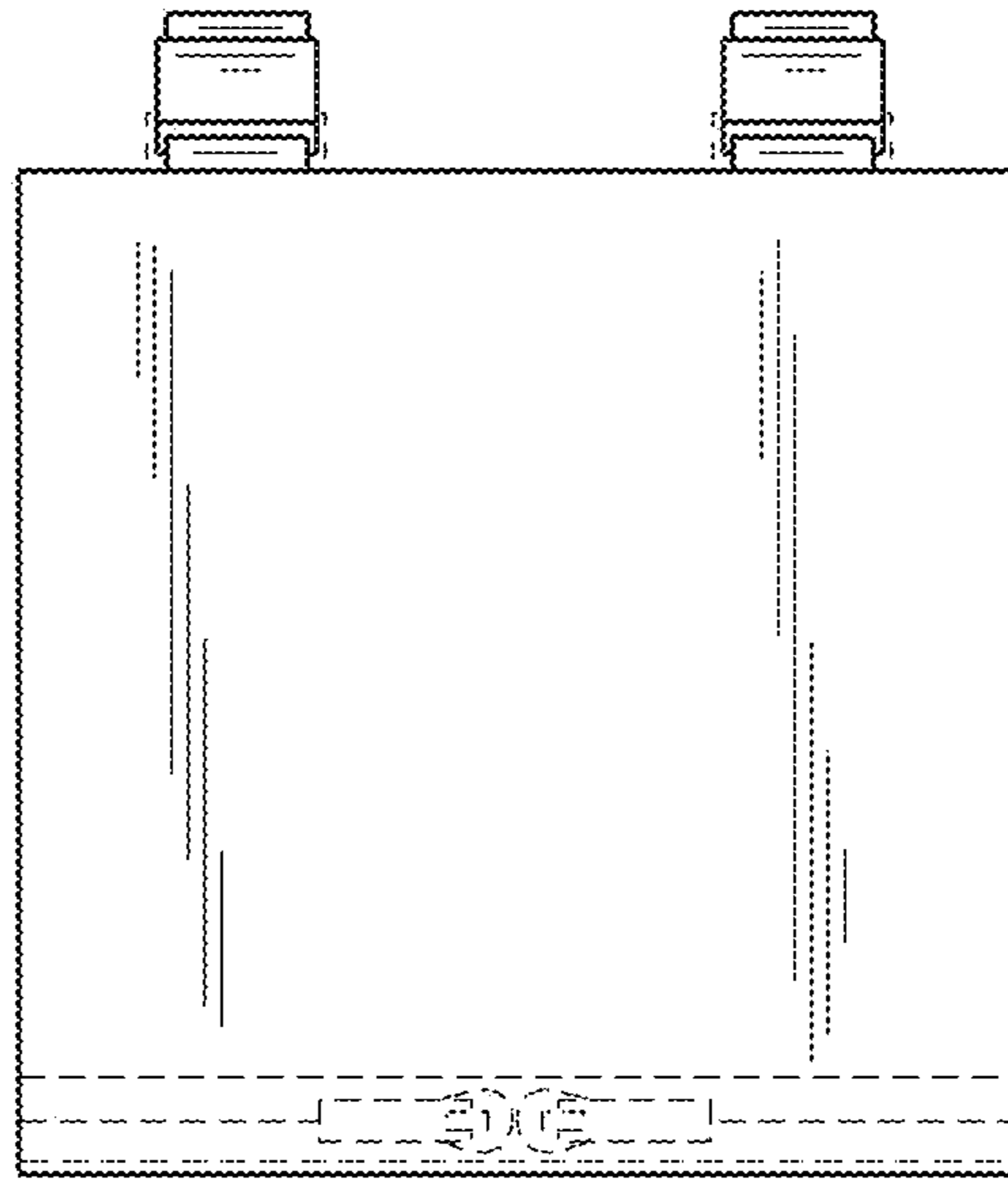

FIG. 12

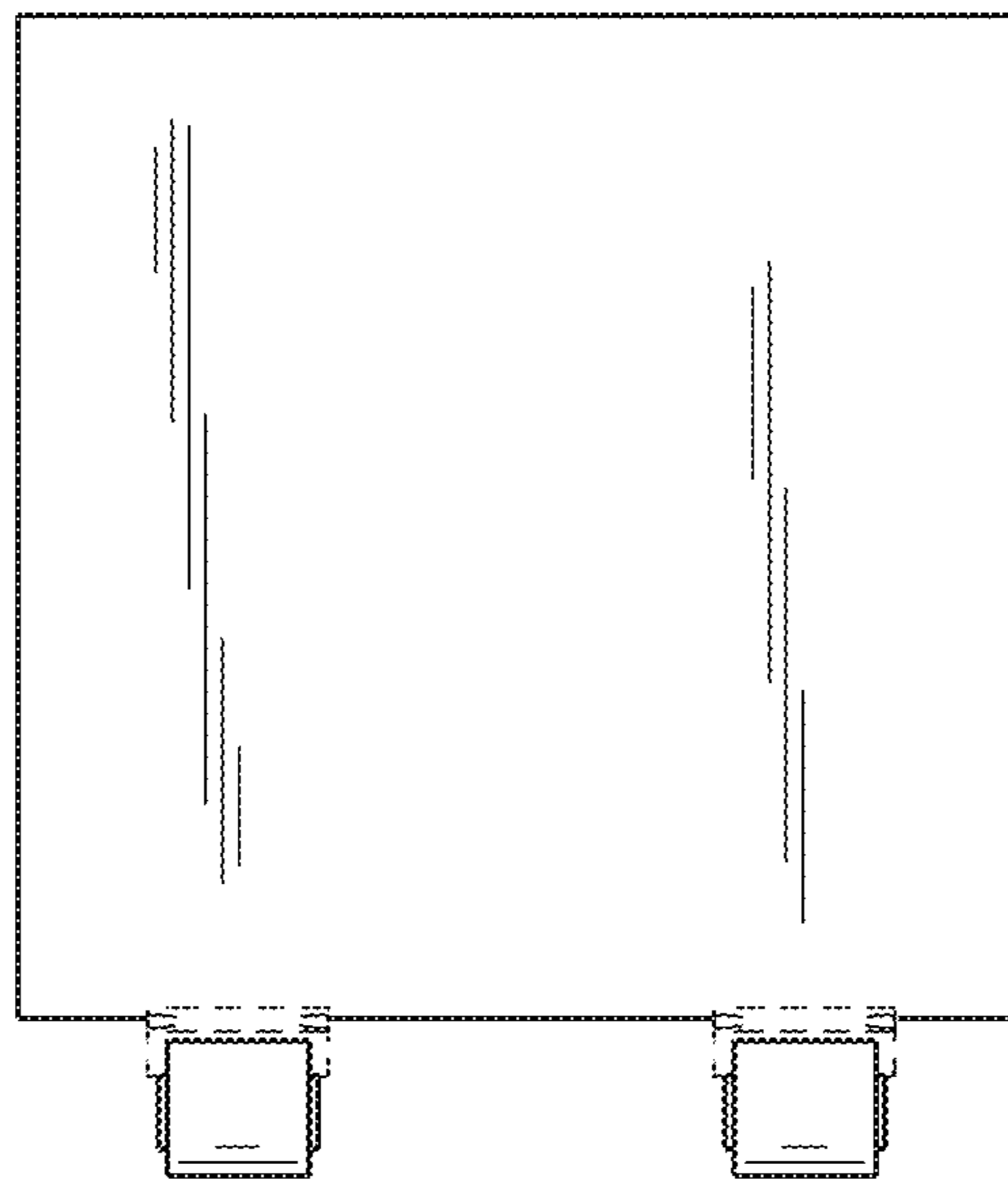

FIG. 13