



US00D957046S

(12) **United States Design Patent**
Liu

(10) **Patent No.:** **US D957,046 S**
(45) **Date of Patent:** **** Jul. 5, 2022**

(54) **ELECTRONIC CIGARETTE ATOMIZER**

(71) Applicant: **Tuanfang Liu**, Shenzhen (CN)

(72) Inventor: **Tuanfang Liu**, Shenzhen (CN)

(**) Term: **15 Years**

(21) Appl. No.: **29/745,579**

(22) Filed: **Aug. 6, 2020**

(30) **Foreign Application Priority Data**

Mar. 16, 2020 (CN) 202030086311.0

(51) **LOC (13) Cl.** **27-02**

(52) **U.S. Cl.**
USPC **D27/162**

(58) **Field of Classification Search**
USPC D27/162, 100, 101, 163–165, 167, 169,
D27/172, 174, 183, 185–192, 194;
D24/110, 110.5; D13/103, 107–109;
D23/360, 366
CPC A24F 47/008; A24F 47/006; A24F 47/002;
A61M 15/00; A61M 15/06
See application file for complete search history.

(56) **References Cited**

U.S. PATENT DOCUMENTS

D871,669 S * 12/2019 Lee D27/194
D875,303 S * 2/2020 Pan D27/162
D875,305 S * 2/2020 Lai D27/167
D889,736 S * 7/2020 Han D27/162
D891,691 S * 7/2020 Chen D27/162

D893,094 S * 8/2020 Wang D27/162
D895,199 S * 9/2020 Li D27/162
D900,385 S * 10/2020 Wang D27/162
D900,386 S * 10/2020 Wang D27/162
D902,473 S * 11/2020 Li D27/101
D904,680 S * 12/2020 Pan D27/162
D908,279 S * 1/2021 Li D27/162
D914,276 S * 3/2021 Lai D27/162
D918,467 S * 5/2021 Wang D27/162
D927,059 S * 8/2021 Lai D27/162
D927,772 S * 8/2021 Han D27/162

* cited by examiner

Primary Examiner — Rebecca Tsehaye

(74) *Attorney, Agent, or Firm* — Matthias Scholl P.C.;
Matthias Scholl

(57) **CLAIM**

The ornamental design for an electronic cigarette atomizer,
as shown and described.

DESCRIPTION

FIG. 1 is a front elevation view of an electronic cigarette atomizer;
FIG. 2 is a rear elevation view thereof;
FIG. 3 is a left-side elevation view thereof;
FIG. 4 is a right-side elevation view thereof;
FIG. 5 is a top plan view thereof;
FIG. 6 is a bottom plan view thereof;
FIG. 7 is a perspective view thereof; and,
FIG. 8 is a bottom perspective view thereof.
The broken lines in the drawings depict portions of the
electronic cigarette atomizer that form no part of the claimed
design.

1 Claim, 8 Drawing Sheets

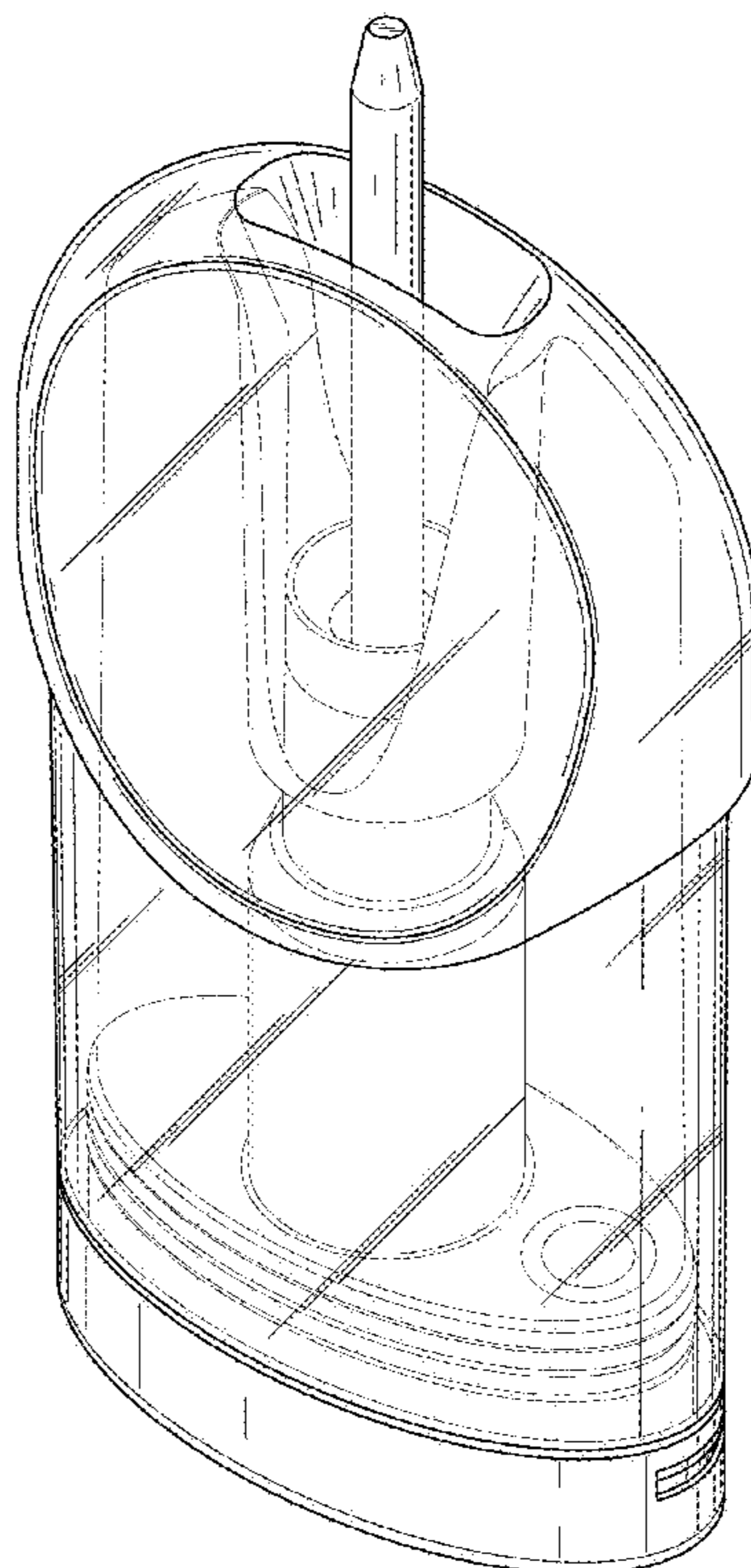

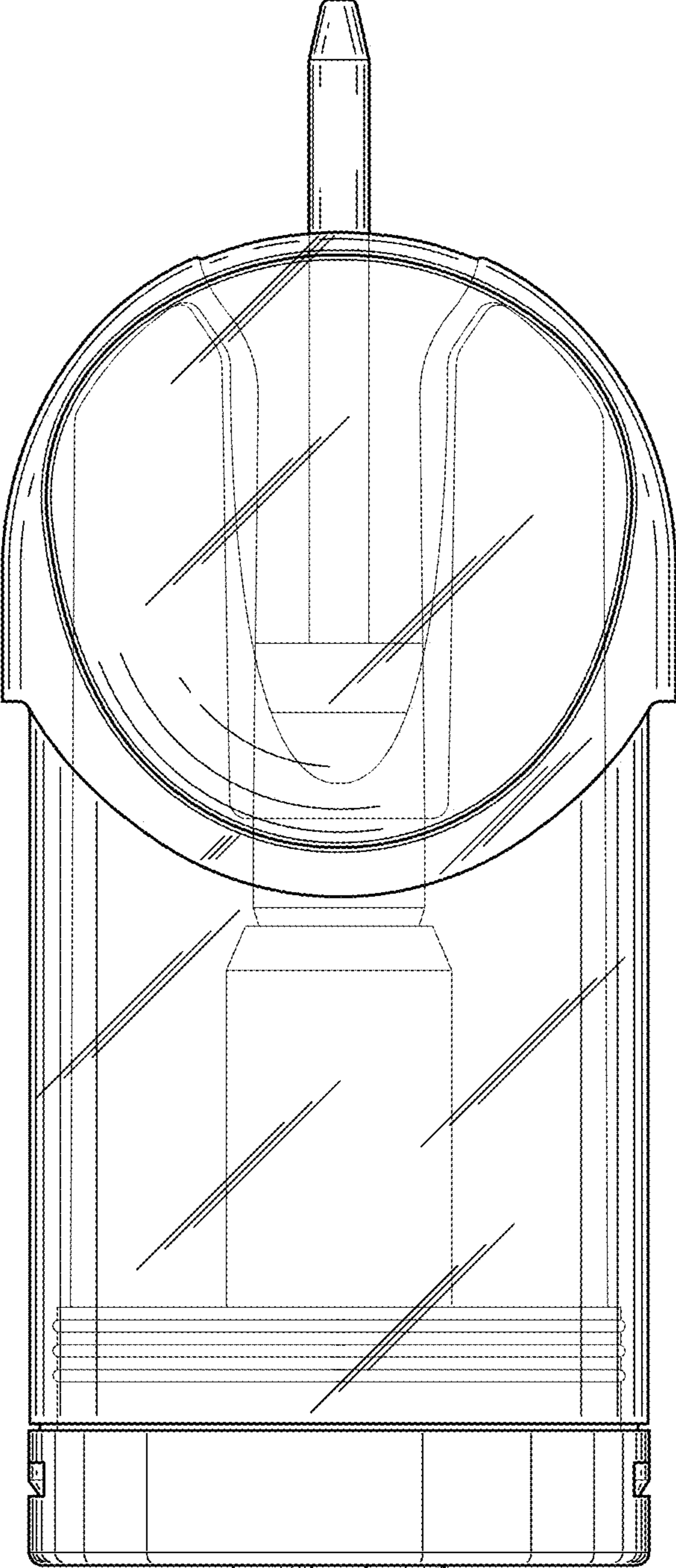

FIG. 1

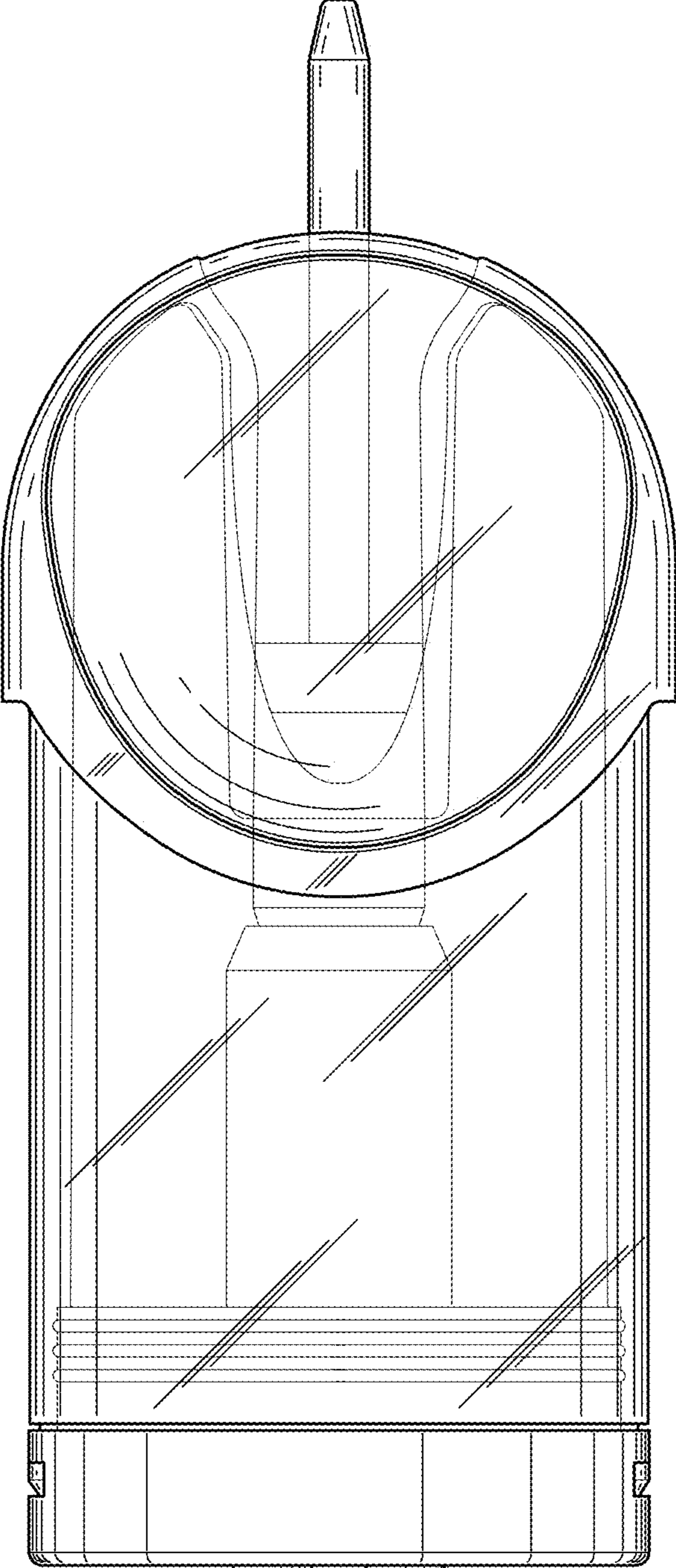

FIG. 2

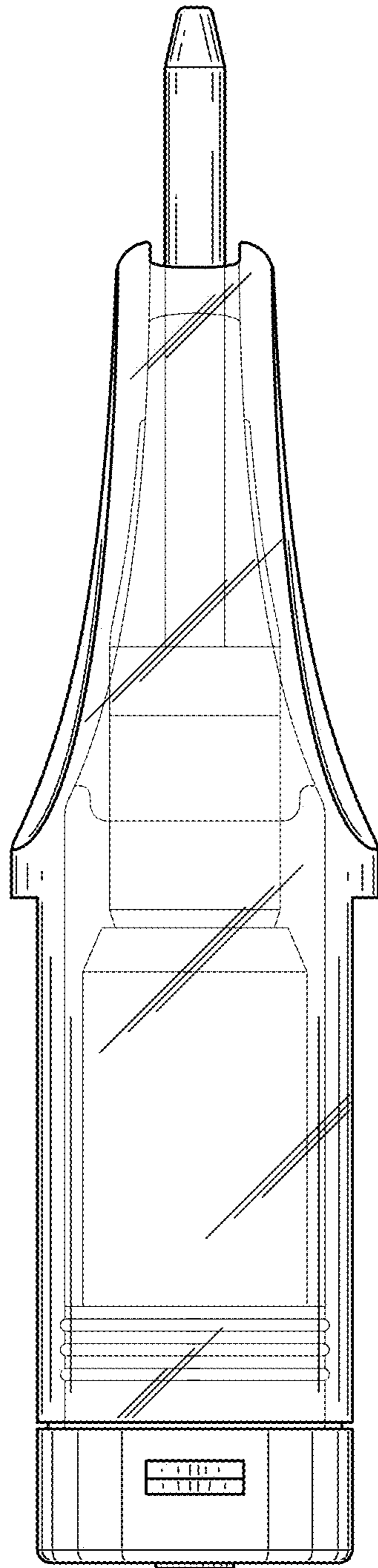

FIG. 3

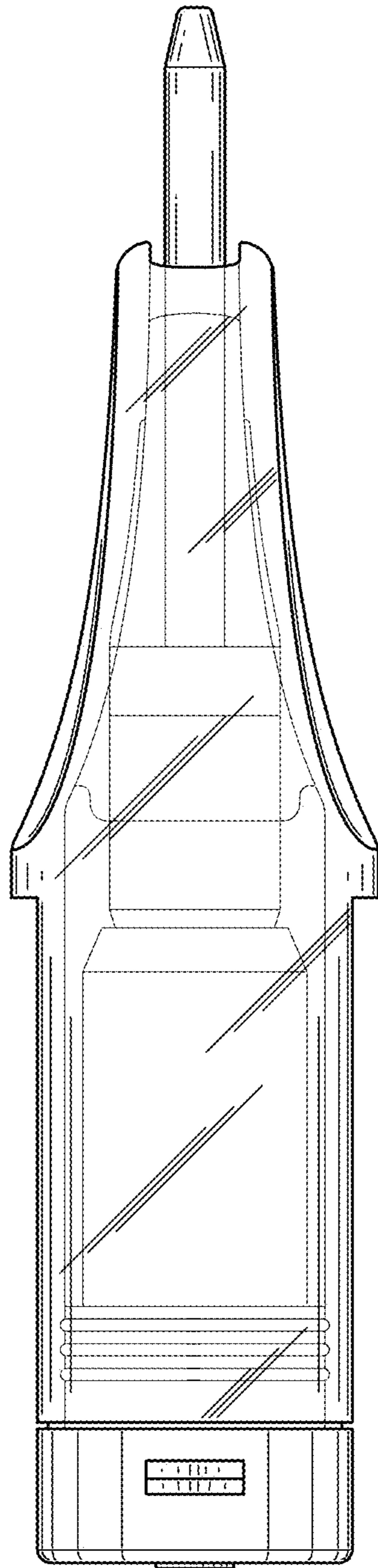

FIG. 4

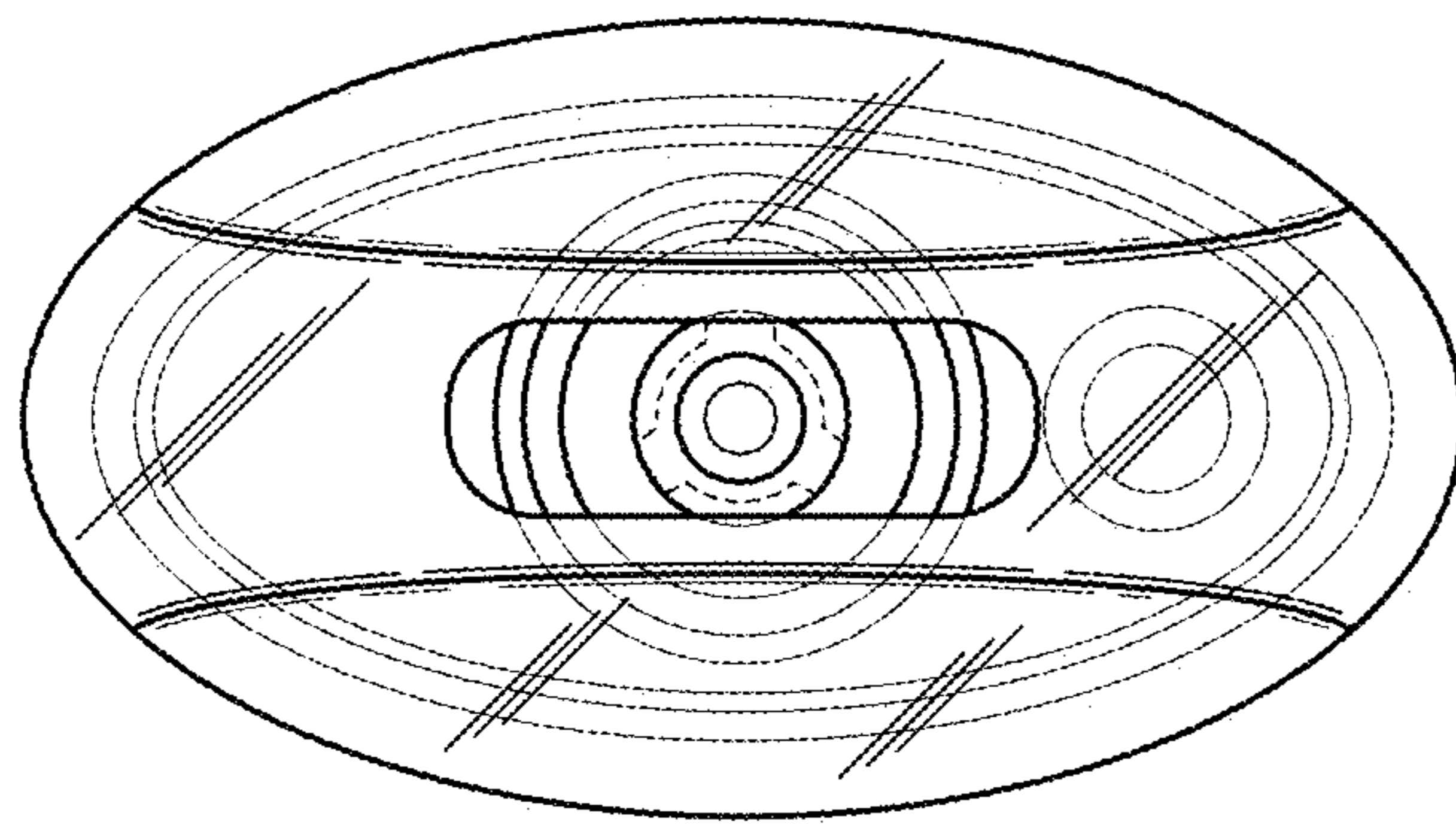

FIG. 5

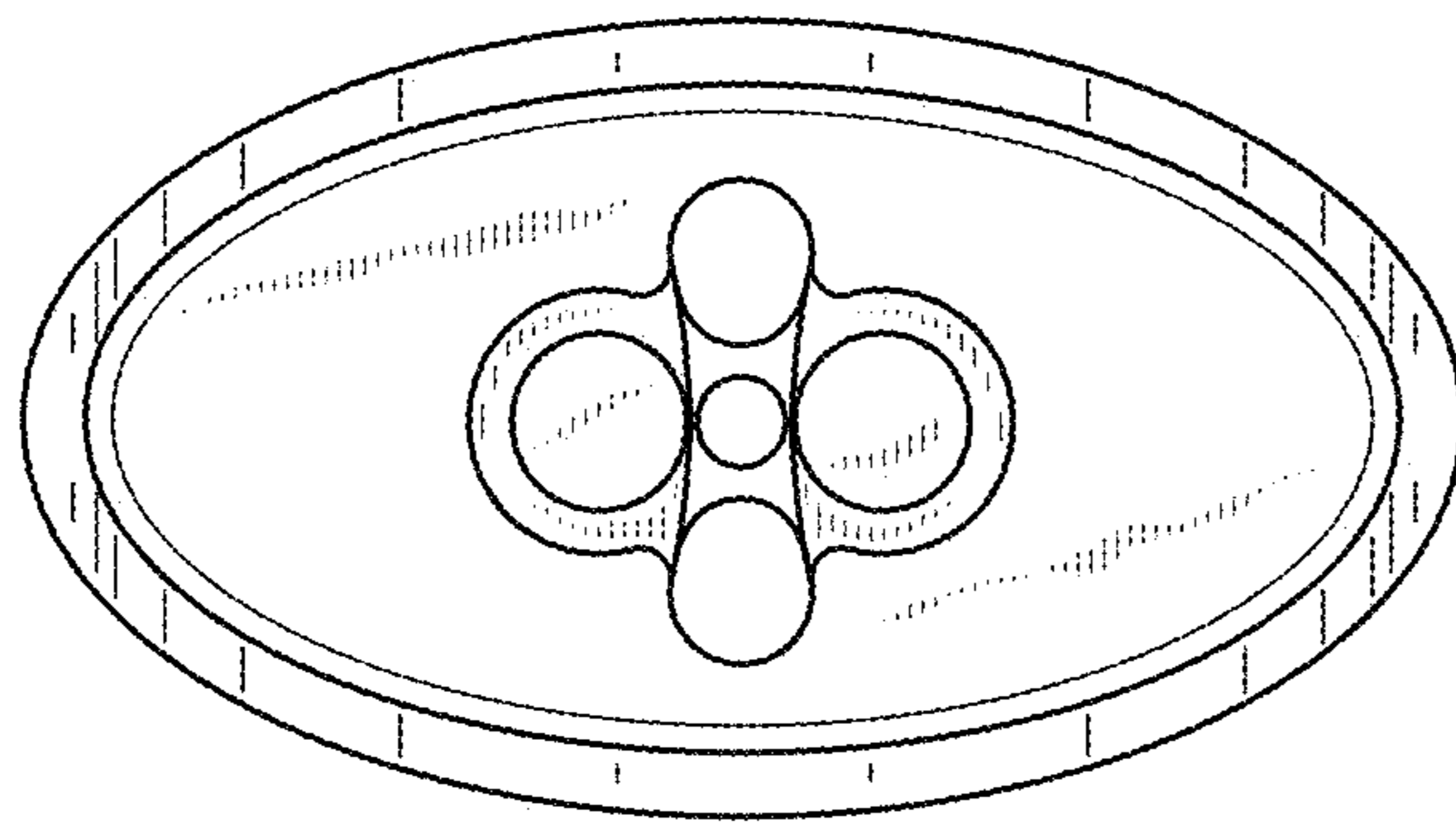

FIG. 6

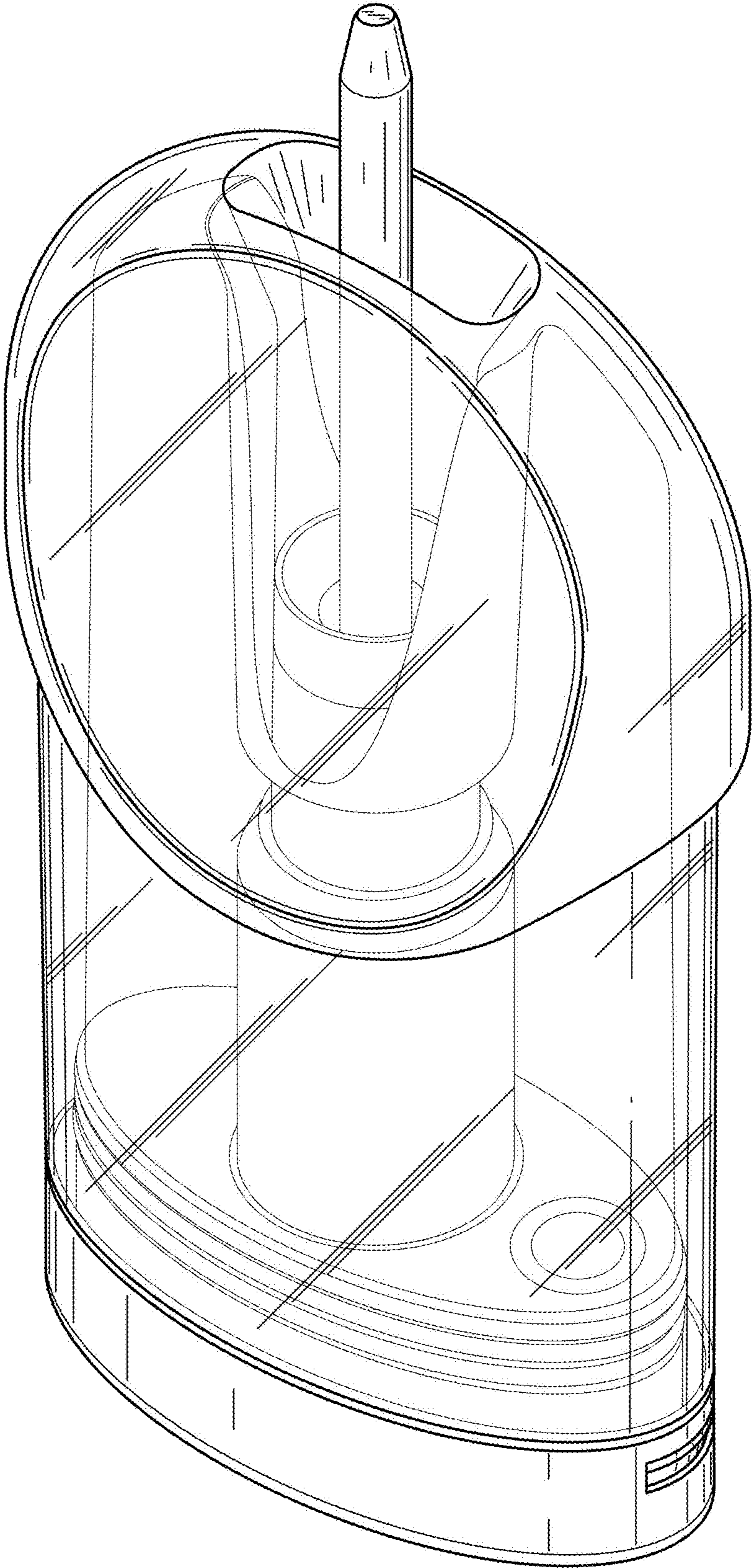

FIG. 7

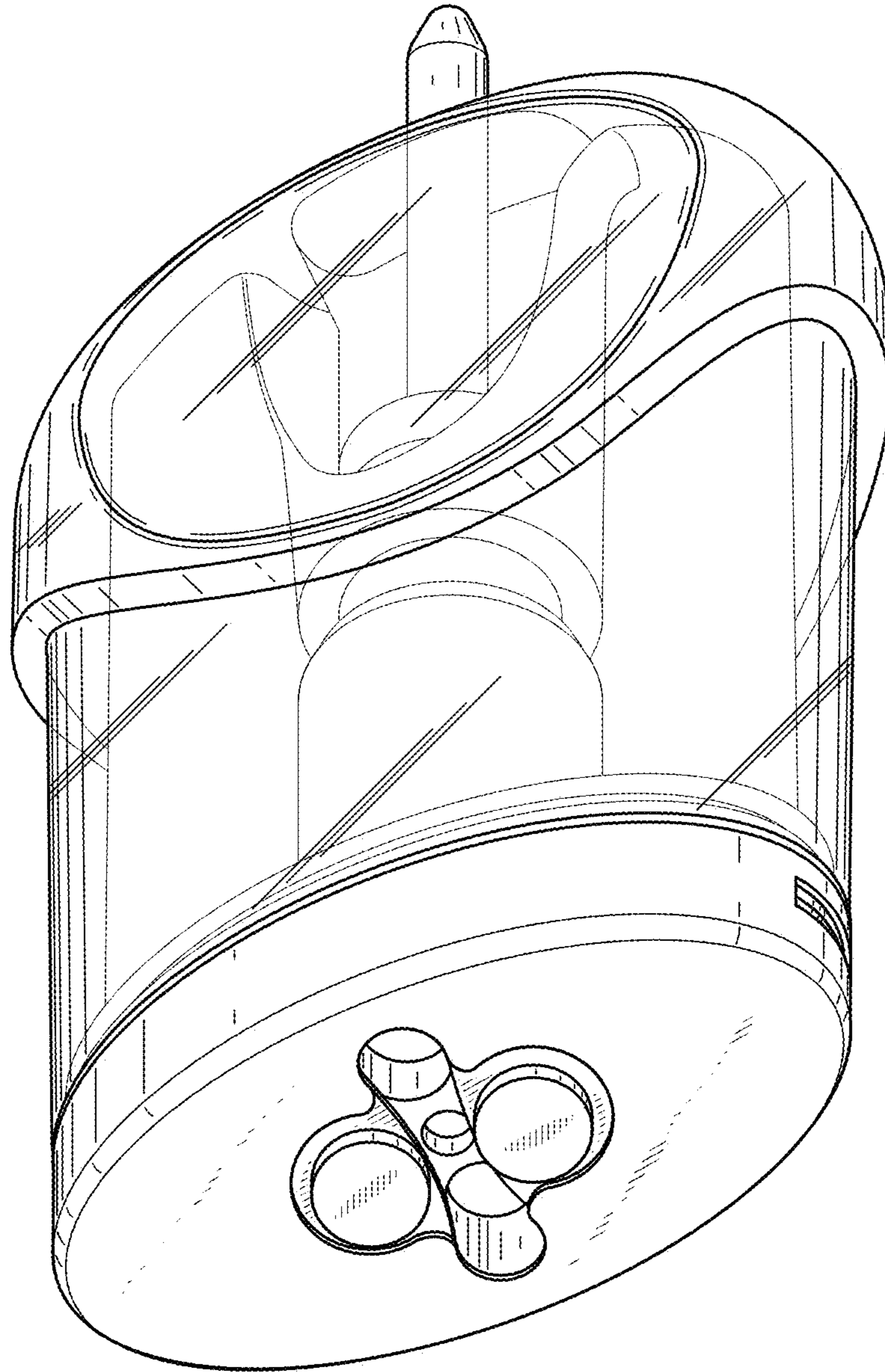

FIG. 8