

US00D957018S

(12) **United States Design Patent** (10) **Patent No.:** **US D957,018 S**
Chen et al. (45) **Date of Patent:** **** Jul. 5, 2022**

(54) **FLASHLIGHT** D812,178 S * 3/2018 Galli D22/108
D907,267 S * 1/2021 Worman D26/60
(71) Applicant: **SHENZHEN YINGLU** D913,553 S * 3/2021 Worman D26/60
TECHNOLOGY DEVELOPMENT D913,554 S * 3/2021 Worman D26/60
CO., LTD, Shenzhen (CN) 2015/0159847 A1* 6/2015 Galli F21V 23/0414
362/111
2019/0154243 A1* 5/2019 Worman F21V 7/0075
(72) Inventors: **Guozheng Chen, Shenzhen (CN);** 2020/0063949 A1* 2/2020 Worman F21V 23/0421
Bilan Pan, Shenzhen (CN) 2021/0025568 A1* 1/2021 Worman F21V 17/002
2021/0140743 A1* 5/2021 Chen F41G 11/003

(73) Assignee: **SHENZHEN YINGLU**
TECHNOLOGY DEVELOPMENT
CO., LTD, Shenzhen (CN)

(**) Term: **15 Years**

(21) Appl. No.: **29/733,701**

(22) Filed: **May 6, 2020**

(51) **LOC (13) Cl.** **26-05**

(52) **U.S. Cl.**
USPC **D26/60; D22/108**

(58) **Field of Classification Search**
USPC D26/24, 37-52, 60, 113, 118-119, 138
CPC ... F21Y 2115/10; F21Y 2101/00; F21L 4/027;
F21L 15/14; F21V 23/0414; F21V
21/0965; F21V 21/145; F21V 21/08;
F21V 33/0064; F21V 21/14; F21V
23/0407; Y10S 362/80; F41G 1/35; F41G
11/003; F41G 1/34; F41G 1/345; F41G
1/36; F41G 11/001; F41G 11/004; F41G
3/00; F41G 1/02; F41G 1/40; F41G 1/467
See application file for complete search history.

(56) **References Cited**

U.S. PATENT DOCUMENTS

D435,676 S * 12/2000 Squillante D26/37
D568,508 S * 5/2008 Howe D26/38

* cited by examiner

Primary Examiner — Marissa J Cash

Assistant Examiner — William B Melliar

(74) *Attorney, Agent, or Firm* — Georgi Korobanov

(57) **CLAIM**

The ornamental design for a flashlight, as shown and described.

DESCRIPTION

FIG. 1 is a perspective view of a flashlight showing my new design;
FIG. 2 is another perspective view thereof;
FIG. 3 is a front elevational view thereof;
FIG. 4 is a rear elevational view thereof;
FIG. 5 is a left side elevational view thereof;
FIG. 6 is a right side elevational view thereof;
FIG. 7 is a top plan view thereof; and,
FIG. 8 is a bottom plan view thereof.
The broken lines in the drawings depict portions of the flashlight that form no part of the claimed design.

1 Claim, 8 Drawing Sheets

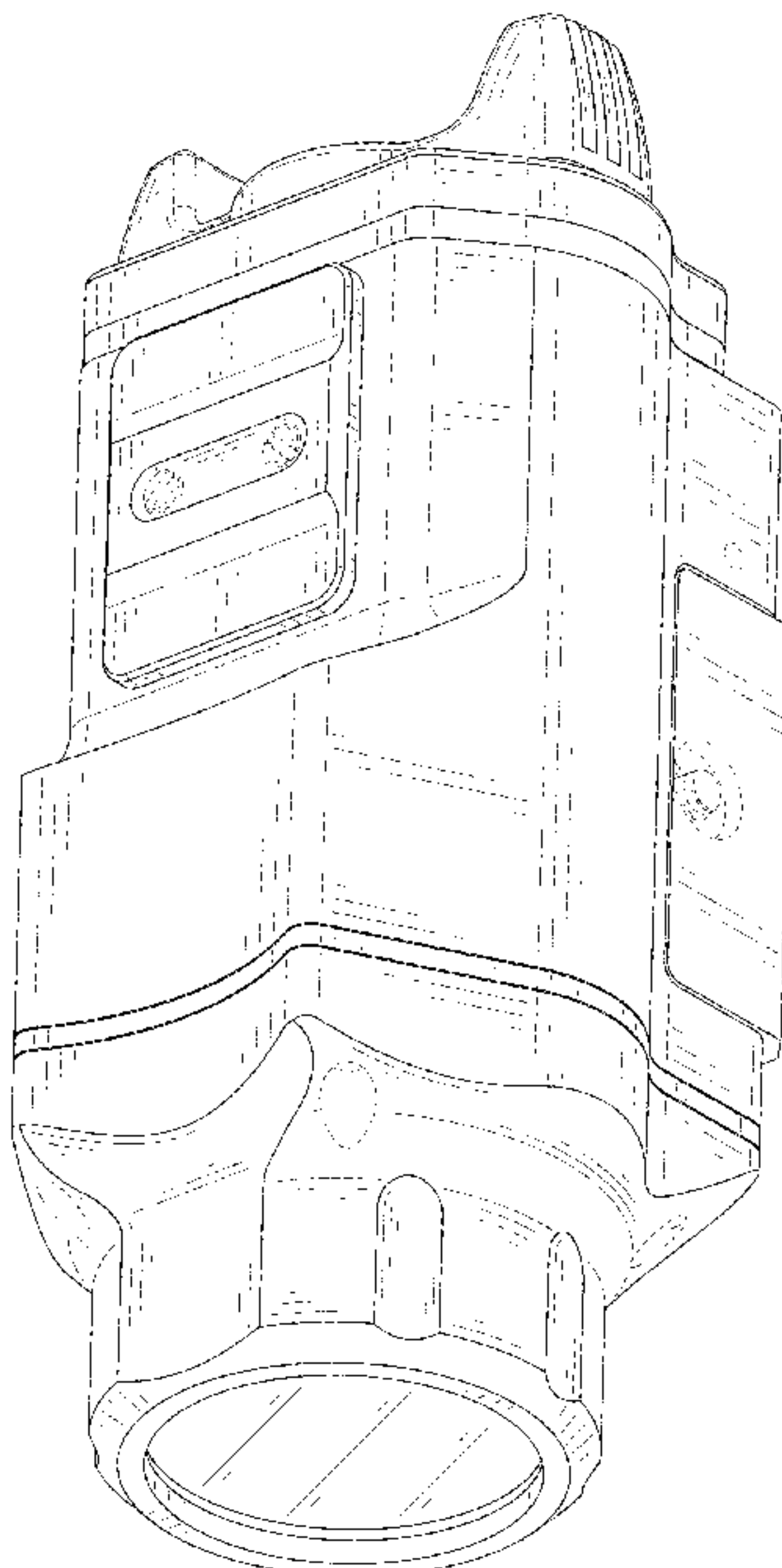

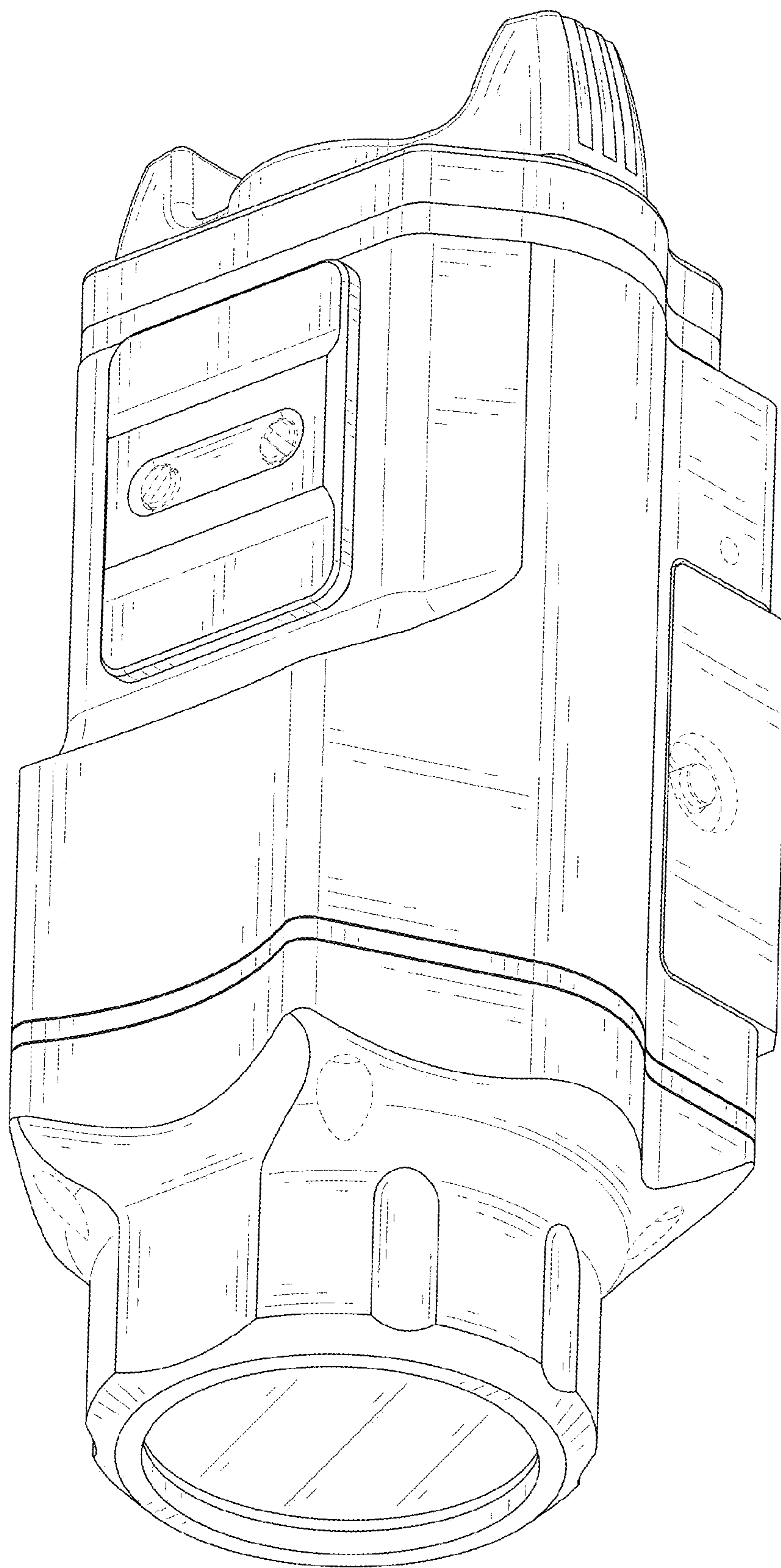

FIG. 1

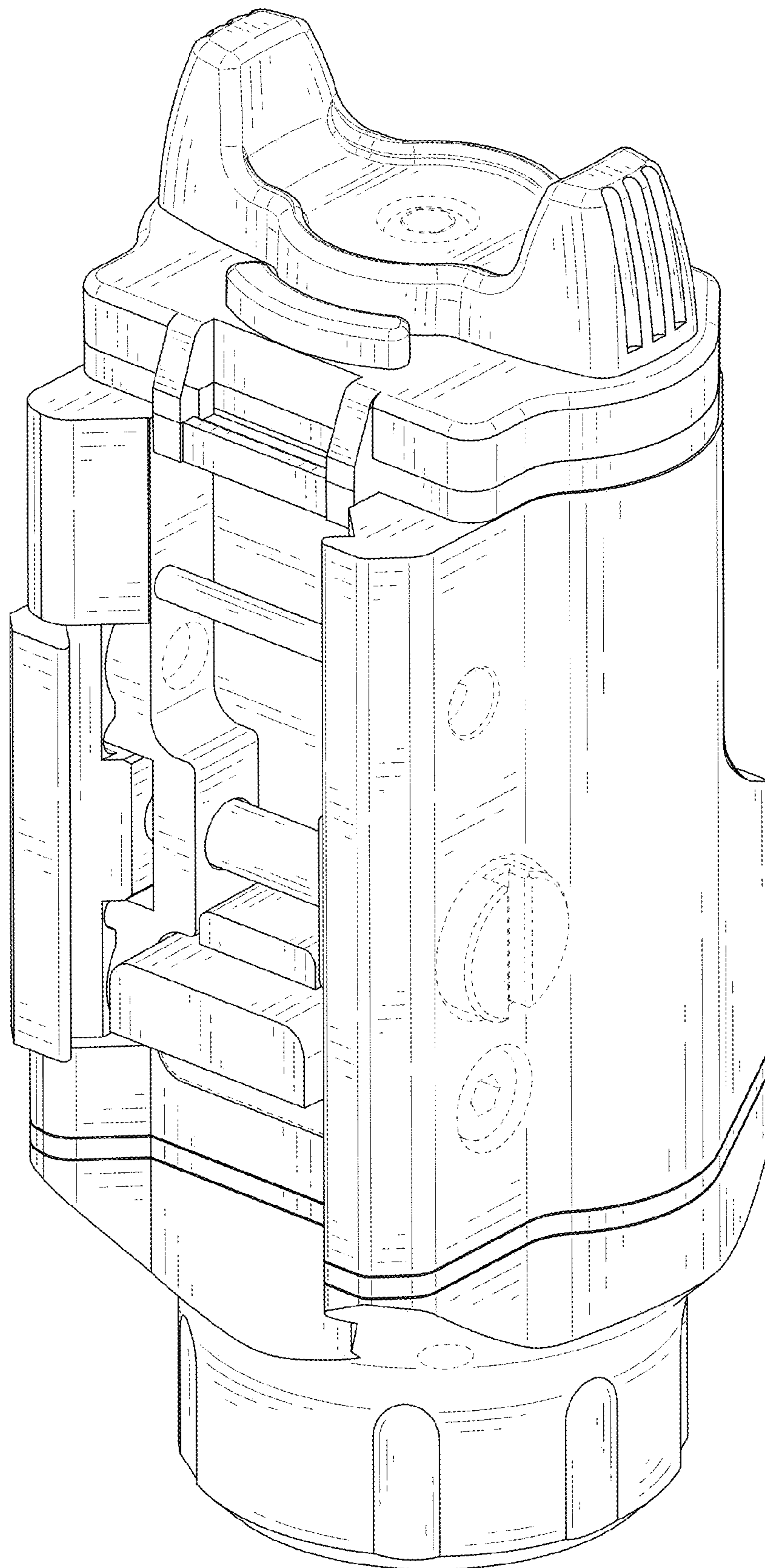

FIG. 2

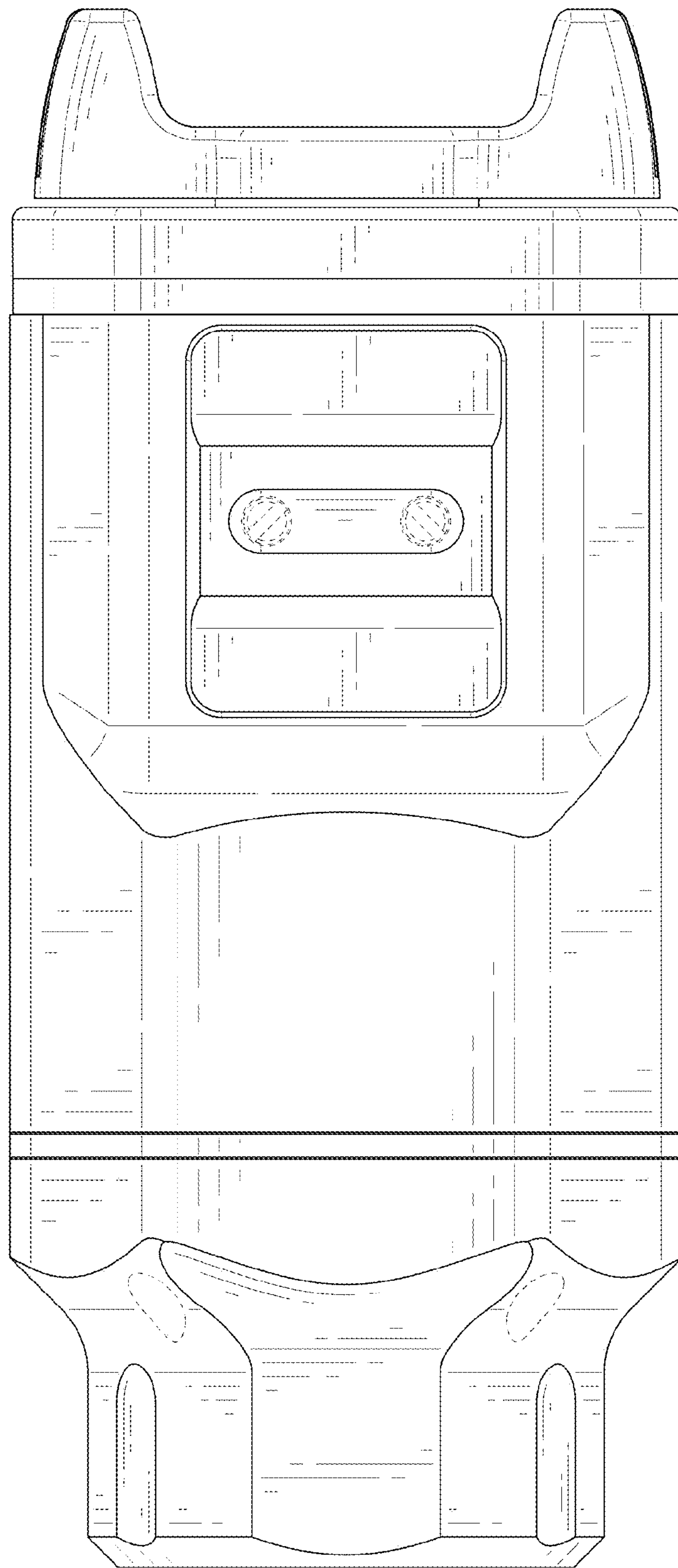

FIG. 3

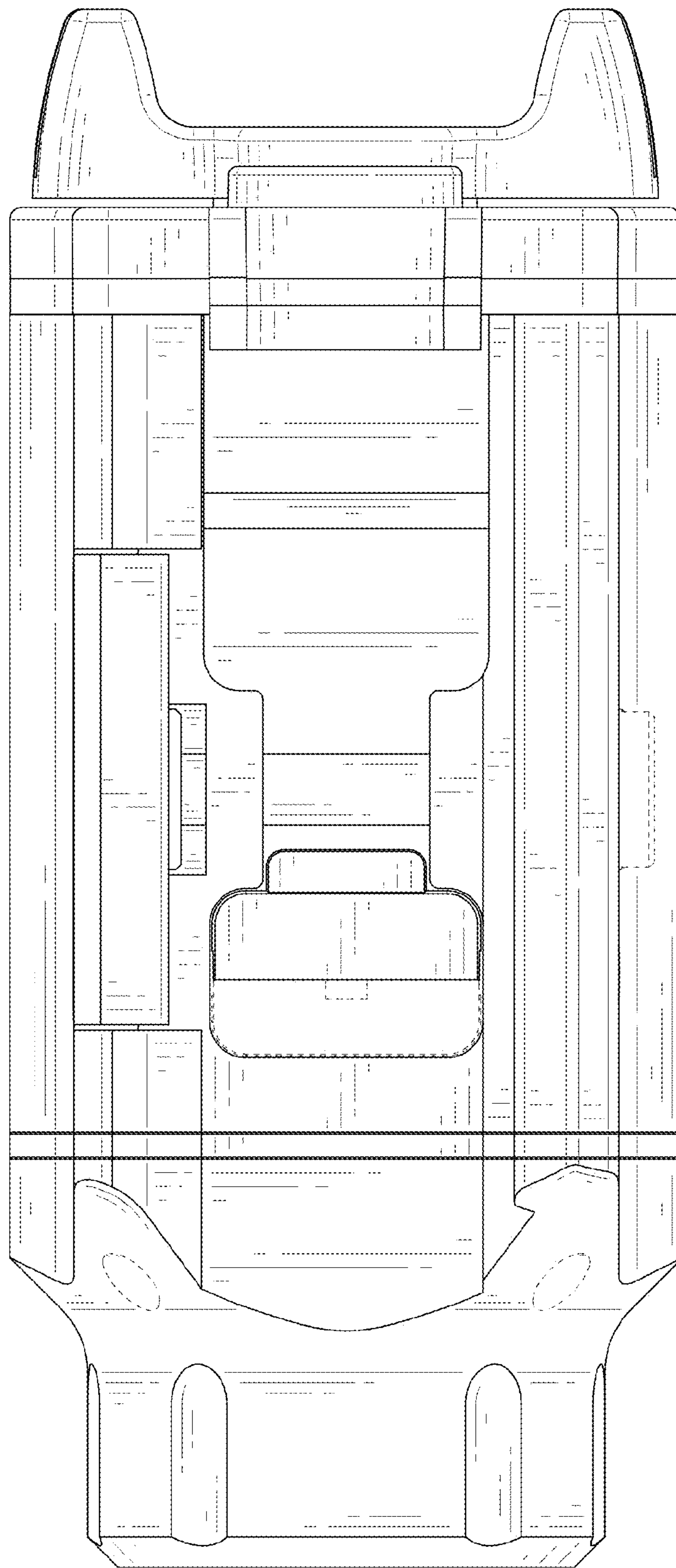

FIG. 4

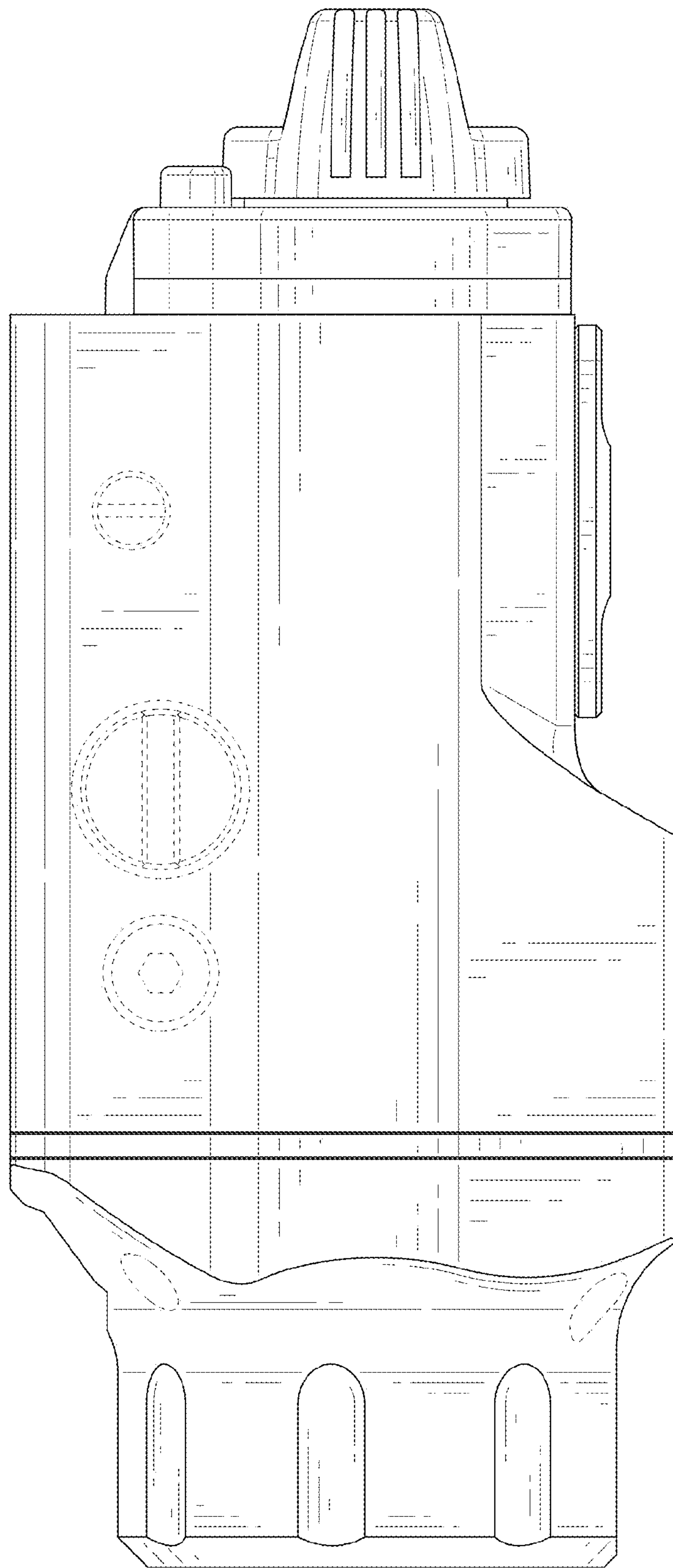

FIG. 5

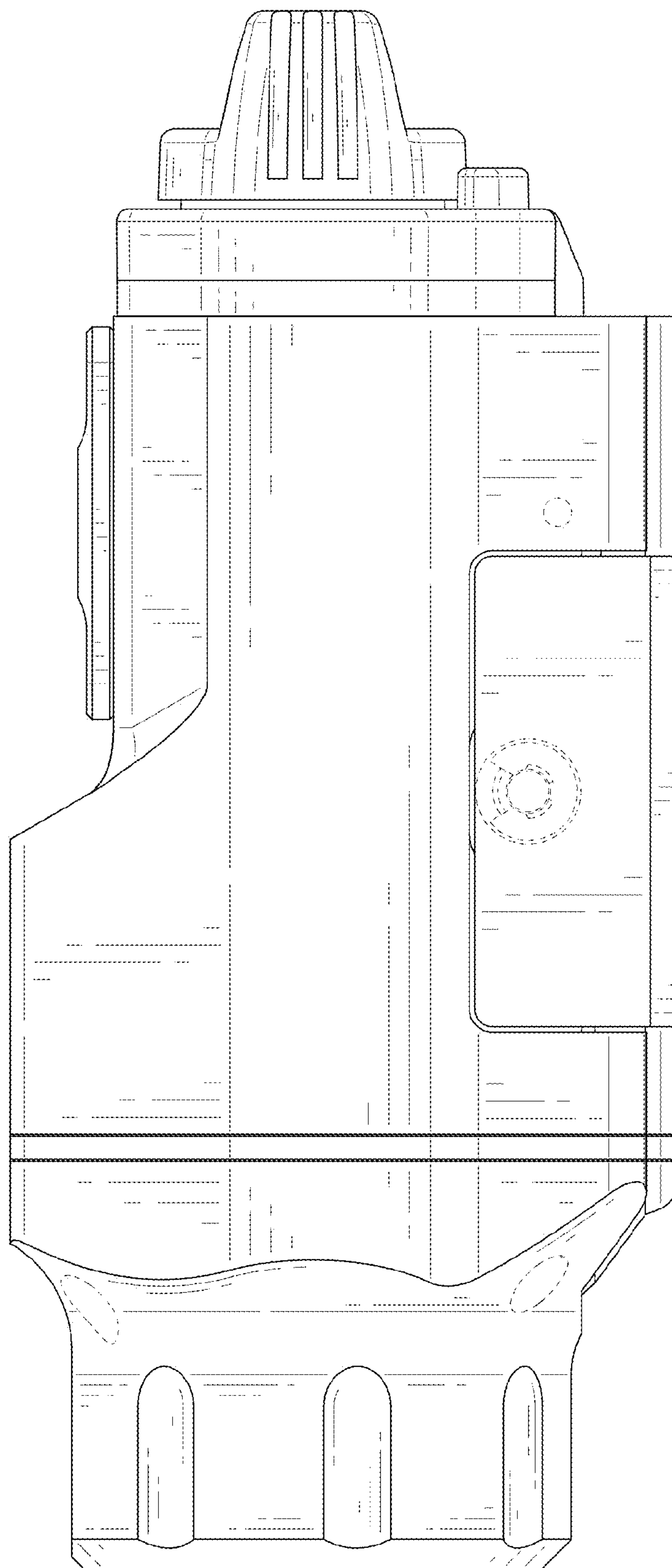

FIG. 6

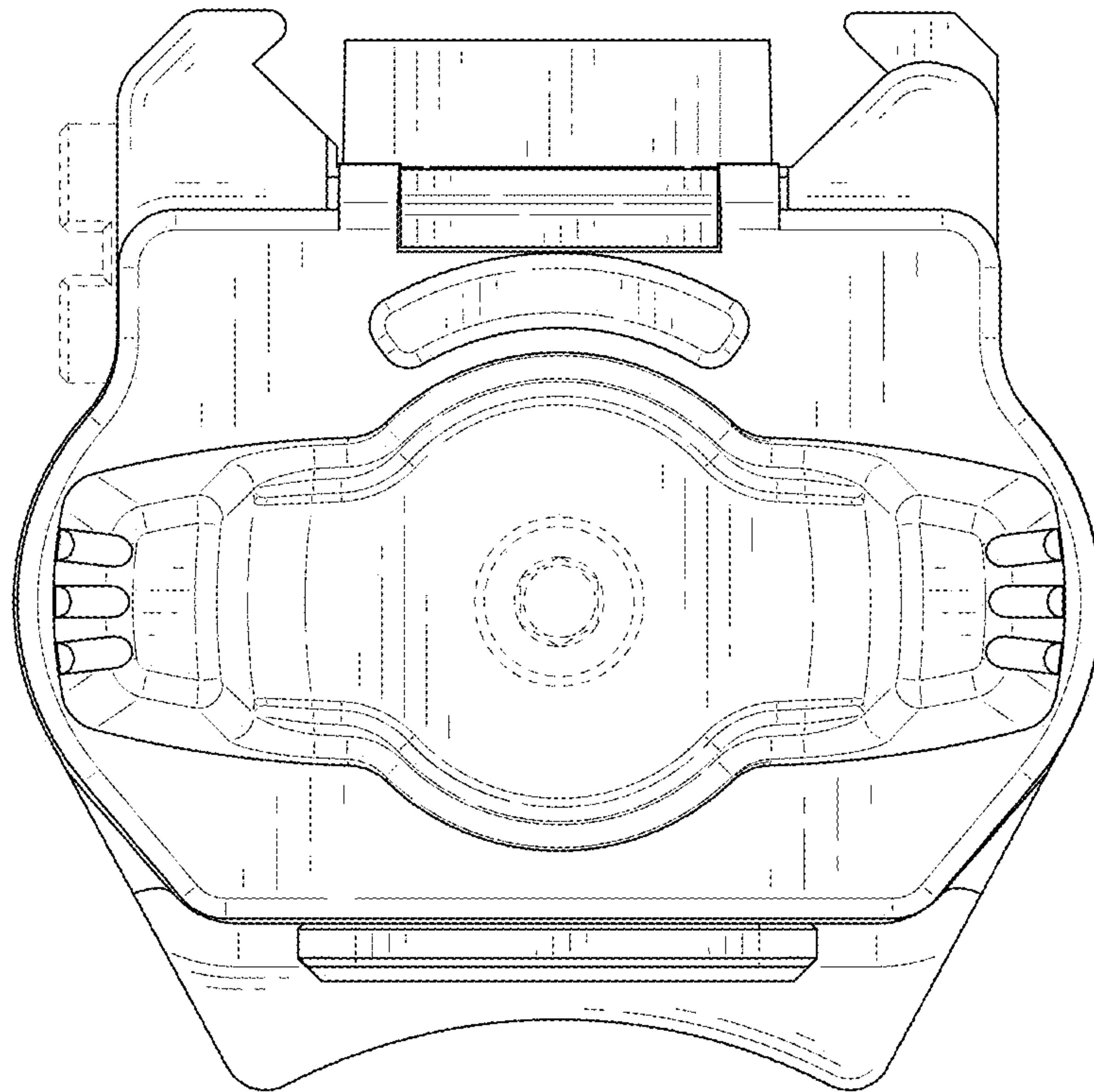

FIG. 7

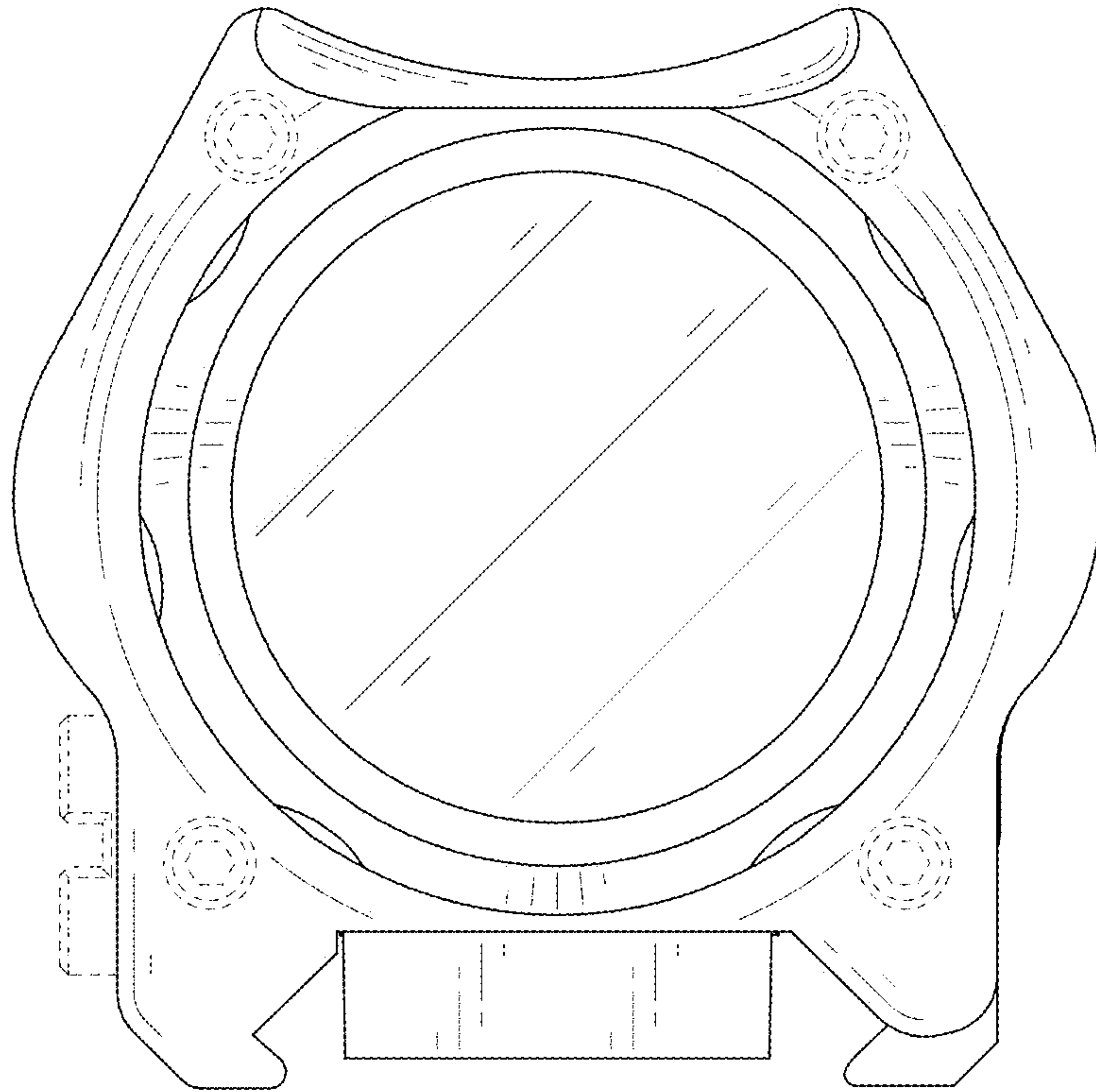

FIG. 8