



US00D956955S

(12) **United States Design Patent** (10) **Patent No.:** **US D956,955 S**
Trebino (45) **Date of Patent:** **** Jul. 5, 2022**

- (54) **FACE MASK**
- (71) Applicant: **Andrew Trebino**, Carlisle, MA (US)
- (72) Inventor: **Andrew Trebino**, Carlisle, MA (US)
- (73) Assignee: **WOLF ROCK DESIGN LLC**,
Carlisle, MA (US)
- (**) Term: **15 Years**
- (21) Appl. No.: **29/741,761**
- (22) Filed: **Jul. 15, 2020**
- (51) **LOC (13) Cl.** **29-02**
- (52) **U.S. Cl.**
USPC **D24/110.1; D29/108**
- (58) **Field of Classification Search**
USPC D24/110.1; D29/108
CPC . A41D 13/11; A41D 13/1107; A41D 13/1115;
A41D 13/1123; A41D 13/113; A41D
13/1138; A41D 13/1146; A41D 13/1153;
A41D 13/1161; A41D 13/1169; A41D
13/1176; A61M 16/06; A62B 18/00;
A62B 18/02; A62B 18/025; A62B 23/00
See application file for complete search history.

2021/0352976 A1* 11/2021 Law A41D 13/1161
 2021/0353981 A1* 11/2021 Gray, III B01D 39/1692
 2022/0000196 A1* 1/2022 Trebino A41D 15/04
 2022/0030970 A1* 2/2022 Pole A41D 13/1161

FOREIGN PATENT DOCUMENTS

GB 6103118 * 10/2020
 KR 20170003790 U 11/2017

OTHER PUBLICATIONS

Wristable (avaialble [online]) Retrieved from the internet Feb. 10,
 2022, URL: <https://www.etsy.com/listing/914282505/wristable-the-face-mask-wristband> (Year: 2022).*

(Continued)

Primary Examiner — Richard Kearney
Assistant Examiner — Michael Hoffman

(57) **CLAIM**

The ornamental design for a face mask, as shown and described.

DESCRIPTION

FIG. 1 is a front perspective view of a face mask showing my new design;
 FIG. 2 is a rear perspective view thereof;
 FIG. 3 is a front elevational view thereof;
 FIG. 4 is a rear elevational view thereof;
 FIG. 5 is a top plan view thereof, the bottom view being a mirror image thereof;
 FIG. 6 is a right-side elevational view thereof, the left-side elevational view being a mirror image thereof; and,
 FIG. 7 is a front perspective view thereof, wherein the face mask is in its folded state.
 The broken lines showing of ear loops in FIGS. 1-7 are included for the purpose of showing environmental structure and form no part of the claimed design.

1 Claim, 7 Drawing Sheets

(56) **References Cited**

U.S. PATENT DOCUMENTS

D270,110 S * 8/1983 Moore 128/201.15
 D910,929 S * 2/2021 Won D29/108
 2009/0071483 A1* 3/2009 Son A62B 18/025
 128/206.13
 2017/0209719 A1* 7/2017 Tang A62B 23/025
 2018/0000173 A1* 1/2018 Tsauro G10K 11/24
 2020/0305520 A1* 10/2020 Belk A41D 13/1161
 2021/0031061 A1 2/2021 Cooper
 2021/0153575 A1* 5/2021 Hong A41D 13/1161
 2021/0345696 A1* 11/2021 Farshoukh A41D 13/113
 2021/0345713 A1* 11/2021 Yates A41D 13/11

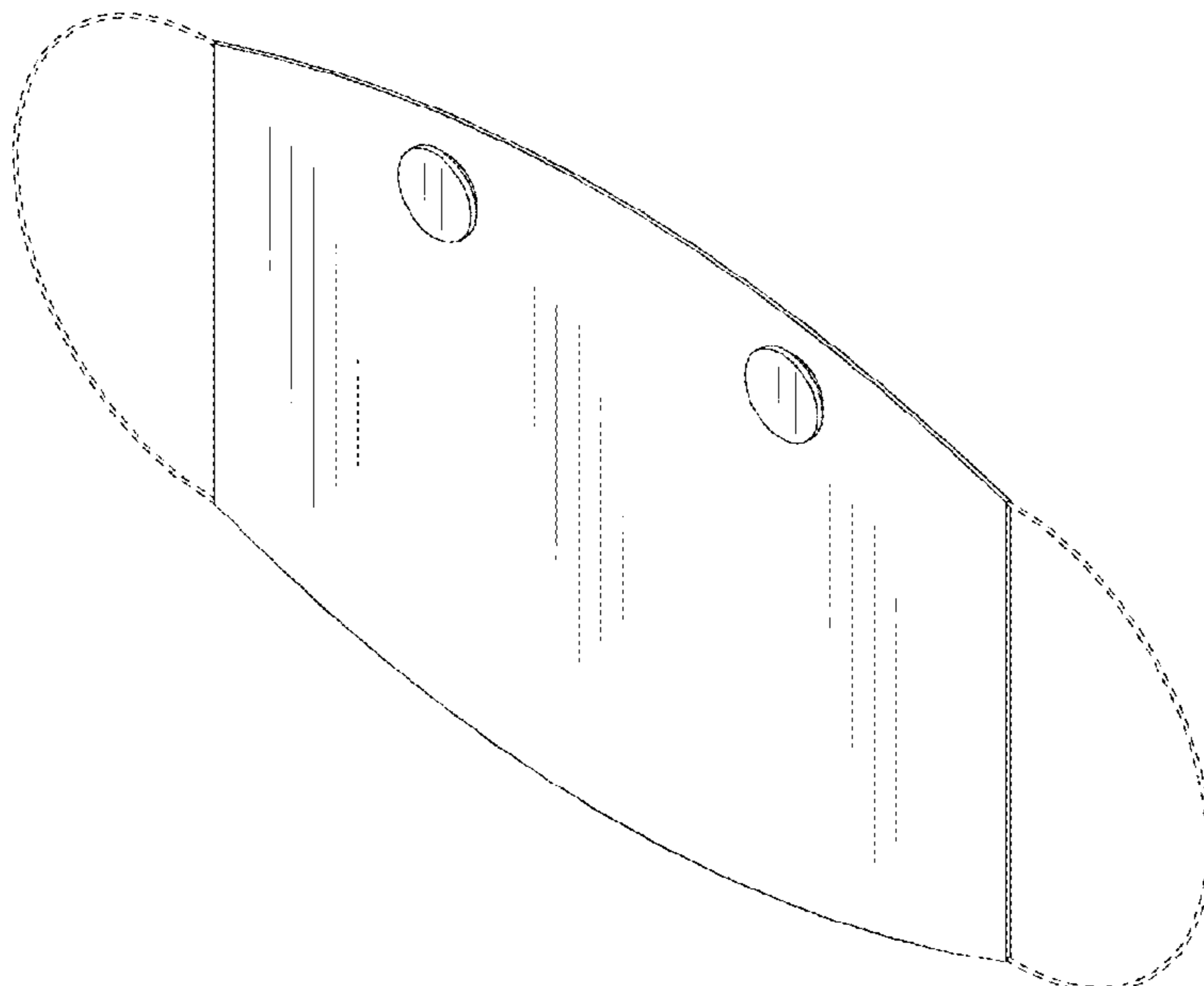

(56)

References Cited

OTHER PUBLICATIONS

Slapmask (available online] Sep. 9, 2021) Retrieved from the internet Feb. 11, 2022, URL: https://www.amazon.com/Slapmask-Face_masks-Reusable-Face_Mask-Adjustable/dp/B09FSJM6R8/ (Year: 2021).*

Anjurisa, “Consider This When Making A Face Mask at Home— Fabric Face Mask with Buttons,” <URL: <https://www.youtube.com/watch?v=xtsCc28rJNU>>.

Merrill, “Carlisle Man Develops Face Mask Bracelet So You Never Forget It,” <URL: <https://boston.cbslocal.com/2020/10/15/handy-band-face-masks-bracelets-carlisle-massachusetts-andrew-trebino/>>.

Nied, “What Are Slapmasks And Will They Protect You Against COVID-19? Experts Explain,” <URL: <https://www.womenshealthmag.com/health/a34934223/slap-masks-safety/>>.

* cited by examiner

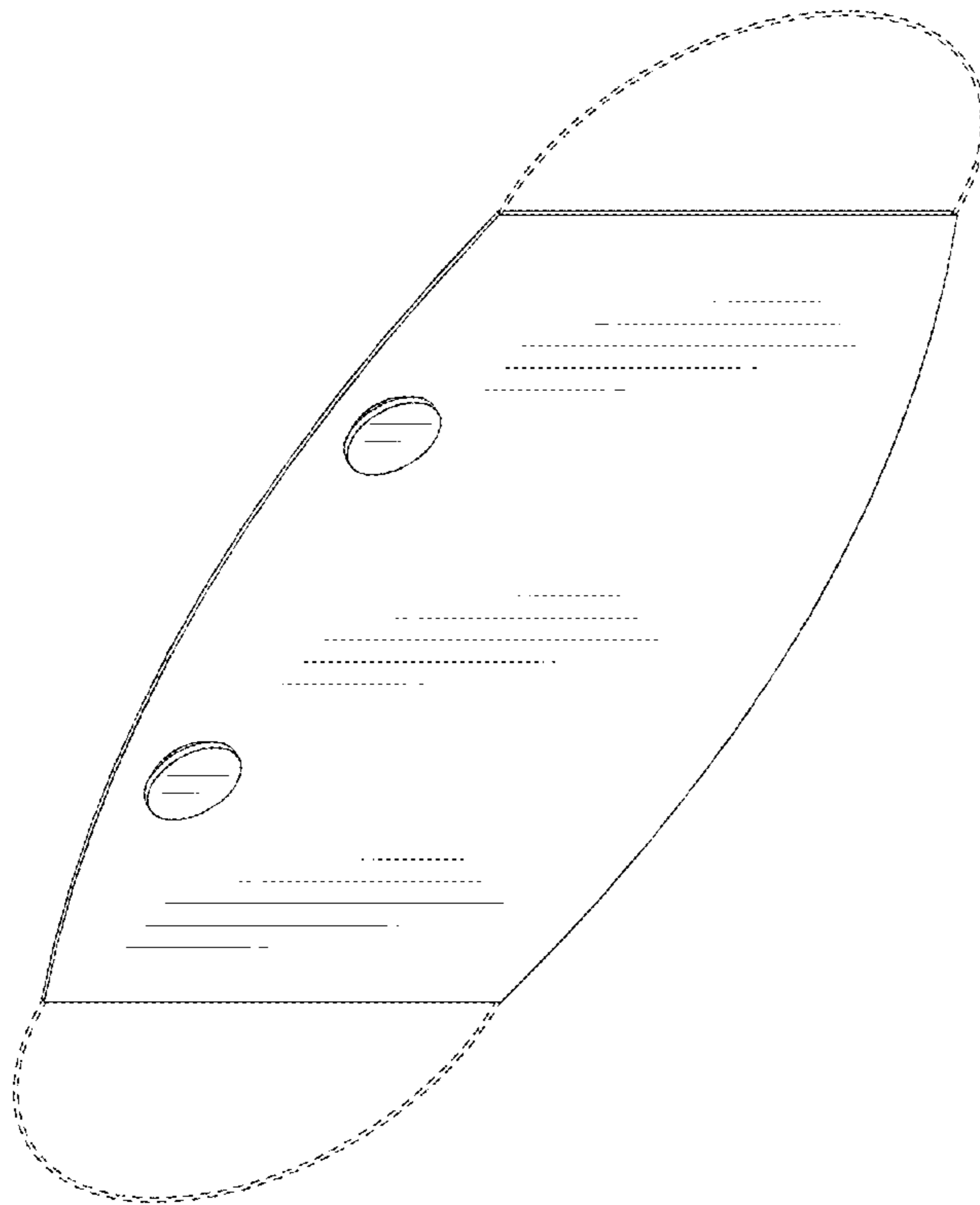

FIG. 1

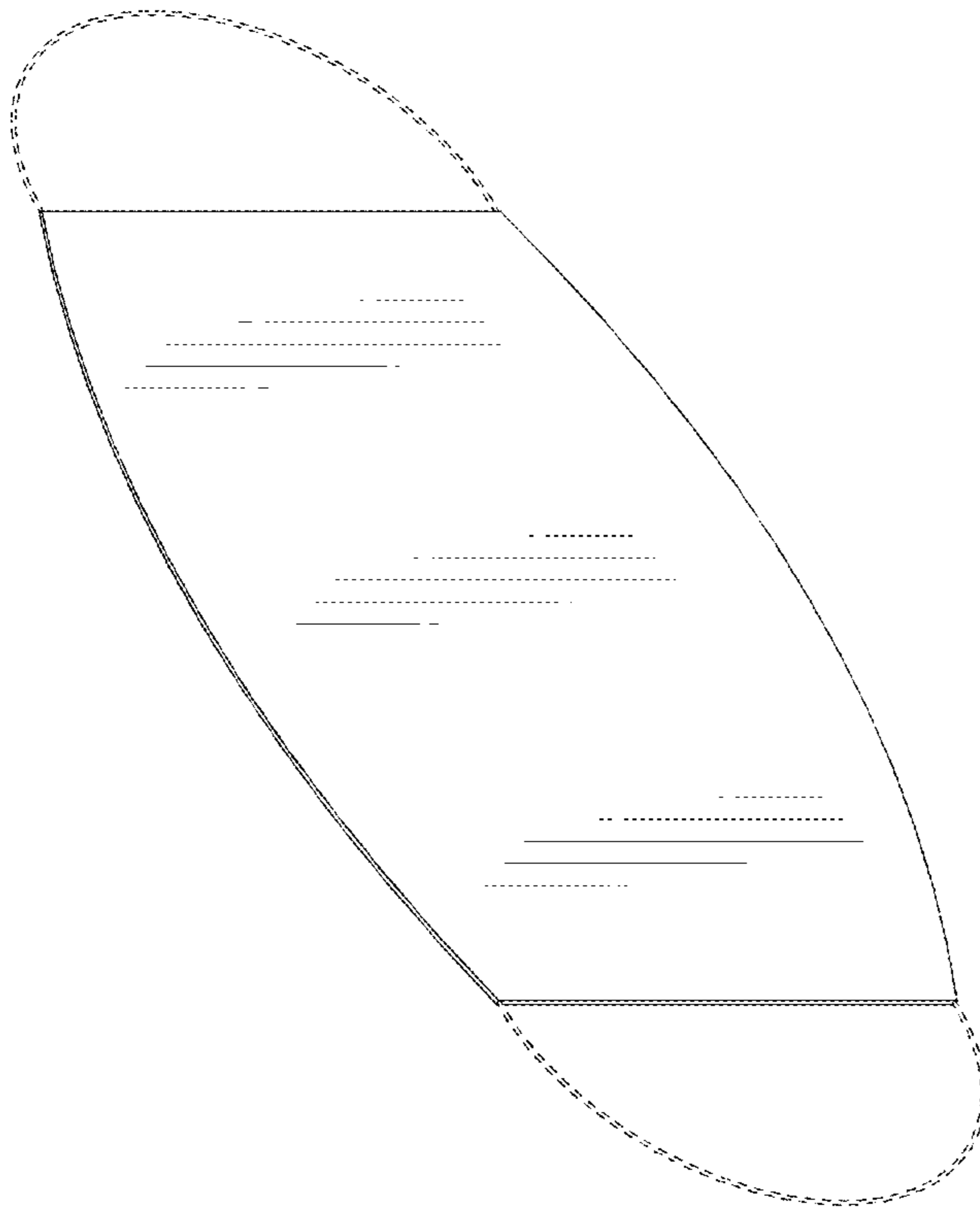

FIG. 2

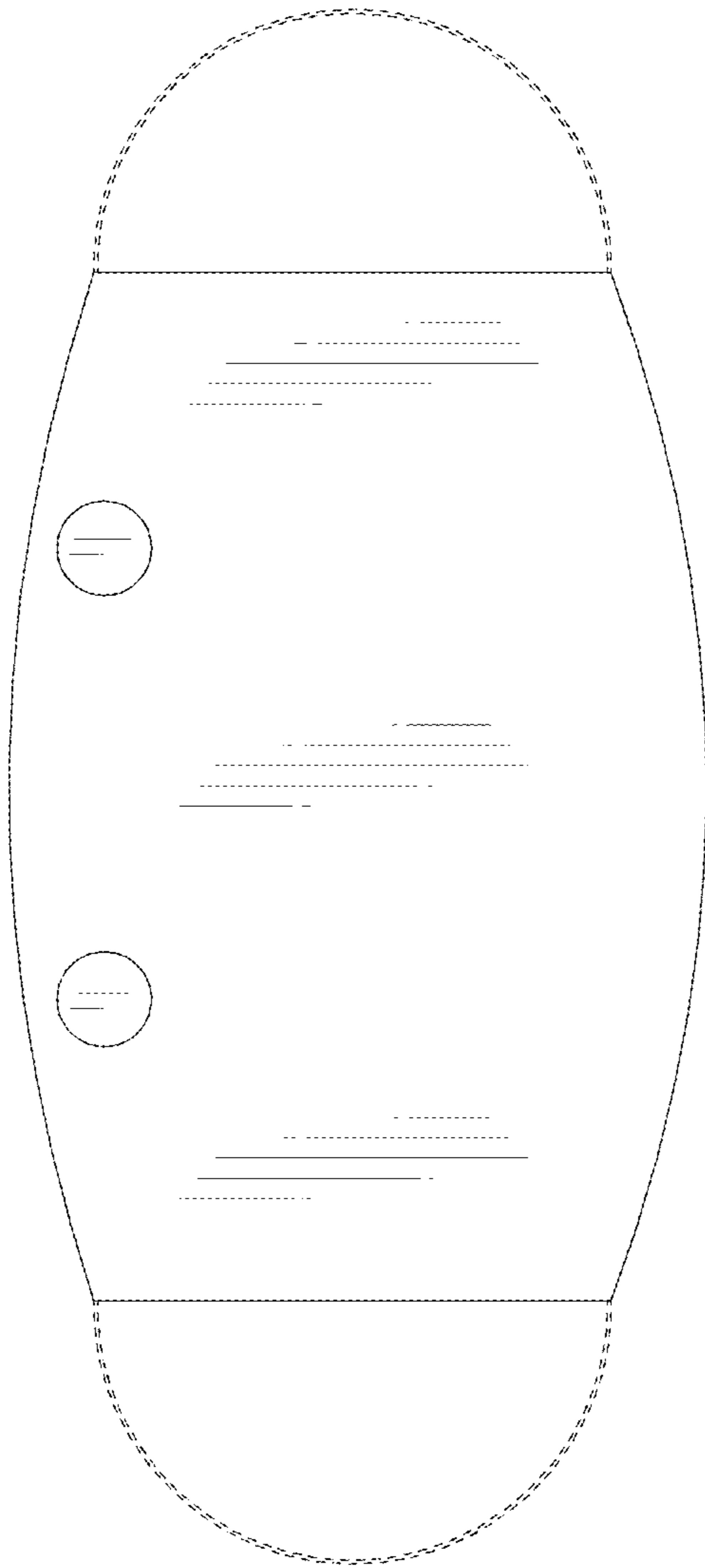

FIG. 3

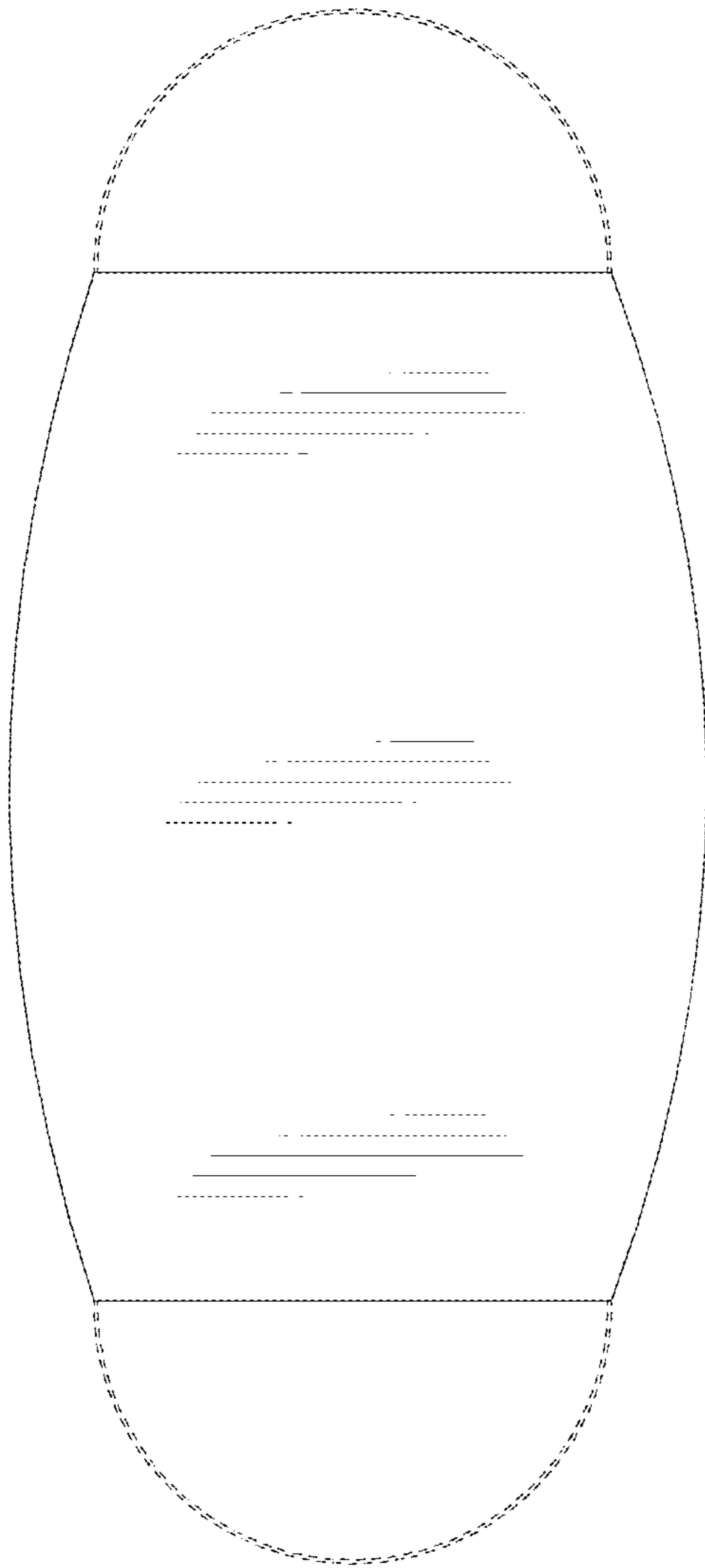

FIG. 4

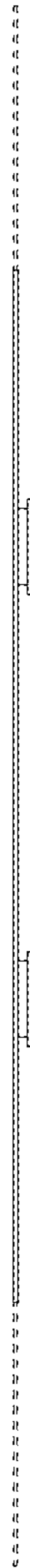

FIG. 5

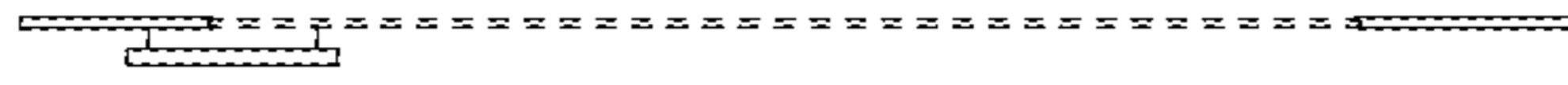

FIG. 6

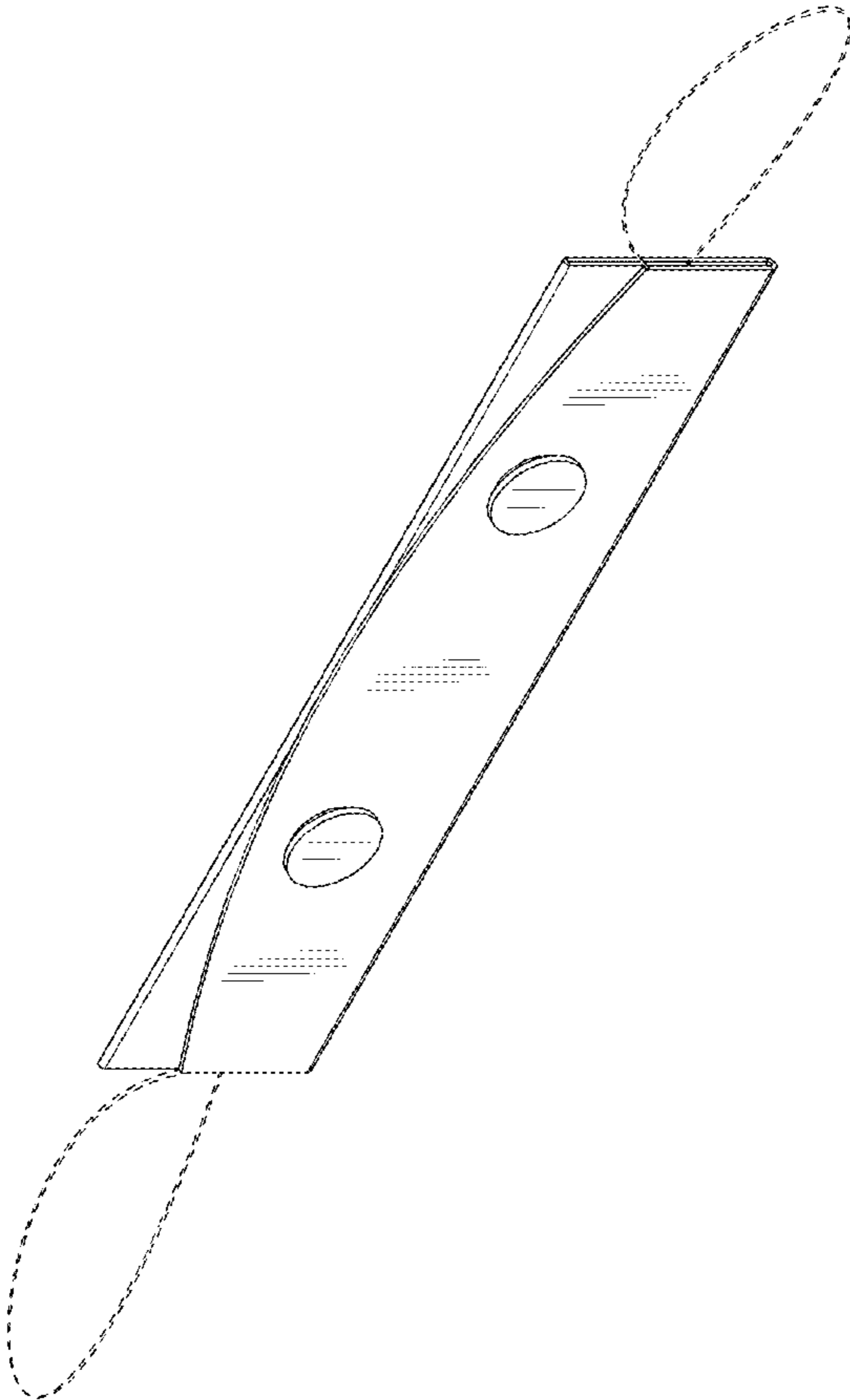

FIG. 7