



US00D956937S

(12) **United States Design Patent**  
**DeWitt et al.**

(10) **Patent No.:** **US D956,937 S**

(45) **Date of Patent:** **\*\* Jul. 5, 2022**

(54) **PIPE COUPLING ASSEMBLY**

(71) Applicant: **Fernco, Inc.**, Davison, MI (US)

(72) Inventors: **Donald James DeWitt**, Davison, MI (US); **Anthony John Dipzinski**, Grand Blanc, MI (US)

(73) Assignee: **FERNCO, INC.**, Davison, MI (US)

(\*\*) Term: **15 Years**

(21) Appl. No.: **29/709,549**

(22) Filed: **Oct. 15, 2019**

**Related U.S. Application Data**

(63) Continuation-in-part of application No. 16/601,243, filed on Oct. 14, 2019, now Pat. No. 11,193,611.

(51) **LOC (13) Cl.** ..... **23-01**

(52) **U.S. Cl.**  
USPC ..... **D23/262; D23/265**

(58) **Field of Classification Search**  
USPC ..... **D23/259, 262, 264-266, 269, 396**  
(Continued)

(56) **References Cited**

**U.S. PATENT DOCUMENTS**

3,233,922 A \* 2/1966 Evans ..... F16L 21/005  
24/19  
3,837,683 A \* 9/1974 Taylor ..... F16L 21/005  
285/259

(Continued)

**OTHER PUBLICATIONS**

Fernco No-Hub Couplings Price Sheet; Internet Archive WayBack date May 6, 2021; Visited Online Feb. 23, 2022; [https://www.fernco.com/sites/default/files/literature/no-hub\\_NO\\_price\\_T0615\\_0.pdf](https://www.fernco.com/sites/default/files/literature/no-hub_NO_price_T0615_0.pdf) (Year: 2021).\*

(Continued)

*Primary Examiner* — Amy C Wierenga

(74) *Attorney, Agent, or Firm* — Dickinson Wright PLLC

(57) **CLAIM**

We claim the ornamental design for a pipe coupling assembly, as shown and described.

**DESCRIPTION**

FIG. 1 is a perspective view of the pipe coupling assembly according to a first embodiment;

FIG. 2 is a front view of the pipe coupling assembly of FIG. 1;

FIG. 3 is a back view of the pipe coupling assembly of FIG. 1;

FIG. 4 is a top view of the pipe coupling assembly of FIG. 1;

FIG. 5 is a bottom view of the pipe coupling assembly of FIG. 1;

FIG. 6 is a perspective view of the pipe coupling assembly of FIG. 1, showing only the tubular body with the bands removed for ease of viewing;

FIG. 7 is a front view of the tubular body of FIG. 6;

FIG. 8 is a rear view of the tubular body of FIG. 6;

FIG. 9 is a top view of the tubular body of FIG. 6;

FIG. 10 is a bottom view of the tubular body of FIG. 6;

FIG. 11 is a perspective view of the pipe coupling assembly according to a second embodiment;

FIG. 12 is a front view of the pipe coupling assembly of FIG. 11;

FIG. 13 is a back view of the pipe coupling assembly of FIG. 11;

FIG. 14 is a top view of the pipe coupling assembly of FIG. 11; and,

FIG. 15 is a bottom view of the pipe coupling assembly of FIG. 11.

The broken lines shown in the drawings are included for the purpose of illustrating portions of the pipe coupling assembly and form no part of the claimed design.

**1 Claim, 15 Drawing Sheets**

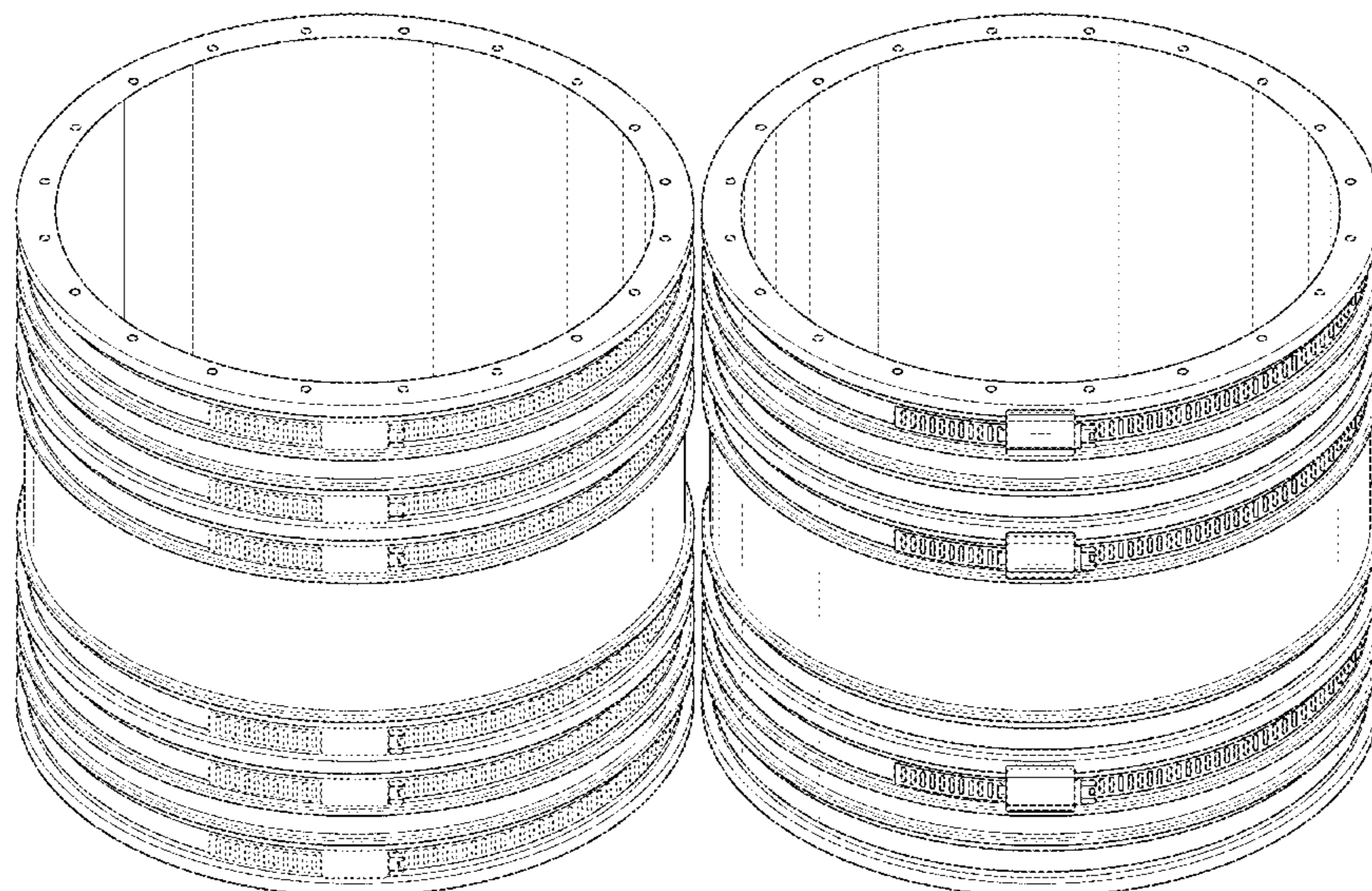

(58) **Field of Classification Search**

CPC ..... F16L 2201/10; F16L 17/025; F16L 21/03  
See application file for complete search history.

(56) **References Cited**

U.S. PATENT DOCUMENTS

4,172,607 A \* 10/1979 Norton ..... F16L 21/005  
285/236  
4,564,220 A \* 1/1986 Sills ..... F16L 21/005  
285/236  
5,193,859 A \* 3/1993 McKinnon ..... B29C 70/26  
285/236  
5,431,458 A \* 7/1995 Schaub ..... F16L 25/14  
285/236  
D371,189 S \* 6/1996 Dharamsi ..... D23/269  
5,630,629 A 5/1997 Moessinger  
D446,298 S \* 8/2001 Thurman ..... D23/262  
7,083,203 B2 8/2006 Glaser et al.  
D574,472 S \* 8/2008 Kanao ..... D23/262  
D589,126 S \* 3/2009 Concannon ..... D23/262  
D609,789 S \* 2/2010 Milnes ..... D23/262  
D723,667 S \* 3/2015 Locke ..... D23/266  
9,765,911 B2 \* 9/2017 Kenney ..... F16L 21/005  
11,193,611 B2 \* 12/2021 DeWitt ..... F16L 21/002  
11,193,612 B2 \* 12/2021 O'Neil ..... F16L 21/005  
2014/0197632 A1 \* 7/2014 Hennemann ..... F16L 37/091  
285/319  
2021/0108744 A1 \* 4/2021 DeWitt ..... F16L 25/14

OTHER PUBLICATIONS

Fernco XL Couplings Sales Sheet; Dec. 10, 2018; Visited Online  
Feb. 23, 2022; <https://www.fernco.com/xl-couplings> (Year: 2018).\*

\* cited by examiner

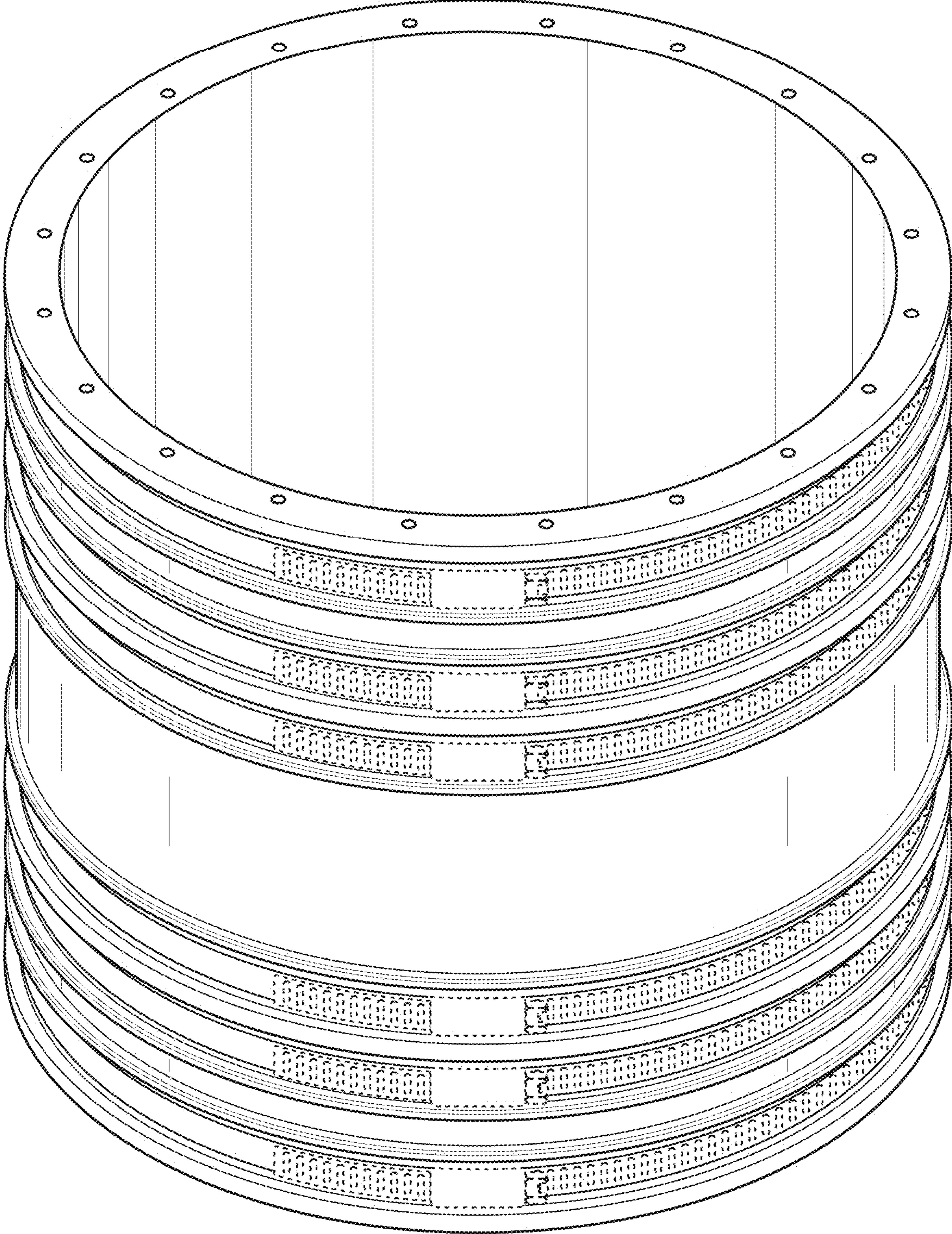

FIG. 1

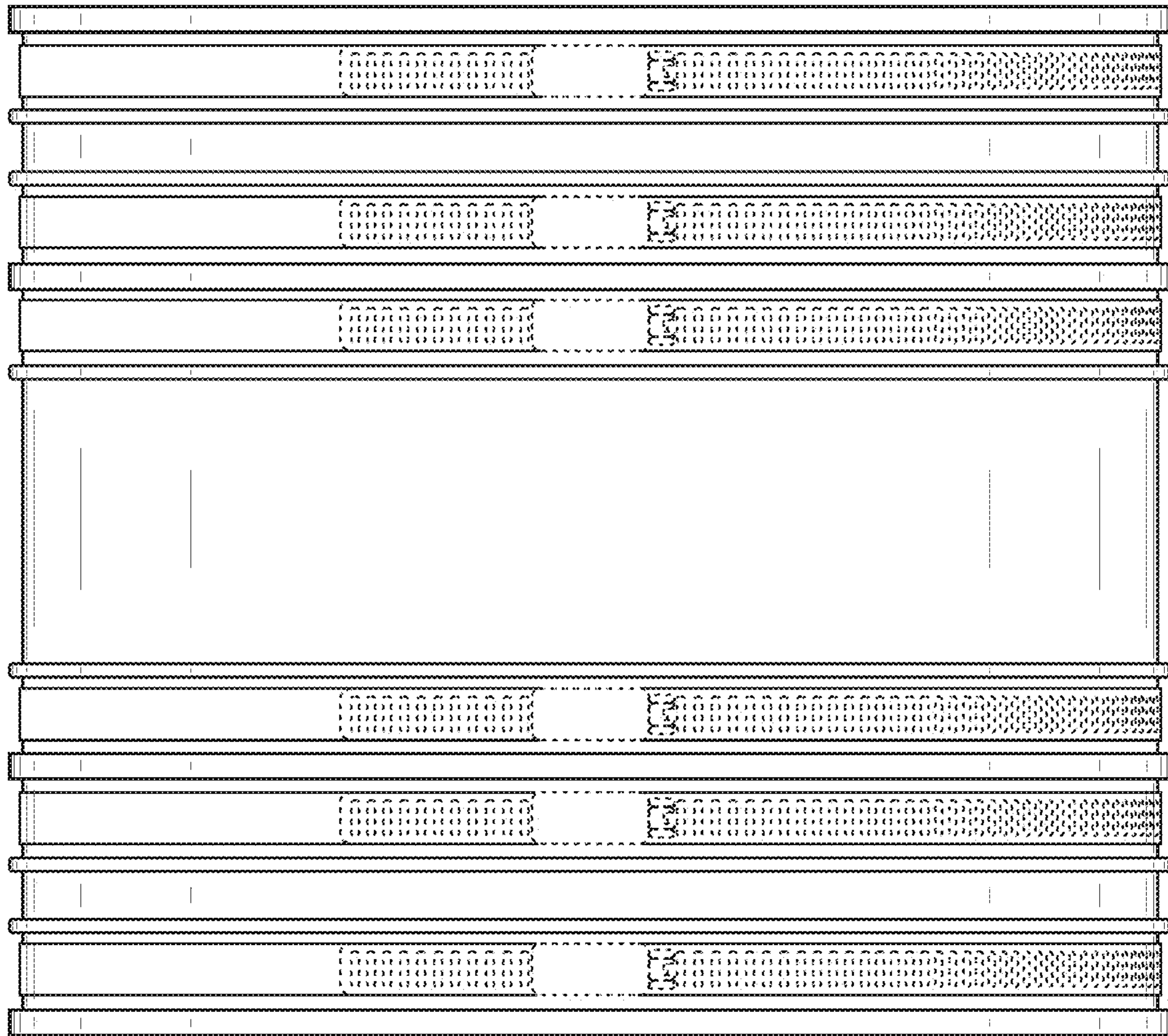
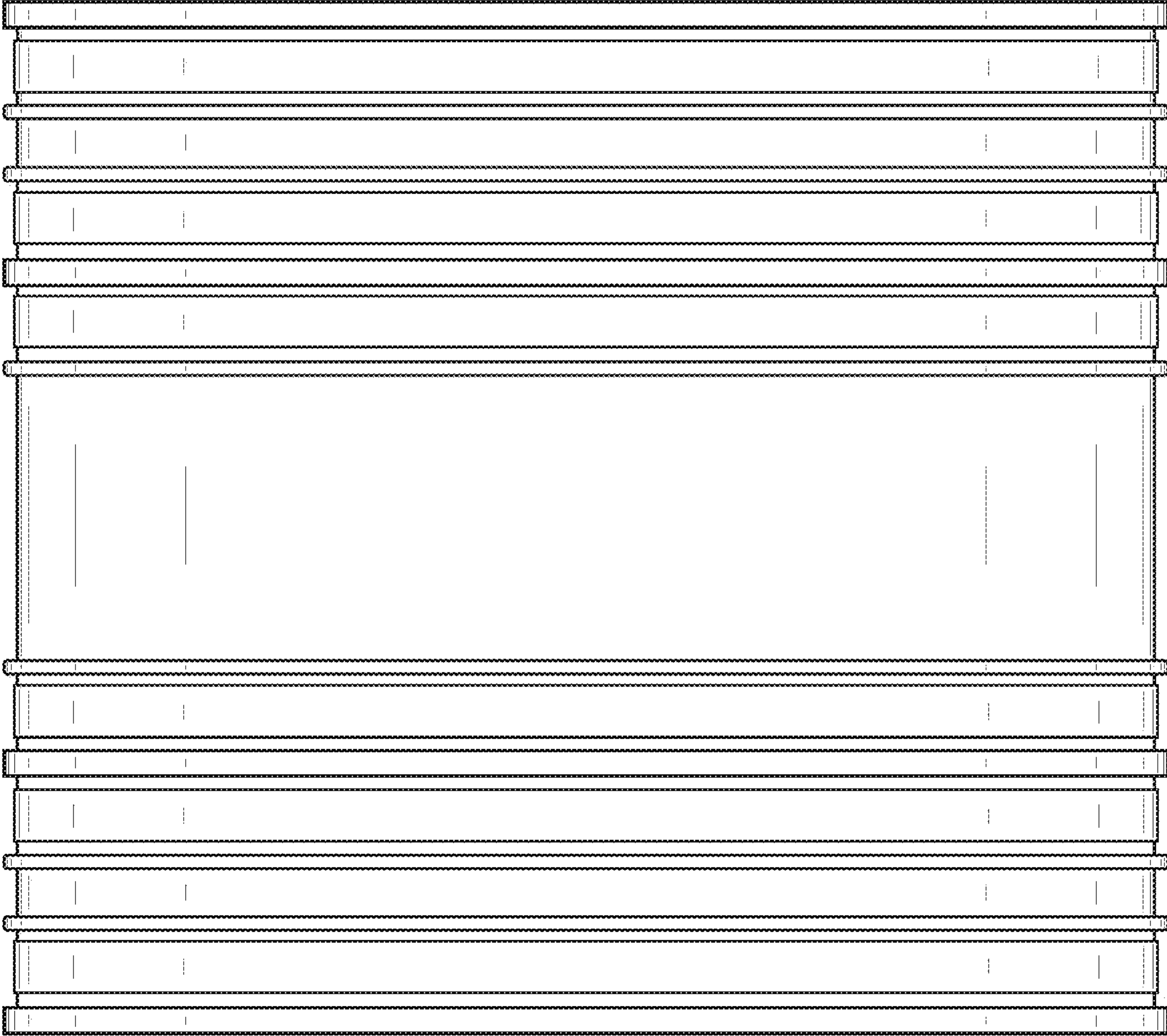
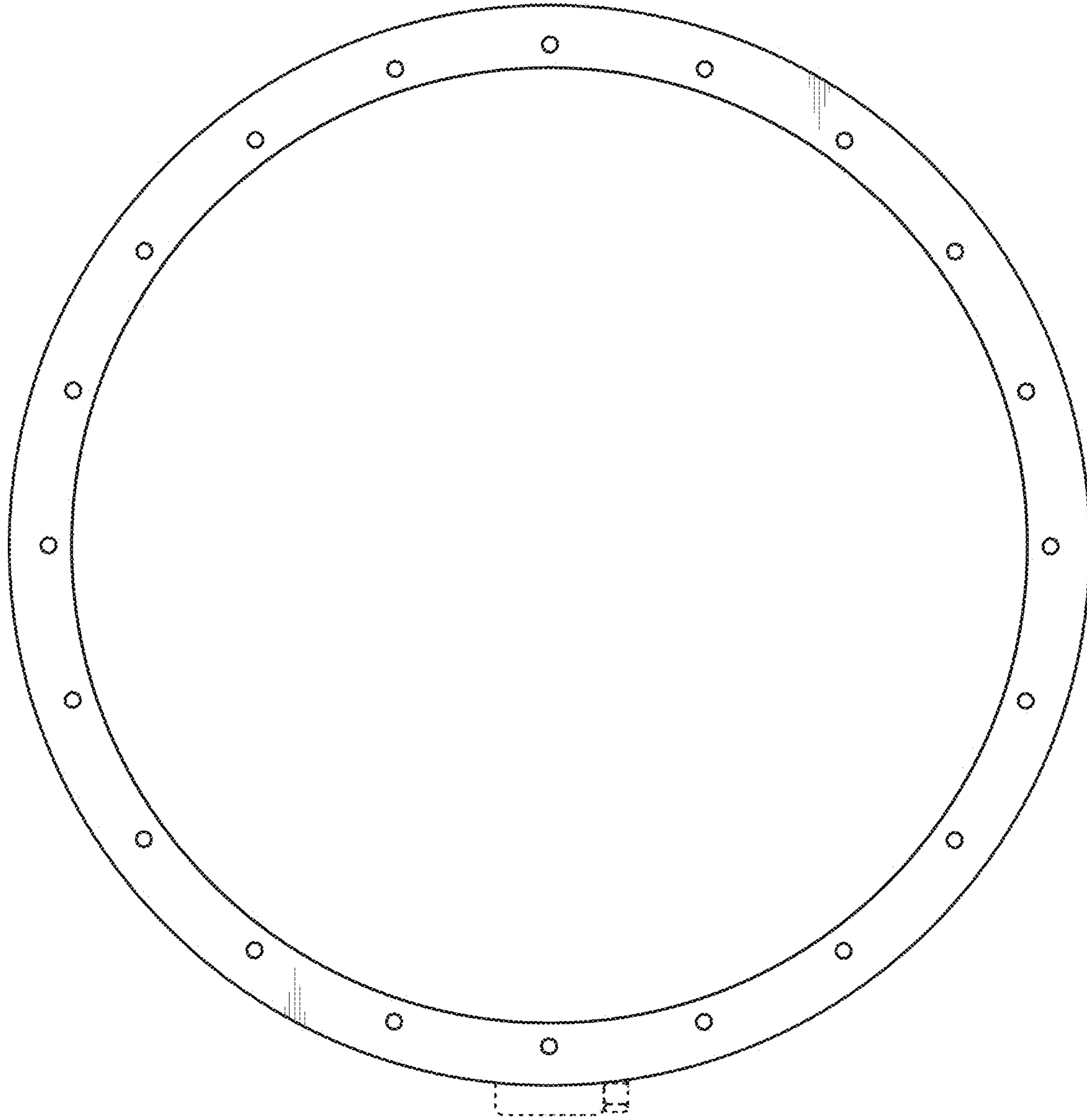

FIG. 2



**FIG. 3**



**FIG. 4**

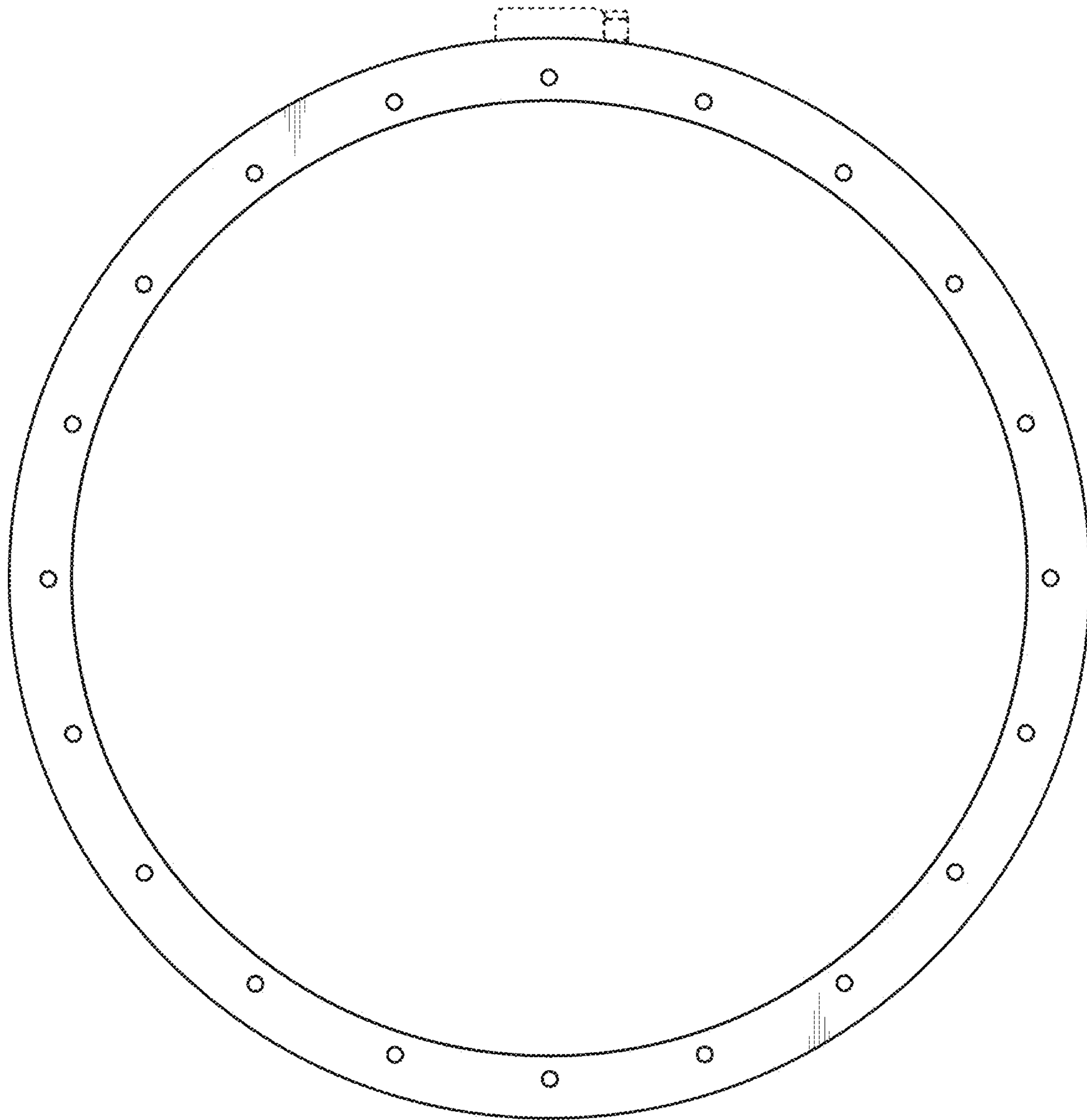

**FIG. 5**

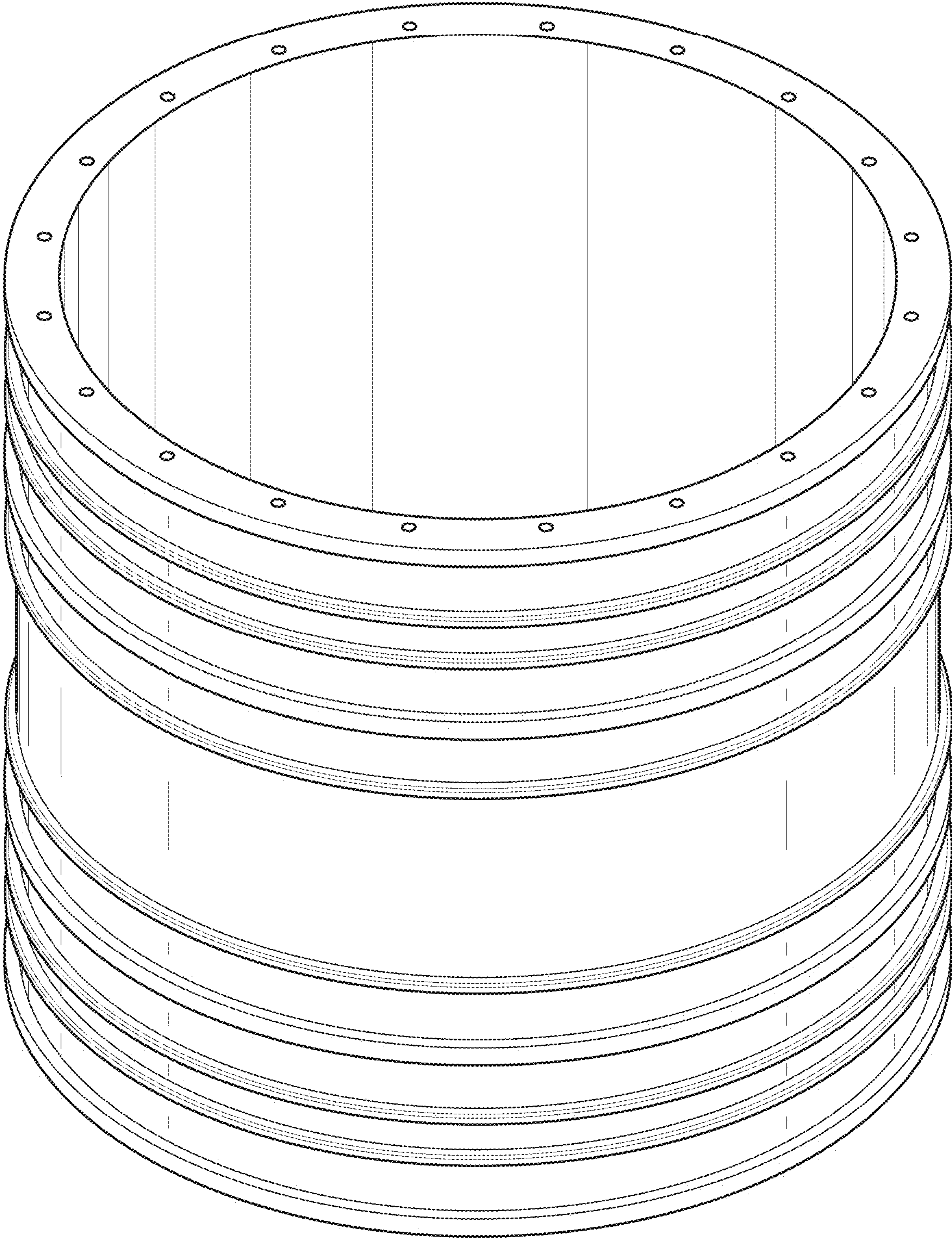

FIG. 6





**FIG. 7**



**FIG. 8**

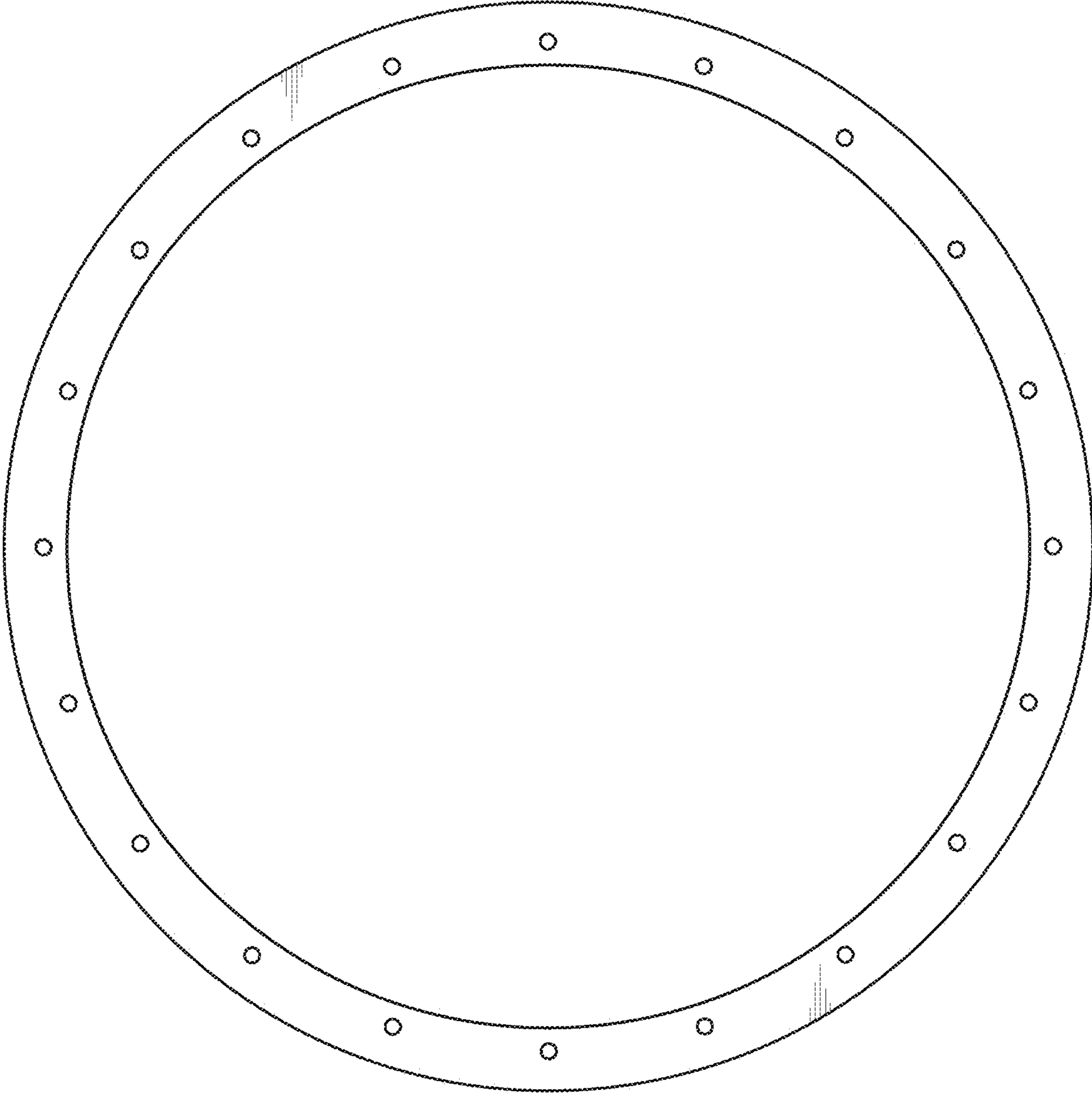
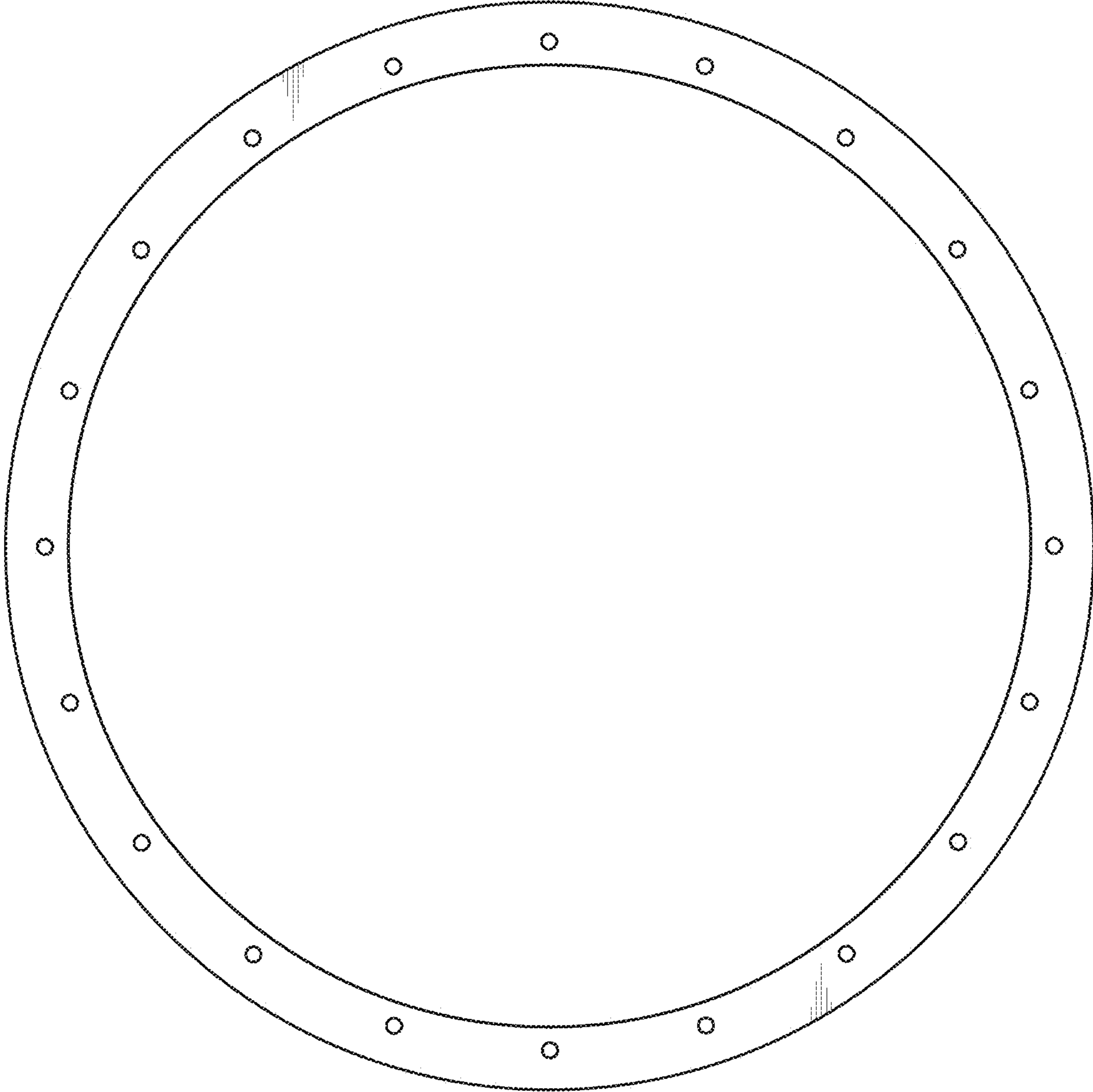

FIG. 9



**FIG. 10**

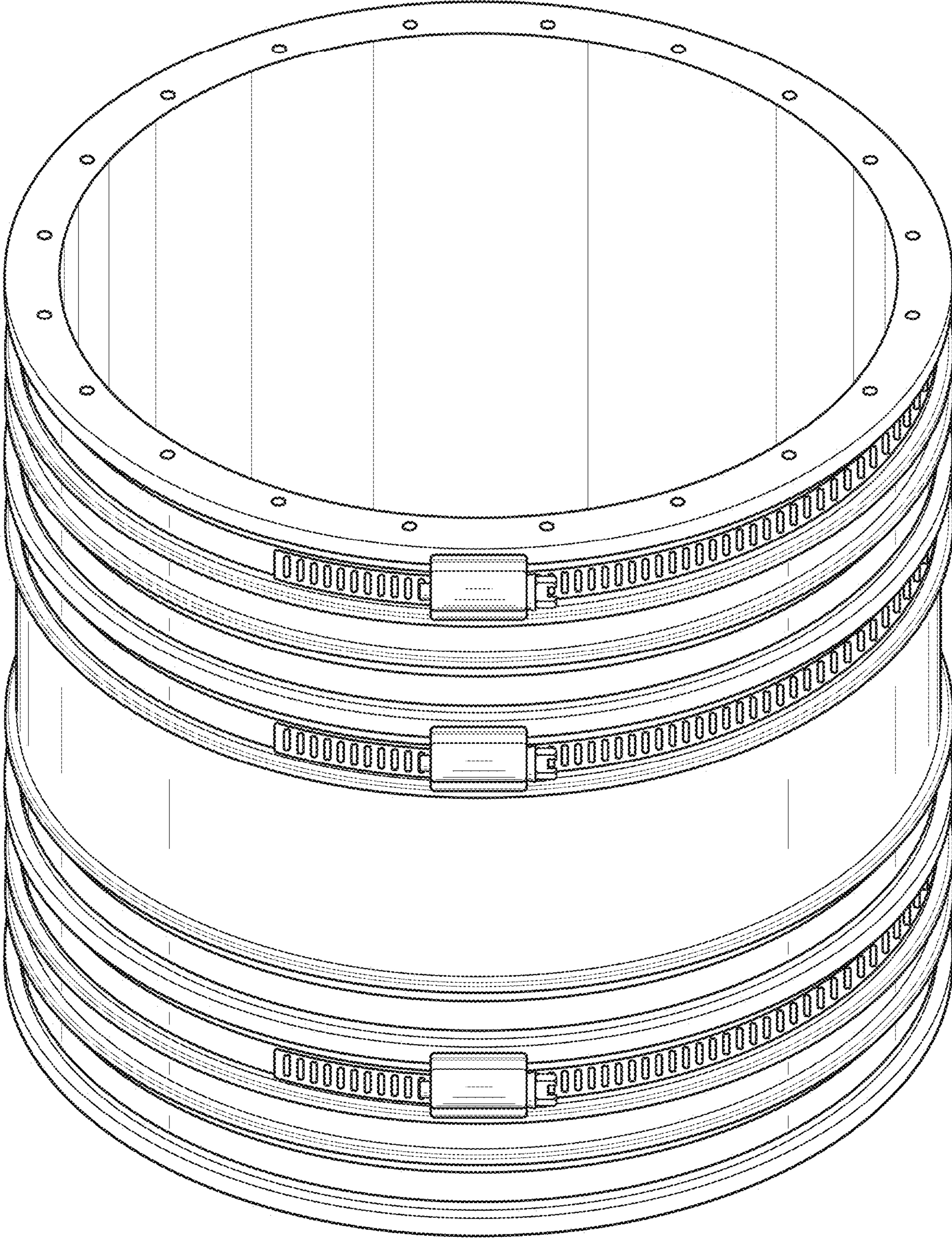

FIG. 11

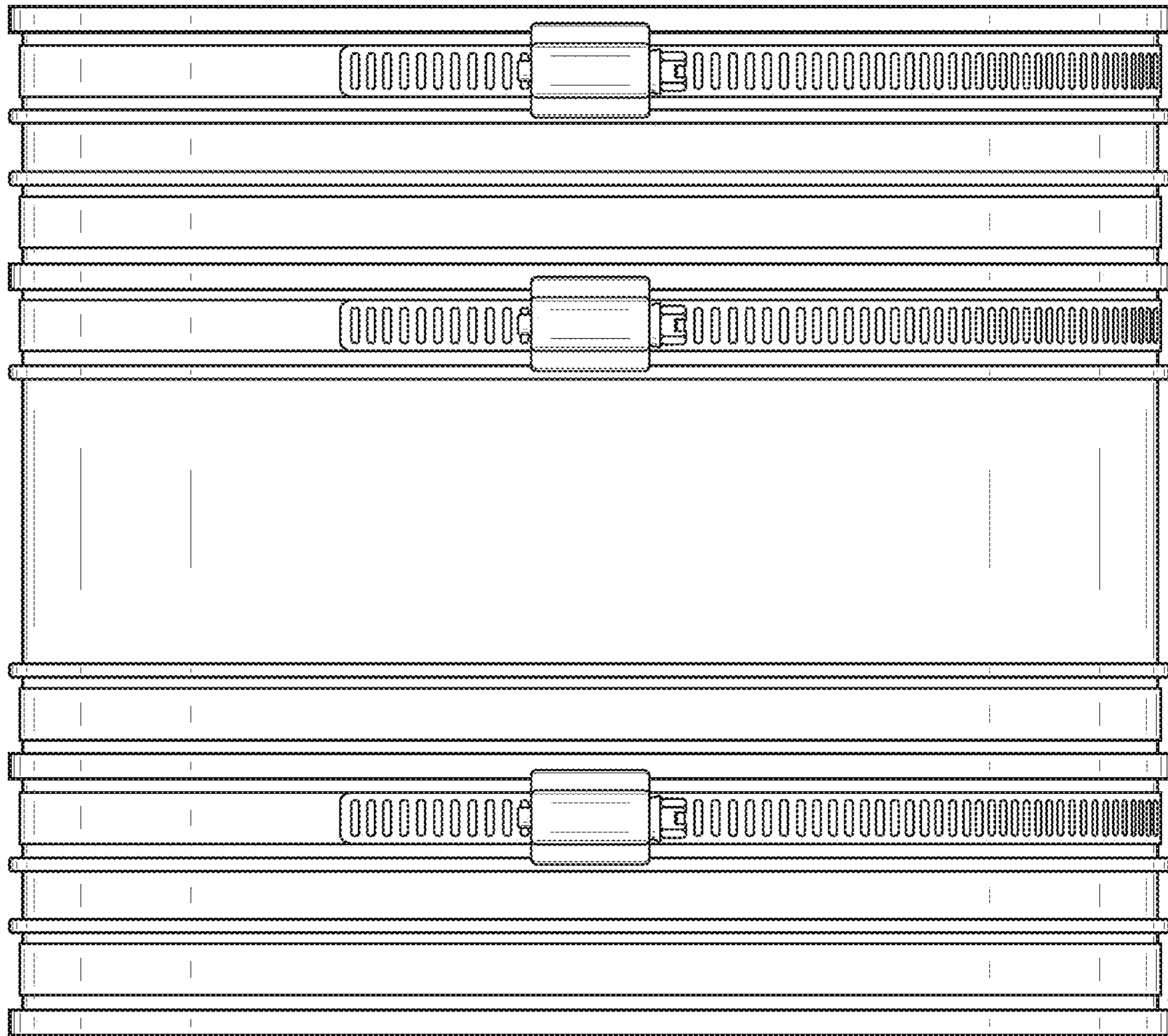

FIG. 12

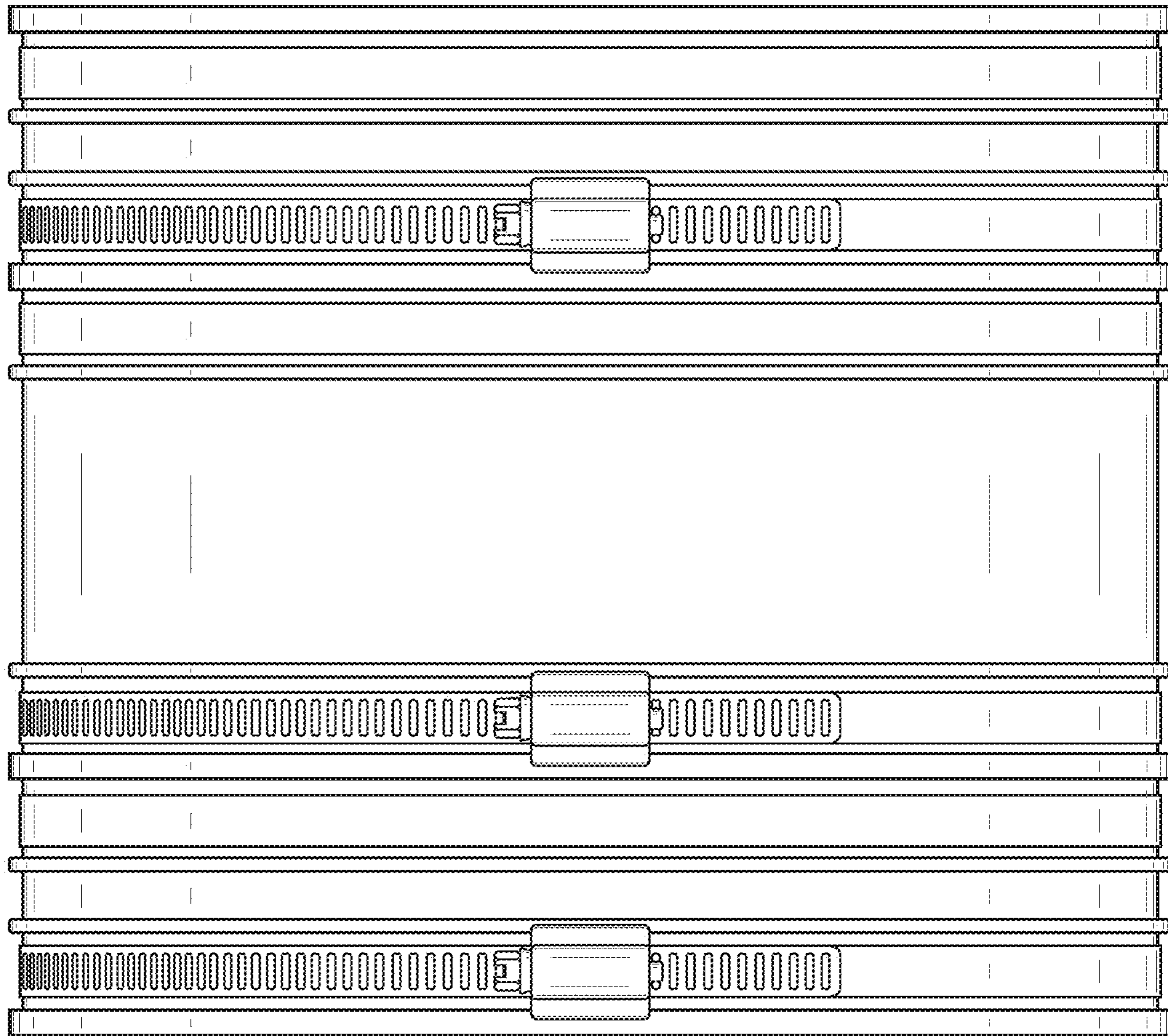

FIG. 13

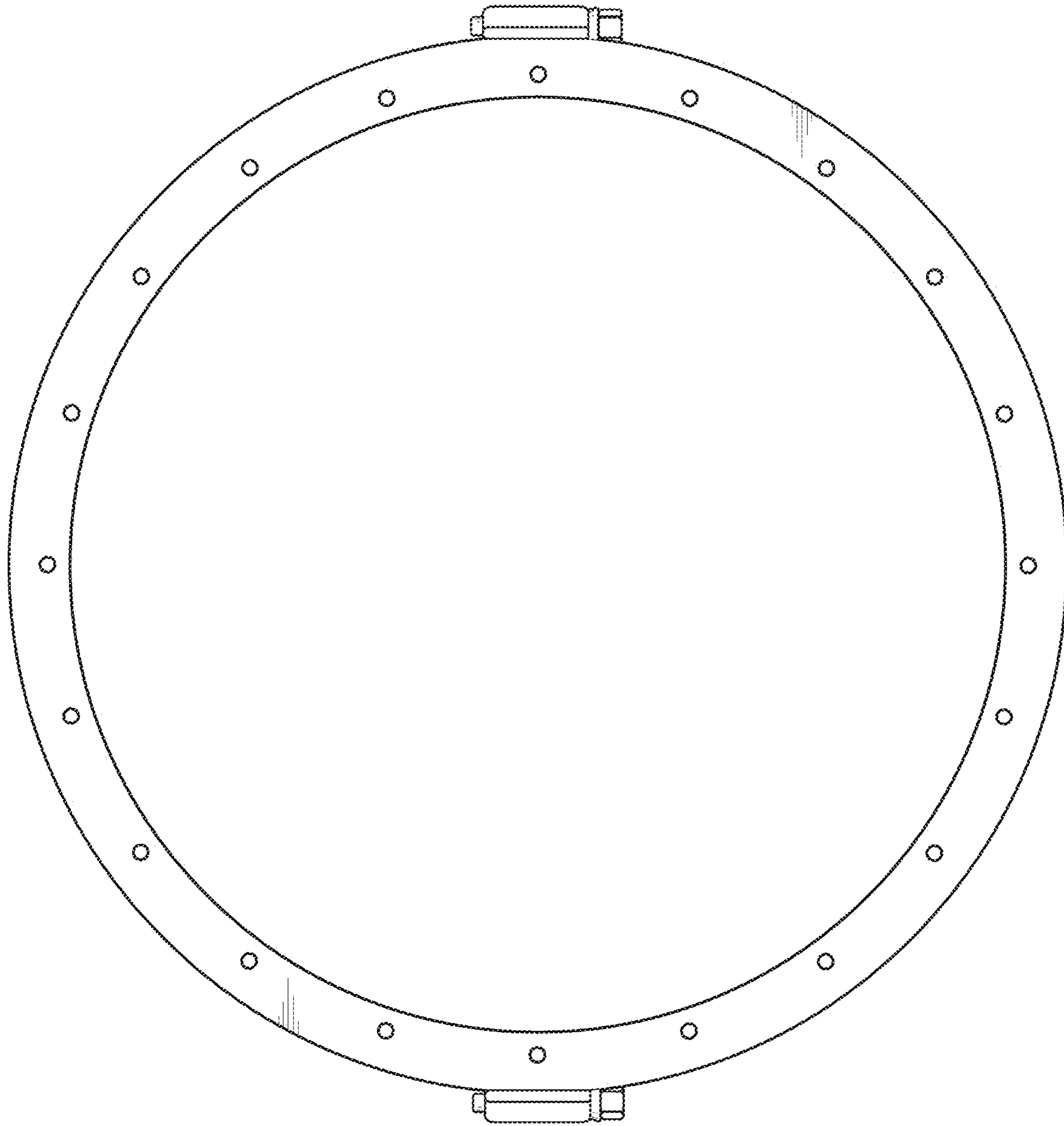

FIG. 14



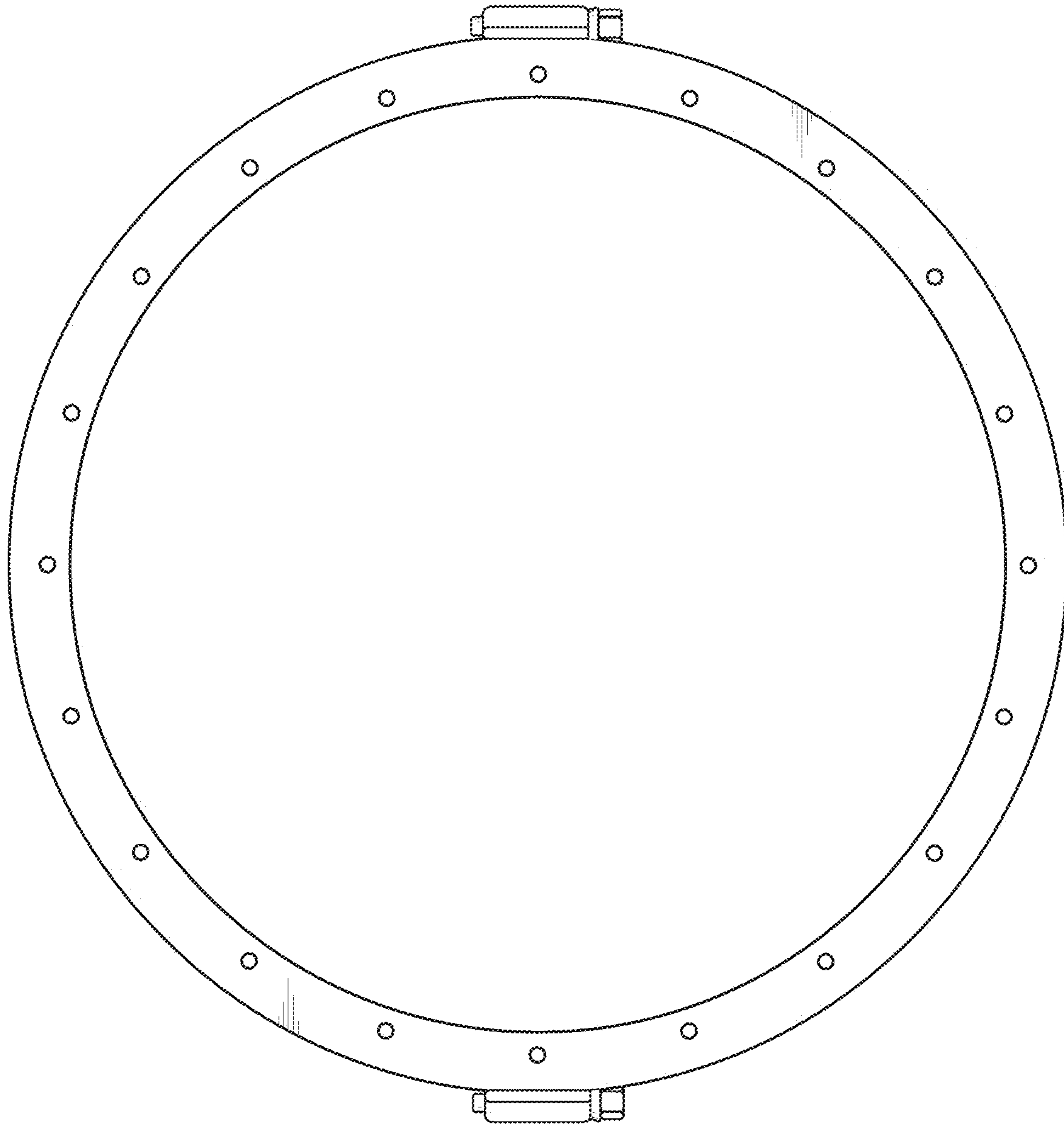

FIG. 15