

US00D956898S

(12) **United States Design Patent**  
**Kroloff**

(10) **Patent No.:** **US D956,898 S**

(45) **Date of Patent:** **\*\* Jul. 5, 2022**

(54) **GOLF CLUB HEAD**

(71) Applicant: **PARSONS XTREME GOLF, LLC**,  
Scottsdale, AZ (US)

(72) Inventor: **Caleb S. Kroloff**, Phoenix, AZ (US)

(73) Assignee: **PARSONS XTREME GOLF, LLC**,  
Scottsdale, AZ (US)

(\*\*) Term: **15 Years**

(21) Appl. No.: **29/756,879**

(22) Filed: **Oct. 30, 2020**

**Related U.S. Application Data**

(63) Continuation-in-part of application No. 29/752,556,  
filed on Sep. 28, 2020, now abandoned.

(51) **LOC (13) Cl.** ..... **21-02**

(52) **U.S. Cl.**  
USPC ..... **D21/752**

(58) **Field of Classification Search**

USPC ..... D21/733, 752, 759  
CPC ..... A63B 53/00; A63B 53/04; A63B 53/0466;  
A63B 2053/002; A63B 2053/0445; A63B  
2053/0433; A63B 2053/0491; A63B  
2053/0437; A63B 60/00; A63B 60/46  
See application file for complete search history.

(56) **References Cited**

**U.S. PATENT DOCUMENTS**

1,133,129 A	3/1915	Govan
1,269,745 A	6/1918	Robertson
1,306,029 A	6/1919	Robertson
D55,867 S	7/1920	Matters
1,509,429 A	9/1924	Hillerich
1,534,600 A	4/1925	Mattern
1,538,312 A	5/1925	Neish

(Continued)

**OTHER PUBLICATIONS**

PXG golf clubs google search; google.com; Apr. 29, 2022.\*

(Continued)

*Primary Examiner* — Mitchell I. Siegel

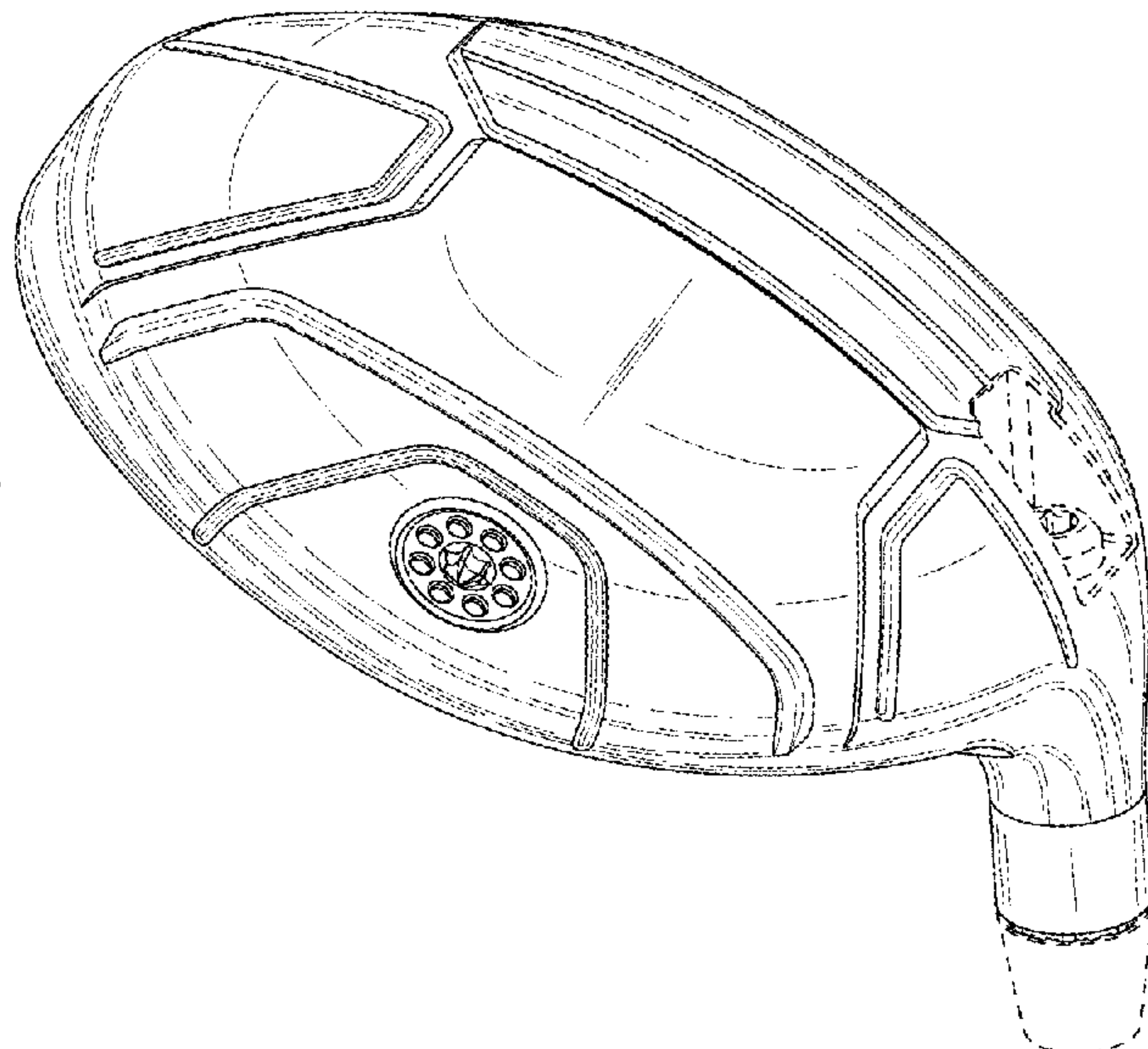
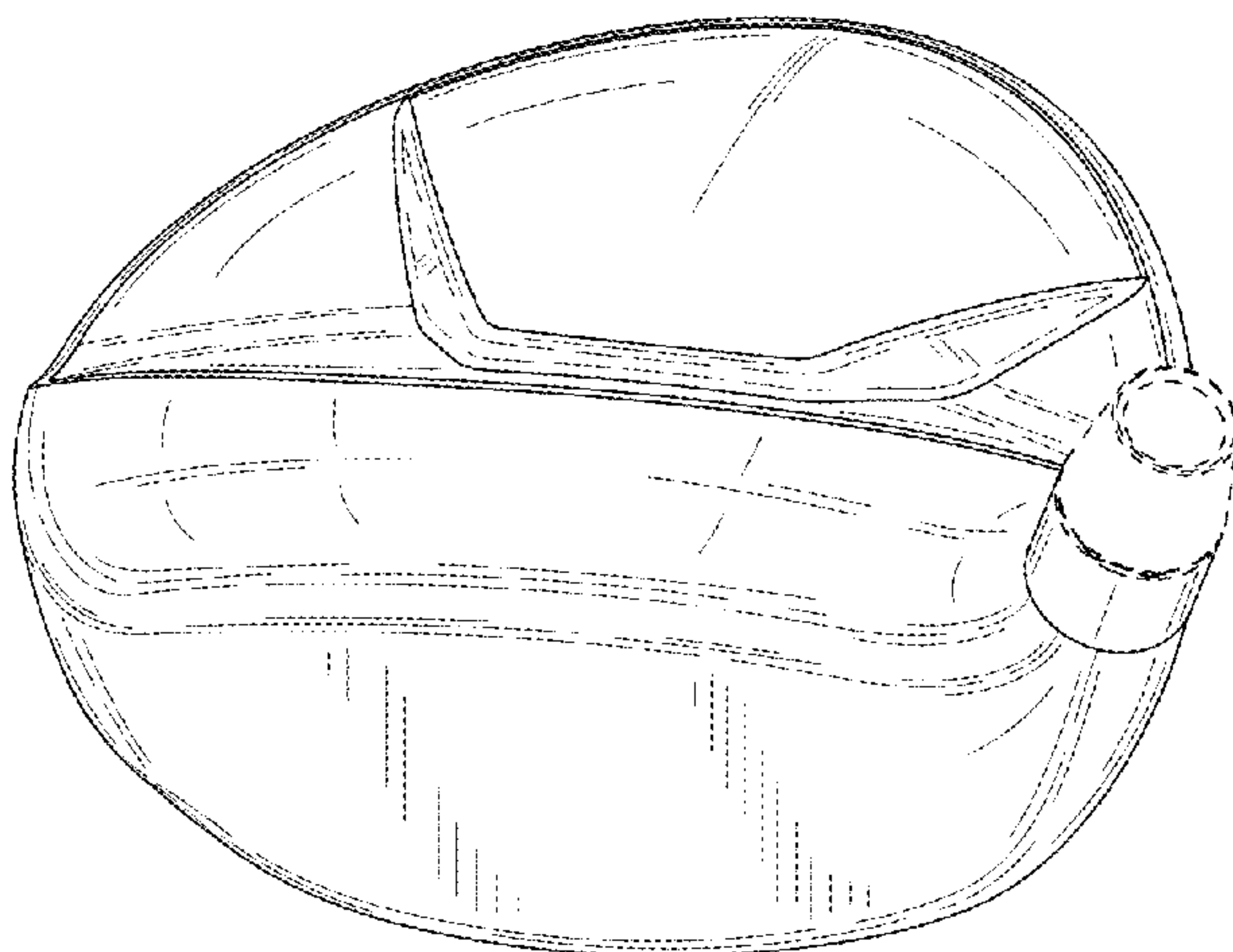
(57) **CLAIM**

The ornamental design for a golf club head, as shown and described.

**DESCRIPTION**

FIG. 1 is a top perspective view of a golf club head;  
 FIG. 2 is a bottom perspective view of the golf club head of FIG. 1;  
 FIG. 3 is a front elevational view of the golf club head of FIG. 1;  
 FIG. 4 is a rear elevational view of the golf club head of FIG. 1;  
 FIG. 5 is a top view of the golf club head of FIG. 1;  
 FIG. 6 is a bottom view of the golf club head of FIG. 1;  
 FIG. 7 is a left side view of the golf club head of FIG. 1;  
 FIG. 8 is a right side view of the golf club head of FIG. 1;  
 FIG. 9 is a top perspective view of a second embodiment of a golf club head;  
 FIG. 10 is a bottom perspective view of the golf club head of FIG. 9;  
 FIG. 11 is a front elevational view of the golf club head of FIG. 9;  
 FIG. 12 is a rear elevational view of the golf club head of FIG. 9;  
 FIG. 13 is a top view of the golf club head of FIG. 9;  
 FIG. 14 is a bottom view of the golf club head of FIG. 9;  
 FIG. 15 is a left side view of the golf club head of FIG. 9;  
 and,  
 FIG. 16 is a right side view of the golf club head of FIG. 9.  
 The broken lines shown on the drawings form no part of the claimed design.

**1 Claim, 8 Drawing Sheets**





(56)

## References Cited

## U.S. PATENT DOCUMENTS

1,543,691 A	6/1925	Beat	D414,535 S	9/1999	Mertens
1,774,590 A	9/1930	Buhrke	D421,080 S	2/2000	Chen
D94,549 S	2/1935	Jansky	D426,276 S	6/2000	Besnard et al.
D94,550 S	2/1935	Jansky	6,077,171 A	6/2000	Yoneyama
D138,437 S	8/1944	Link	D442,659 S	5/2001	Kubica et al.
D138,438 S	8/1944	Link	D443,008 S	5/2001	Kubica et al.
D138,439 S	8/1944	Link	D444,830 S	7/2001	Kubica et al.
D138,441 S	8/1944	Link	D445,862 S	7/2001	Ford
D138,442 S	8/1944	Link	6,290,609 B1	9/2001	Takeda
D164,469 S	9/1951	Behrendt	D448,824 S	10/2001	Koizumi et al.
3,020,048 A	2/1962	Carroll	D449,866 S	10/2001	Miller
D203,936 S	3/1966	Long	D457,211 S	5/2002	Bakke
D215,101 S	9/1969	Sabat	D469,833 S	2/2003	Roberts et al.
3,556,553 A	1/1971	Kolbe	D473,604 S	4/2003	Antonious
3,652,094 A	3/1972	Glover	D473,605 S	4/2003	Petersen et al.
D229,431 S	11/1973	Baker	D475,107 S	5/2003	Madore
D234,609 S	3/1975	Raymont	D476,048 S	6/2003	Cleveland et al.
D234,610 S	3/1975	Raymont	D478,140 S	8/2003	Burrows
D234,963 S	4/1975	Hirata	D478,949 S	8/2003	DeLaCruz
D239,550 S	4/1976	Timbrook	D481,087 S	10/2003	Antonious
D240,054 S	5/1976	Meissler	6,638,182 B2	10/2003	Kosmatka
D240,748 S	7/1976	Sock et al.	6,695,714 B1	2/2004	Bliss et al.
D241,956 S	10/1976	Timbrook	6,702,693 B2	3/2004	Bamber
4,085,934 A	4/1978	Churchward	6,773,360 B2	8/2004	Willett et al.
D253,778 S	12/1979	Madison	6,780,123 B2	8/2004	Hasebe
D261,167 S	10/1981	Swanson	D497,963 S	11/2004	Toulon et al.
4,332,388 A	6/1982	Crow	6,811,496 B2	11/2004	Wahl et al.
D285,954 S	9/1986	Hasegawa	D499,779 S	12/2004	Mahaffey et al.
D294,617 S	3/1988	Perkins	D502,975 S	3/2005	Schweigert et al.
4,754,977 A	7/1988	Sahm	D503,204 S	3/2005	Nicolette et al.
4,824,116 A	4/1989	Nagamoto et al.	D507,320 S	7/2005	Roberts et al.
D307,783 S	5/1990	Iinuma	D508,545 S	8/2005	Roberts et al.
4,988,104 A	1/1991	Shiotani et al.	D508,969 S	8/2005	Hasebe
D326,885 S	6/1992	Paul	6,923,733 B2	8/2005	Chen
5,158,296 A	10/1992	Lee	6,939,247 B1	9/2005	Schweigert et al.
5,176,384 A	1/1993	Sata et al.	D513,051 S	12/2005	Barez et al.
5,213,328 A	5/1993	Long et al.	D514,179 S	1/2006	Chen et al.
5,213,329 A	5/1993	Okumoto et al.	D514,183 S	1/2006	Schweigert et al.
D336,672 S	6/1993	Gorman	D514,185 S	1/2006	Barez et al.
D336,935 S	6/1993	York et al.	D515,642 S	2/2006	Antonious
D338,935 S	8/1993	Antonious	D516,650 S	3/2006	Wolfe et al.
D344,561 S	2/1994	Gorman	D518,863 S	4/2006	Motoyoshi et al.
D351,883 S	10/1994	Solheim et al.	D520,585 S	5/2006	Hasebe
D353,862 S	12/1994	Saito	D520,586 S	5/2006	Bingman
D357,520 S	4/1995	Helmstetter et al.	D522,077 S	5/2006	Schweigert et al.
5,419,560 A	5/1995	Bamber	D522,601 S	6/2006	Schweigert et al.
5,425,535 A	6/1995	Gee	D523,104 S	6/2006	Hasebe
D361,358 S	8/1995	Simmons	D523,498 S	6/2006	Chen et al.
5,447,311 A	9/1995	Viollaz et al.	D523,501 S	6/2006	Nicolette et al.
5,451,056 A	9/1995	Manning	D523,917 S	6/2006	Wolfe et al.
D362,884 S	10/1995	Blough et al.	D524,889 S	7/2006	Yu et al.
D362,885 S	10/1995	Blough et al.	D526,372 S	8/2006	Kohno
D362,887 S	10/1995	Blough et al.	D526,694 S	8/2006	Schweigert et al.
5,518,243 A	5/1996	Redman	7,121,956 B2	10/2006	Lo
D370,514 S	6/1996	Blough et al.	7,128,663 B2	10/2006	Bamber
D371,816 S	7/1996	Yoshioka	D534,595 S	1/2007	Hasebe
5,540,437 A	7/1996	Bamber	D534,599 S	1/2007	Barez et al.
D378,111 S	2/1997	Parente et al.	7,156,751 B2	1/2007	Wahl et al.
5,637,045 A	6/1997	Igarashi	7,166,040 B2	1/2007	Hoffman et al.
D384,120 S	9/1997	Cruz et al.	D536,401 S	2/2007	Kawami
5,669,830 A	9/1997	Bamber	D536,402 S	2/2007	Kawami
D389,541 S	1/1998	Huan-Chiang	D536,403 S	2/2007	Kawami
D395,476 S	6/1998	Pond et al.	D537,495 S	2/2007	Schweigert et al.
5,766,091 A	6/1998	Humphrey et al.	7,182,698 B2	2/2007	Tseng
5,766,092 A	6/1998	Mimeur et al.	D538,363 S	3/2007	Schweigert et al.
5,788,584 A	8/1998	Parente et al.	D538,371 S	3/2007	Kawami
D399,277 S	10/1998	Ezaki	7,186,190 B1	3/2007	Beach et al.
5,827,132 A	10/1998	Bamber	7,207,900 B2	4/2007	Nicolette et al.
D400,625 S	11/1998	Kubica et al.	D543,601 S	5/2007	Kawami
D400,627 S	11/1998	Kubica et al.	7,223,180 B2	5/2007	Willett et al.
D405,489 S	2/1999	Kubica et al.	D552,198 S	10/2007	Schweigert et al.
D405,492 S	2/1999	Kubica et al.	D555,219 S	11/2007	Lin
D408,485 S	4/1999	Takahashi et al.	D556,288 S	11/2007	Robinson et al.
5,899,821 A	5/1999	Hsu et al.	D557,363 S	12/2007	Jertson et al.
5,935,016 A	8/1999	Antonious	D558,287 S	12/2007	Jertson et al.
			7,303,486 B2	12/2007	Imamoto
			D559,932 S	1/2008	Belmont
			D561,284 S	2/2008	Nagai et al.
			D562,421 S	2/2008	Jertson et al.



(56)

References Cited

U.S. PATENT DOCUMENTS

D563,498 S	3/2008	Jertson et al.	8,088,025 B2	1/2012	Wahl et al.
D564,054 S	3/2008	Jertson et al.	8,092,319 B1	1/2012	Cackett et al.
D564,055 S	3/2008	Jertson et al.	8,105,180 B1	1/2012	Cackett et al.
7,338,388 B2	3/2008	Schweigert et al.	D658,248 S	4/2012	Nunez et al.
7,347,794 B2	3/2008	Schweigert	D661,751 S *	6/2012	Nicolette ..... D21/752
D567,317 S	4/2008	Jertson et al.	D661,756 S	6/2012	Nicolette et al.
7,351,164 B2	4/2008	Schweigert et al.	8,221,262 B1	7/2012	Cackett et al.
D569,933 S	5/2008	Jertson et al.	8,246,467 B2	8/2012	Huang et al.
D569,934 S	5/2008	Jertson et al.	8,257,196 B1	9/2012	Abbott et al.
D569,935 S	5/2008	Schweigert et al.	8,257,197 B2	9/2012	Schweigert
D569,936 S	5/2008	Schweigert et al.	8,262,506 B2	9/2012	Watson et al.
D569,942 S	5/2008	Jertson et al.	8,328,662 B2	12/2012	Nakamura et al.
D570,937 S	6/2008	Schweigert et al.	D673,630 S	1/2013	Schweigert
D570,938 S	6/2008	Jertson et al.	D673,632 S	1/2013	Schweigert et al.
7,396,299 B2	7/2008	Nicolette et al.	8,371,957 B2	2/2013	Schweigert et al.
7,407,447 B2	8/2008	Beach et al.	8,376,878 B2	2/2013	Bennett et al.
7,410,425 B2	8/2008	Willett et al.	D680,179 S	4/2013	Solheim et al.
7,410,426 B2	8/2008	Willett et al.	D681,142 S	4/2013	Fossum et al.
7,419,441 B2	9/2008	Hoffman et al.	8,414,422 B2	4/2013	Peralta et al.
D579,507 S	10/2008	Llewellyn et al.	D684,230 S *	6/2013	Roberts ..... D21/752
7,448,963 B2	11/2008	Beach et al.	8,485,919 B2	7/2013	Rice et al.
7,448,964 B2	11/2008	Schweigert et al.	8,506,420 B2	8/2013	Hocknell et al.
D584,370 S	1/2009	Cleveland et al.	D689,156 S	9/2013	Stokke et al.
7,530,904 B2	5/2009	Beach et al.	D691,230 S	10/2013	Chen et al.
D594,518 S	6/2009	Schweigert	8,545,343 B2	10/2013	Boyd et al.
D594,520 S	6/2009	Schweigert et al.	8,562,457 B2	10/2013	Beach et al.
D594,521 S	6/2009	Jertson et al.	8,574,094 B2	11/2013	Nicolette et al.
D594,919 S	6/2009	Schweigert et al.	8,608,587 B2	12/2013	Henrikson et al.
7,540,811 B2	6/2009	Beach et al.	8,628,431 B2	1/2014	Schweigert et al.
D597,620 S	8/2009	Taylor et al.	8,657,700 B2	2/2014	Nicolette et al.
7,568,985 B2	8/2009	Beach et al.	8,663,026 B2	3/2014	Blowers et al.
7,578,753 B2	8/2009	Beach et al.	8,690,710 B2	4/2014	Nicolette et al.
D600,297 S	9/2009	Jertson et al.	D707,316 S	6/2014	Aguayo et al.
7,584,531 B2	9/2009	Schweigert et al.	D707,317 S	6/2014	Aguayo et al.
7,588,502 B2	9/2009	Nishino	8,753,230 B2	6/2014	Stokke et al.
7,591,738 B2	9/2009	Beach et al.	8,777,778 B2	7/2014	Solheim et al.
D603,472 S	11/2009	Schweigert et al.	8,784,232 B2	7/2014	Jertson et al.
D604,783 S	11/2009	Nicolette et al.	8,790,196 B2	7/2014	Solheim et al.
7,611,424 B2	11/2009	Nagai et al.	8,808,108 B2	8/2014	Schweigert
7,621,823 B2	11/2009	Beach et al.	D712,989 S	9/2014	Gillig
D605,715 S	12/2009	Barez et al.	8,826,512 B2	9/2014	Schweigert
D606,605 S	12/2009	Wada et al.	8,827,832 B2	9/2014	Breier et al.
D607,070 S	12/2009	Wada et al.	8,827,833 B2	9/2014	Amano et al.
D607,071 S	12/2009	Wada et al.	8,845,455 B2	9/2014	Ban et al.
7,632,194 B2	12/2009	Beach et al.	D714,894 S	10/2014	Tang et al.
7,658,686 B2	2/2010	Soracco	D716,387 S	10/2014	Aguayo et al.
D612,438 S	3/2010	Carlyle et al.	D716,388 S	10/2014	Aguayo et al.
D612,439 S	3/2010	Carlyle et al.	8,858,362 B1	10/2014	Leposky et al.
7,713,142 B2	5/2010	Hoffman et al.	D721,544 S	1/2015	Hollander
7,717,804 B2	5/2010	Beach et al.	D722,352 S	2/2015	Nicolette et al.
7,717,805 B2	5/2010	Beach et al.	D723,120 S	2/2015	Nicolette
D617,406 S	6/2010	Carlyle et al.	8,961,336 B1	2/2015	Parsons et al.
D618,293 S	6/2010	Foster et al.	D724,164 S	3/2015	Schweigert et al.
D618,746 S	6/2010	Jertson et al.	8,979,671 B1	3/2015	Demille et al.
D618,747 S	6/2010	Schweigert et al.	D726,265 S	4/2015	Nicolette
D618,753 S	6/2010	Jertson et al.	D729,892 S	5/2015	Nicolette et al.
D618,754 S	6/2010	Schweigert et al.	D733,234 S	6/2015	Nicolette
7,744,484 B1	6/2010	Chao	9,199,140 B1	12/2015	Schweigert et al.
D621,893 S	8/2010	Nicolette et al.	9,199,143 B1	12/2015	Parsons et al.
7,798,203 B2	9/2010	Schweigert et al.	D746,927 S	1/2016	Parsons et al.
7,798,917 B2	9/2010	Nguyen et al.	D748,214 S	1/2016	Nicolette et al.
7,815,521 B2	10/2010	Ban et al.	D748,749 S	2/2016	Nicolette et al.
7,846,040 B2	12/2010	Ban	D753,251 S	4/2016	Schweigert et al.
7,846,041 B2	12/2010	Beach et al.	D755,319 S	5/2016	Nicolette et al.
D633,967 S	3/2011	Carlyle et al.	D756,471 S	5/2016	Nicolette et al.
D635,626 S	4/2011	Nicolette et al.	9,352,197 B2	5/2016	Parsons et al.
7,927,229 B2	4/2011	Jertson et al.	D759,178 S	6/2016	Nicolette
D638,893 S	5/2011	Schweigert et al.	D760,334 S	6/2016	Schweigert et al.
D638,896 S	5/2011	Schweigert et al.	9,399,158 B2	7/2016	Parsons et al.
7,938,738 B2	5/2011	Roach	D763,997 S *	8/2016	Tang ..... D21/759
7,963,861 B2	6/2011	Beach et al.	9,421,437 B2	8/2016	Parsons et al.
D643,490 S	8/2011	Wada et al.	9,427,634 B2	8/2016	Parsons et al.
8,012,038 B1	9/2011	Beach et al.	D767,696 S	9/2016	Parsons et al.
D647,585 S	10/2011	Jertson et al.	D776,216 S	1/2017	Schweigert et al.
8,062,150 B2	11/2011	Gilbert et al.	D777,858 S	1/2017	Schweigert et al.
			9,555,295 B2	1/2017	Schweigert et al.
			9,630,070 B2	4/2017	Parsons et al.
			D802,069 S	11/2017	Parsons et al.
			D802,070 S	11/2017	Parsons et al.

(56)

References Cited

U.S. PATENT DOCUMENTS

D807,976 S 1/2018 Parsons et al.  
 D827,067 S 8/2018 Becktor et al.  
 D827,745 S 9/2018 Schweigert et al.  
 D839,372 S 1/2019 Schweigert et al.  
 D850,551 S \* 6/2019 Parsons ..... D21/759  
 D852,304 S \* 6/2019 Parsons ..... D21/752  
 D897,462 S \* 9/2020 Parsons ..... D21/752  
 D914,820 S \* 3/2021 Parsons ..... D21/759  
 D930,100 S \* 9/2021 Parsons ..... D21/759  
 D933,148 S \* 10/2021 Nicolette ..... D21/752  
 D933,149 S \* 10/2021 Kroloff ..... D21/752  
 D933,151 S \* 10/2021 Kroloff ..... D21/752  
 D940,801 S \* 1/2022 Parsons ..... D21/752  
 D940,802 S \* 1/2022 Parsons ..... D21/752  
 2002/0107087 A1 8/2002 Fagot  
 2003/0139226 A1 7/2003 Cheng et al.  
 2003/0176231 A1 9/2003 Hasebe  
 2004/0204263 A1 10/2004 Fagot et al.  
 2005/0009632 A1 1/2005 Schweigert et al.  
 2005/0014573 A1 1/2005 Lee  
 2005/0119066 A1 6/2005 Stites et al.  
 2005/0239569 A1 10/2005 Best et al.  
 2005/0277485 A1 12/2005 Hou et al.  
 2006/0105856 A1 5/2006 Lo  
 2006/0111200 A1 5/2006 Poynor  
 2007/0032308 A1 2/2007 Fagot et al.  
 2007/0225084 A1 9/2007 Schweigert et al.  
 2007/0293344 A1 12/2007 Davis  
 2008/0004133 A1 1/2008 Schweigert  
 2008/0058113 A1 3/2008 Nicolette et al.  
 2008/0188322 A1 8/2008 Anderson et al.  
 2008/0300065 A1 12/2008 Schweigert  
 2009/0029790 A1 1/2009 Nicolette et al.  
 2009/0029795 A1 1/2009 Schweigert et al.  
 2010/0130306 A1 5/2010 Schweigert  
 2010/0144461 A1 6/2010 Ban  
 2010/0178999 A1 7/2010 Nicolette et al.  
 2011/0111883 A1 5/2011 Cackett  
 2011/0143858 A1 6/2011 Peralta et al.  
 2011/0165963 A1 7/2011 Cackett et al.

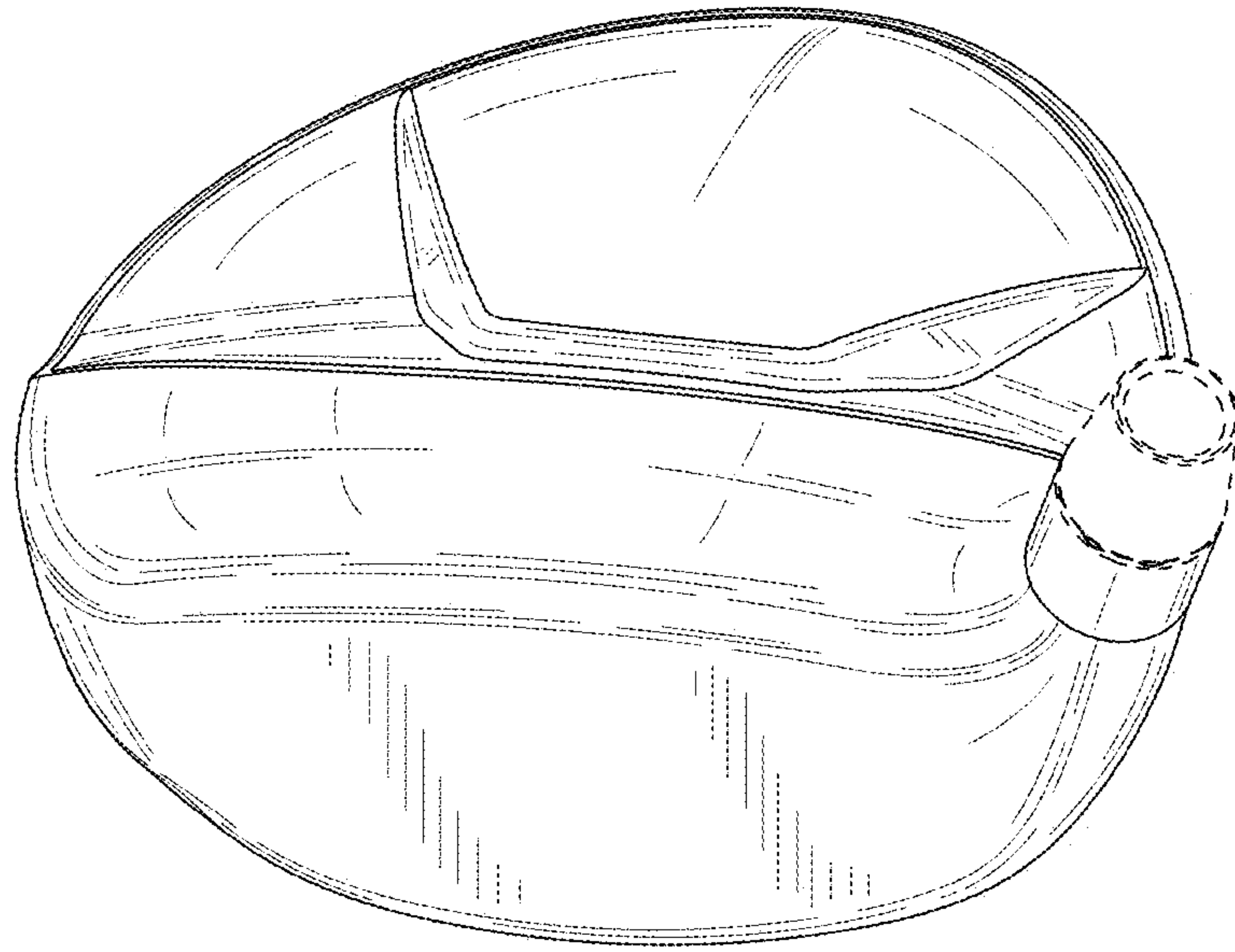
2011/0269567 A1 11/2011 Ban et al.  
 2011/0294596 A1 12/2011 Ban  
 2012/0202615 A1 8/2012 Beach et al.  
 2013/0137532 A1 5/2013 Deshmukh et al.  
 2013/0225319 A1 8/2013 Kato  
 2013/0281226 A1 10/2013 Ban  
 2013/0288823 A1 10/2013 Hebreo  
 2013/0303303 A1 11/2013 Ban  
 2013/0303304 A1 11/2013 Sato  
 2013/0310192 A1 11/2013 Wahl et al.  
 2014/0080621 A1 3/2014 Nicolette et al.  
 2014/0128175 A1 5/2014 Jertson et al.  
 2014/0274441 A1 9/2014 Greer  
 2014/0274451 A1 9/2014 Knight et al.  
 2015/0231454 A1 8/2015 Parsons et al.  
 2015/0231806 A1 8/2015 Parsons et al.

OTHER PUBLICATIONS

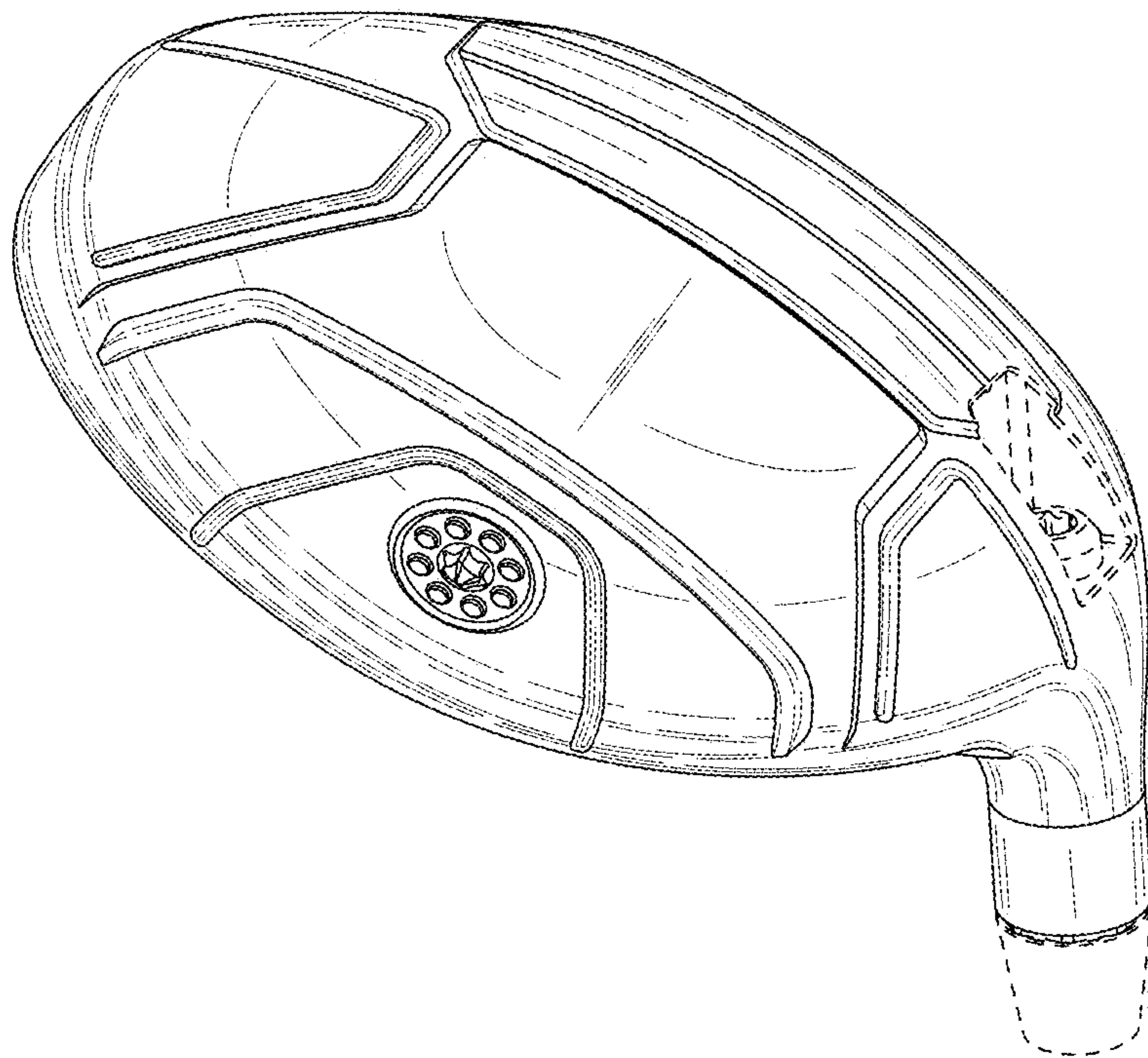
PXG.com; Apr. 29, 2022.\*  
 International Search Report and Written Opinion Received in Connection With the Corresponding Application No. PCT/US15/42484, dated Oct. 19, 2015 (12 Pages).  
 International Search Report and Written Opinion Received in Connection With the Corresponding Application No. PCT/US2015/016666, dated May 14, 2015 (8 Pages).  
 International Search Report and Written Opinion Received in Connection With the Corresponding Application No. PCT/US2015/042282, dated Oct. 13, 2015 (12 Pages).  
 Kozuckowski, Zak, "Callaway Mack Daddy 2 PM Grind Wedges" (<http://golfwrz.com/276203/callaway-mack-daddy-2-pm-grind-wedges/>), www.golfwrz.com, Golfwrz Holdings, LLC, Published Jan. 21, 2015.  
 U.S. Appl. No. 29/512,313, Nicolette, "Golf Club Head," filed Dec. 18, 2018.  
 Wall, Jonathan, "Details: Phil's Prototype Mack Daddy PM—Grind Wedge," (<http://www.pgatour.com/equipmentreport/2015/01/21/callaway-wedge.html>), www.pgatour.com, PGA Tour, Inc., Published Jan. 21, 2015.

\* cited by examiner

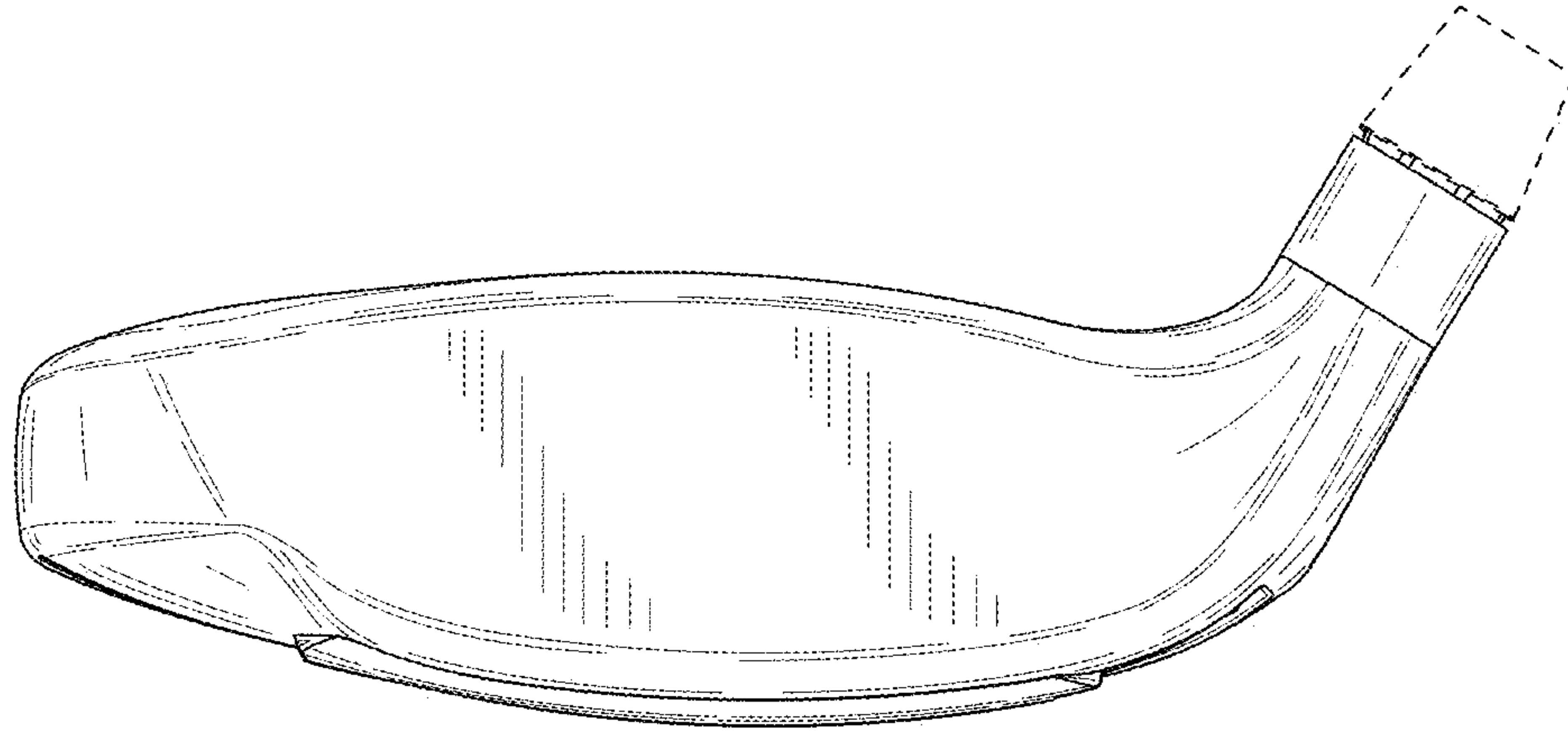




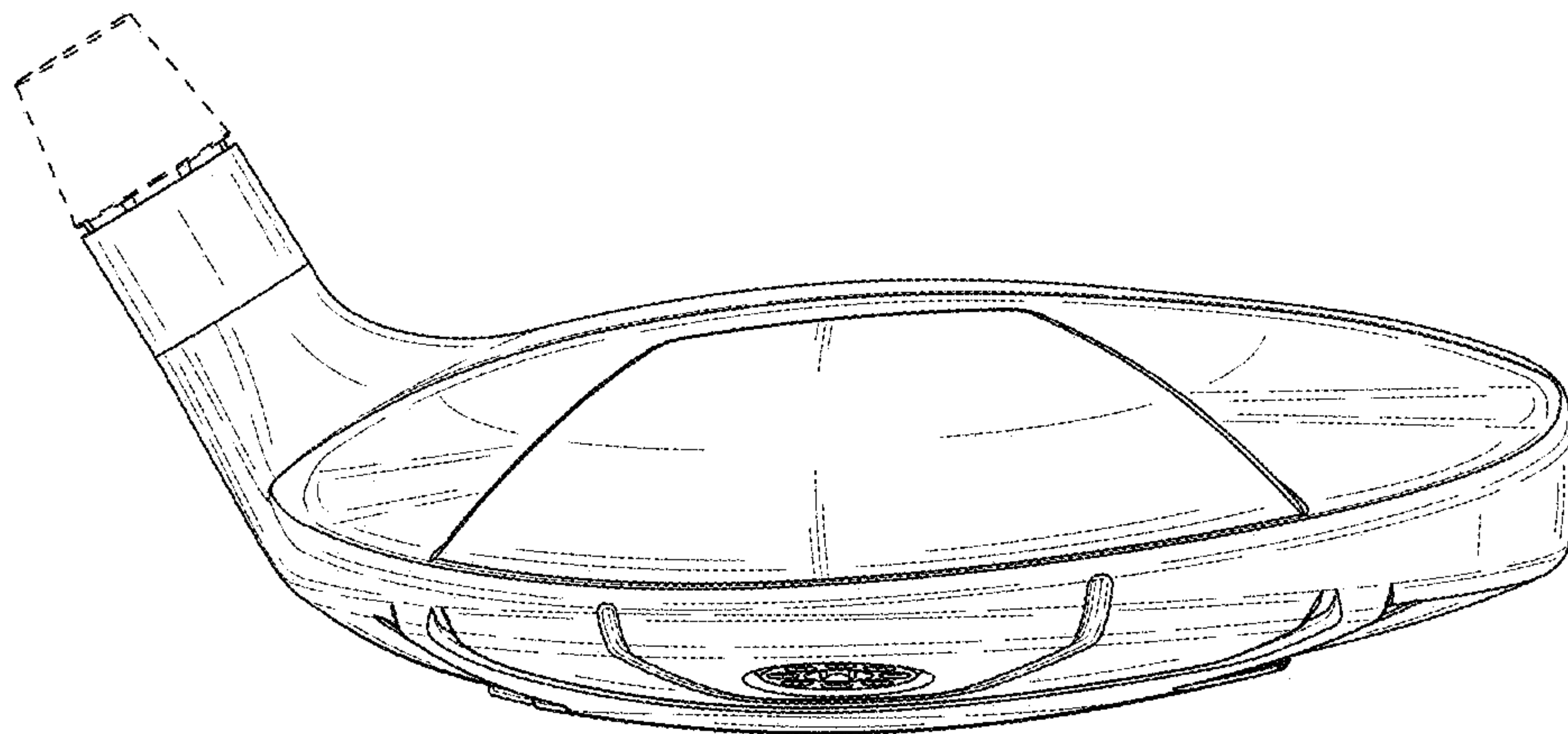
**FIG. 1**



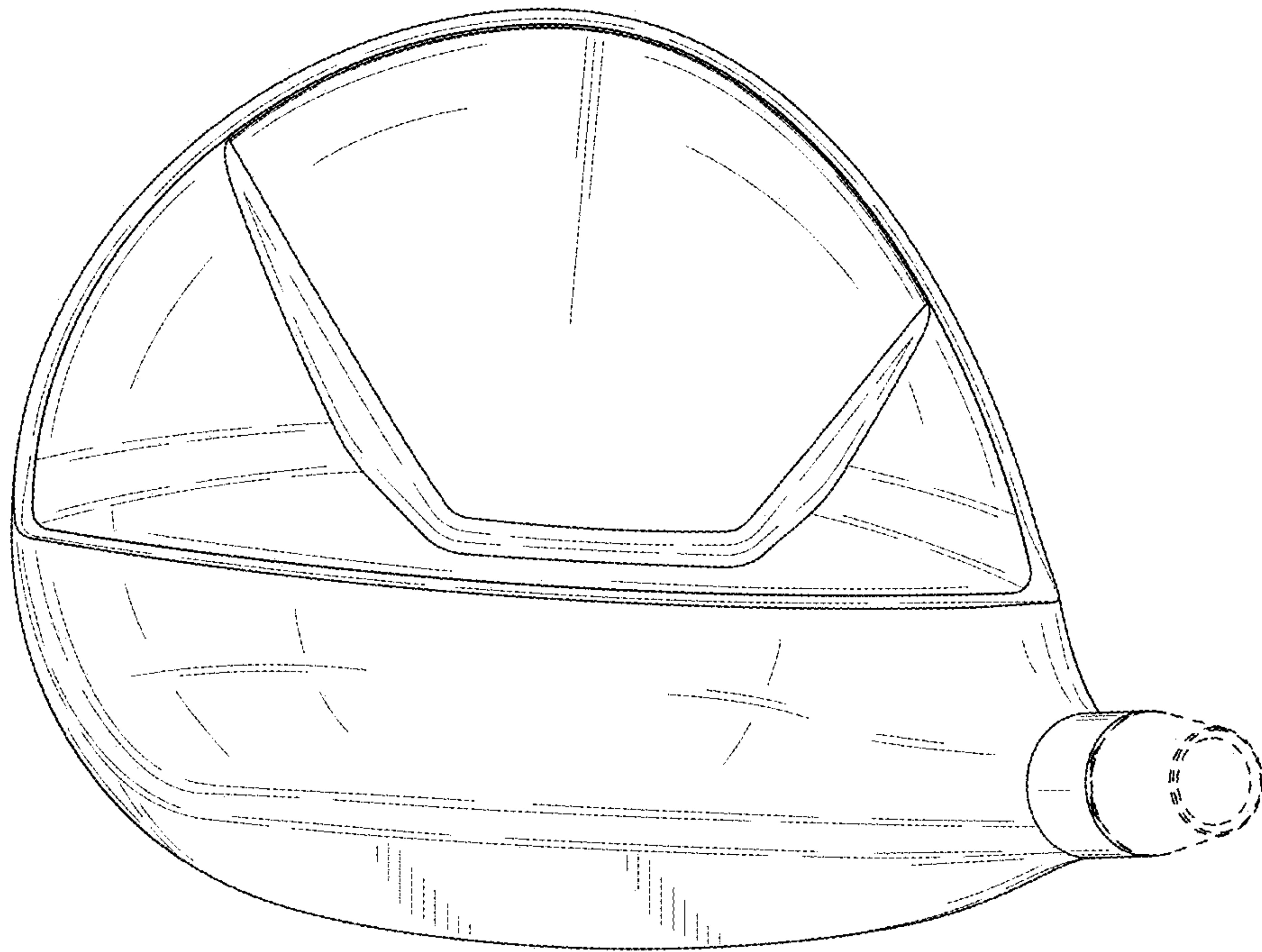
**FIG. 2**



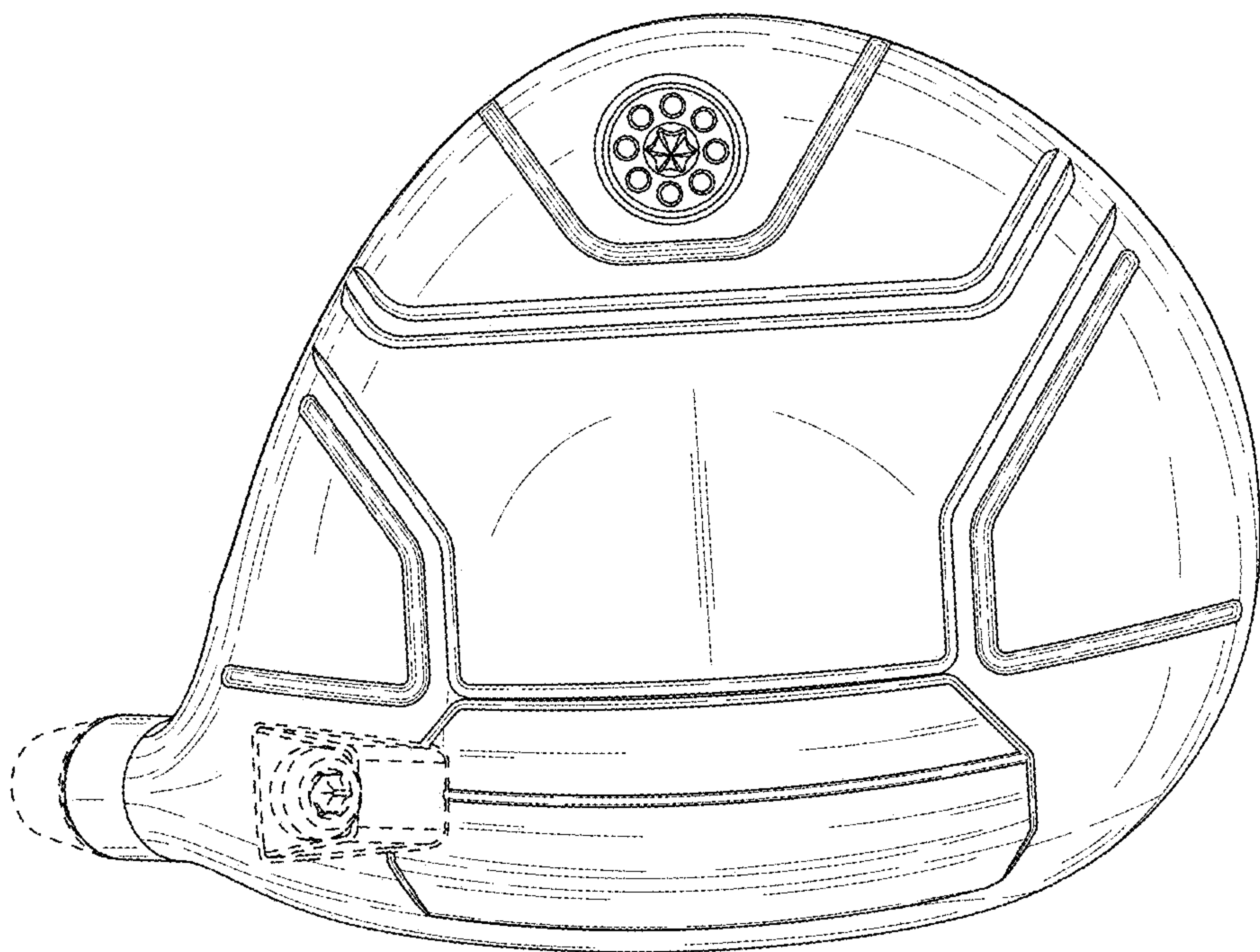
**FIG. 3**



**FIG. 4**

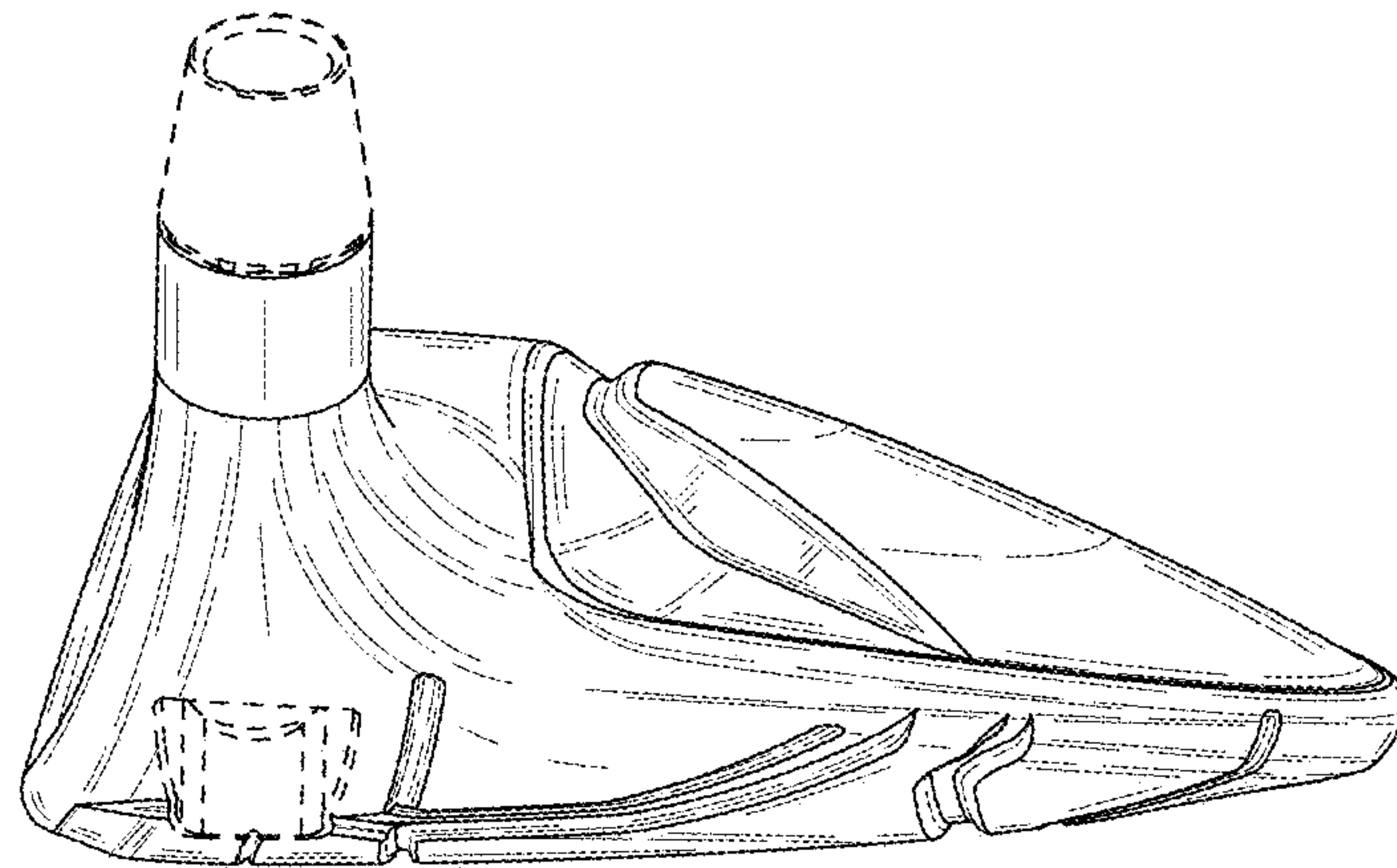


**FIG. 5**

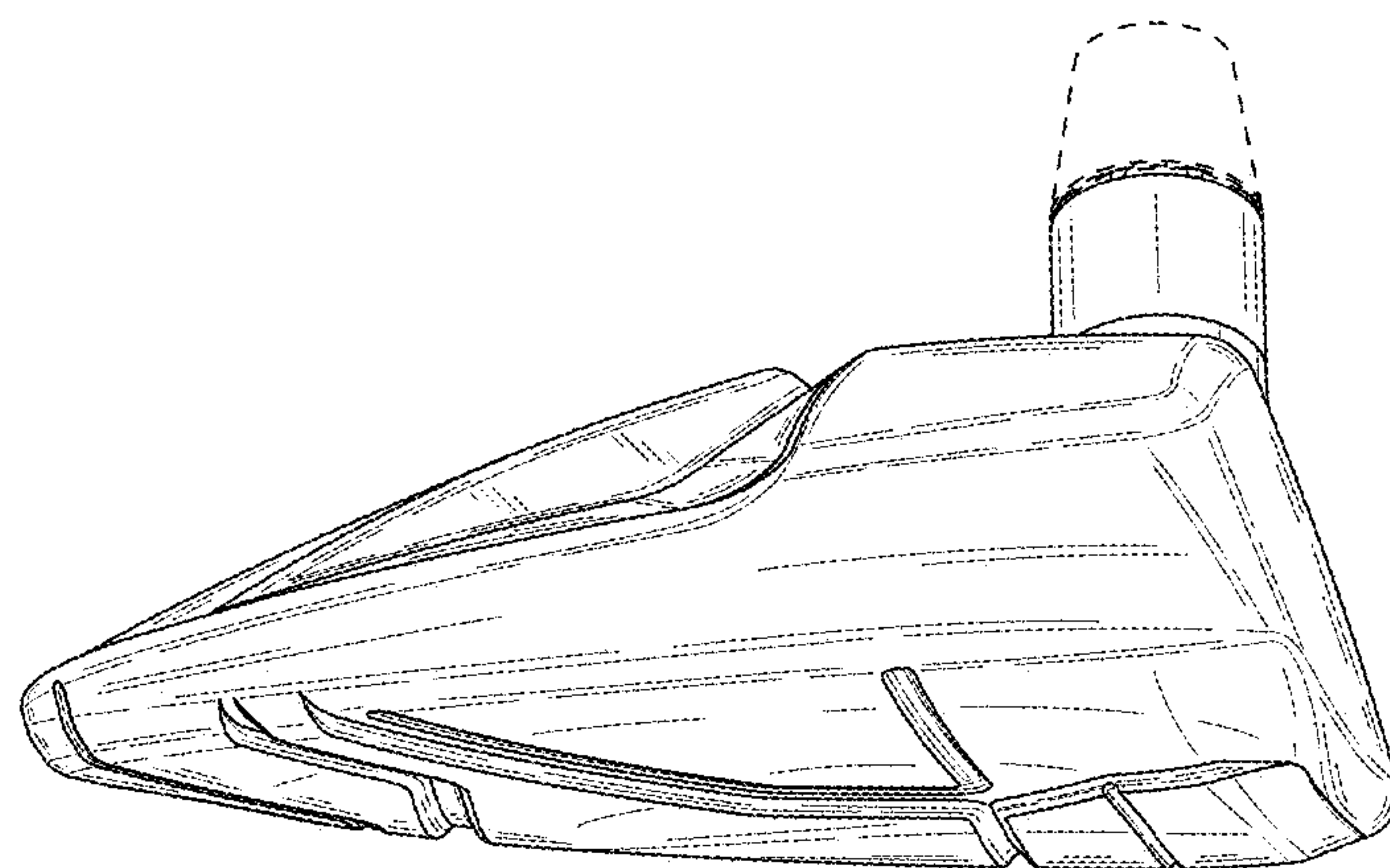


**FIG. 6**



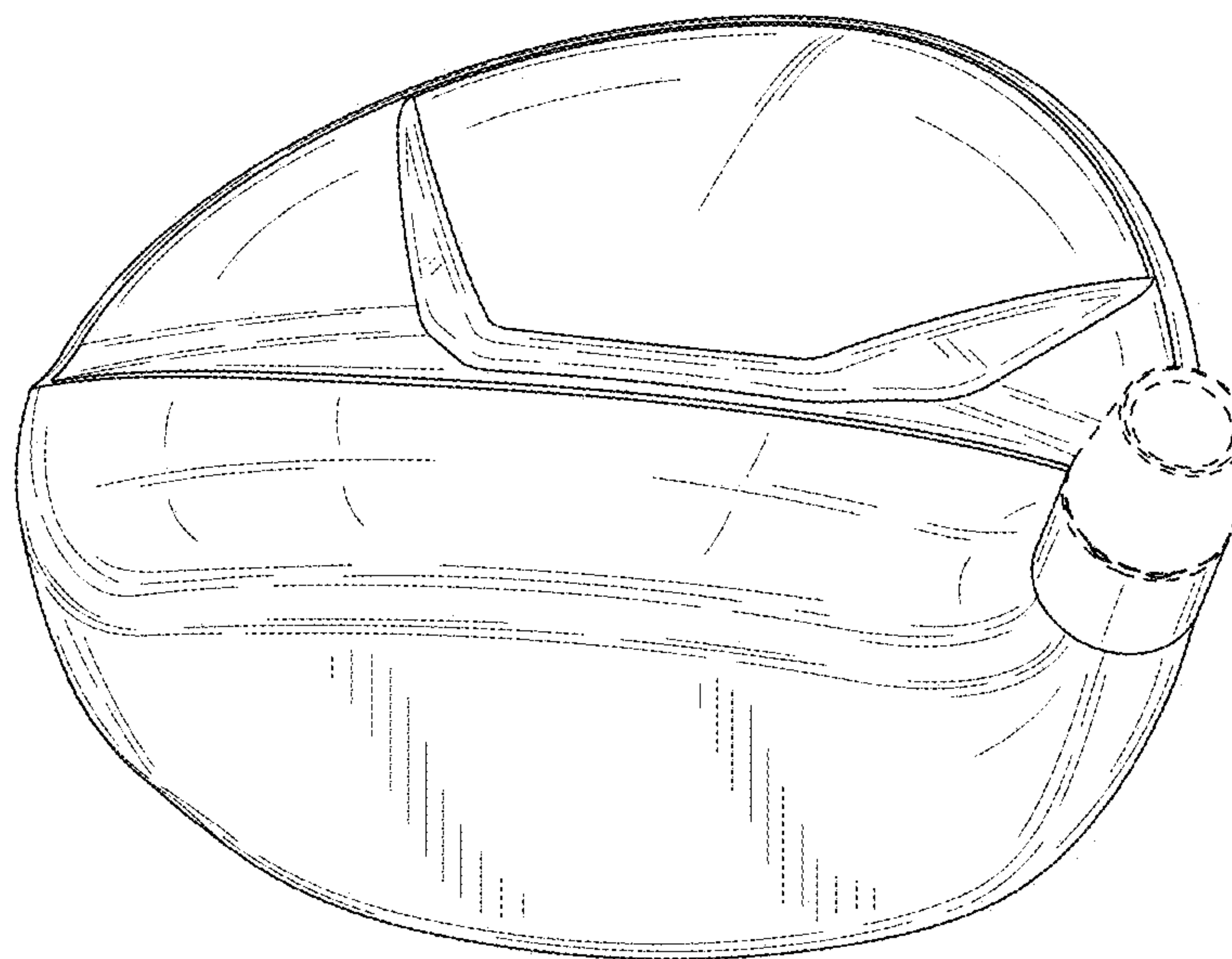


**FIG. 7**

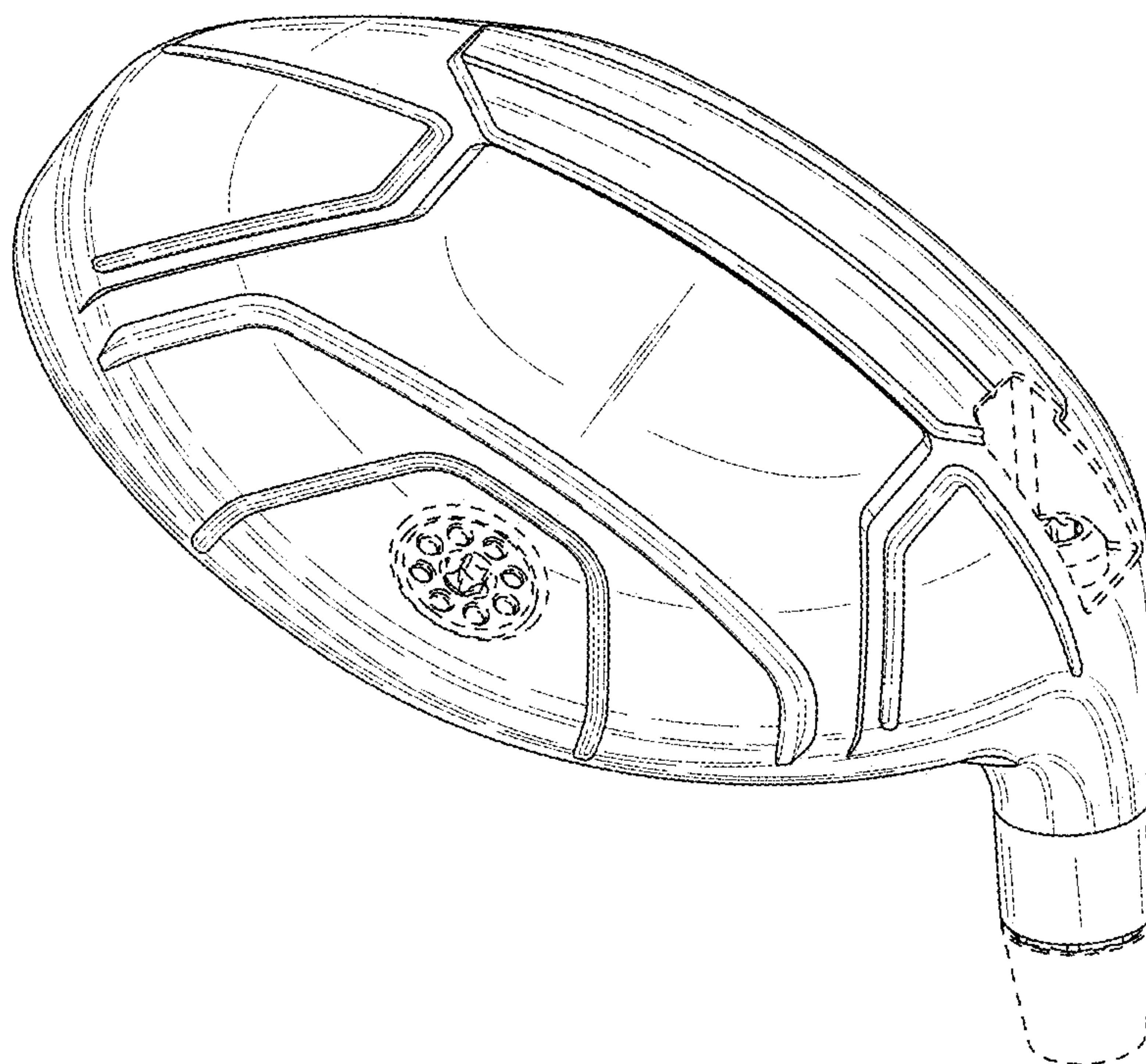


**FIG. 8**

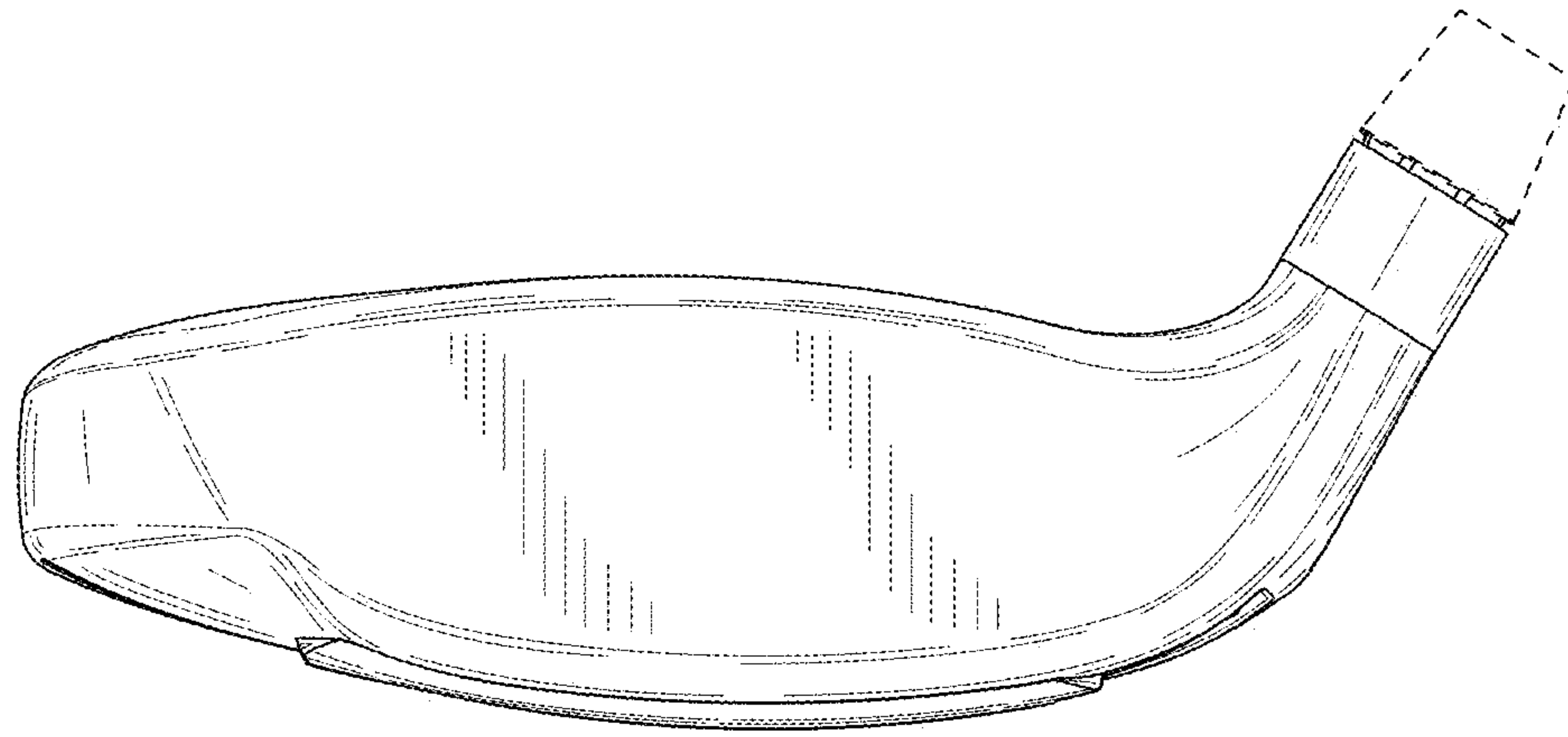




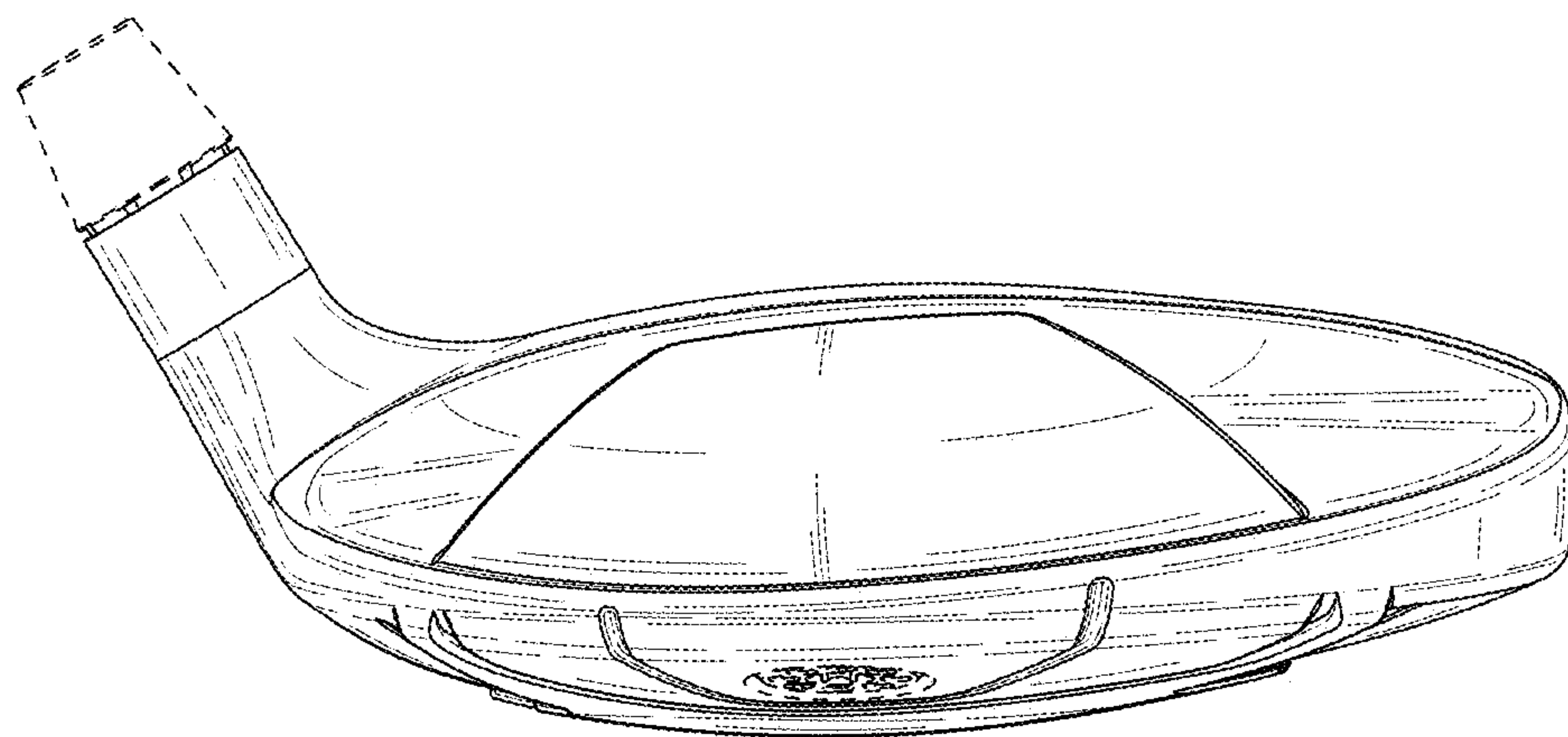
**FIG. 9**



**FIG. 10**

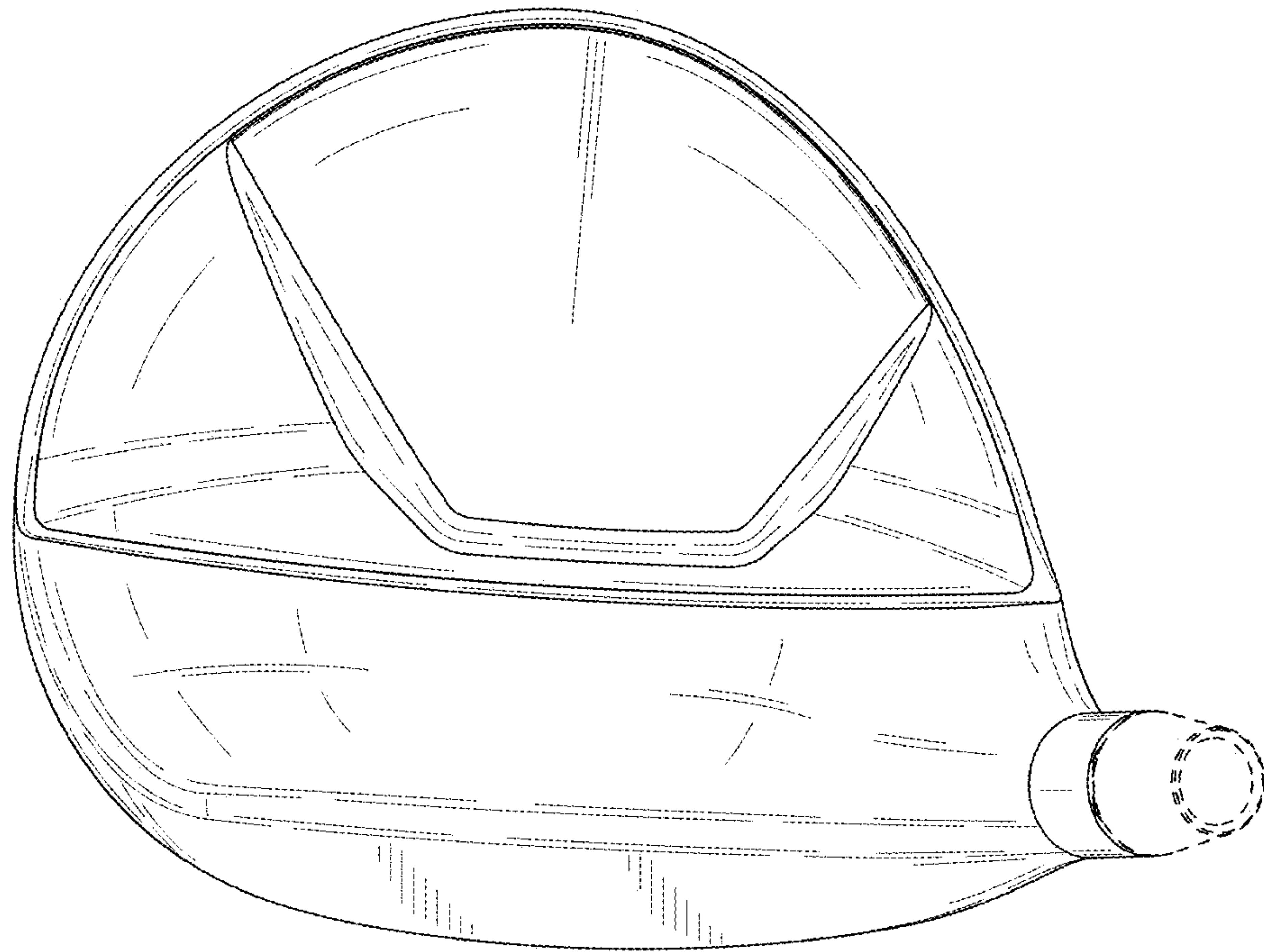


**FIG. 11**

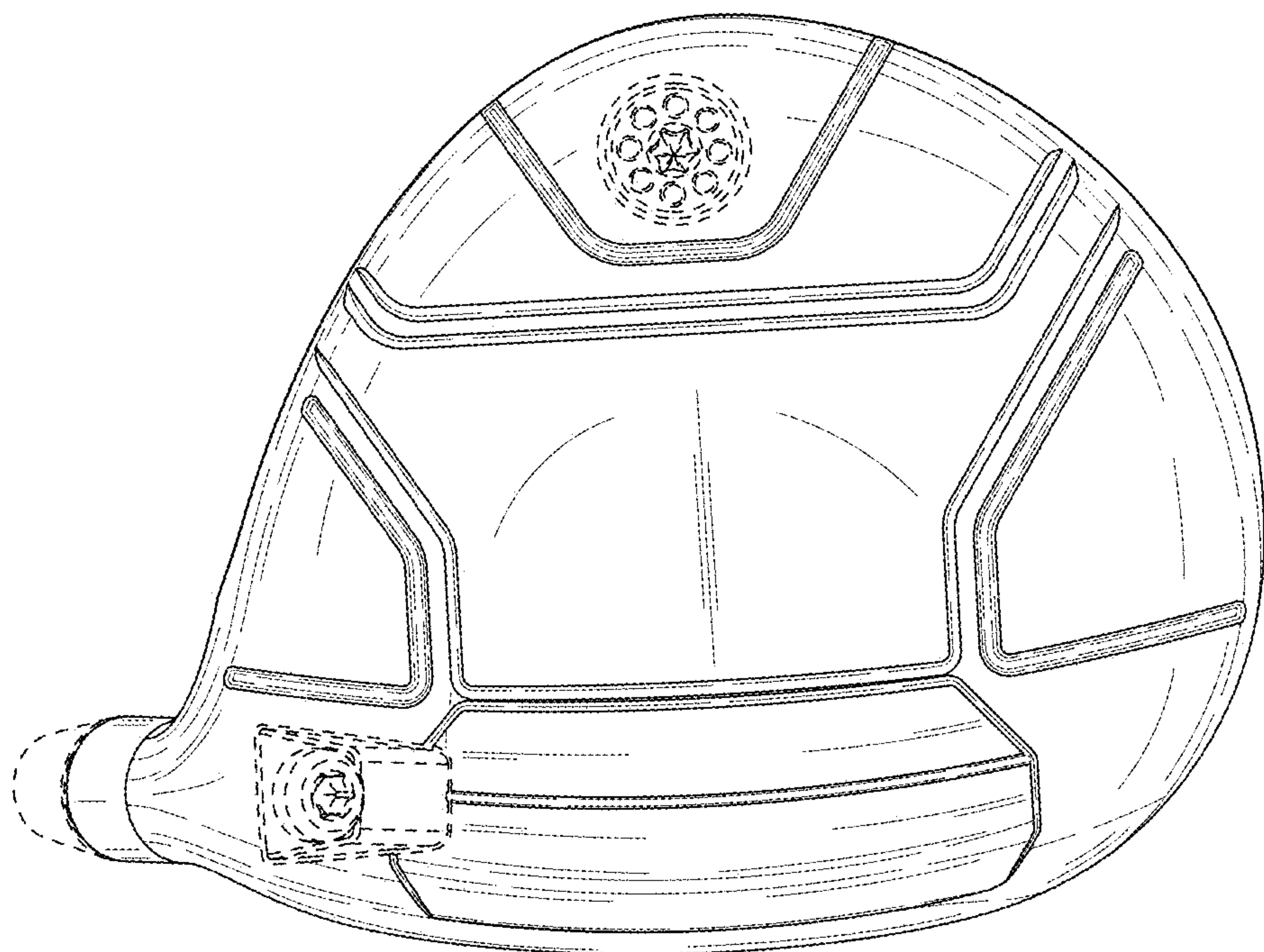


**FIG. 12**

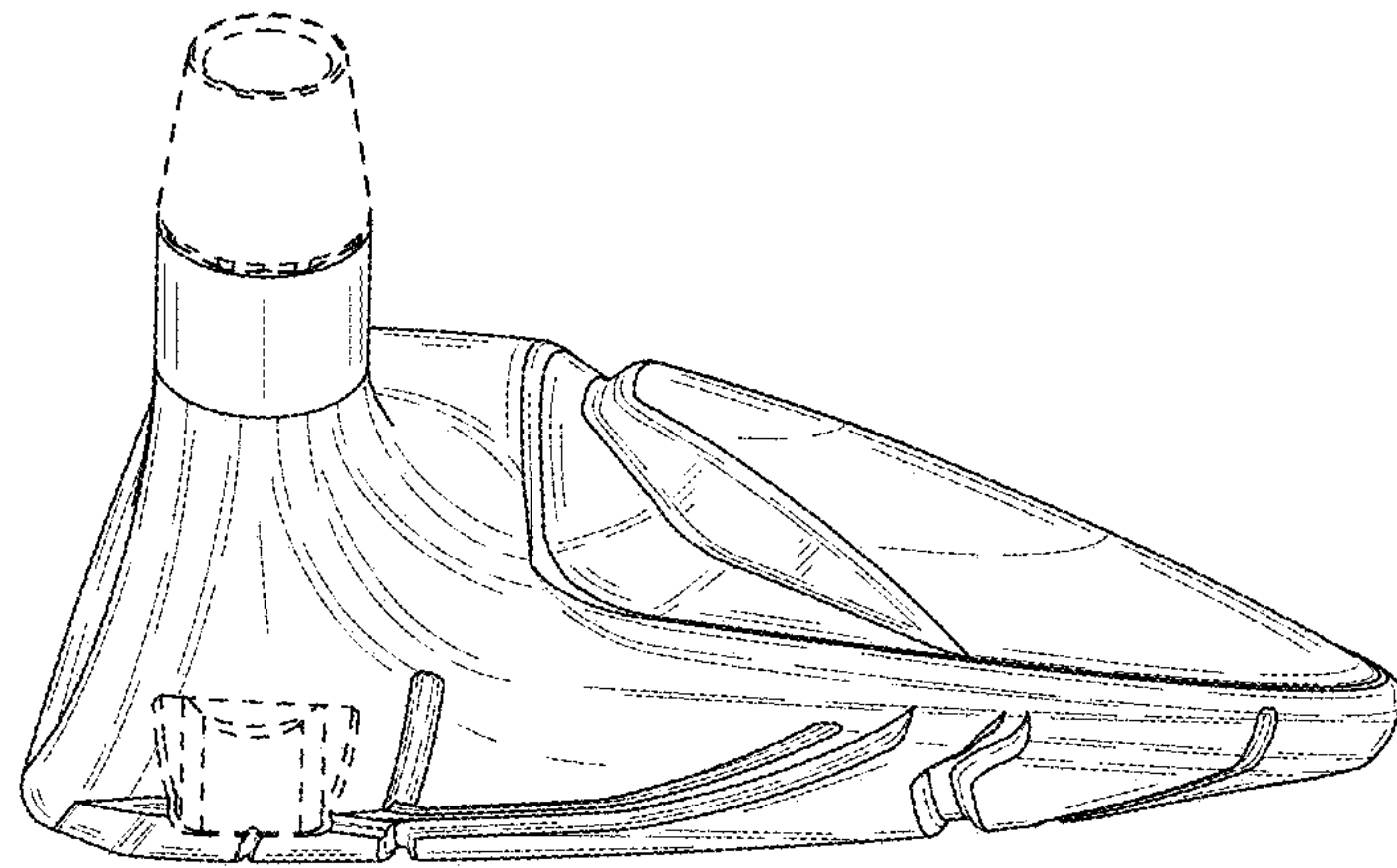




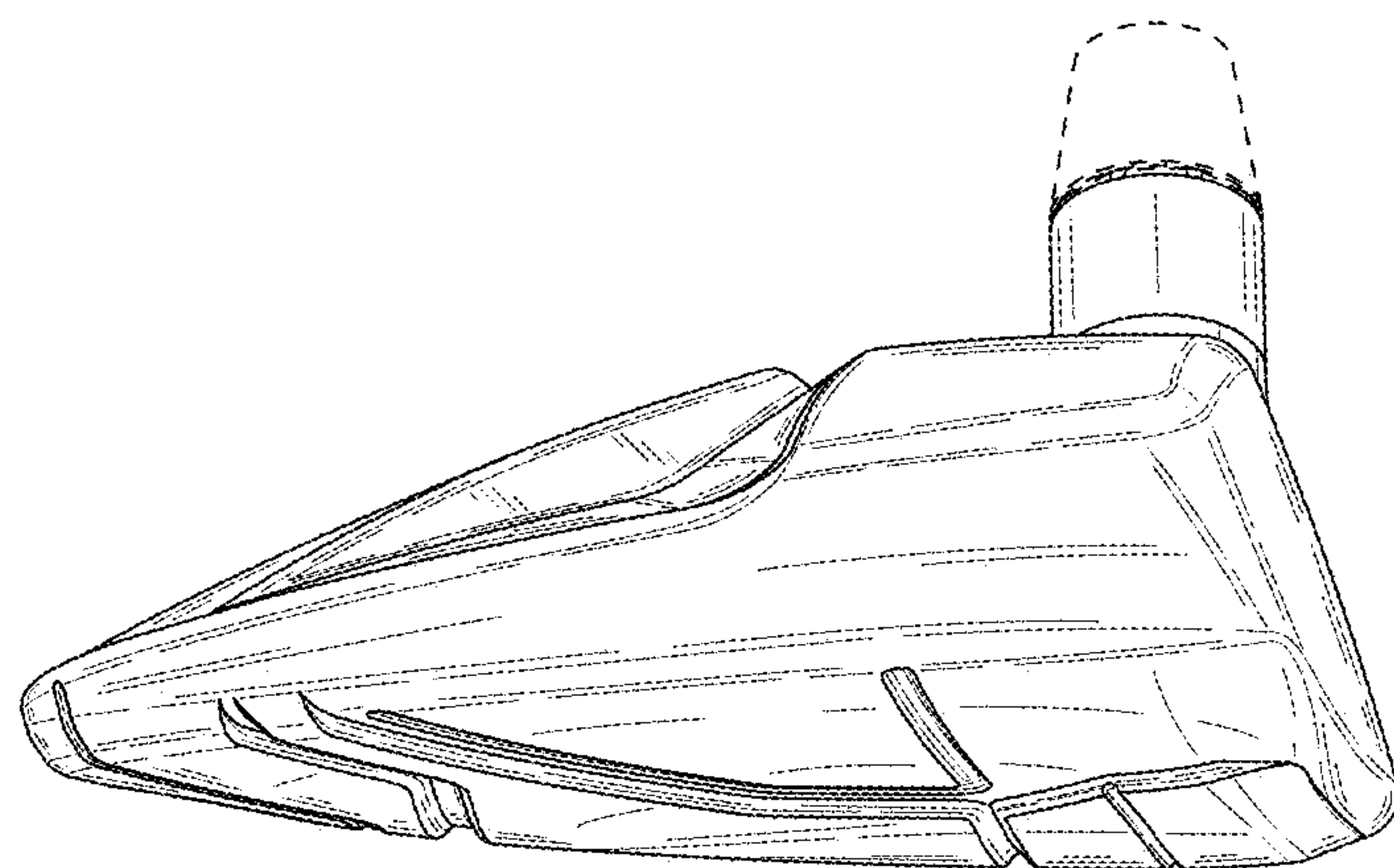
**FIG. 13**



**FIG. 14**



**FIG. 15**



**FIG. 16**