



US00D956749S

(12) **United States Design Patent** (10) **Patent No.:** **US D956,749 S**  
**De** (45) **Date of Patent:** **\*\* Jul. 5, 2022**

(54) **HEAD MOUNT DISPLAY**  
(71) Applicant: **Panasonic Intellectual Property Management Co., Ltd., Osaka (JP)**  
(72) Inventor: **Pinakesh De, Kyoto (JP)**  
(73) Assignee: **Panasonic Intellectual Property Management Co., Ltd., Osaka (JP)**

D859,407 S \* 9/2019 Natsume ..... D14/372  
D861,683 S 10/2019 Chou et al.  
D862,464 S \* 10/2019 Natsume ..... D14/372  
D875,729 S \* 2/2020 Natsume ..... D14/372  
D918,905 S \* 5/2021 Osterhout ..... D14/372  
D918,906 S \* 5/2021 Natsume ..... D14/372  
D931,854 S \* 9/2021 De ..... D14/372  
D931,855 S \* 9/2021 De ..... D14/372  
D944,246 S \* 2/2022 Natsume ..... D14/372  
D947,186 S \* 3/2022 Osterhout ..... D14/372  
2013/0235331 A1\* 9/2013 Heinrich ..... G02C 11/10  
351/158

(\*\*) Term: **15 Years**

(21) Appl. No.: **29/770,647**

(22) Filed: **Feb. 15, 2021**

(30) **Foreign Application Priority Data**

Nov. 4, 2020 (JP) ..... 2020-023785 D

(51) **LOC (13) Cl.** ..... **14-02**

(52) **U.S. Cl.**  
USPC ..... **D14/372**

(58) **Field of Classification Search**  
USPC ..... D14/372, 496, 432, 371, 125, 126, 129,  
D14/299; D16/300-342; 351/158, 153,  
351/144; 345/7-9, 905; 455/344;  
348/115, 53, 121, 739  
CPC ..... G02B 27/017; G02B 27/0158; G02B  
27/0161; G02B 27/0181; G02B 27/0185;  
G02B 27/0189

See application file for complete search history.

(56) **References Cited**

**U.S. PATENT DOCUMENTS**

D796,506 S \* 9/2017 Natsume ..... D14/372  
D840,396 S 2/2019 Zhou  
D845,296 S \* 4/2019 Natsume ..... D14/372  
D857,693 S \* 8/2019 Natsume ..... D14/372

**FOREIGN PATENT DOCUMENTS**

JP D1662752 6/2020

\* cited by examiner

*Primary Examiner* — Austin Murphy

(74) *Attorney, Agent, or Firm* — Panasonic IP Management; Kerry S. Culpepper

(57) **CLAIM**

I claim the ornamental design for a head mount display, as shown and described.

**DESCRIPTION**

FIG. 1 is a front perspective view of a head mount display of the present invention;

FIG. 2 is a rear perspective view thereof;

FIG. 3 is a front view thereof;

FIG. 4 is a rear view thereof;

FIG. 5 is a first side view thereof;

FIG. 6 is a second side view thereof;

FIG. 7 is a top view thereof; and,

FIG. 8 is a bottom view thereof.

The broken lines in the drawings represent portions of the head mount display that form no part of the claimed design.

**1 Claim, 8 Drawing Sheets**

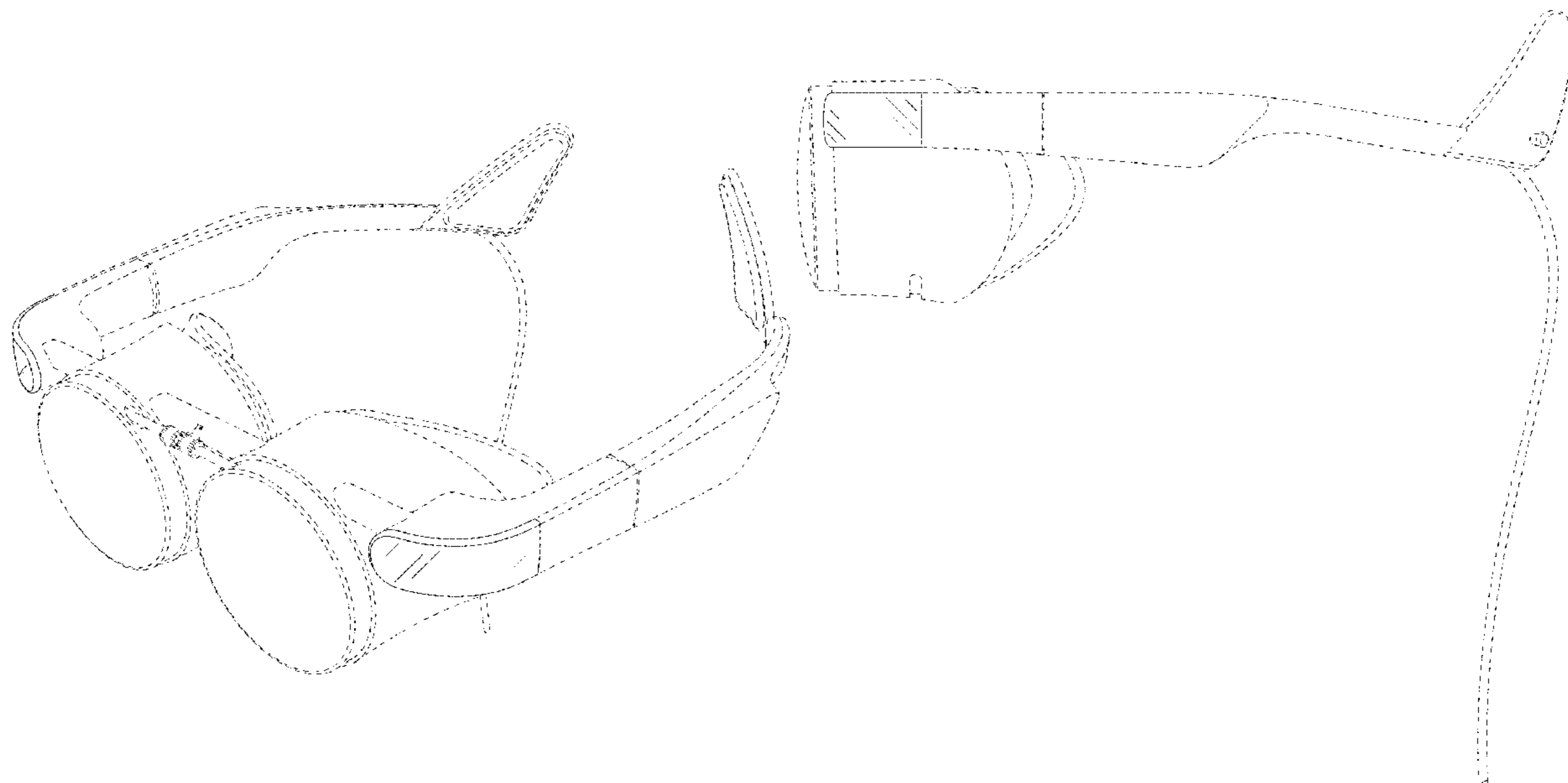

FIG. 1

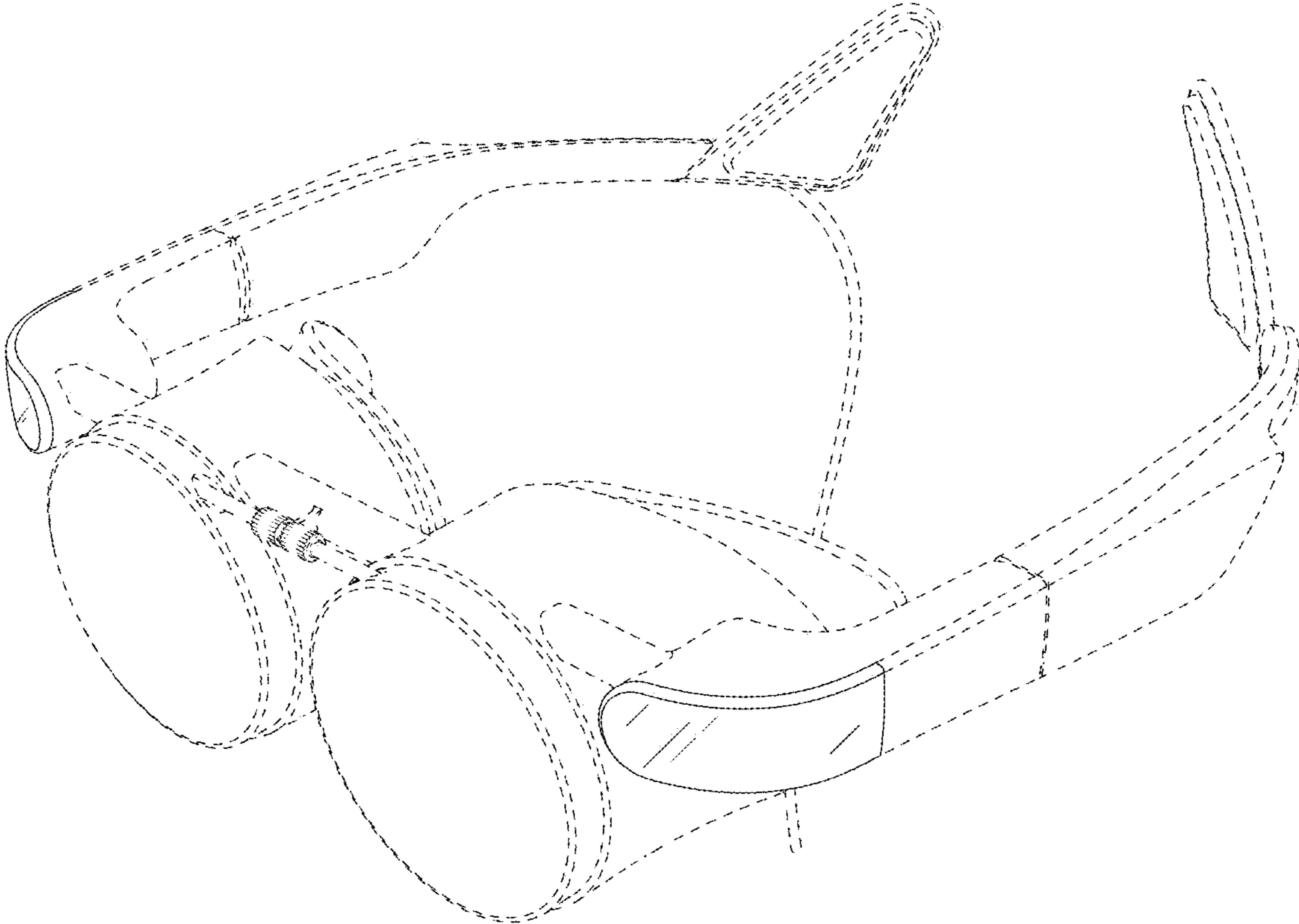

FIG. 2

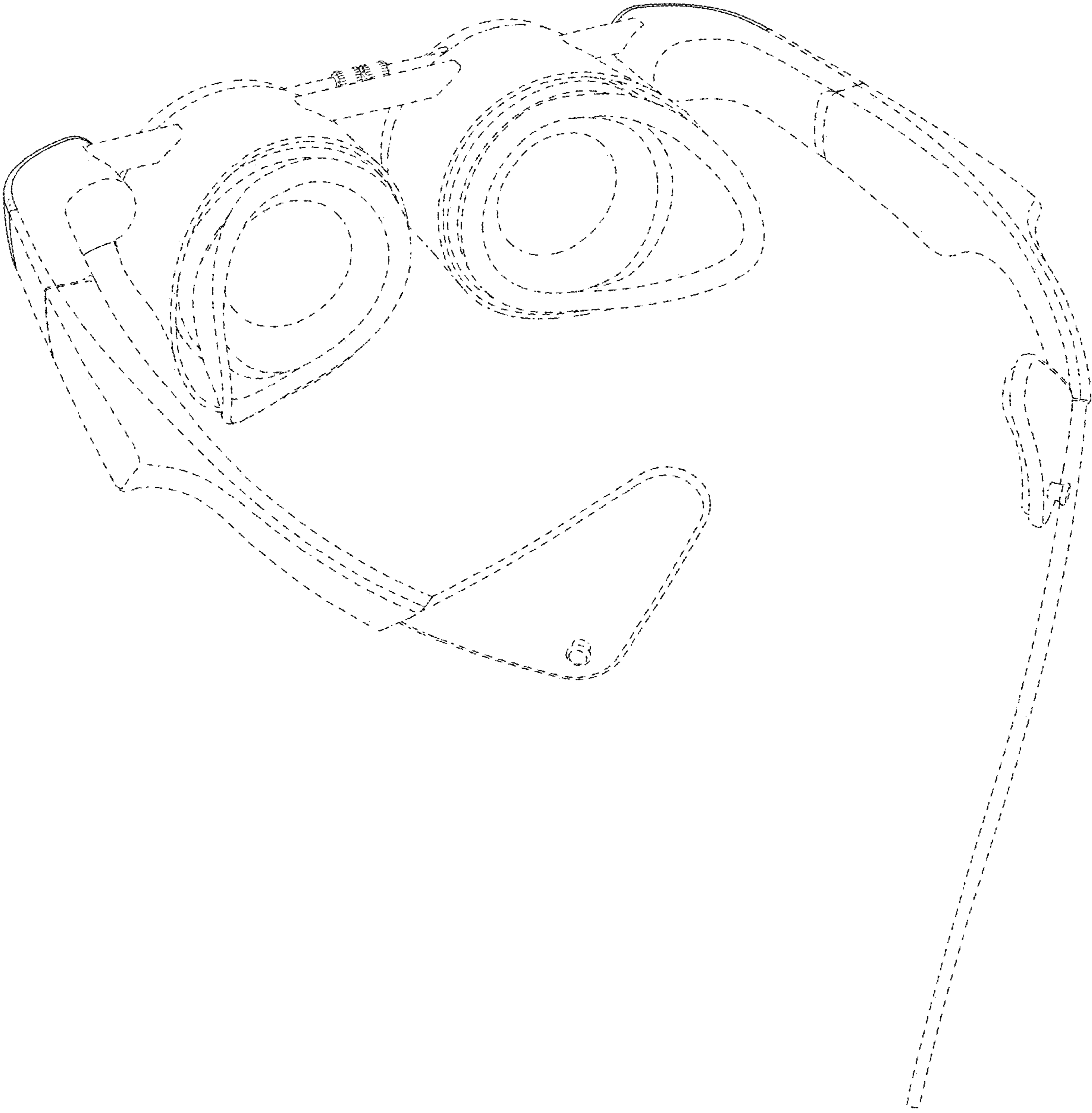

FIG. 3

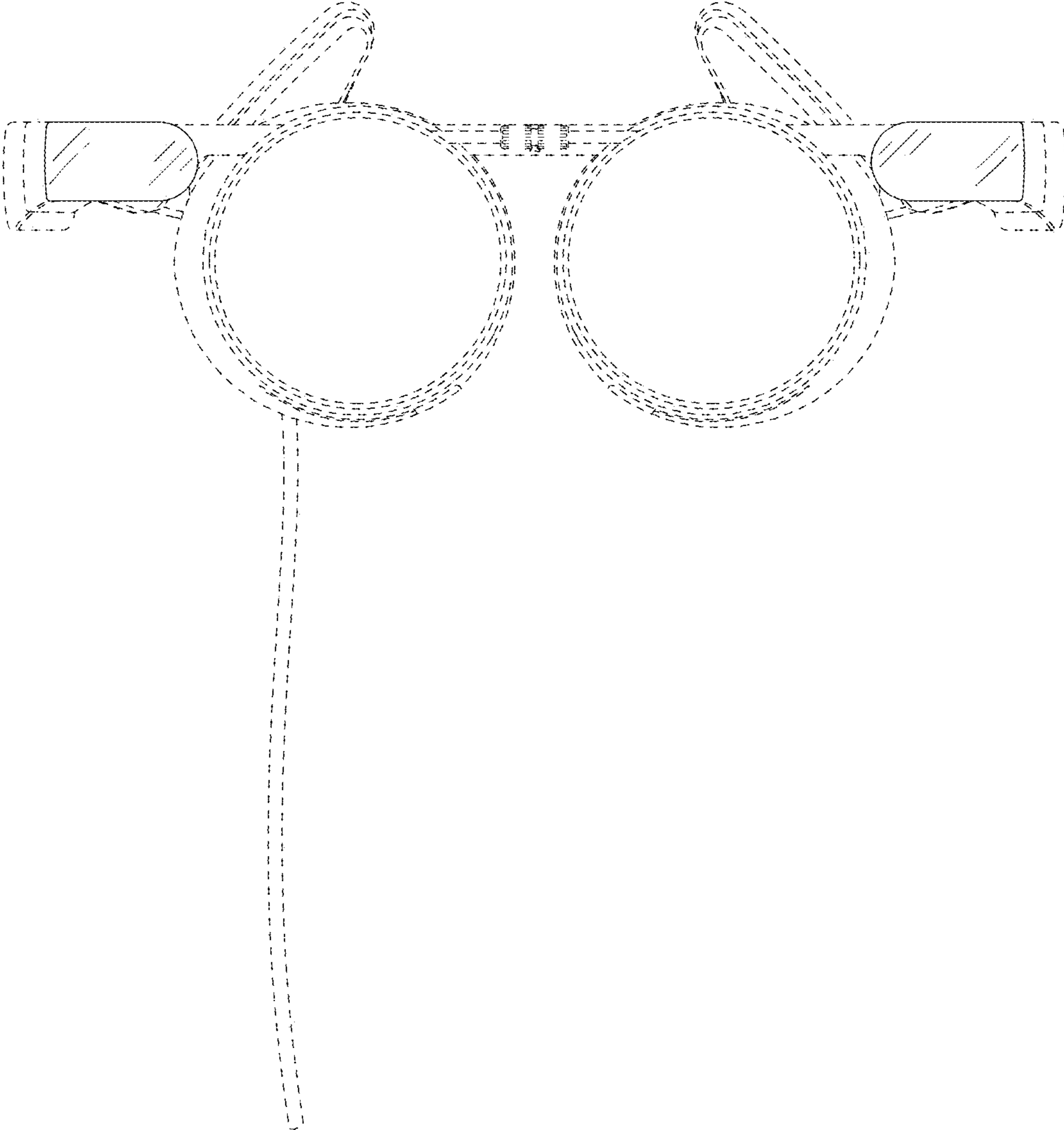

FIG. 4

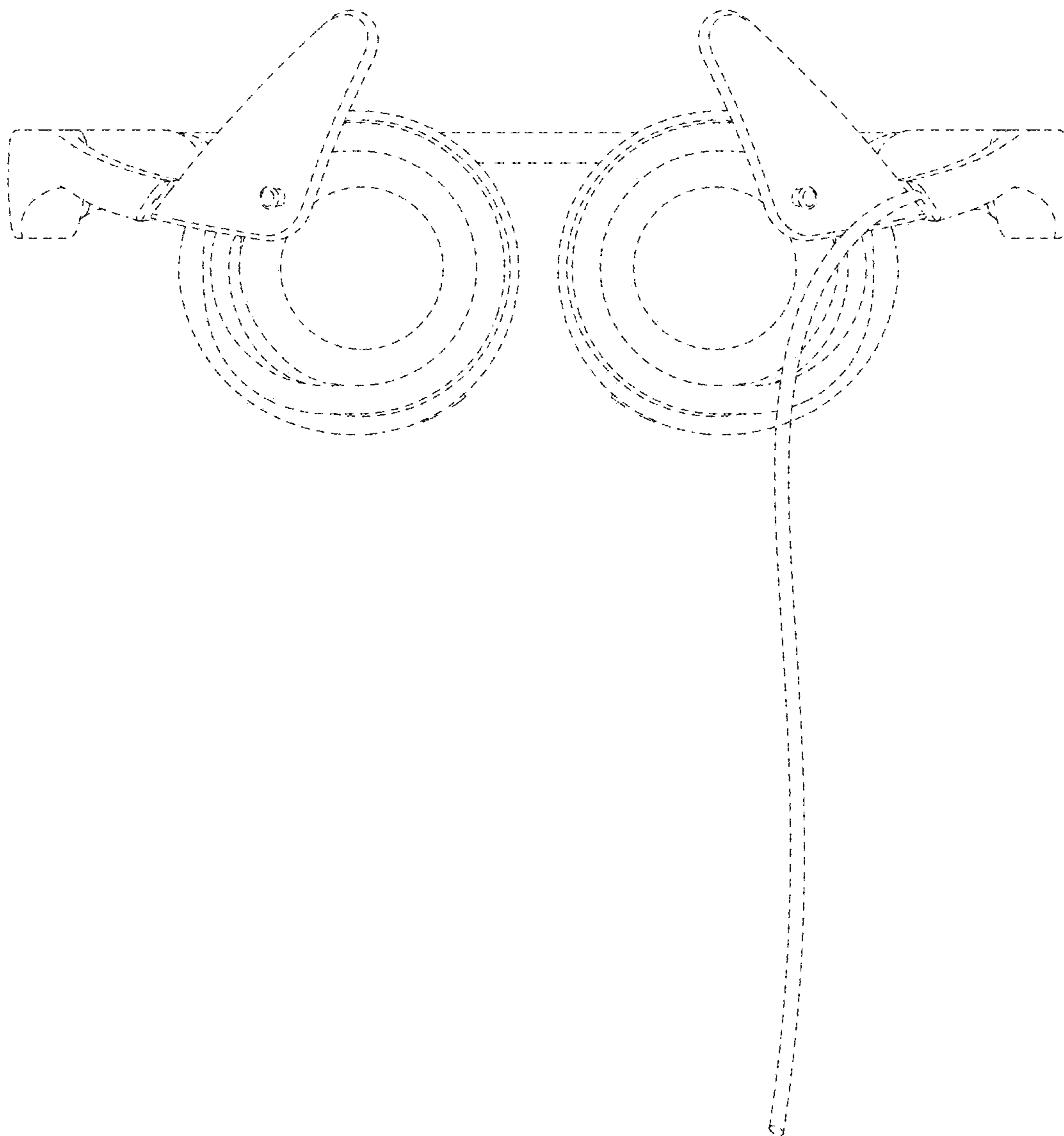

FIG. 5

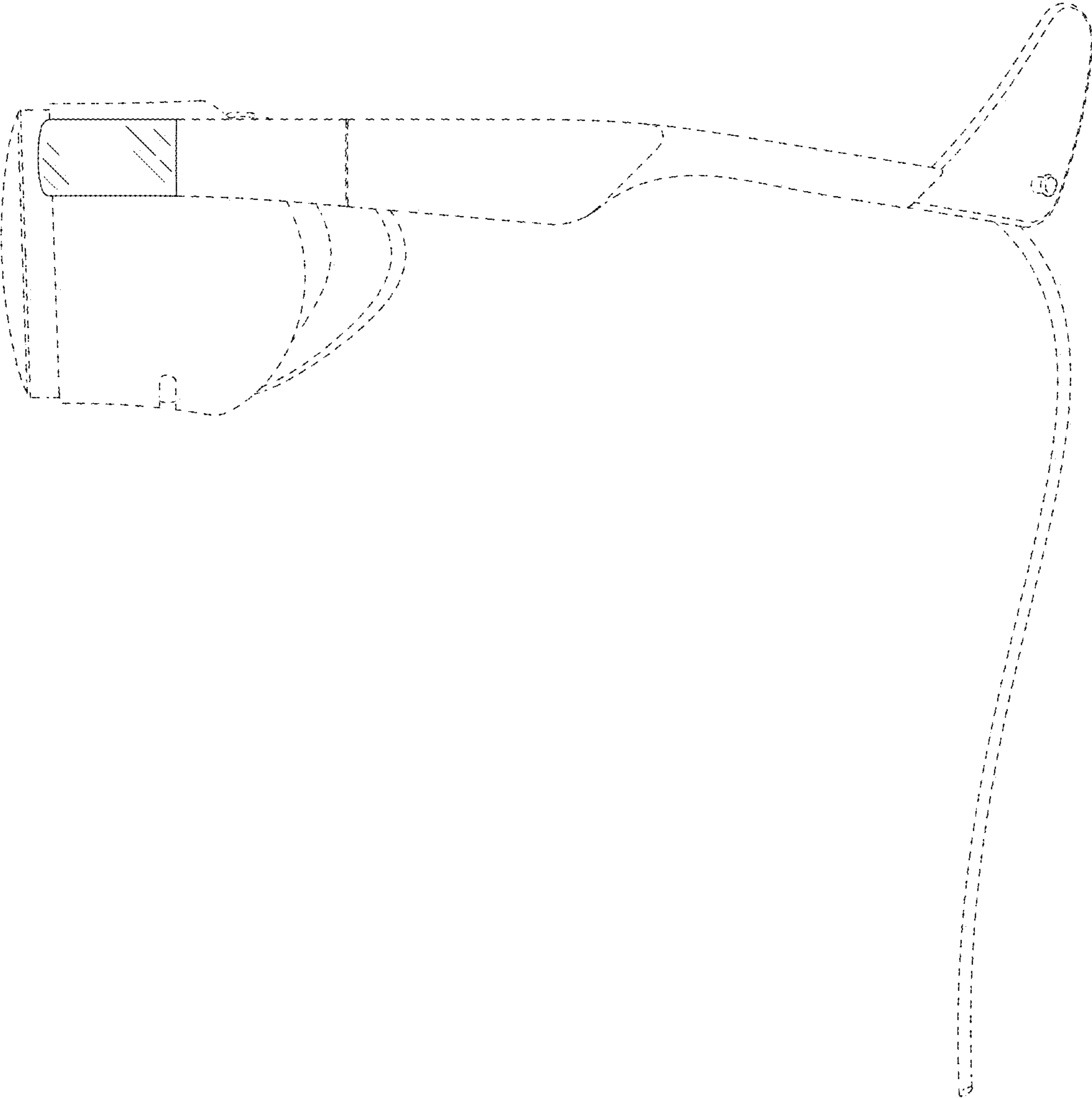

FIG. 6

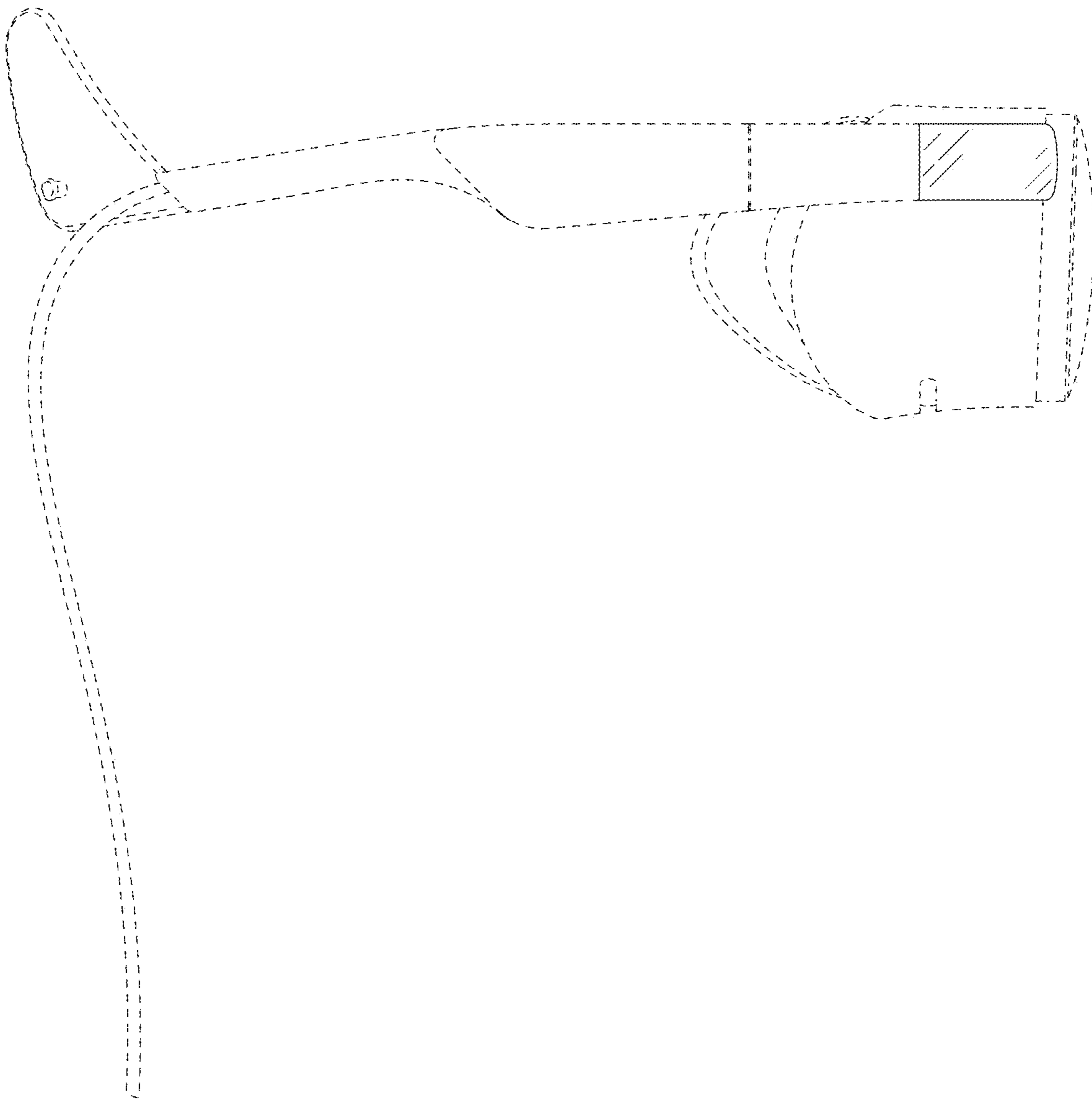

FIG. 7

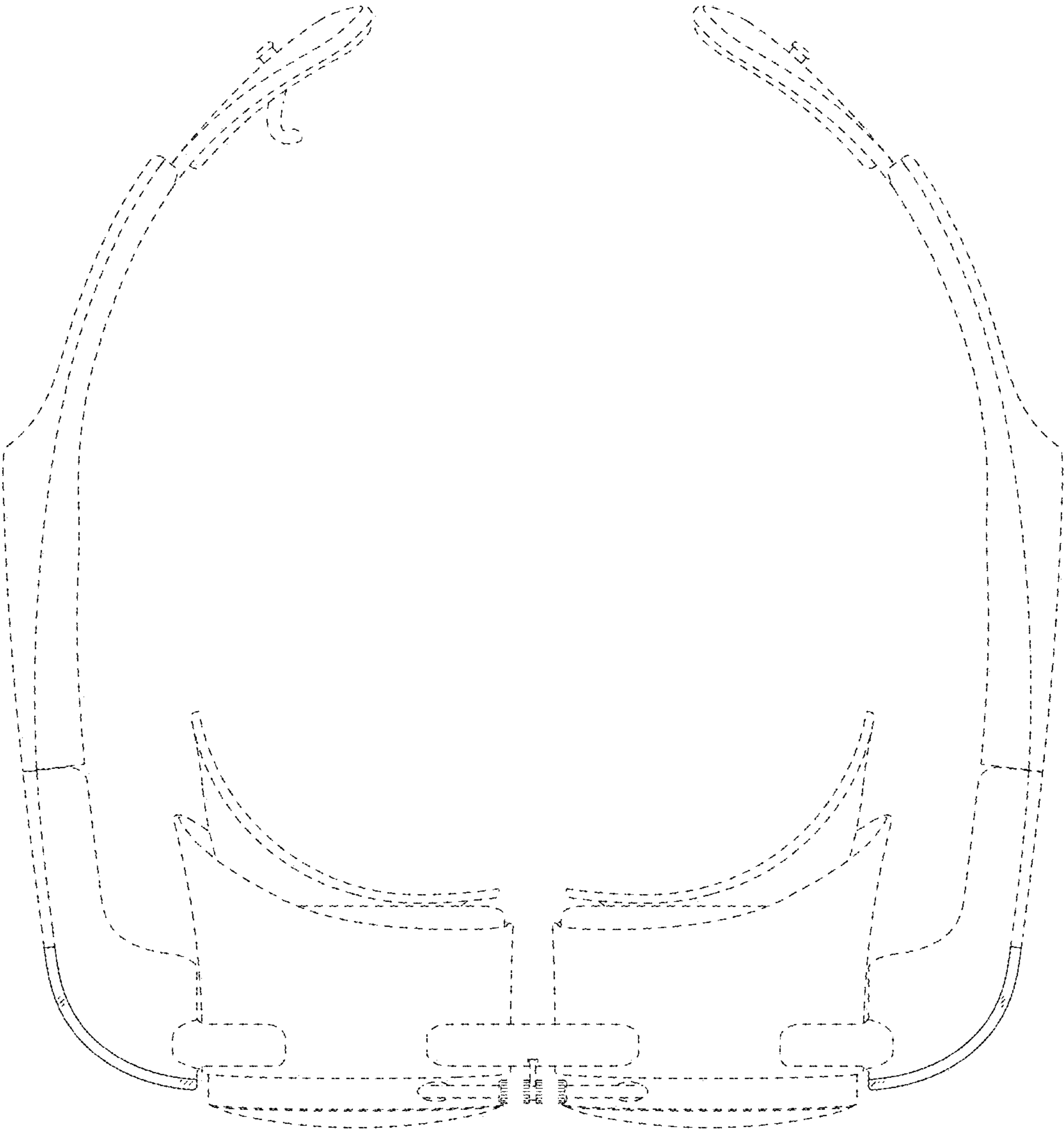



FIG. 8

