



US00D956725S

(12) **United States Design Patent**
Yang

(10) **Patent No.:** **US D956,725 S**
(45) **Date of Patent:** **** Jul. 5, 2022**

(54) **ANTENNA**

(71) Applicant: **Shenzhen Antop Technology Co. Ltd.**,
Guangdong (CN)

(72) Inventor: **Ruidian Yang**, Guangdong (CN)

(**) Term: **15 Years**

(21) Appl. No.: **29/718,980**

(22) Filed: **Dec. 31, 2019**

(30) **Foreign Application Priority Data**

Oct. 12, 2019 (CN) 201930556270.4

(51) **LOC (13) Cl.** **14-03**

(52) **U.S. Cl.**
USPC **D14/230**

(58) **Field of Classification Search**
USPC D14/230, 218; D21/658, 659, 712, 301,
D21/455, 436, 812, 781, 706, 478, 505;
D30/160

(Continued)

(56) **References Cited**

U.S. PATENT DOCUMENTS

D170,203 S * 8/1953 Leonard D14/230
3,434,145 A * 3/1969 Wells H01Q 9/265
343/726

(Continued)

FOREIGN PATENT DOCUMENTS

CN 304711113 * 7/2018
CN 304723184 * 7/2018

(Continued)

OTHER PUBLICATIONS

Antennas Direct, ClearStream 4 Outdoor UHF HDTV Antenna,
available at BJs.com, oldest review date 2013, site visited Mar. 8,

2022, Available at URL: <https://www.bjs.com/product/antennas-direct-clearstream-4-outdoor-uhf-hdtv-antenna/223844> (Year: 2013).*

(Continued)

Primary Examiner — Daniel J Domino

Assistant Examiner — Samina Vieth

(74) *Attorney, Agent, or Firm* — Prakash Nama; Global IP Services, PLLC

(57) **CLAIM**

The ornamental design for an antenna, as shown and described.

DESCRIPTION

FIG. 1 is a front view of a first embodiment of an antenna showing my new design;

FIG. 2 is a rear view thereof;

FIG. 3 is a left side view thereof;

FIG. 4 is a right side view thereof;

FIG. 5 is a top plan view thereof;

FIG. 6 is a bottom plan view thereof;

FIG. 7 is a perspective view thereof;

FIG. 8 is another perspective view thereof;

FIG. 9 is a front view of a second embodiment of an antenna showing my new design;

FIG. 10 is a rear view thereof;

FIG. 11 is a left side view thereof;

FIG. 12 is a right side view thereof;

FIG. 13 is a top plan view thereof;

FIG. 14 is a bottom plan view thereof;

FIG. 15 is a perspective view thereof;

FIG. 16 is another perspective view thereof;

FIG. 17 is a front view of a third embodiment of an antenna showing my new design;

FIG. 18 is a rear view thereof;

FIG. 19 is a left side view thereof;

FIG. 20 is a right side view thereof;

FIG. 21 is a top plan view thereof;

FIG. 22 is a bottom plan view thereof;

FIG. 23 is a perspective view thereof;

FIG. 24 is another perspective view thereof;

FIG. 25 is a front view of a fourth embodiment of an antenna showing my new design;

(Continued)

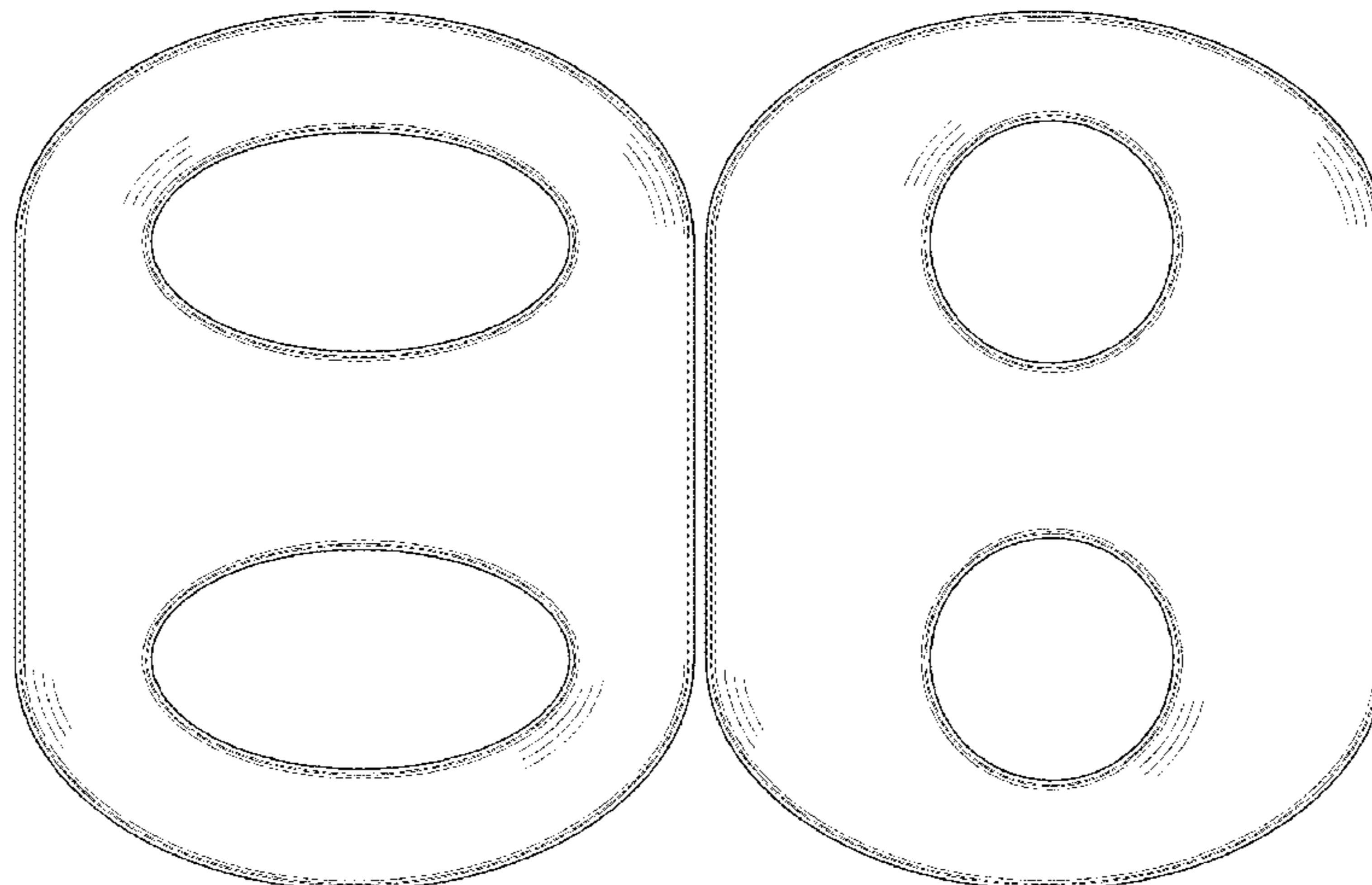

FIG. 26 is a rear view thereof;
 FIG. 27 is a left side view thereof;
 FIG. 28 is a right side view thereof;
 FIG. 29 is a top plan view thereof;
 FIG. 30 is a bottom plan view thereof;
 FIG. 31 is a perspective view thereof;
 FIG. 32 is another perspective view thereof;
 FIG. 33 is a front view of a fifth embodiment of an antenna showing my new design;
 FIG. 34 is a rear view thereof;
 FIG. 35 is a left side view thereof;
 FIG. 36 is a right side view thereof;
 FIG. 37 is a top plan view thereof;
 FIG. 38 is a bottom plan view thereof;
 FIG. 39 is a perspective view thereof; and,
 FIG. 40 is another perspective view thereof.

1 Claim, 40 Drawing Sheets

(58) **Field of Classification Search**

CPC B60R 13/005; H01Q 9/28; H01Q 7/00;
 H01Q 19/138; H01Q 19/106; H01Q
 19/005

See application file for complete search history.

(56) **References Cited**

U.S. PATENT DOCUMENTS

D585,883 S * 2/2009 Kaneko D14/230
 D598,005 S * 8/2009 Amano D14/209.1
 D598,434 S * 8/2009 Schneider D14/230
 8,599,079 B2 * 12/2013 Kudo H01Q 1/3291
 343/773
 D699,228 S * 2/2014 Ferguson D14/230
 D709,865 S * 7/2014 Ferguson D14/230
 D804,459 S * 12/2017 Feit D14/230
 D809,490 S * 2/2018 Feit D14/230
 D820,373 S * 6/2018 Czane D21/698
 D831,622 S * 10/2018 Yang D14/230
 D837,188 S * 1/2019 Yang D14/230
 D837,769 S * 1/2019 Yang D14/230
 D838,698 S * 1/2019 Yang D14/230
 D839,981 S * 2/2019 Czane D21/698
 D847,798 S * 5/2019 Yang D14/230
 D849,722 S * 5/2019 Yang D14/230

D850,425 S * 6/2019 Yang D14/230
 D851,175 S * 6/2019 Warther D20/22
 D852,172 S * 6/2019 Wu D14/230
 D867,347 S * 11/2019 Ross, III D14/230
 D872,714 S * 1/2020 Yang D14/230
 D881,172 S * 4/2020 Ross, III D14/230
 D883,264 S * 5/2020 Ross, III D14/230
 D883,265 S * 5/2020 Feit D14/230
 D888,697 S * 6/2020 Ross, III D14/230
 D892,096 S * 8/2020 Feit D14/230
 D896,791 S * 9/2020 Yang D14/230
 D896,792 S * 9/2020 Yang D14/230
 D896,793 S * 9/2020 Yang D14/230
 D896,794 S * 9/2020 Yang D14/230
 D896,797 S * 9/2020 Yang D14/230
 D901,464 S * 11/2020 Yang D14/230
 D901,465 S * 11/2020 Yang D14/230
 D901,466 S * 11/2020 Yang D14/230
 D902,896 S * 11/2020 Feit D14/230
 D909,350 S * 2/2021 Zhou D14/230
 D918,187 S * 5/2021 Feit D14/230
 D938,944 S * 12/2021 Yang D14/230
 D940,695 S * 1/2022 Yang D14/230
 2007/0200769 A1 * 8/2007 Nakano H01Q 1/48
 343/846
 2021/0066797 A1 * 3/2021 Li H01Q 3/247

FOREIGN PATENT DOCUMENTS

CN 305240692 * 7/2019
 CN 305766716 * 5/2020
 CN 305766719 * 5/2020

OTHER PUBLICATIONS

Rocketfish, Outdoor Amplified HDTV Antenna—Grey, available at bestbuy.com, oldest review date 2019, site visited Mar. 7, 2022, Available at URL: <https://www.bestbuy.com/site/rocketfish-outdoor-amplified-hdtv-antenna-gray/5976403.p?skuId=5976403&ref=212&loc=1&extStoreId=1092> (Year: 2019).*

UltraPro Store, Quadcore TV Antenna . . . , available at amazon.com, date first available Mar. 26, 2021, site visited Mar. 22, 2022, Available at URL: <https://www.amazon.com/GE-Quadcore-Supports-Weatherproof-48896/dp/B0917565C8?th=1> (Year: 2021).*

Antennas Direct, ClearStream 2V TV Antenna . . . , available at amazon.com, date first available Apr. 4, 2012, site visited Mar. 8, 2022, Available at URL: https://www.amazon.com/Antennas-Direct-ClearStream-Multi-directional-Adjustable/dp/B007RH5GZI/ref=psdc_10966881_t2_B0917565C8 (Year: 2012).*

* cited by examiner

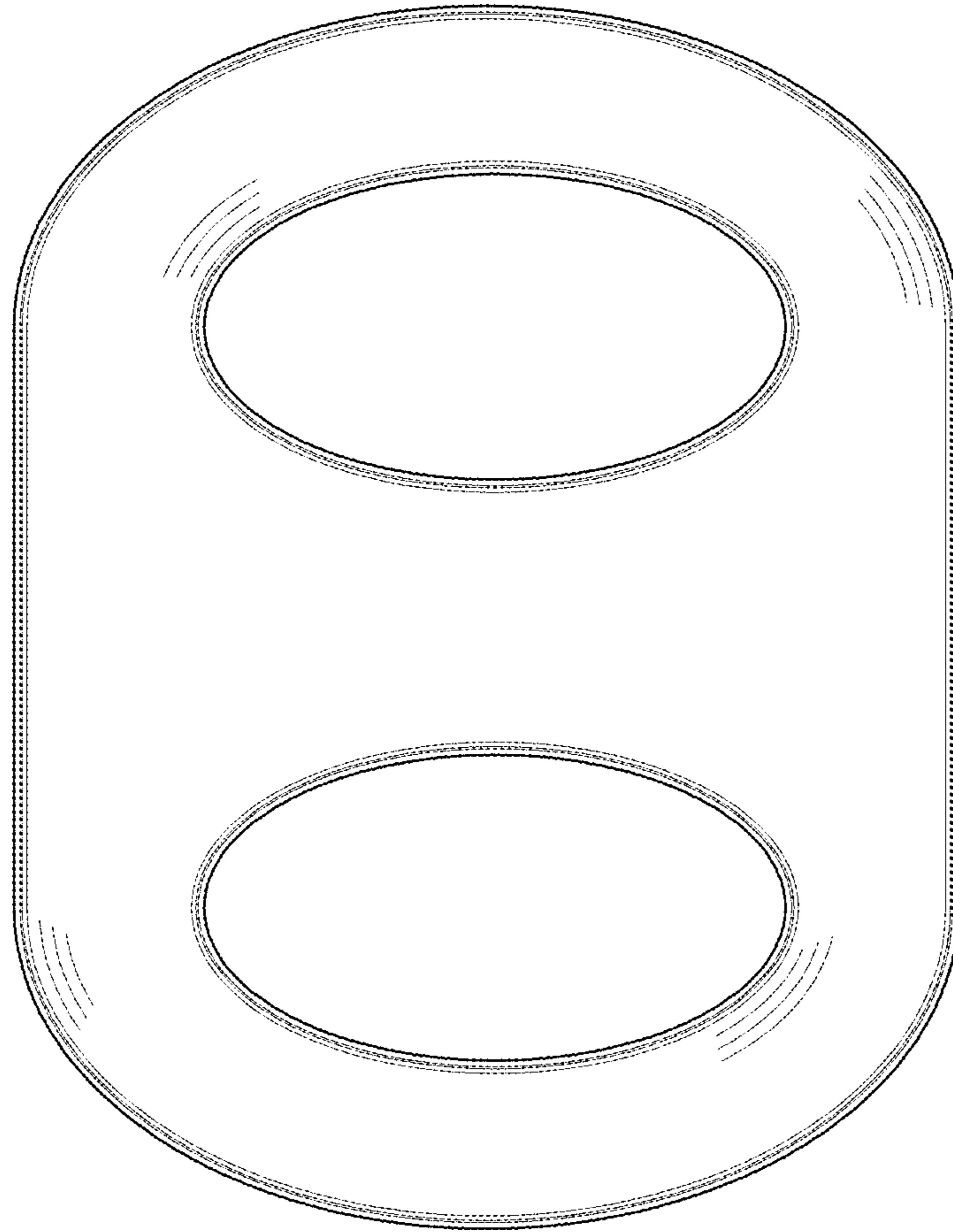

FIG.1

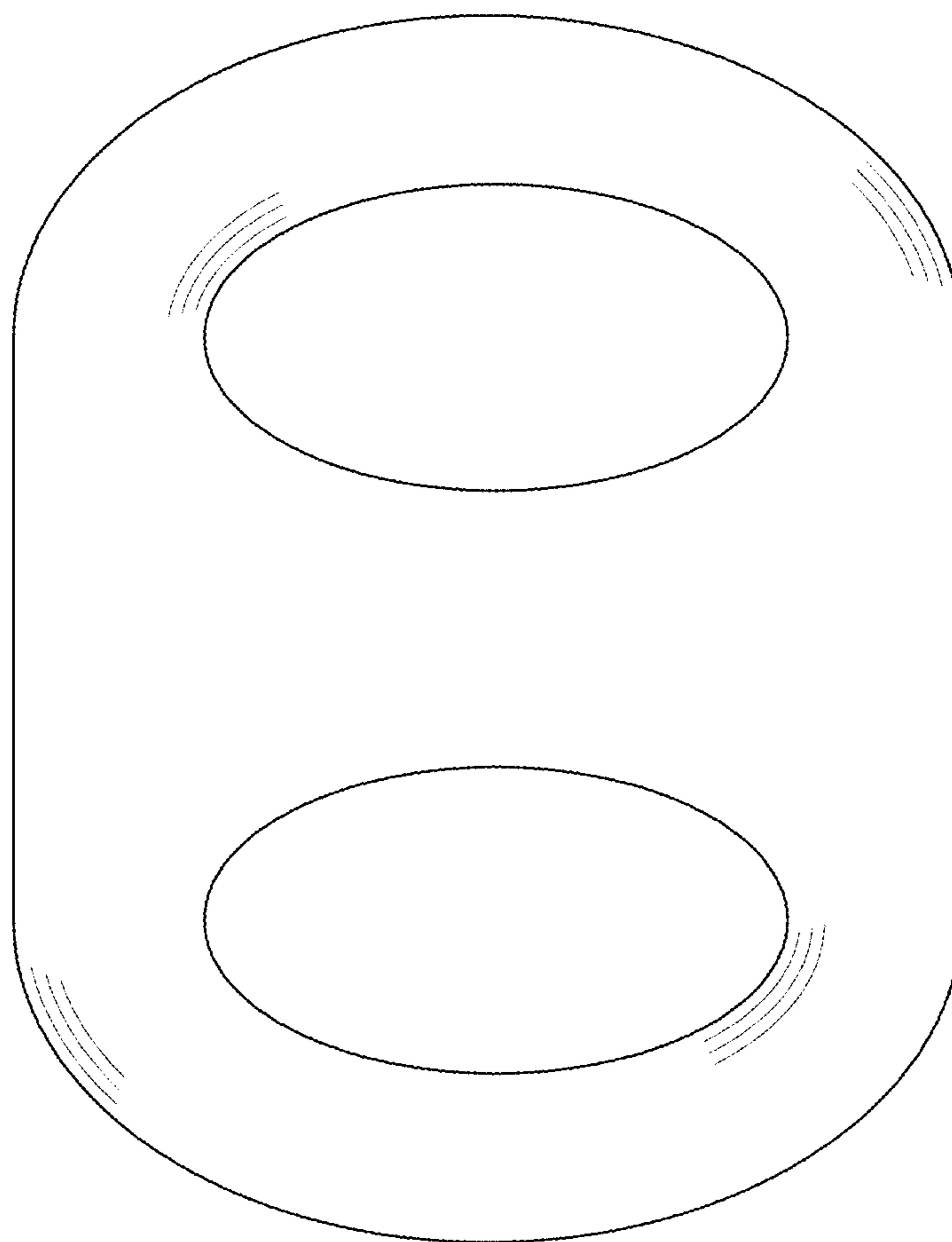

FIG.2



FIG.3

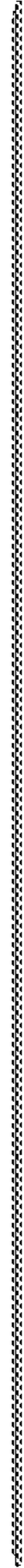

FIG.4



FIG.5

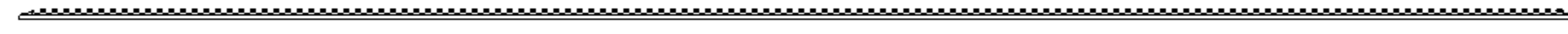

FIG.6

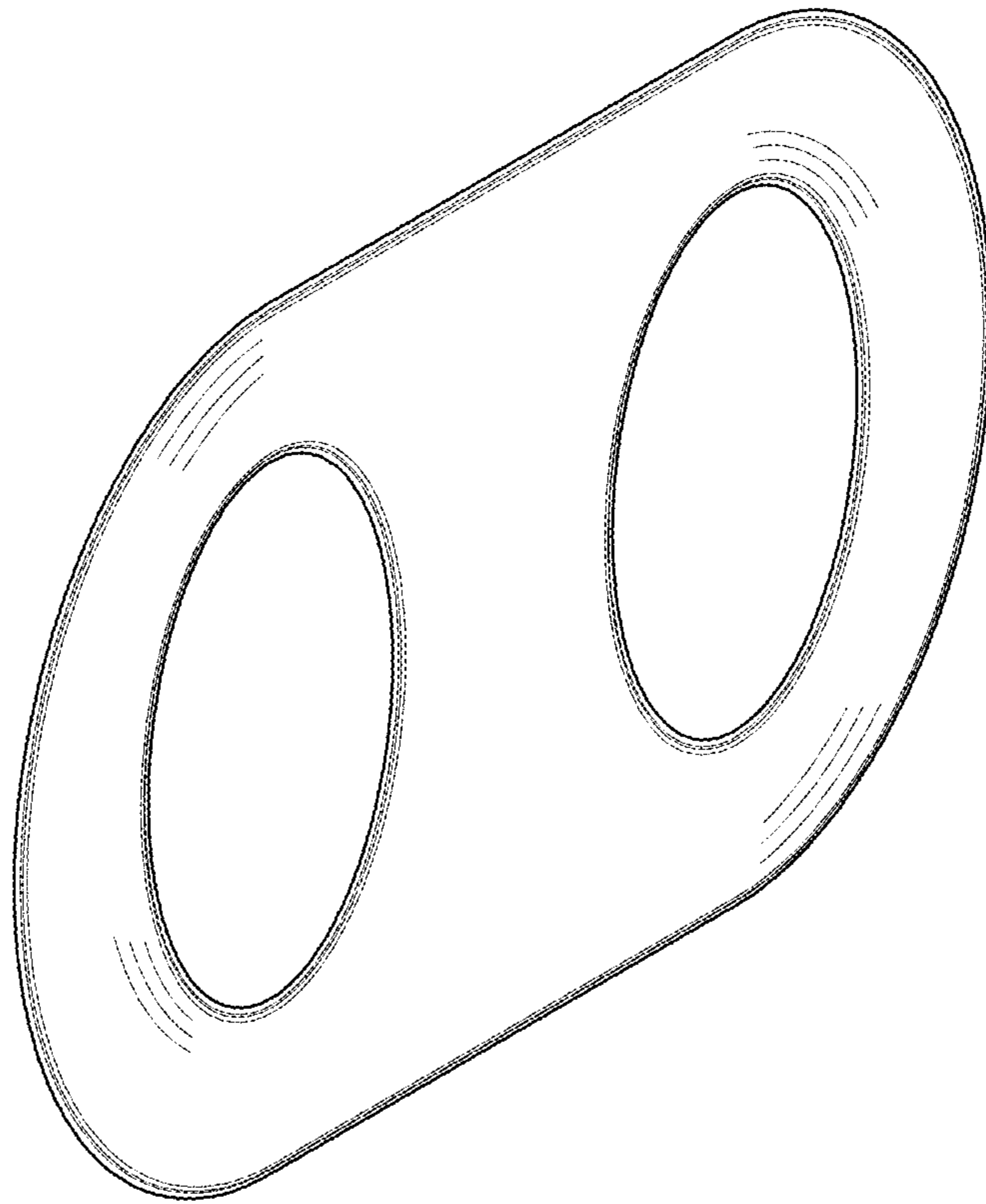

FIG.7

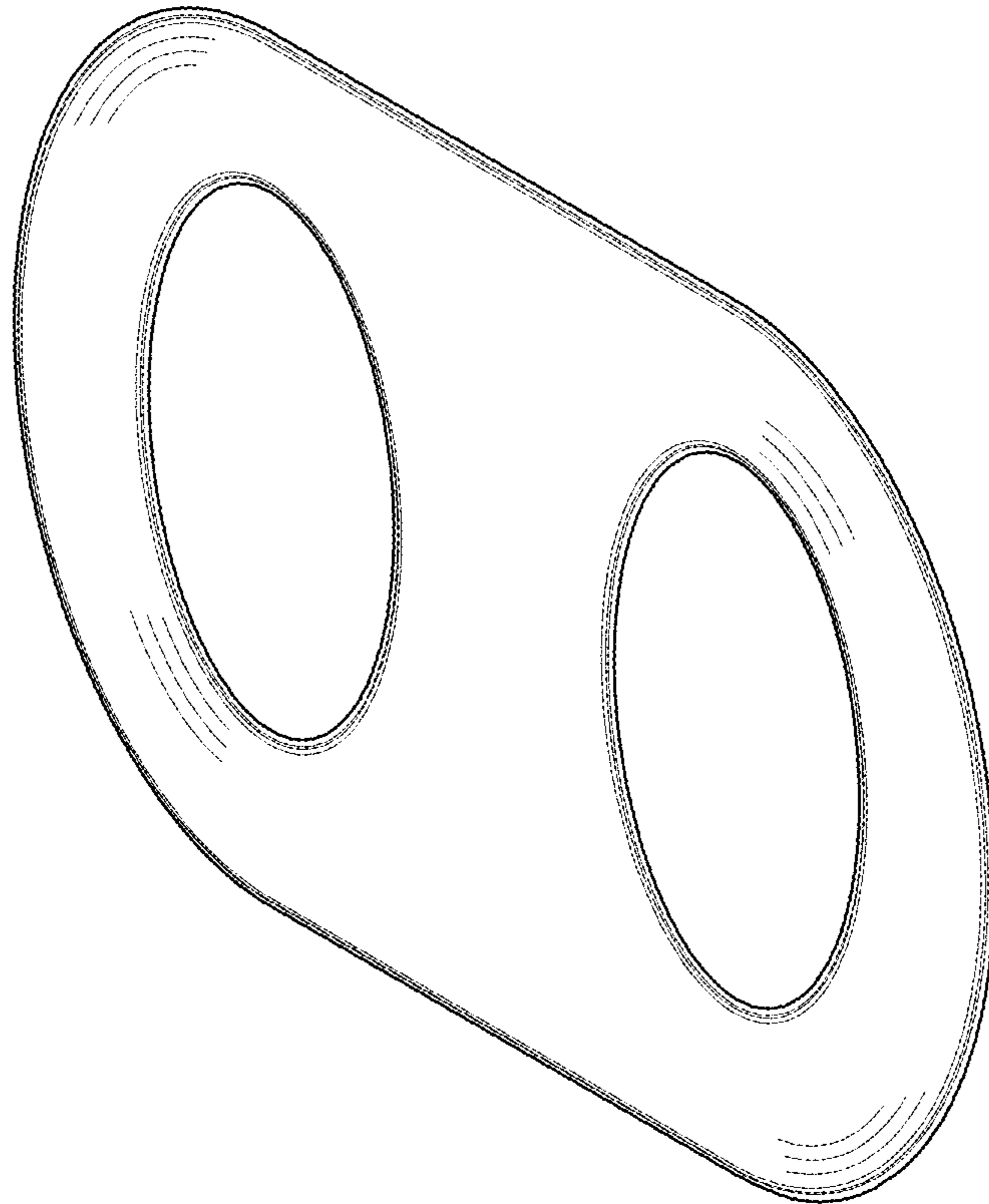

FIG.8

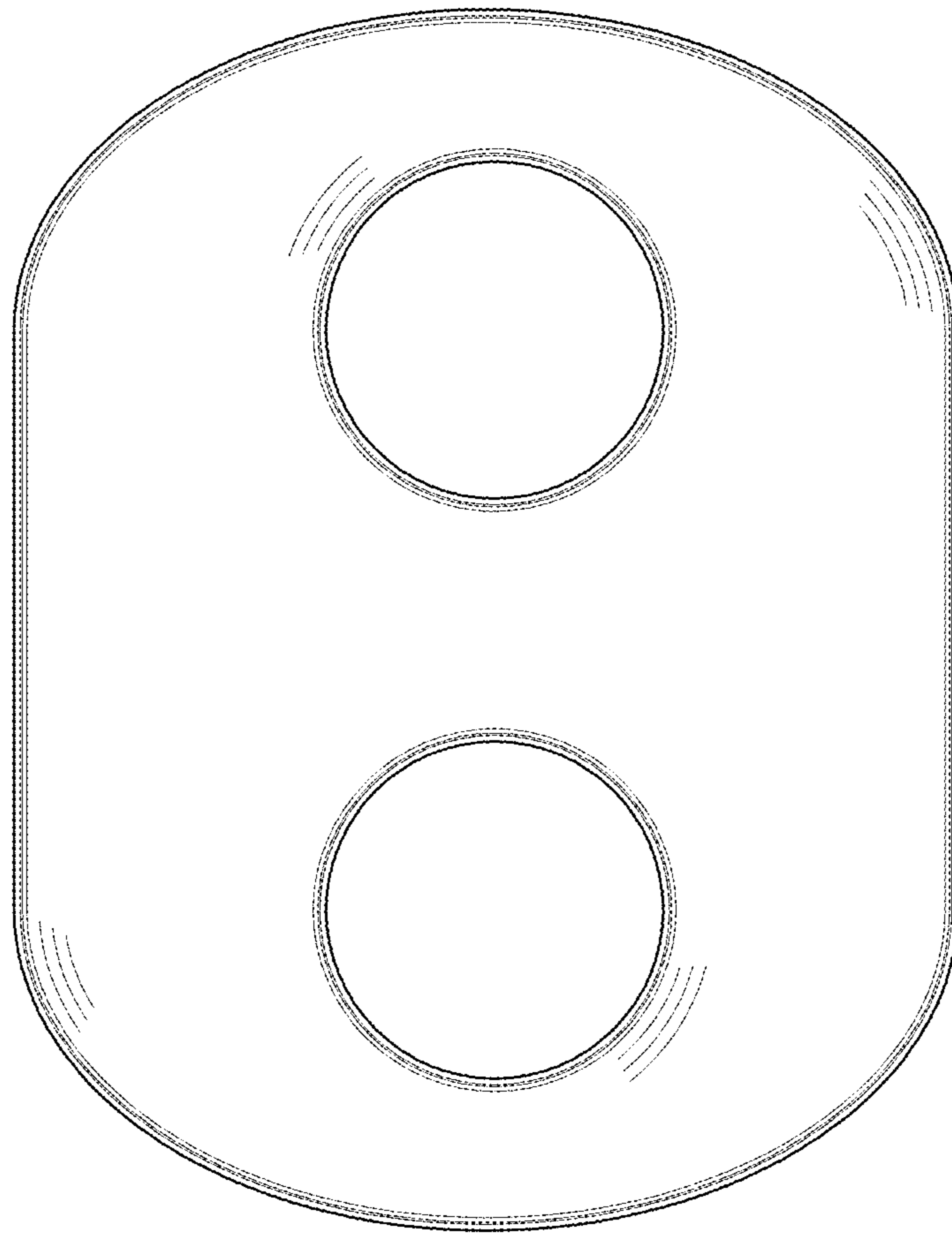

FIG.9

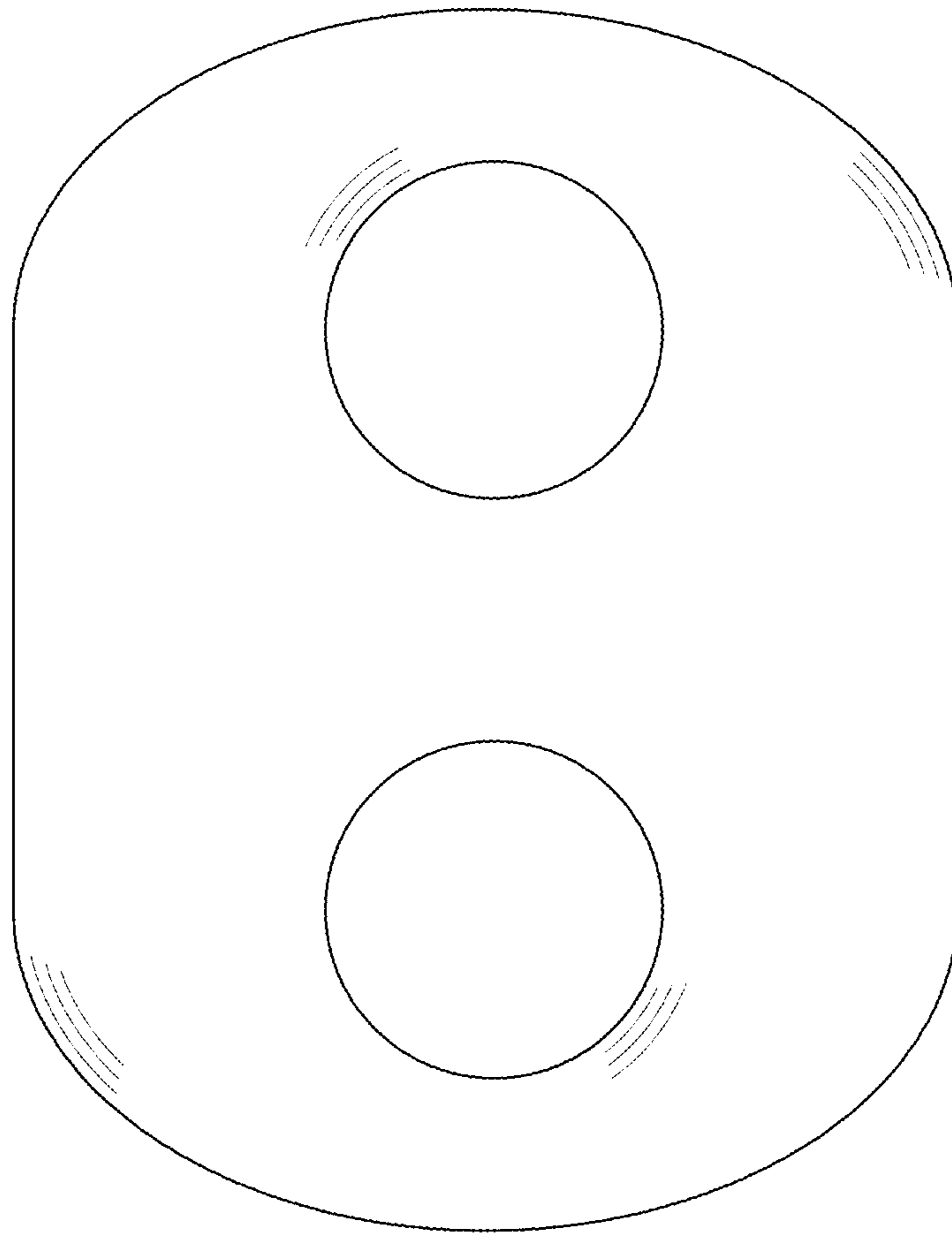

FIG. 10



FIG.11



FIG.12



FIG. 13



FIG.14

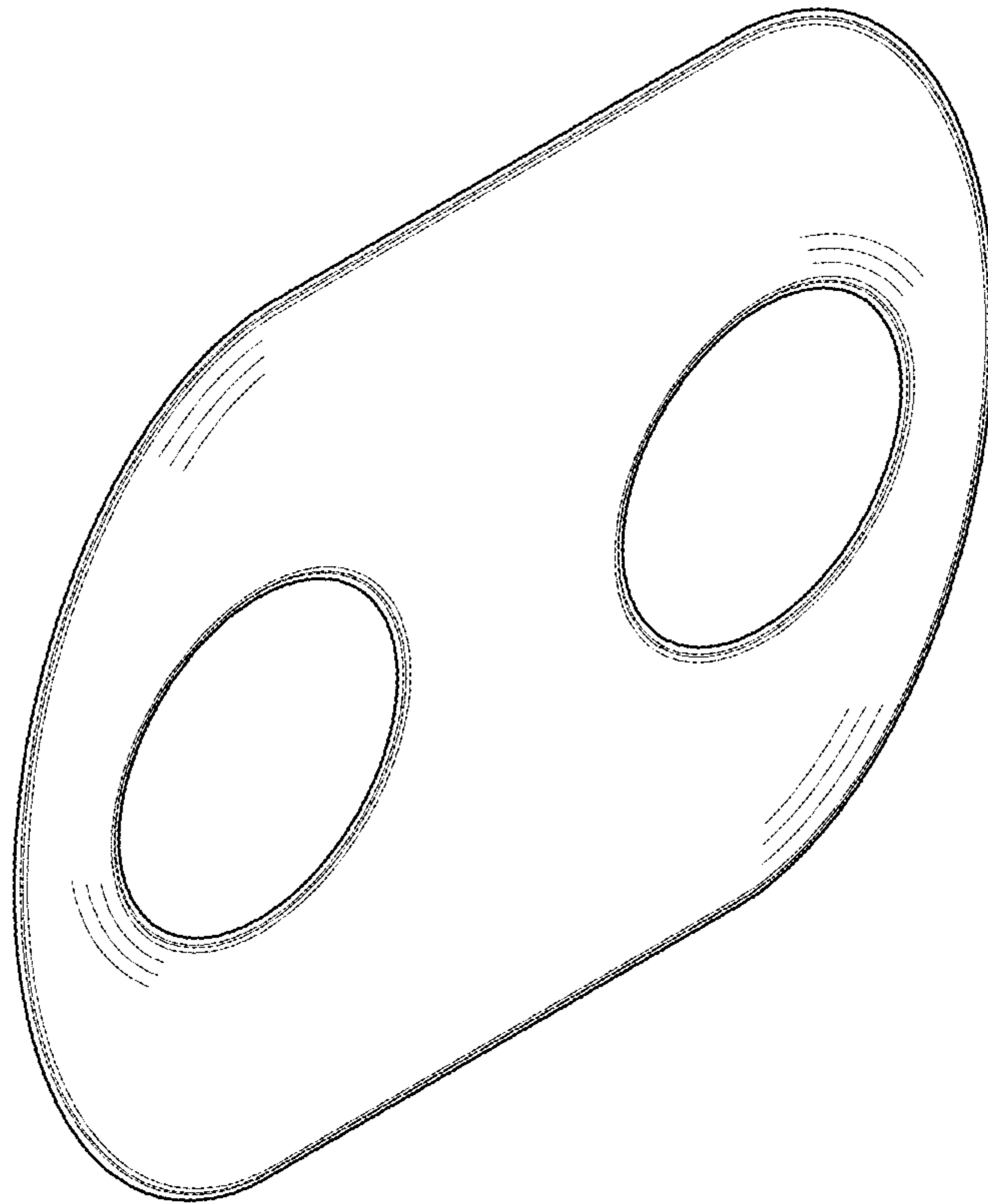

FIG.15

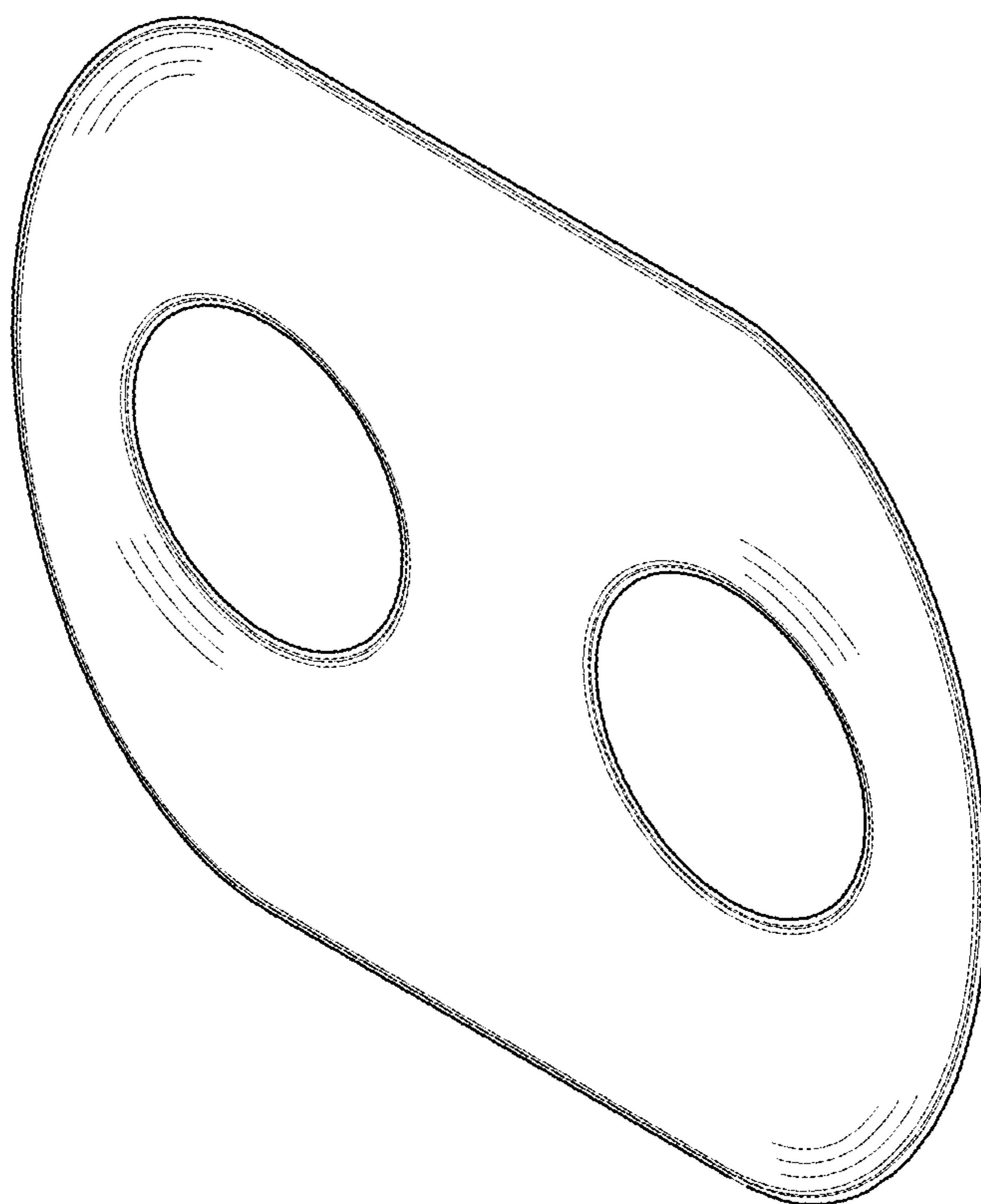

FIG. 16

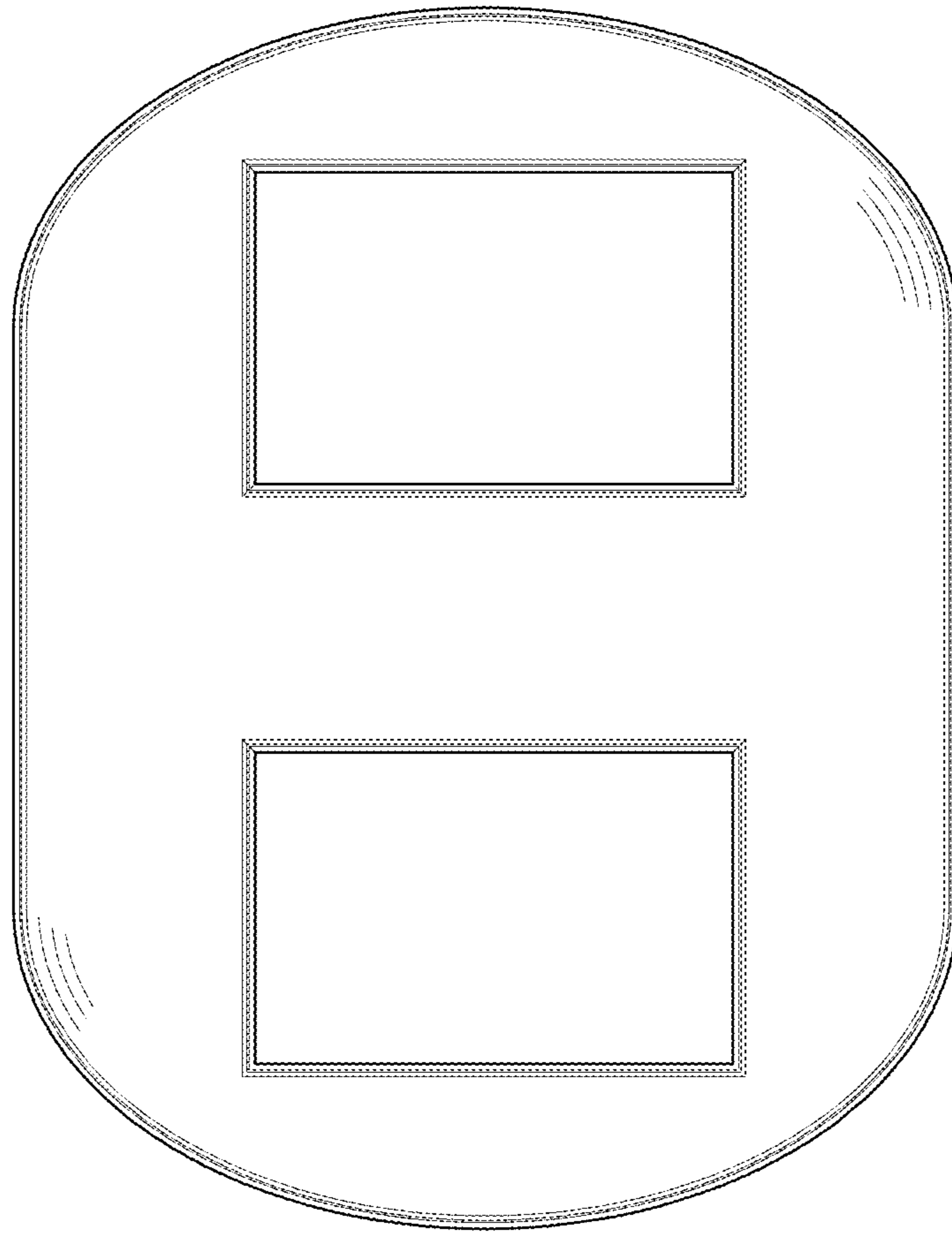

FIG. 17

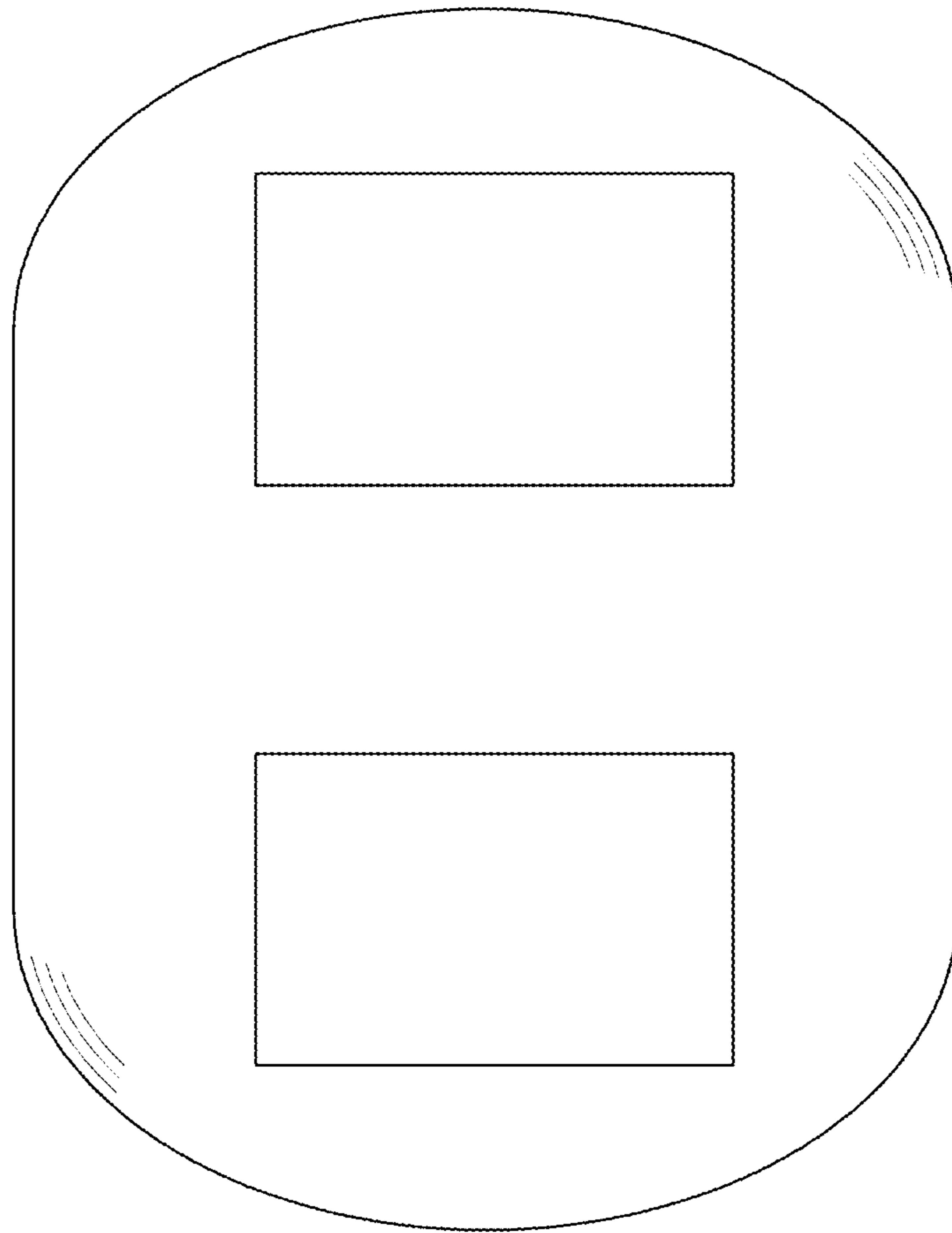

FIG. 18

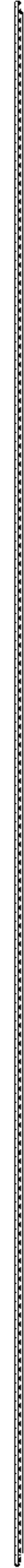

FIG.19



FIG.20



FIG.21

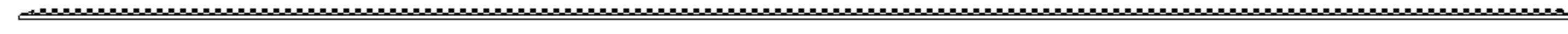

FIG.22

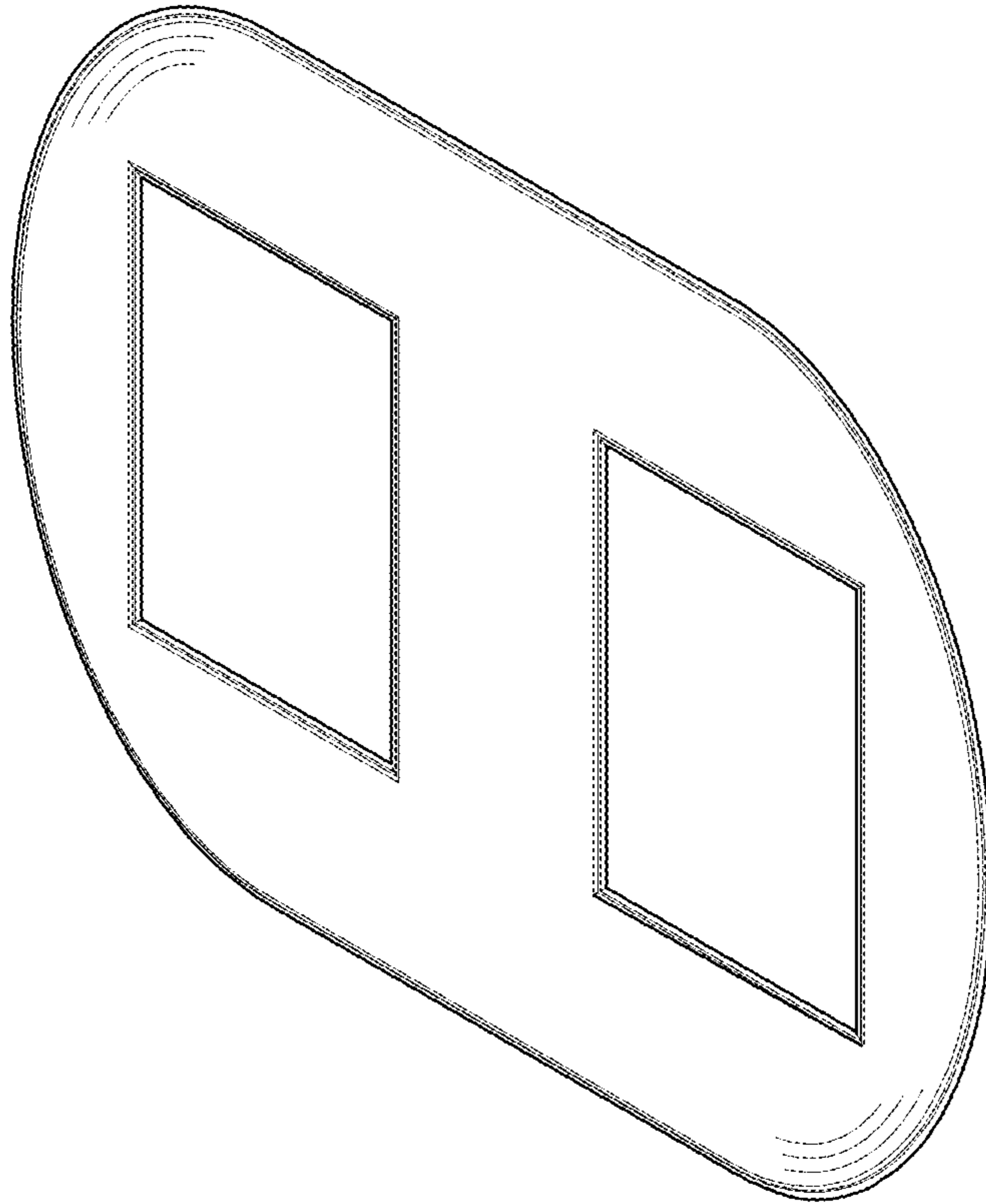

FIG.23

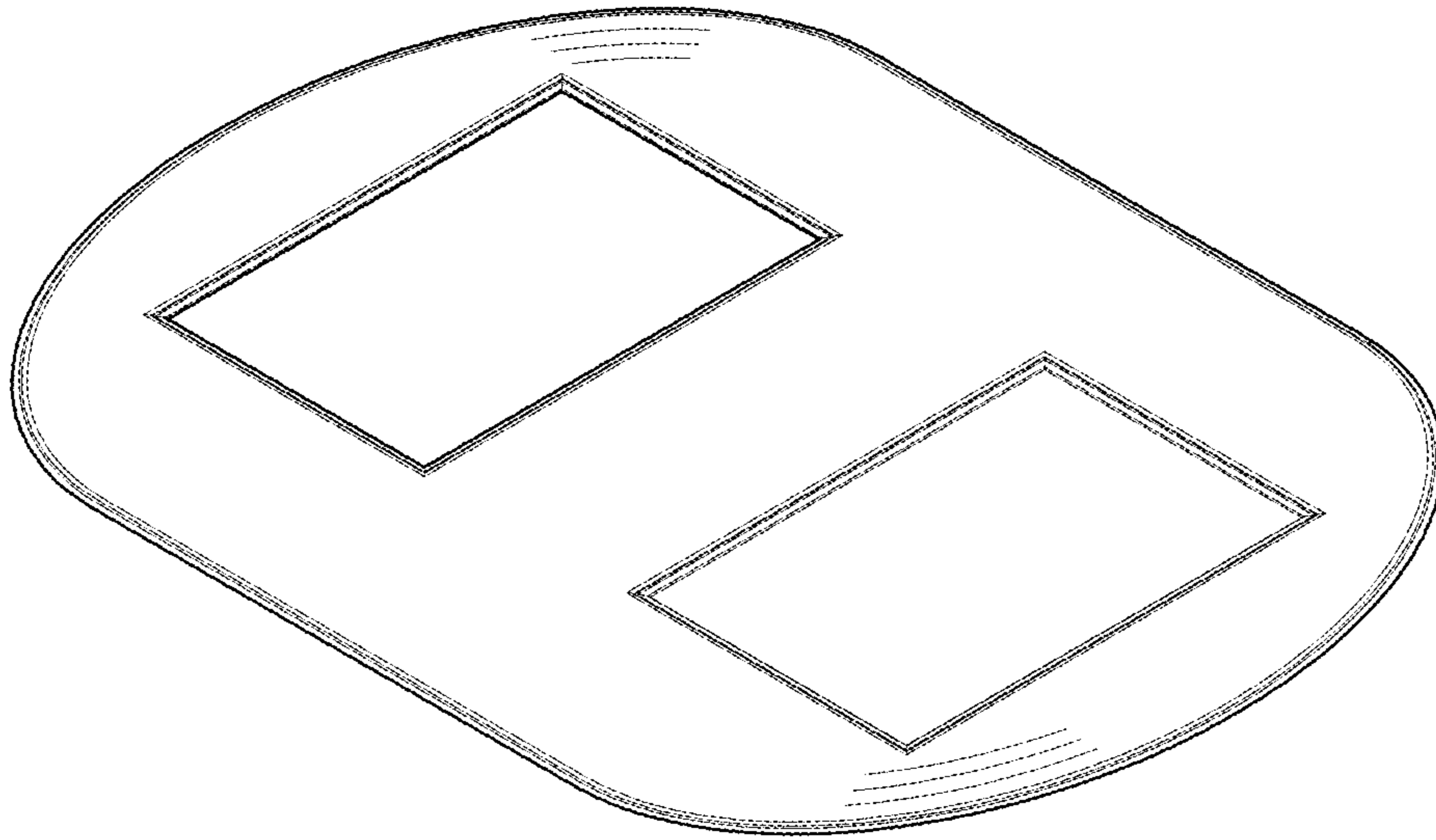

FIG.24

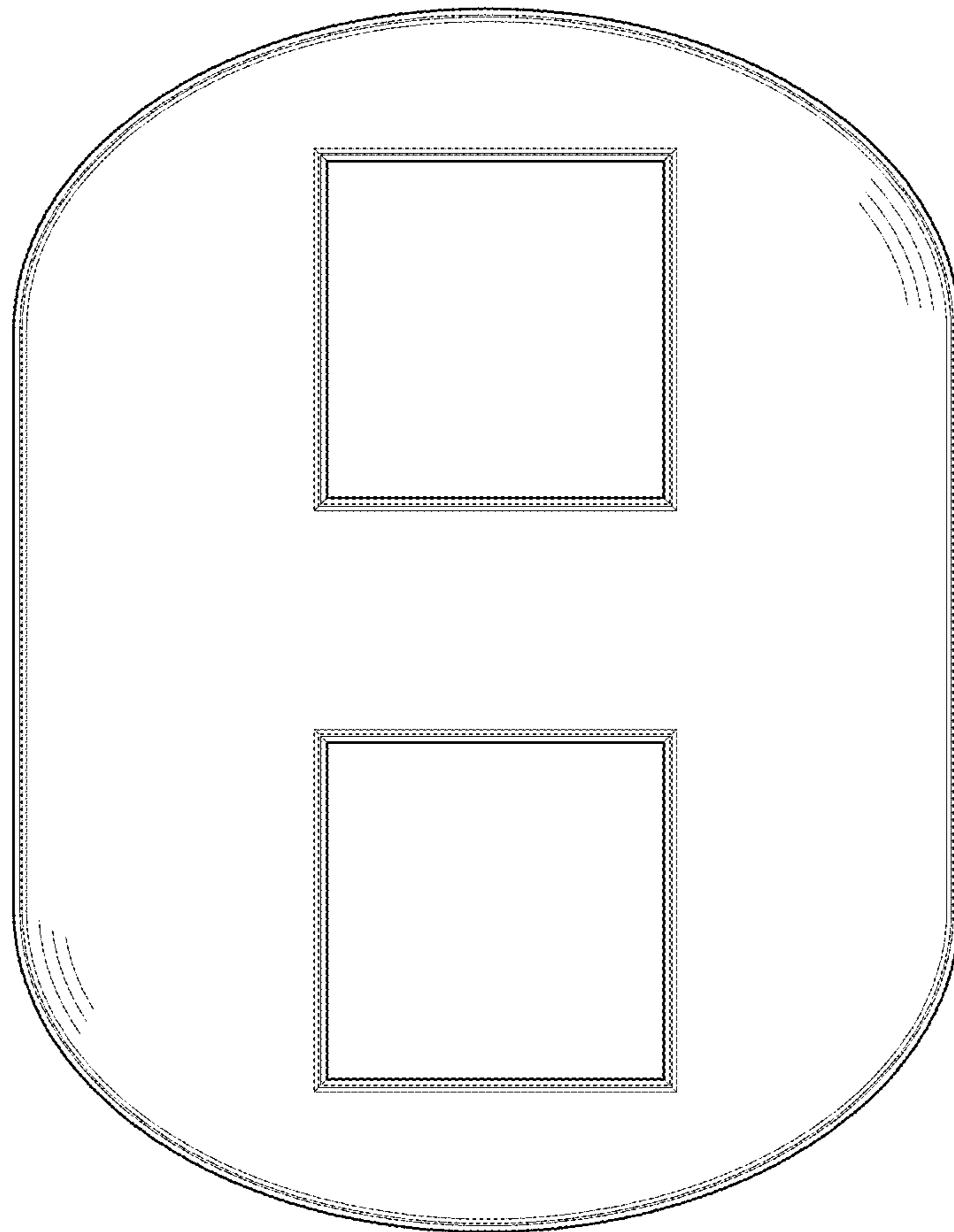

FIG.25

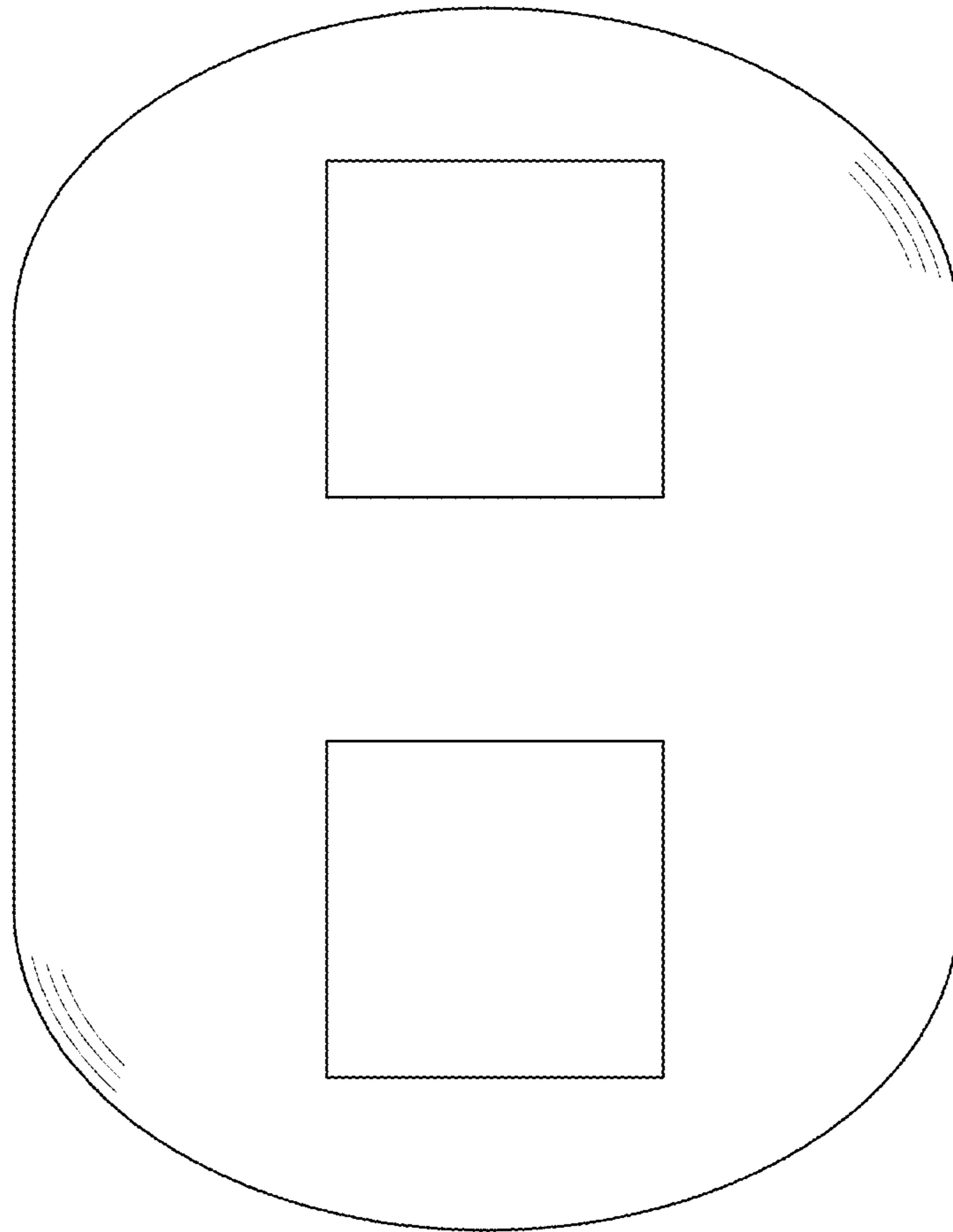

FIG. 26



FIG.27

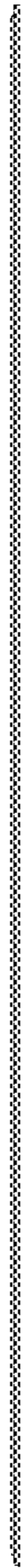

FIG.28



FIG.29



FIG.30

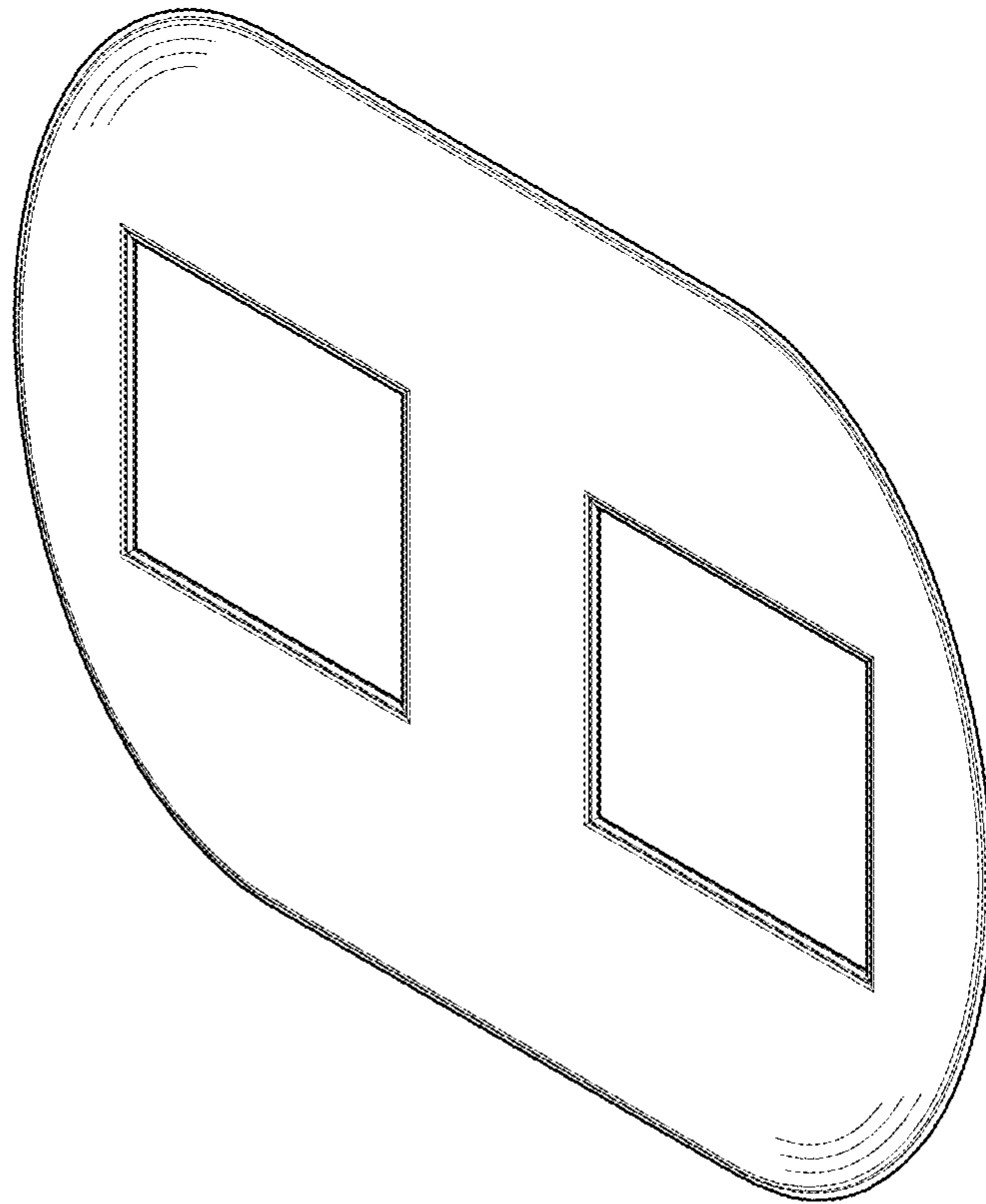

FIG.31

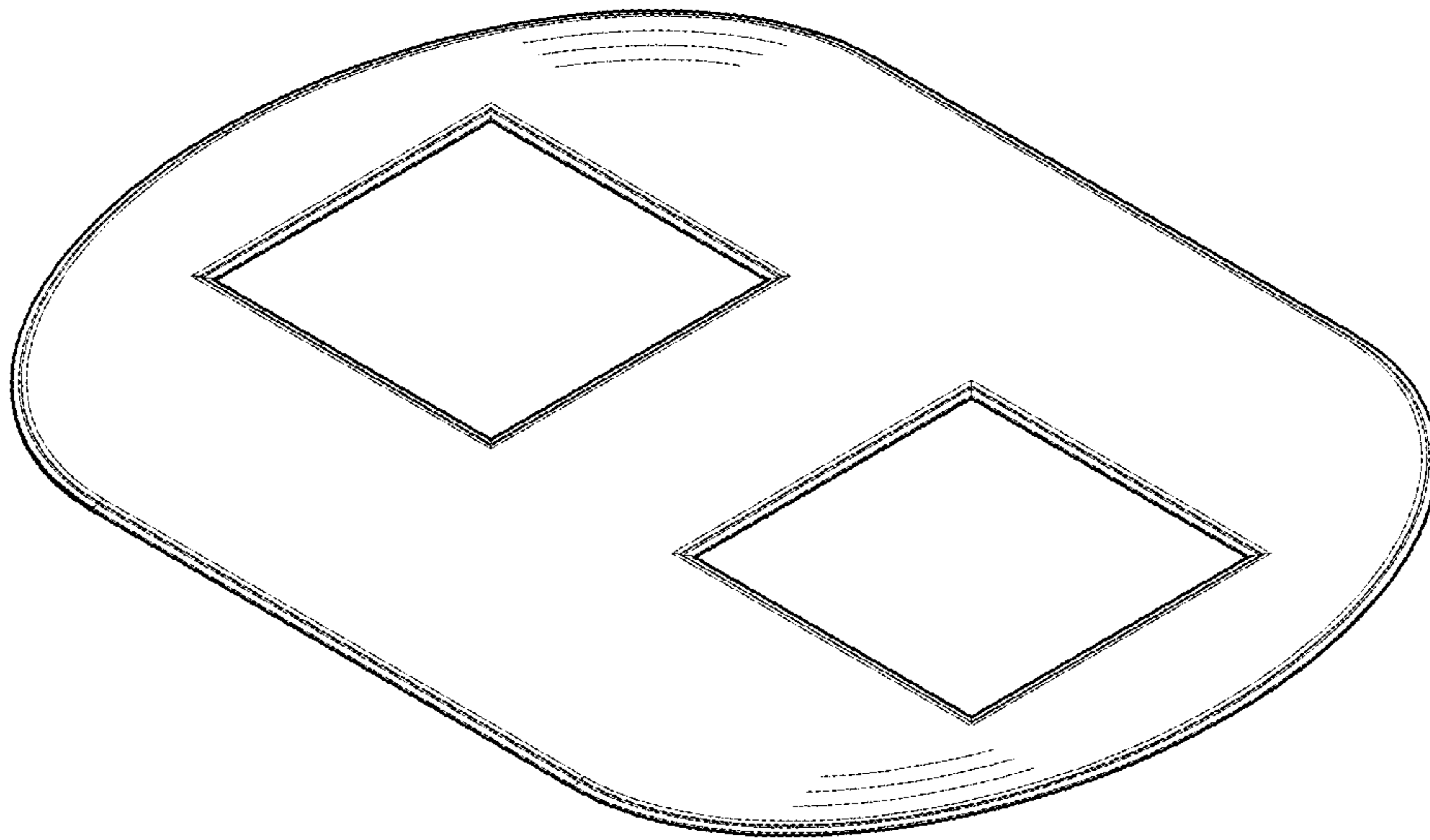

FIG.32

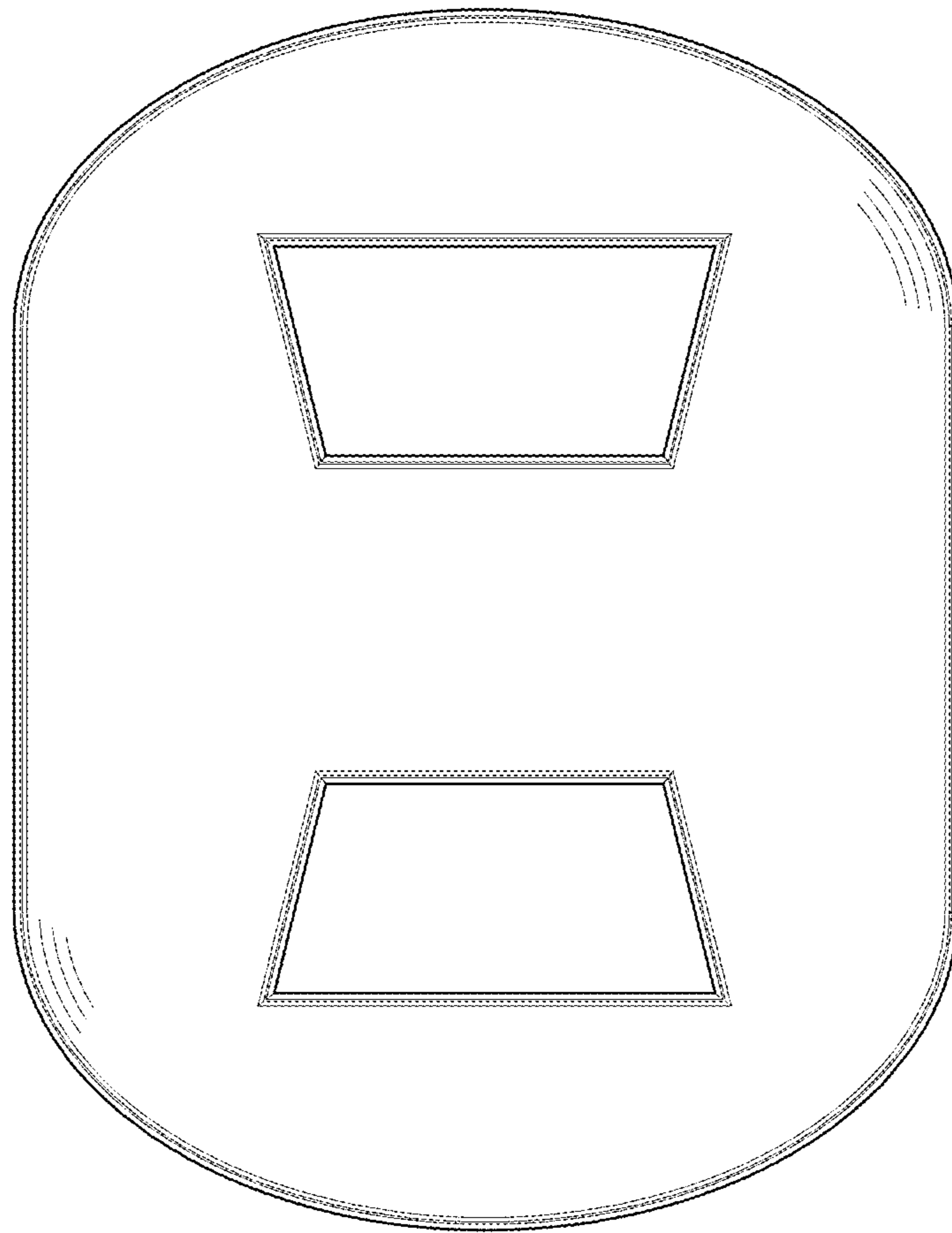

FIG.33

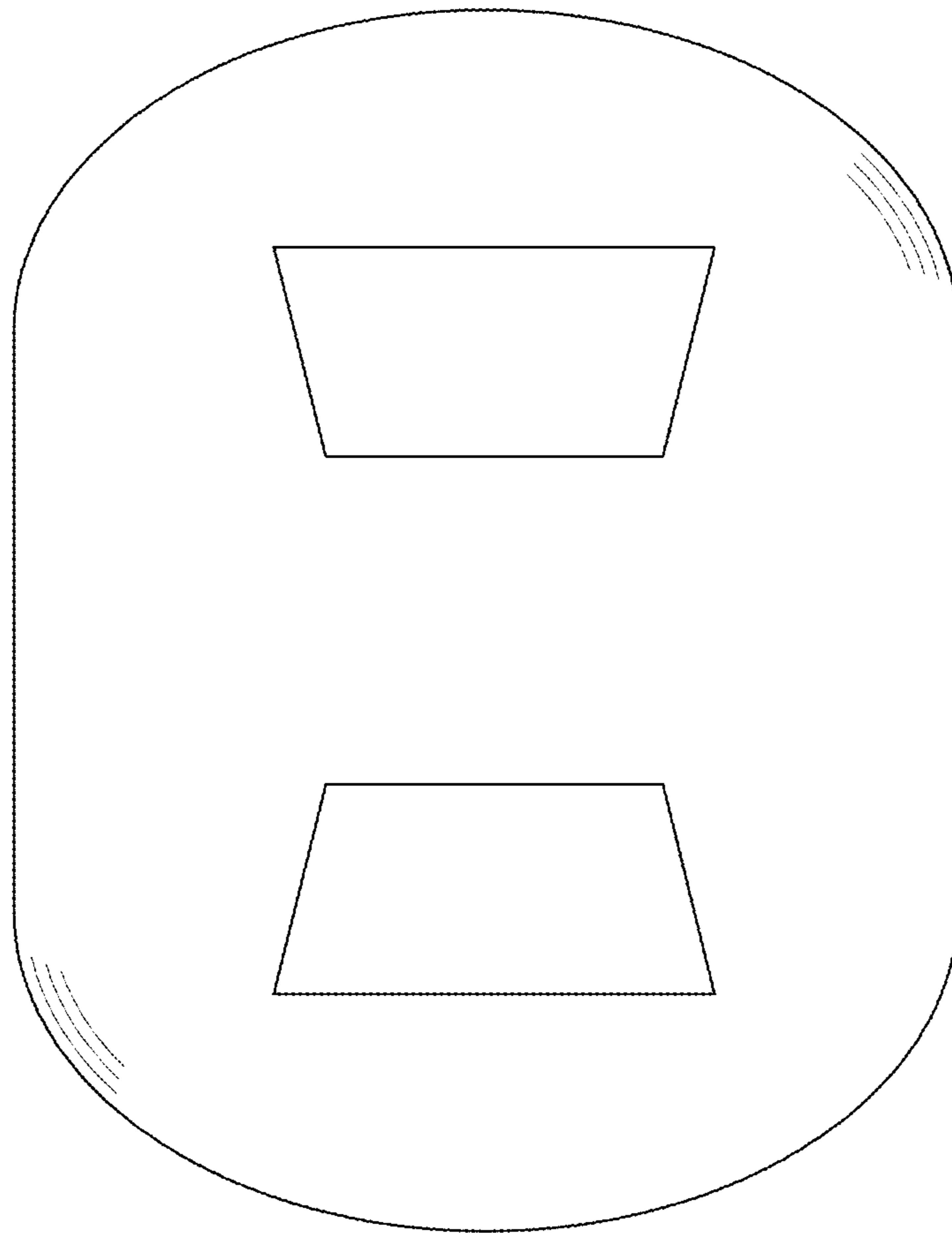

FIG.34



FIG.35

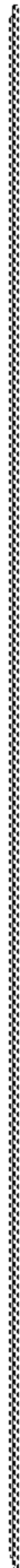

FIG.36



FIG.37

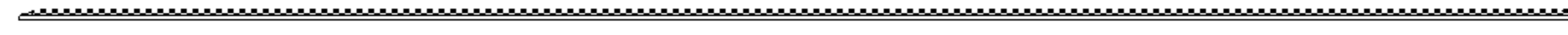

FIG.38

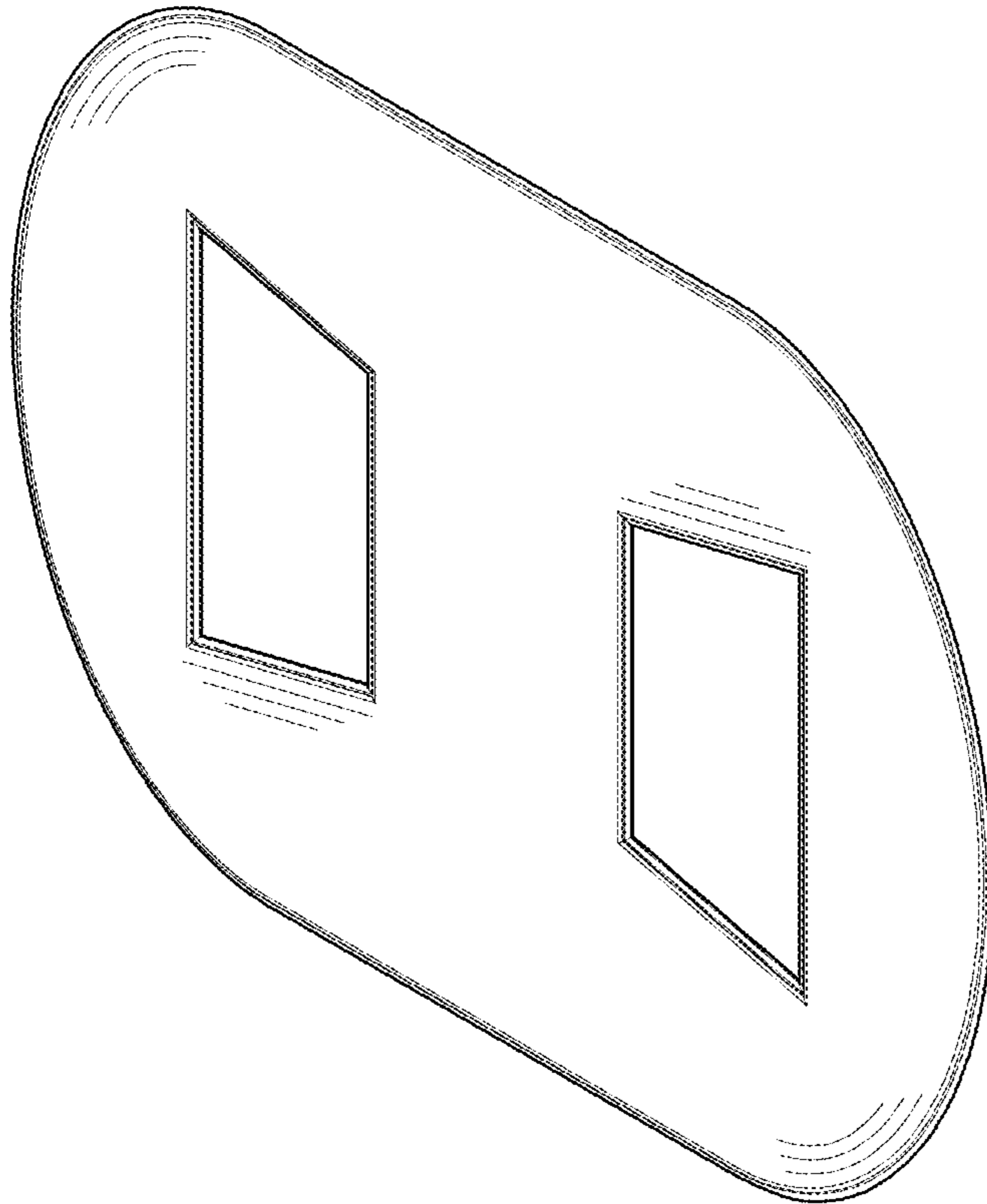

FIG.39

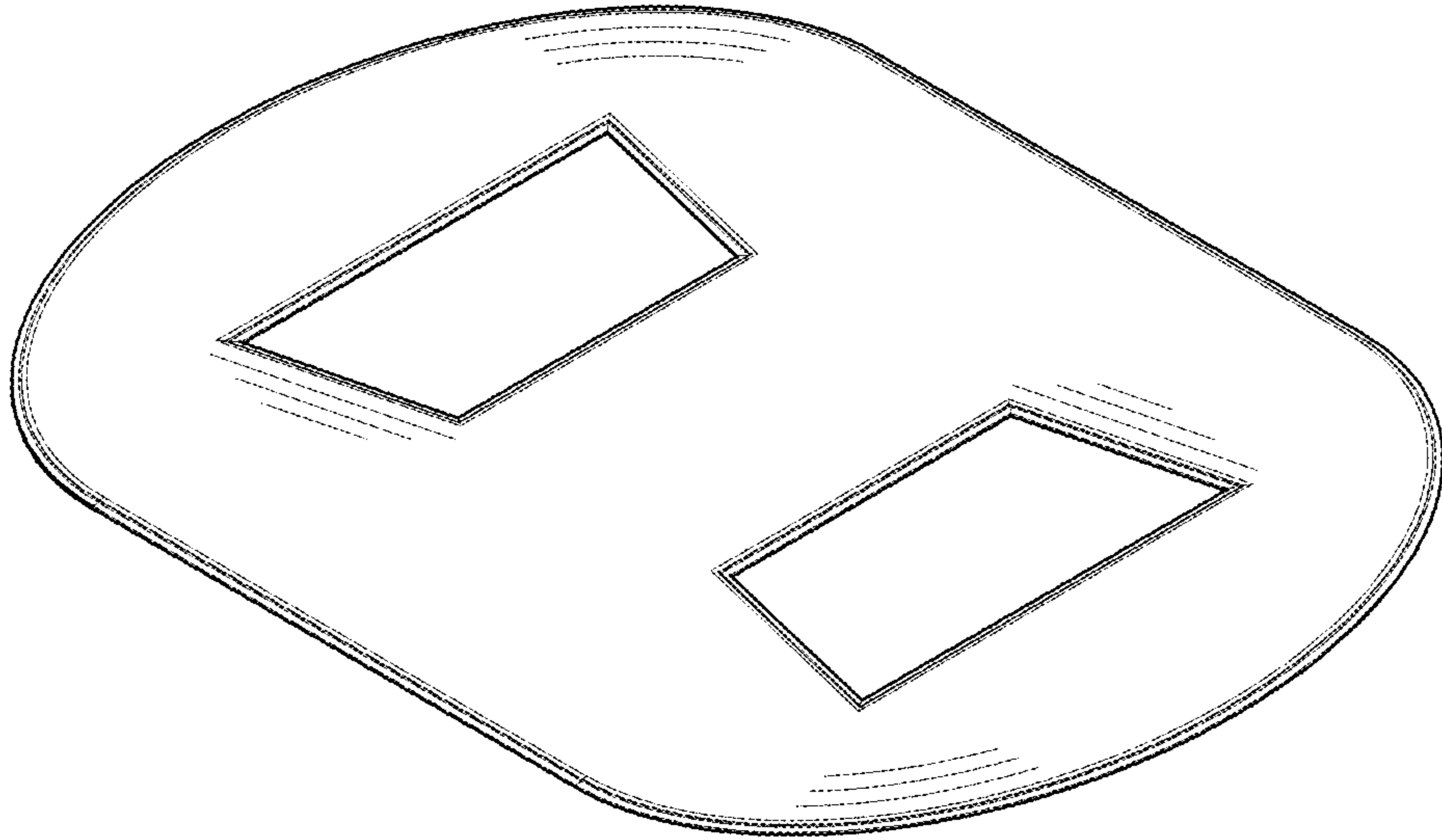

FIG.40