



US00D956724S

(12) **United States Design Patent**
Yang

(10) **Patent No.:** **US D956,724 S**
(45) **Date of Patent:** **** Jul. 5, 2022**

(54) **ANTENNA**

(71) Applicant: **Shenzhen Antop Technology Co. Ltd.**,
Guangdong (CN)

(72) Inventor: **Ruidian Yang**, Guangdong (CN)

(**) Term: **15 Years**

(21) Appl. No.: **29/718,979**

(22) Filed: **Dec. 31, 2019**

(30) **Foreign Application Priority Data**

Oct. 12, 2019 (CN) 201930556568.5

(51) **LOC (13) Cl.** **14-03**

(52) **U.S. Cl.**
USPC **D14/230**

(58) **Field of Classification Search**
USPC D14/230, 218; D21/658, 659, 712, 301,
D21/455, 436, 812, 781, 706, 478, 505;
D30/160

(Continued)

(56) **References Cited**

U.S. PATENT DOCUMENTS

D170,203 S * 8/1953 Leonard D14/230
3,434,145 A * 3/1969 Wells H01Q 9/265
343/726

(Continued)

FOREIGN PATENT DOCUMENTS

CN 304723184 * 7/2018
CN 305240692 * 7/2019

(Continued)

OTHER PUBLICATIONS

UltraPro Store, Quadcore Outdoor TV Antenna . . . , available at
amazon.com, date first available Mar. 26, 2021, site visited Mar. 7,

2022, Available at URL: <https://www.amazon.com/GE-Quadcore-Supports-Weatherproof-48896/dp/B0917565C8?th=1> (Year: 2021).*

Primary Examiner — Daniel J Domino
Assistant Examiner — Samina Vieth

(74) *Attorney, Agent, or Firm* — Prakash Nama; Global
IP Services, PLLC

(57) **CLAIM**

The ornamental design for an antenna, as shown and
described.

DESCRIPTION

FIG. 1 is a front view of a first embodiment of an antenna
showing my new design;
FIG. 2 is a rear view thereof;
FIG. 3 is a left side view thereof;
FIG. 4 is a right side view thereof;
FIG. 5 is a top plan view thereof;
FIG. 6 is a bottom plan view thereof;
FIG. 7 is a perspective view thereof;
FIG. 8 is another perspective view thereof;
FIG. 9 is a front view of a second embodiment of an antenna
showing my new design;
FIG. 10 is a rear view thereof;
FIG. 11 is a left side view thereof;
FIG. 12 is a right side view thereof;
FIG. 13 is a top plan view thereof;
FIG. 14 is a bottom plan view thereof;
FIG. 15 is a perspective view thereof;
FIG. 16 is another perspective view thereof;
FIG. 17 is a front view of a third embodiment of an antenna
showing my new design;
FIG. 18 is a rear view thereof;
FIG. 19 is a left side view thereof;
FIG. 20 is a right side view thereof;
FIG. 21 is a top plan view thereof;
FIG. 22 is a bottom plan view thereof;
FIG. 23 is a perspective view thereof;
FIG. 24 is another perspective view thereof;
FIG. 25 is a front view of a fourth embodiment of an antenna
showing my new design;
FIG. 26 is a rear view thereof;

(Continued)

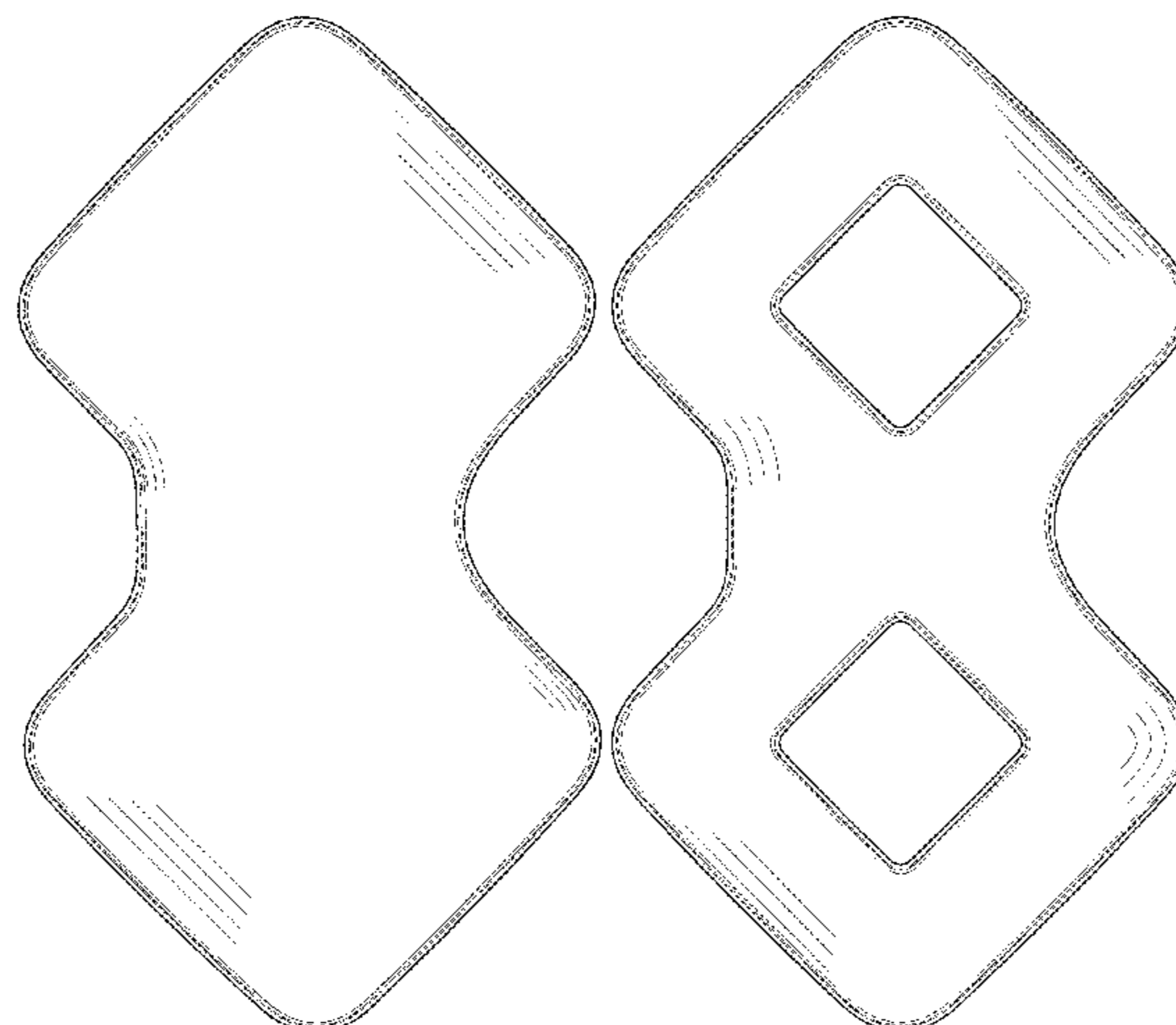

FIG. 27 is a left side view thereof;
 FIG. 28 is a right side view thereof;
 FIG. 29 is a top plan view thereof;
 FIG. 30 is a bottom plan view thereof;
 FIG. 31 is a perspective view thereof; and,
 FIG. 32 is another perspective view thereof.

1 Claim, 32 Drawing Sheets

(58) **Field of Classification Search**

CPC B60R 13/005; H01Q 9/28; H01Q 7/00;
 H01Q 19/138; H01Q 19/106; H01Q
 19/005

See application file for complete search history.

(56) **References Cited**

U.S. PATENT DOCUMENTS

D546,649 S * 7/2007 Jennings D8/21
 D598,434 S * 8/2009 Schneider D14/230
 D628,218 S * 11/2010 Tommassini D15/138
 8,599,079 B2 * 12/2013 Kudo H01Q 1/3291
 343/773
 D699,228 S * 2/2014 Ferguson D14/230
 D709,865 S * 7/2014 Ferguson D14/230
 D709,866 S * 7/2014 Ferguson D14/230
 D771,348 S * 11/2016 Traynor D1/128
 D798,132 S * 9/2017 Meyers D8/374
 D804,459 S * 12/2017 Feit D14/230
 D809,490 S * 2/2018 Feit D14/230
 D821,990 S * 7/2018 Sung D13/199
 D821,991 S * 7/2018 Sung D13/199
 D821,994 S * 7/2018 Sung D13/199
 D831,010 S * 10/2018 Yang D14/230
 D831,622 S * 10/2018 Yang D14/230
 D833,839 S * 11/2018 Scano D8/21
 D834,781 S * 12/2018 Traynor D1/120

D837,188 S * 1/2019 Yang D14/230
 D837,769 S * 1/2019 Yang D14/230
 D838,697 S * 1/2019 Yang D14/230
 D838,703 S * 1/2019 Yang D14/230
 D843,983 S * 3/2019 Yang D14/230
 D847,798 S * 5/2019 Yang D14/230
 D849,722 S * 5/2019 Yang D14/230
 D852,172 S * 6/2019 Wu D14/230
 D857,672 S * 8/2019 Zhao D14/230
 D867,347 S * 11/2019 Ross, III D14/230
 D872,714 S * 1/2020 Yang D14/230
 D881,172 S * 4/2020 Ross, III D14/230
 D883,264 S * 5/2020 Ross, III D14/230
 D883,265 S * 5/2020 Feit D14/230
 D888,697 S * 6/2020 Ross, III D14/230
 D892,096 S * 8/2020 Feit D14/230
 D896,791 S * 9/2020 Yang D14/230
 D896,792 S * 9/2020 Yang D14/230
 D896,793 S * 9/2020 Yang D14/230
 D896,796 S * 9/2020 Yang D14/230
 D896,797 S * 9/2020 Yang D14/230
 D900,075 S * 10/2020 Yang D14/230
 D901,464 S * 11/2020 Yang D14/230
 D901,465 S * 11/2020 Yang D14/230
 D901,466 S * 11/2020 Yang D14/230
 D902,896 S * 11/2020 Feit D14/230
 D909,350 S * 2/2021 Zhou D14/230
 D918,187 S * 5/2021 Feit D14/230
 D938,944 S * 12/2021 Yang D14/230
 D938,945 S * 12/2021 Yang D14/230
 D939,482 S * 12/2021 Yang D14/230
 D940,695 S * 1/2022 Yang D14/230
 2007/0200769 A1 * 8/2007 Nakano H01Q 1/48
 343/846

FOREIGN PATENT DOCUMENTS

CN 305766716 * 5/2020
 CN 305766719 * 5/2020

* cited by examiner

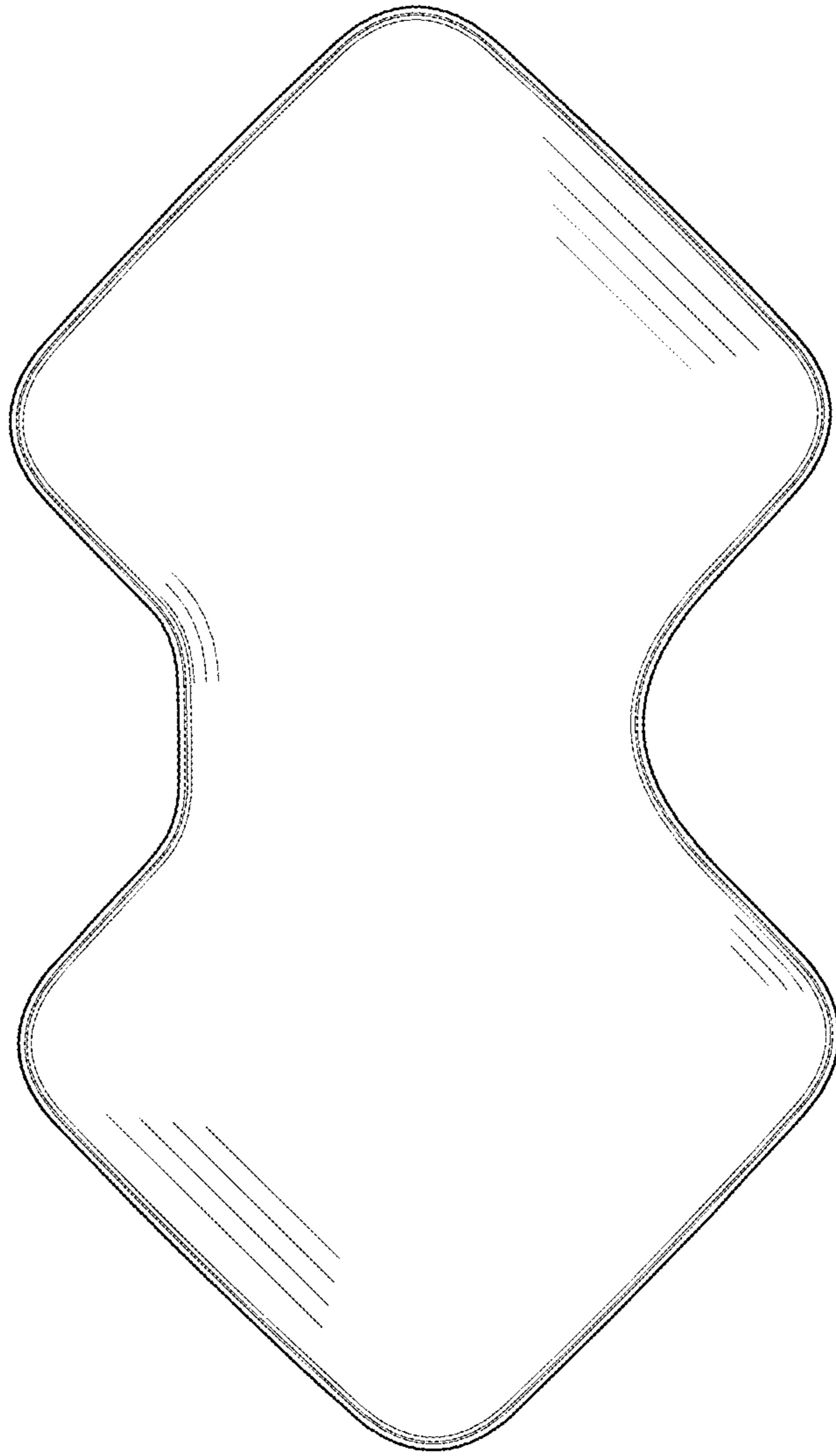

FIG.1

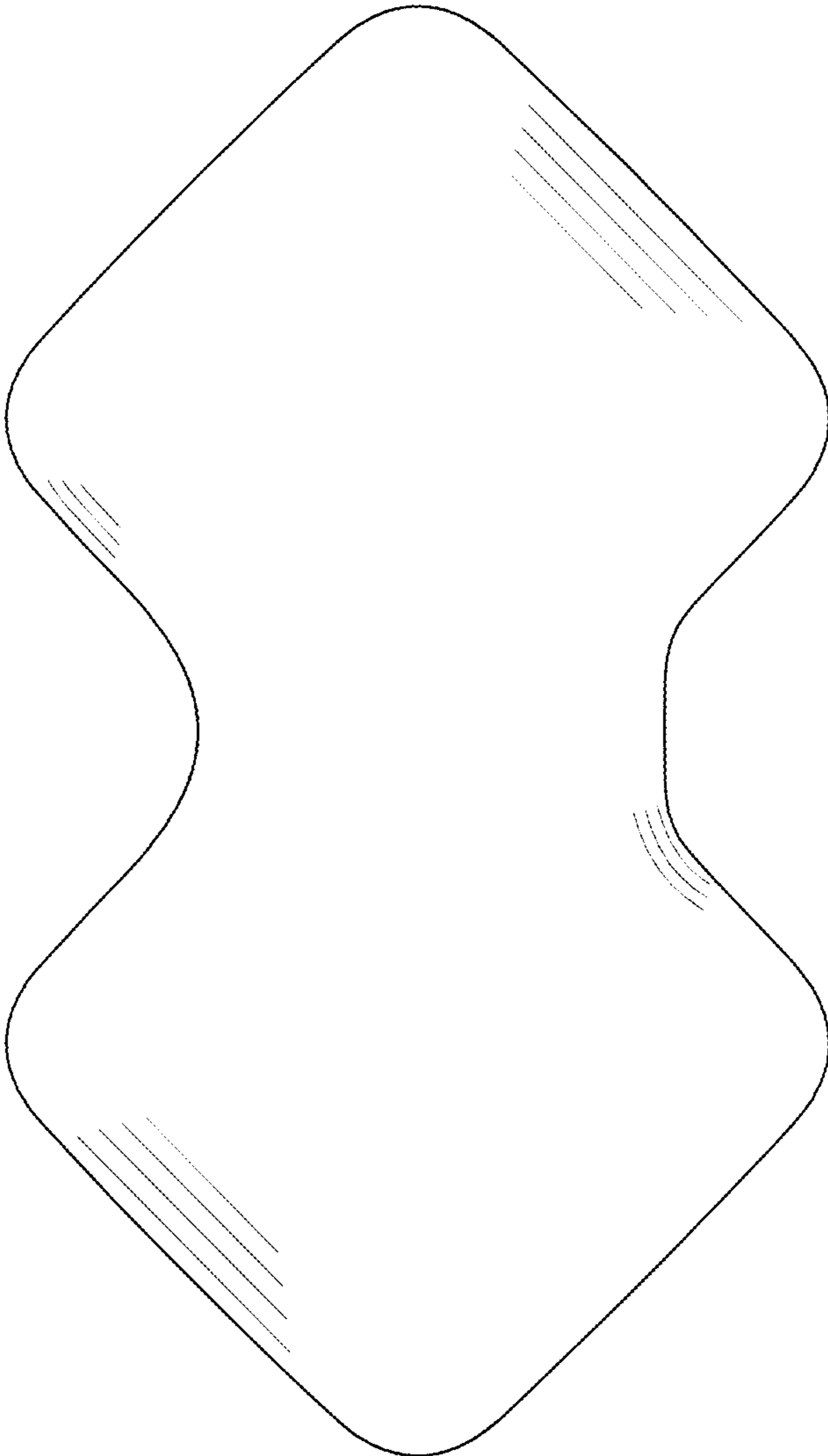

FIG.2



FIG.3



FIG.4



FIG.5

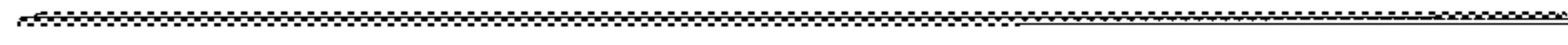

FIG.6

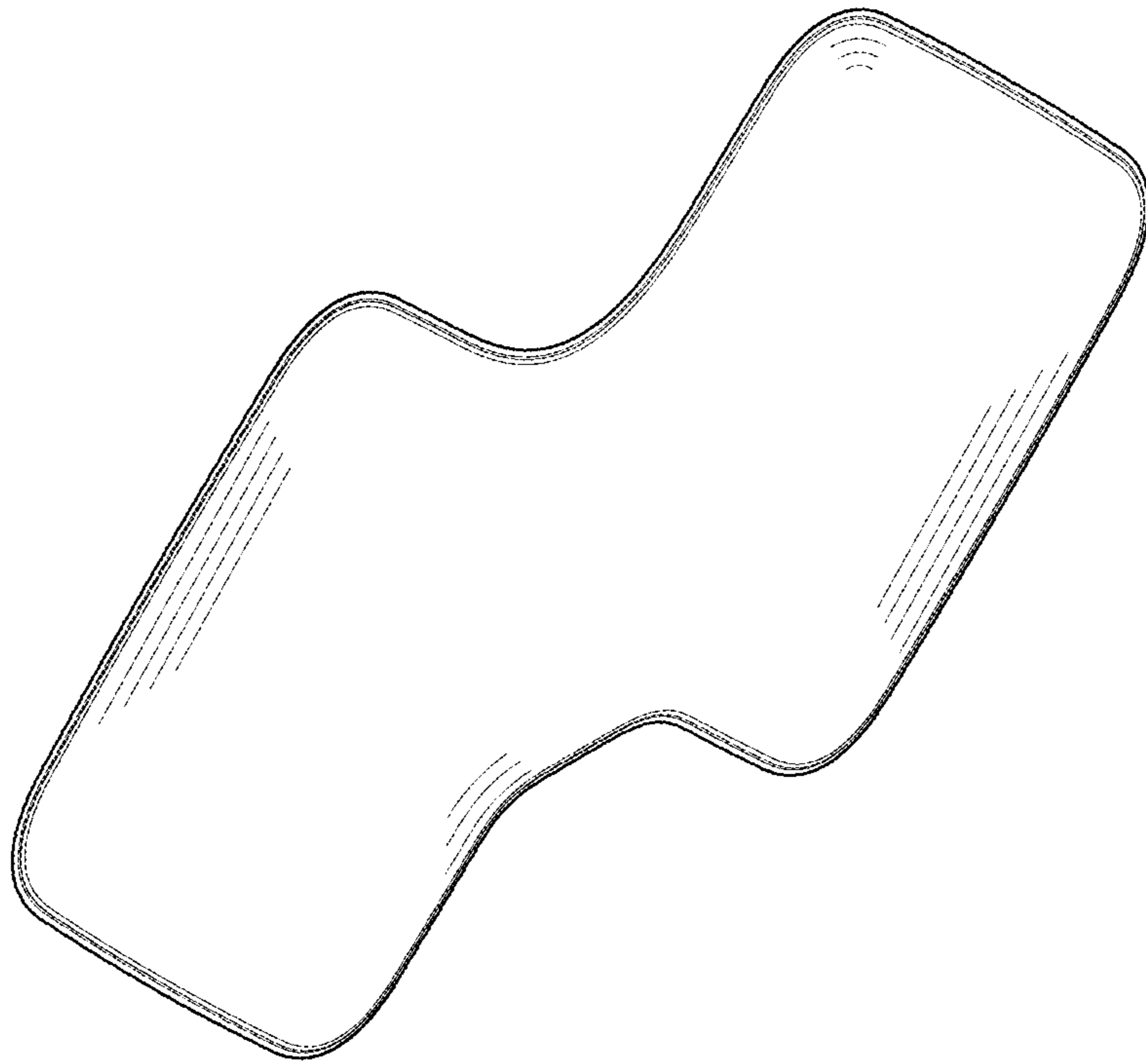

FIG.7

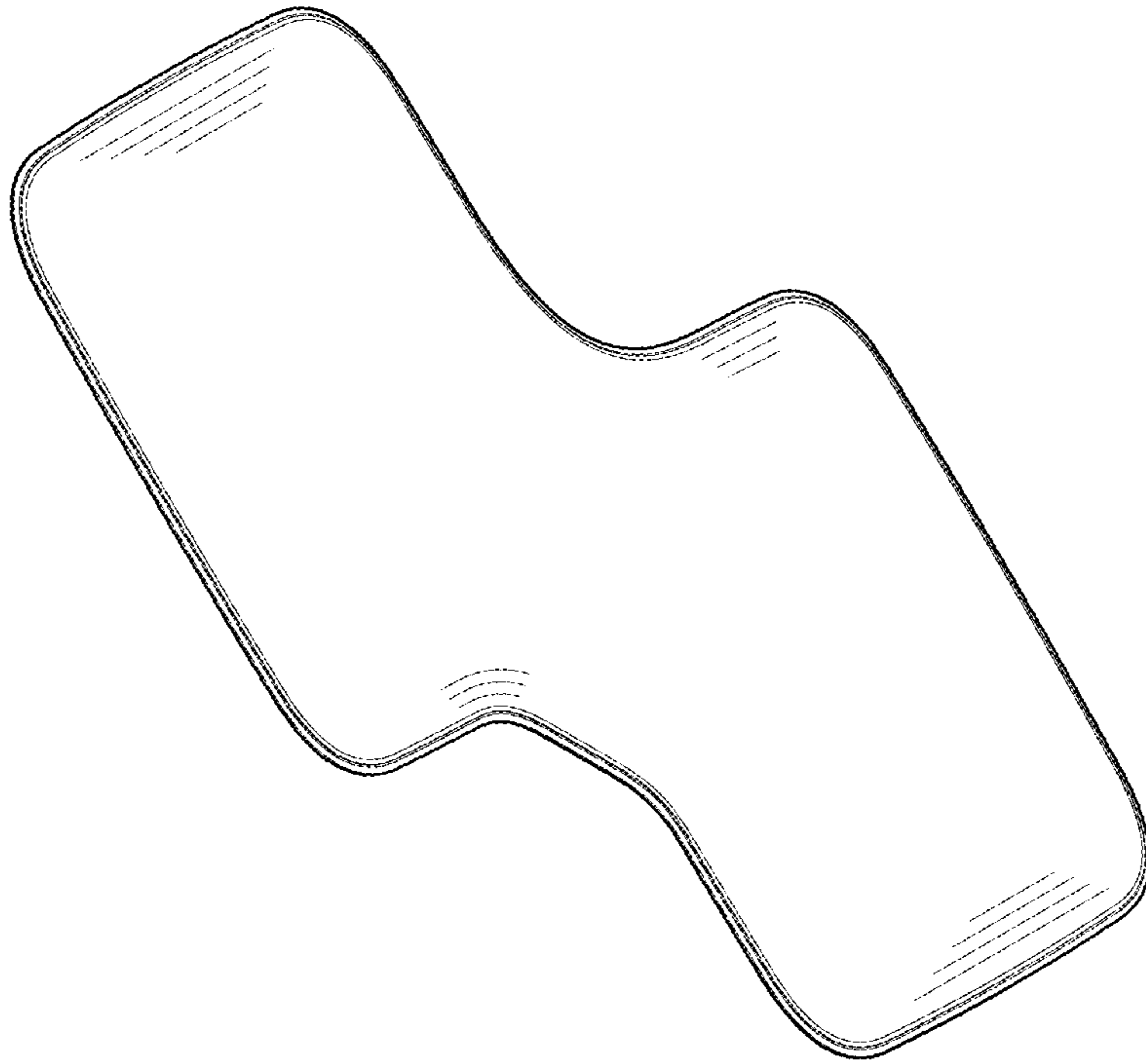

FIG.8

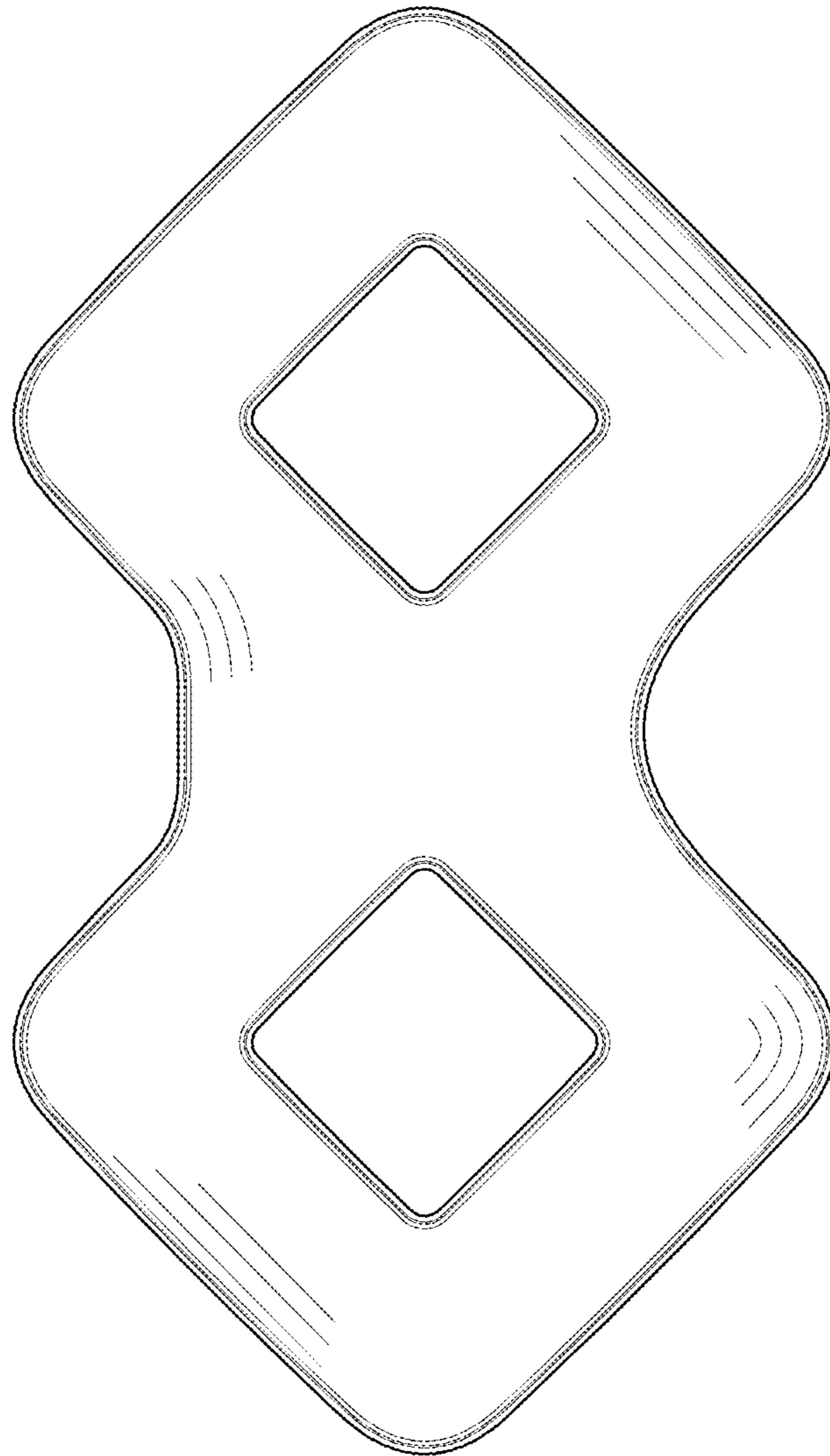

FIG.9

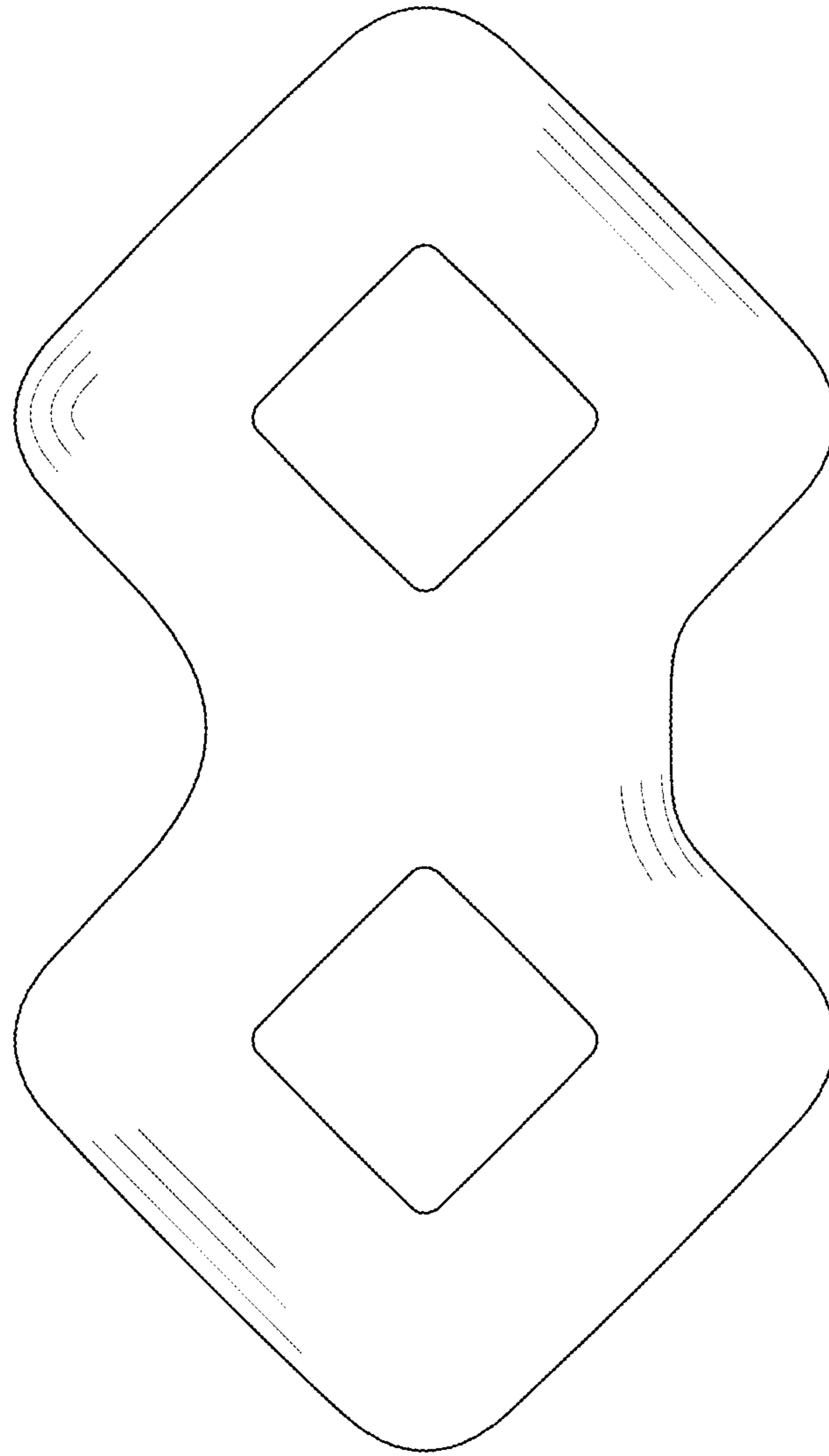

FIG.10

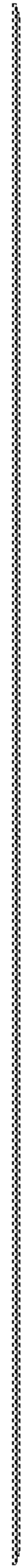

FIG.11

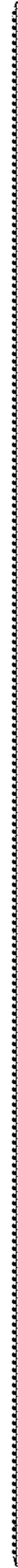

FIG.12



FIG.13

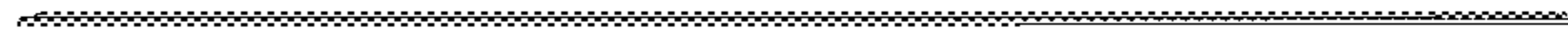

FIG.14

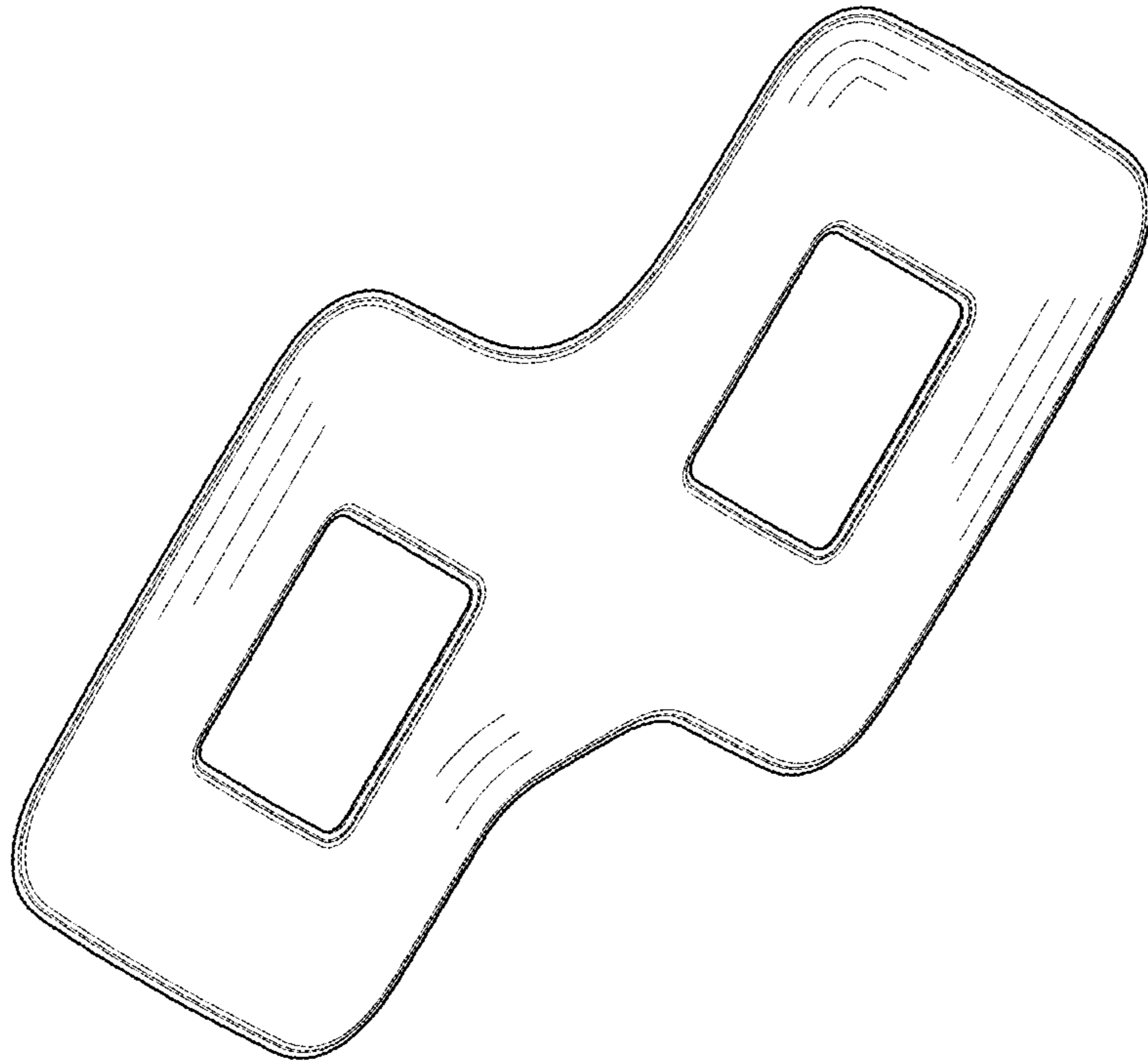

FIG.15

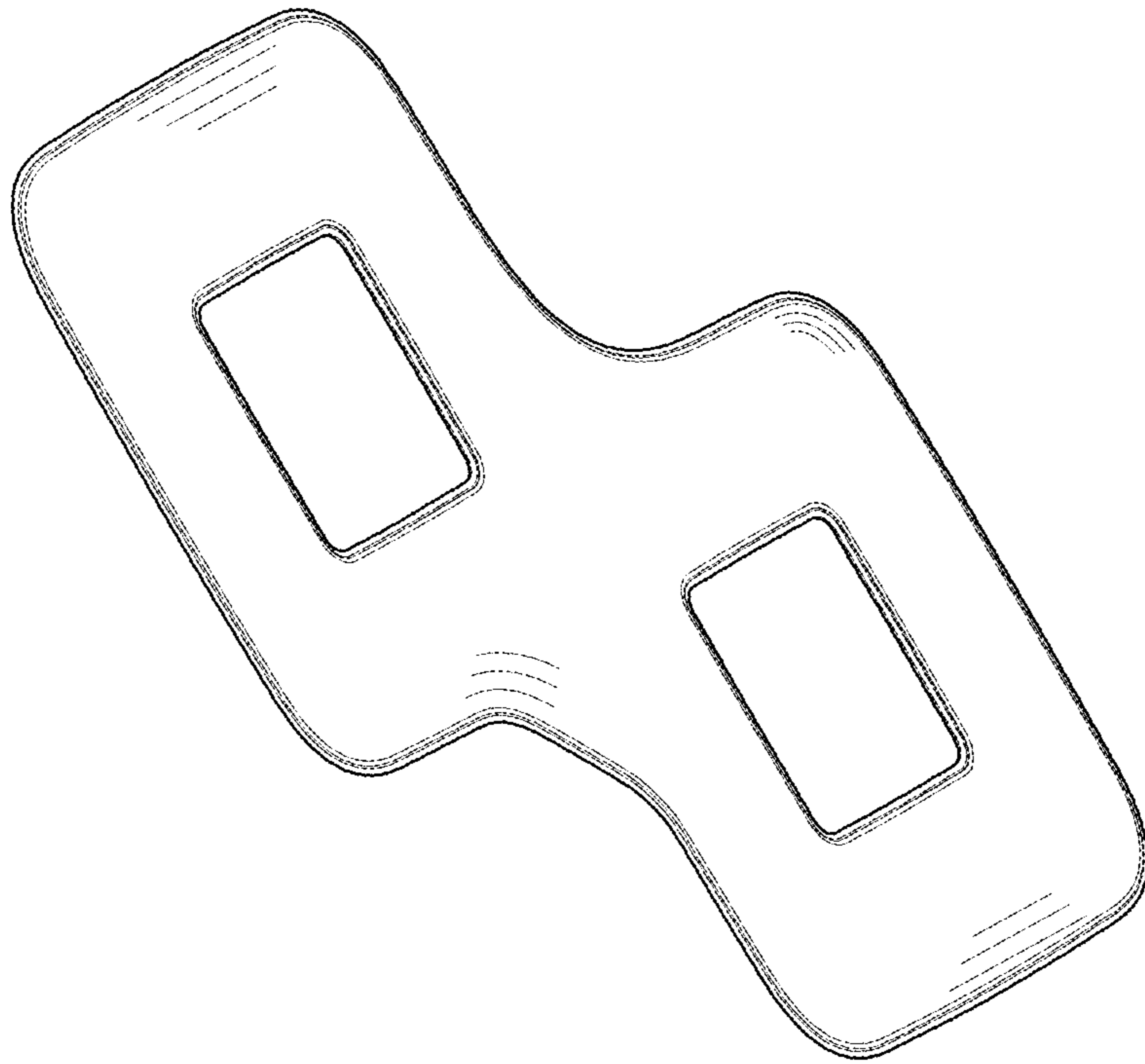

FIG.16

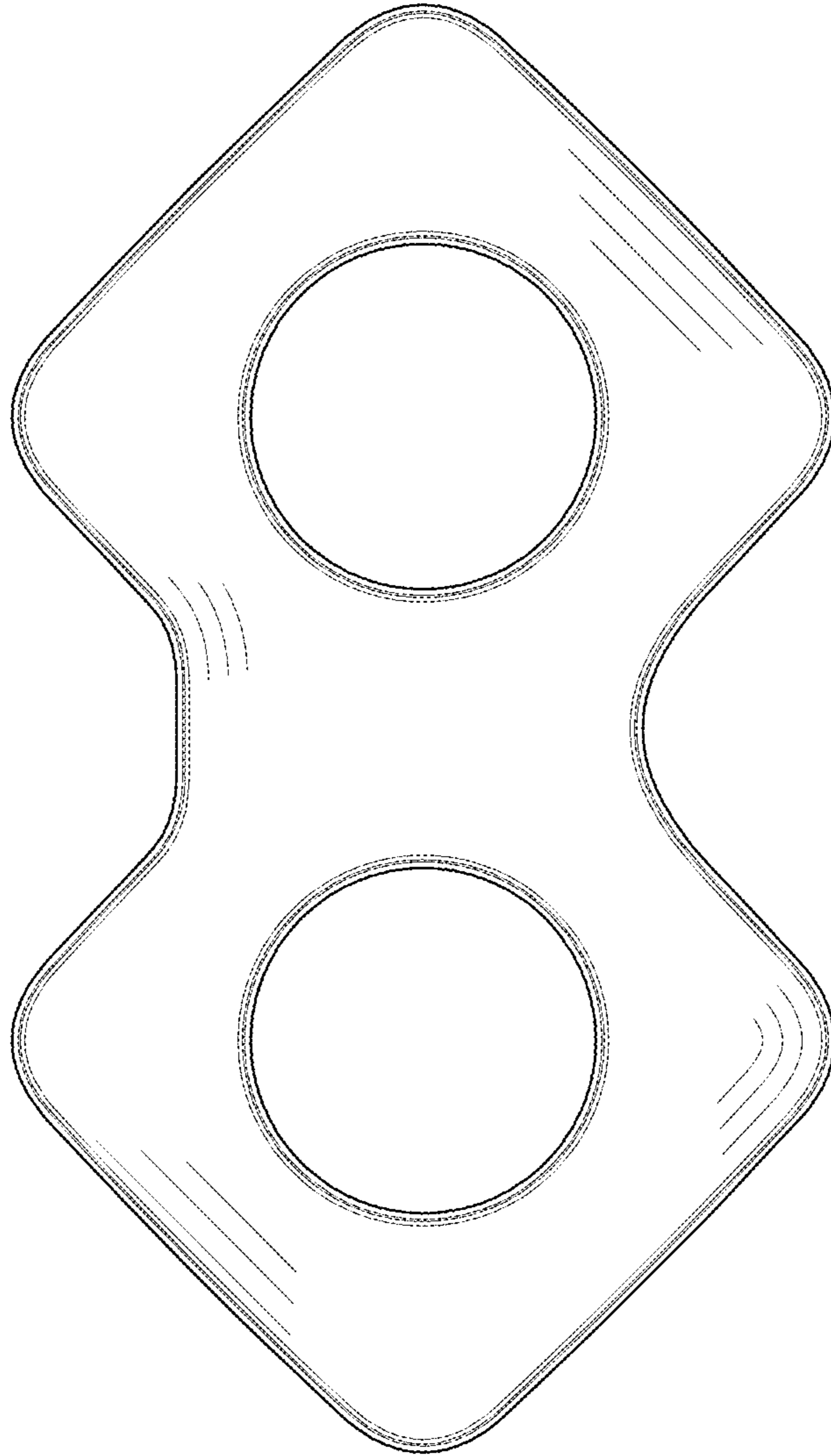

FIG. 17

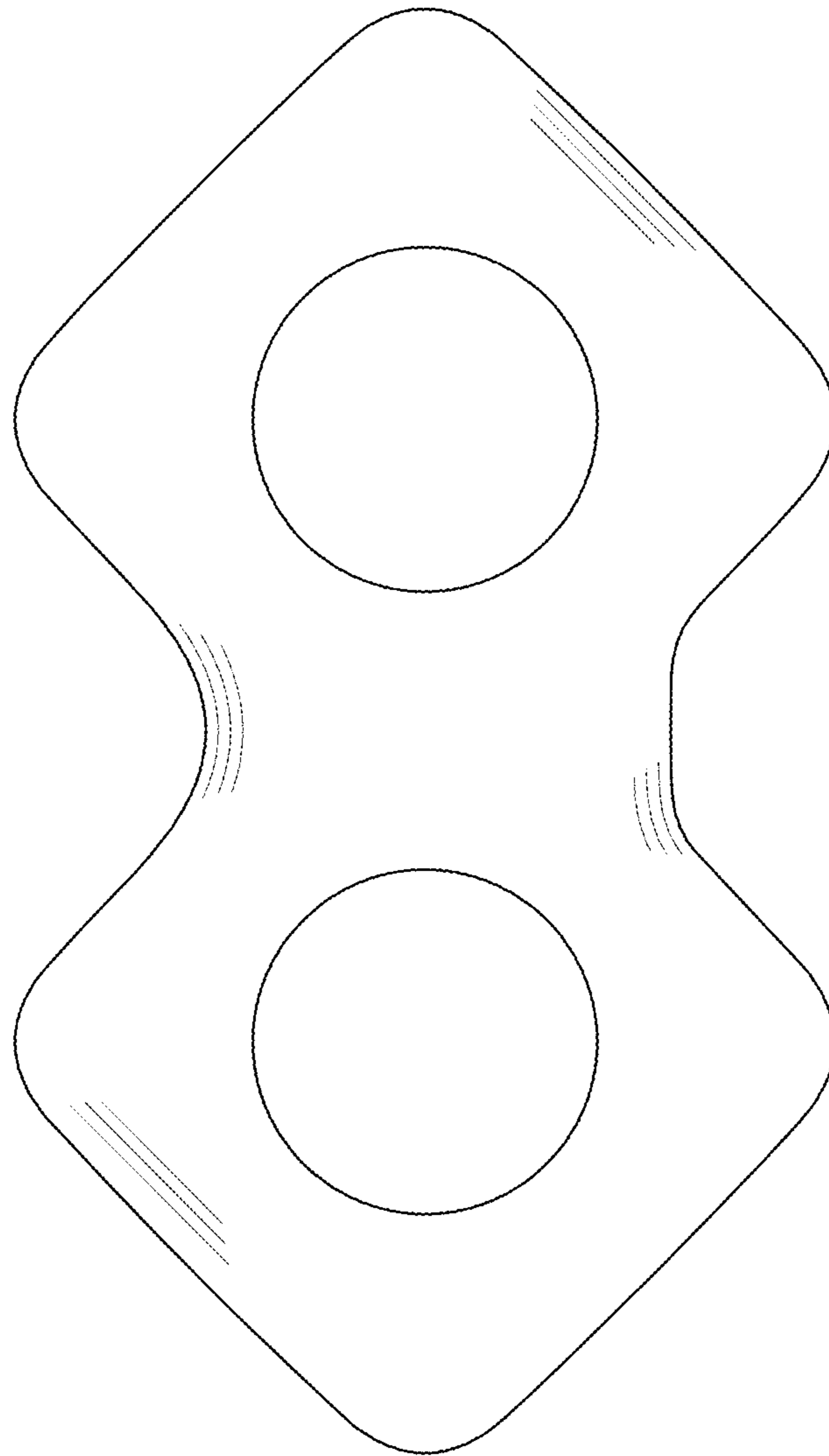

FIG. 18



FIG. 19

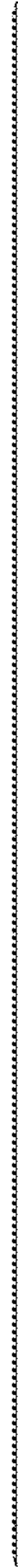

FIG.20



FIG.21

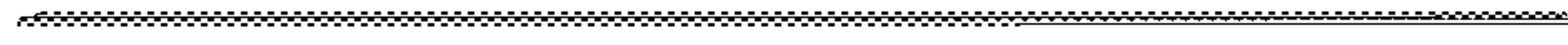

FIG.22

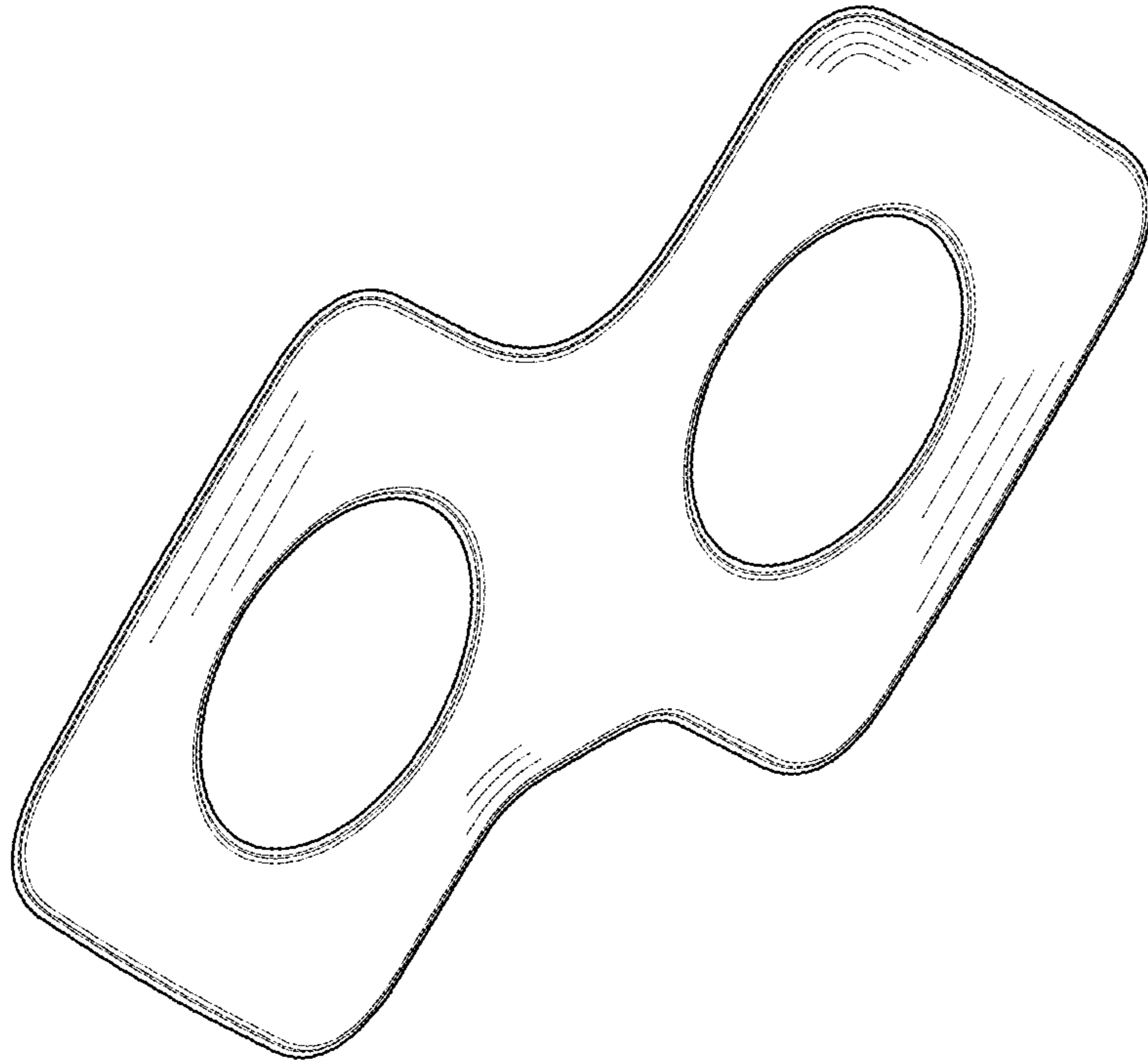

FIG.23

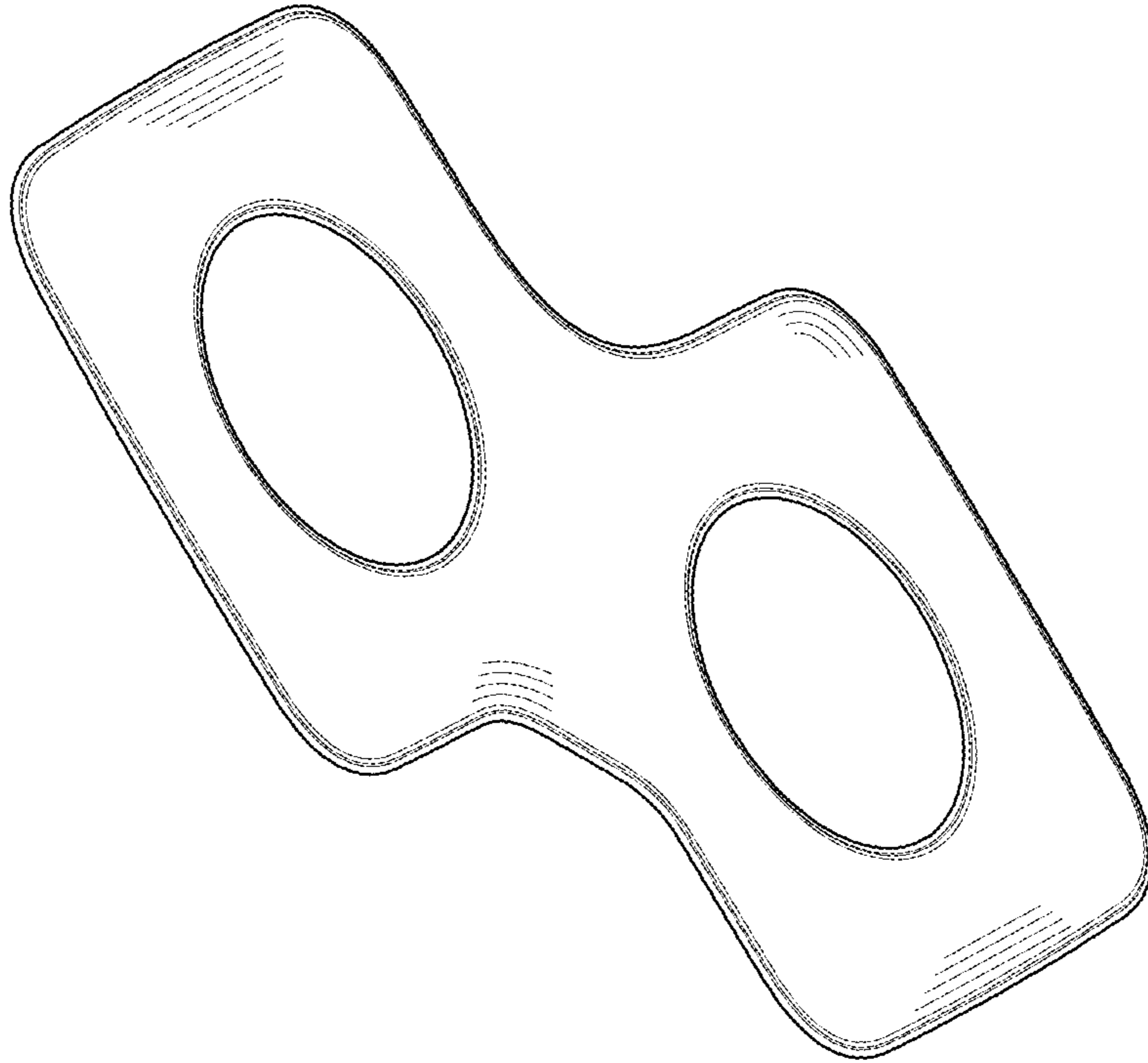

FIG.24

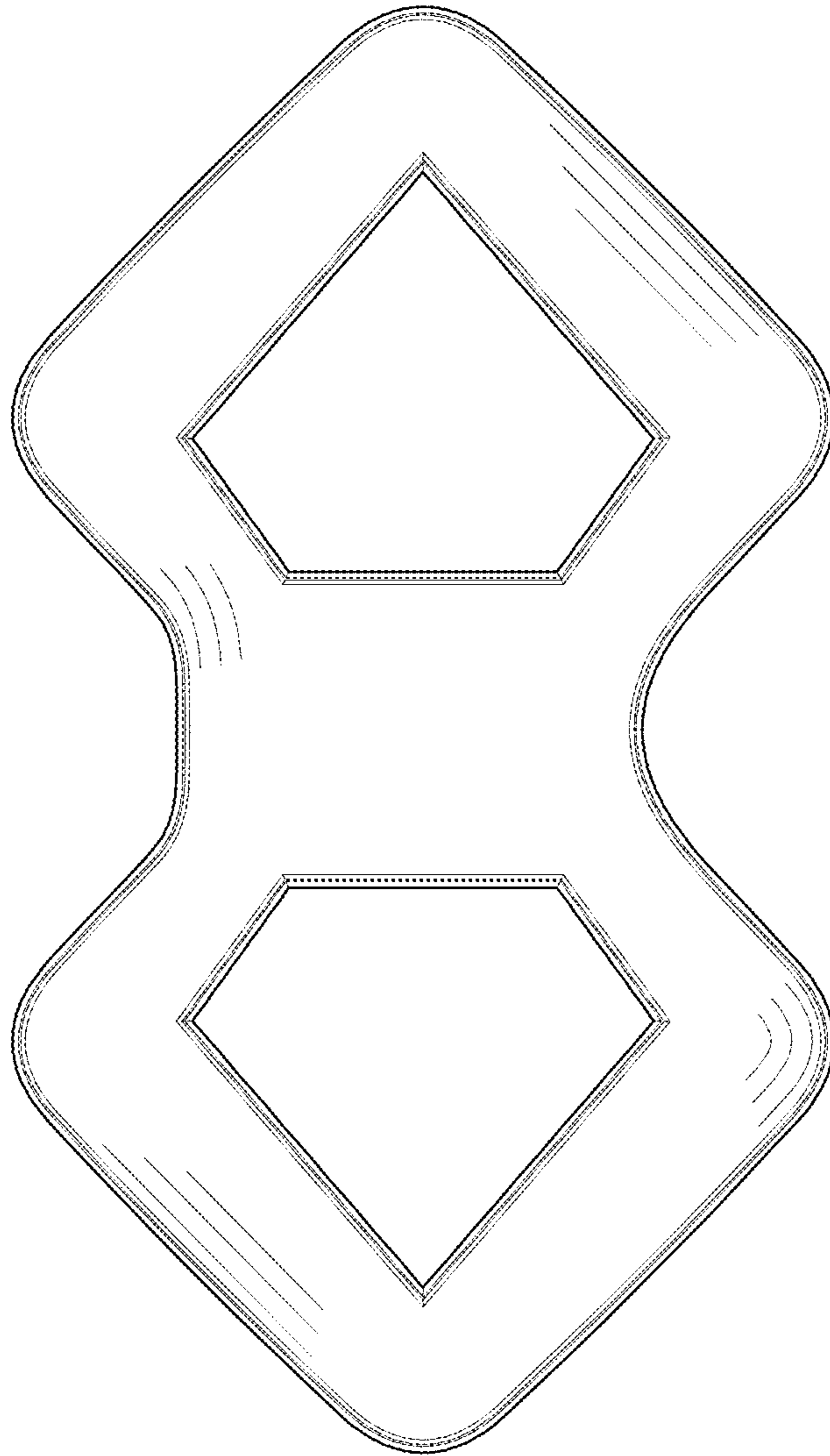

FIG.25

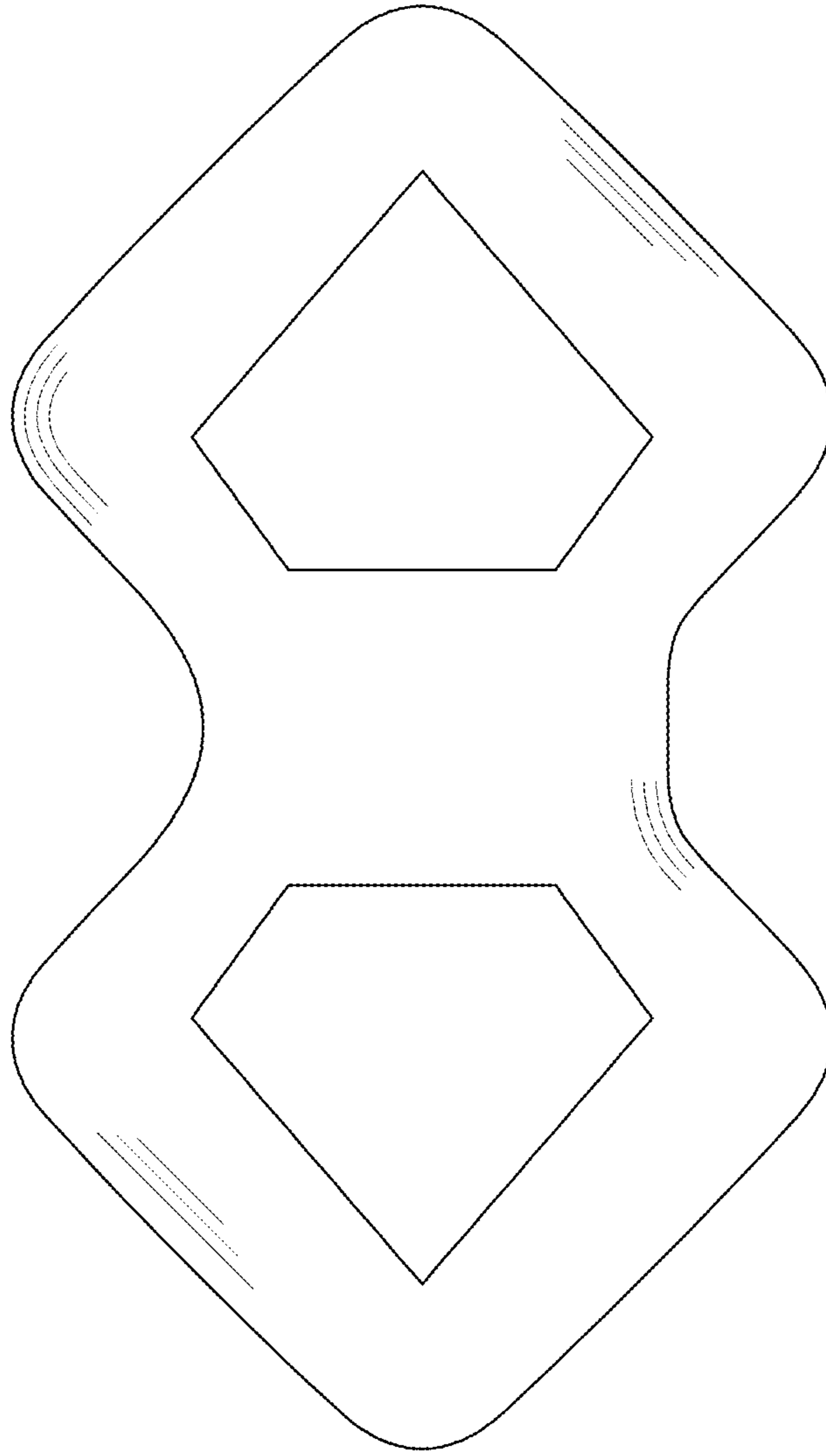

FIG.26



FIG.27

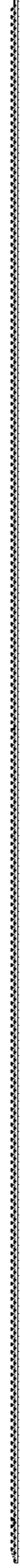

FIG.28



FIG.29

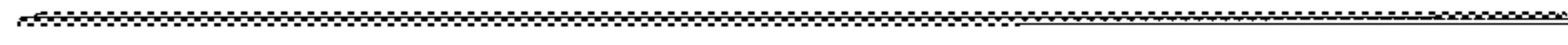

FIG.30

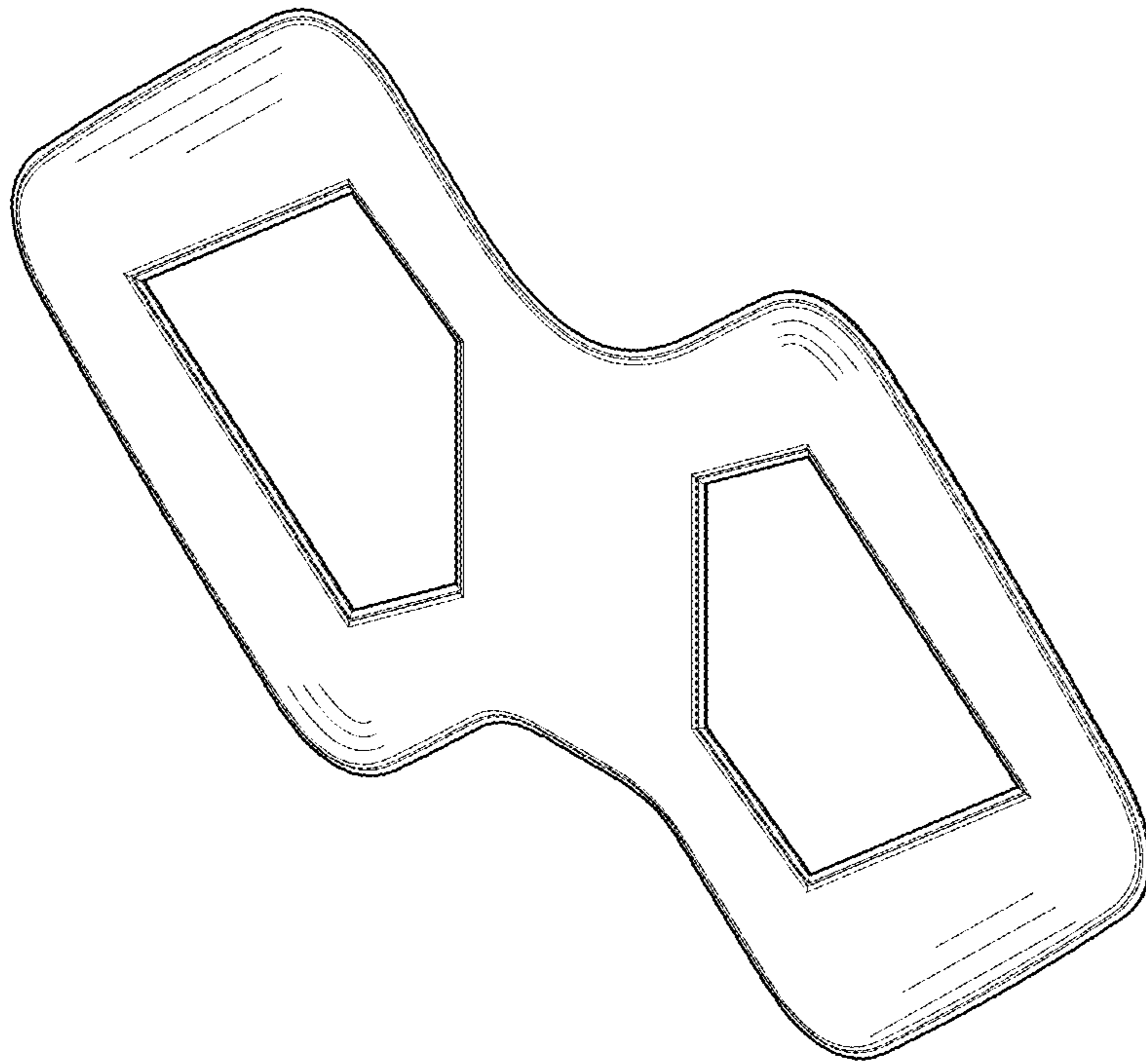

FIG.31

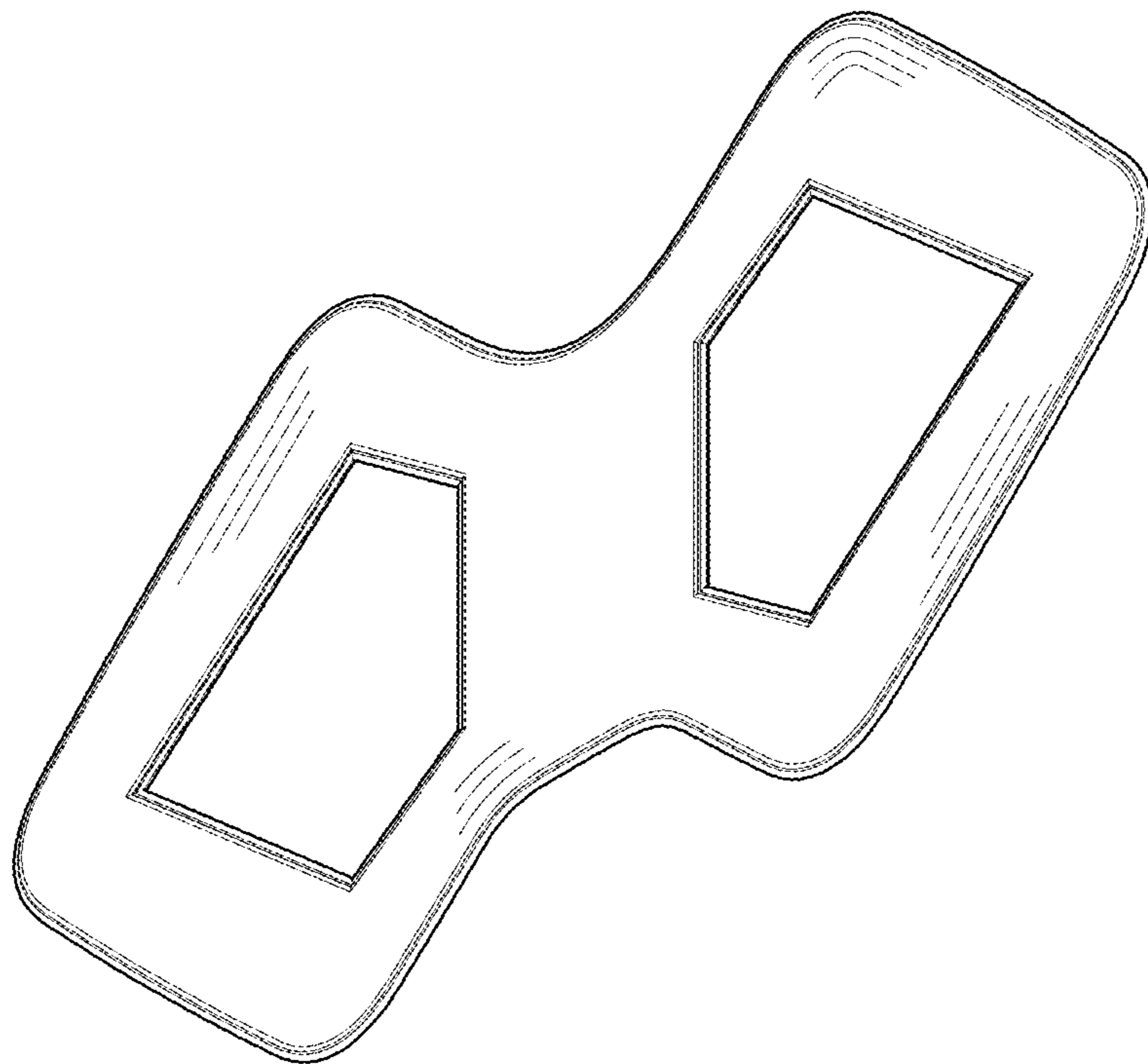

FIG.32