



US00D956650S

(12) **United States Design Patent** (10) **Patent No.:** **US D956,650 S**  
**Bae et al.** (45) **Date of Patent:** **\*\* Jul. 5, 2022**

(54) **FRONT DOOR PANEL FOR VEHICLES**  
(71) Applicants: **HYUNDAI MOTOR COMPANY**,  
Seoul (KR); **KIA MOTORS**  
**CORPORATION**, Seoul (KR)  
(72) Inventors: **Dong-Min Bae**, Suwon-si (KR);  
**Se-Bok Cheon**, Suwon-si (KR)  
(73) Assignees: **Hyundai Motor Company**, Seoul  
(KR); **Kia Motors Corporation**, Seoul  
(KR)  
(\*\*) Term: **15 Years**

D636,317 S \* 4/2011 Matei ..... D12/196  
D695,663 S \* 12/2013 Suga ..... D12/196  
D706,190 S \* 6/2014 Sakae ..... D12/196  
D775,567 S \* 1/2017 Faghihzadeh ..... D12/196  
D786,761 S \* 5/2017 Luk ..... D12/196  
D801,246 S \* 10/2017 Lee ..... D12/196  
D823,766 S \* 7/2018 Han ..... D12/196  
D827,534 S \* 9/2018 Simm ..... D12/196  
D834,481 S \* 11/2018 Lim ..... D12/196  
D840,307 S \* 2/2019 Chan ..... D12/196  
D848,334 S \* 5/2019 Tomasson ..... D12/196  
D860,895 S \* 9/2019 Lee ..... D12/196  
D863,170 S \* 10/2019 Zipfel ..... D12/196  
D867,951 S \* 11/2019 Iazard ..... D12/196  
D873,752 S \* 1/2020 Choi ..... D12/196  
D890,057 S \* 7/2020 Lim ..... D12/196

(Continued)

(21) Appl. No.: **35/511,273**

(22) Filed: **Jan. 11, 2021**

(80) **Hague Agreement Data**

Int. Filing Date: **Jan. 11, 2021**  
Int. Reg. No.: **DM/212280**  
Int. Reg. Date: **Jan. 11, 2021**  
Int. Reg. Pub. Date: **Jan. 29, 2021**

(30) **Foreign Application Priority Data**

Aug. 18, 2020 (KR) ..... 30-2020-0038604

(51) **LOC (13) Cl.** ..... **12-16**

(52) **U.S. Cl.**  
USPC ..... **D12/196**

(58) **Field of Classification Search**

USPC ..... D12/90, 91, 92, 184, 196  
CPC ..... B62D 24/00; B62D 24/02; B62D 25/02;  
B62D 25/18; B62D 25/08; B62D 35/00;  
B60J 5/04; B60R 19/02; B60R 19/04  
See application file for complete search history.

(56) **References Cited**

**U.S. PATENT DOCUMENTS**

D556,111 S \* 11/2007 Levy ..... D12/196  
D580,332 S \* 11/2008 Gueler ..... D12/196

**OTHER PUBLICATIONS**

“Hyundai—2022 Tucson.” Hyundai., Apr. 13, 2021 [online], [retrieved on Nov. 29, 2021]. Retrieved from the Internet <URL: <https://cdn.dealereprocess.org/cdn/brochures/hyundai/2022-tucson.pdf>>.\*

(Continued)

*Primary Examiner* — Darlington Ly

(74) *Attorney, Agent, or Firm* — Fox Rothschild LLP

(57) **CLAIM**

The ornamental design for a front door panel for vehicles, as shown and described.

**DESCRIPTION**

1. Front door panel for vehicles
- 1.1 is a front perspective view of a front door panel for vehicles embodying our new design;
- 1.2 is a front elevation view thereof;
- 1.3 is a rear elevation view thereof;
- 1.4 is a left side elevation view thereof;
- 1.5 is a right side elevation view thereof;
- 1.6 is a top plan view thereof; and
- 1.7 is a bottom plan view thereof.

**1 Claim, 7 Drawing Sheets**

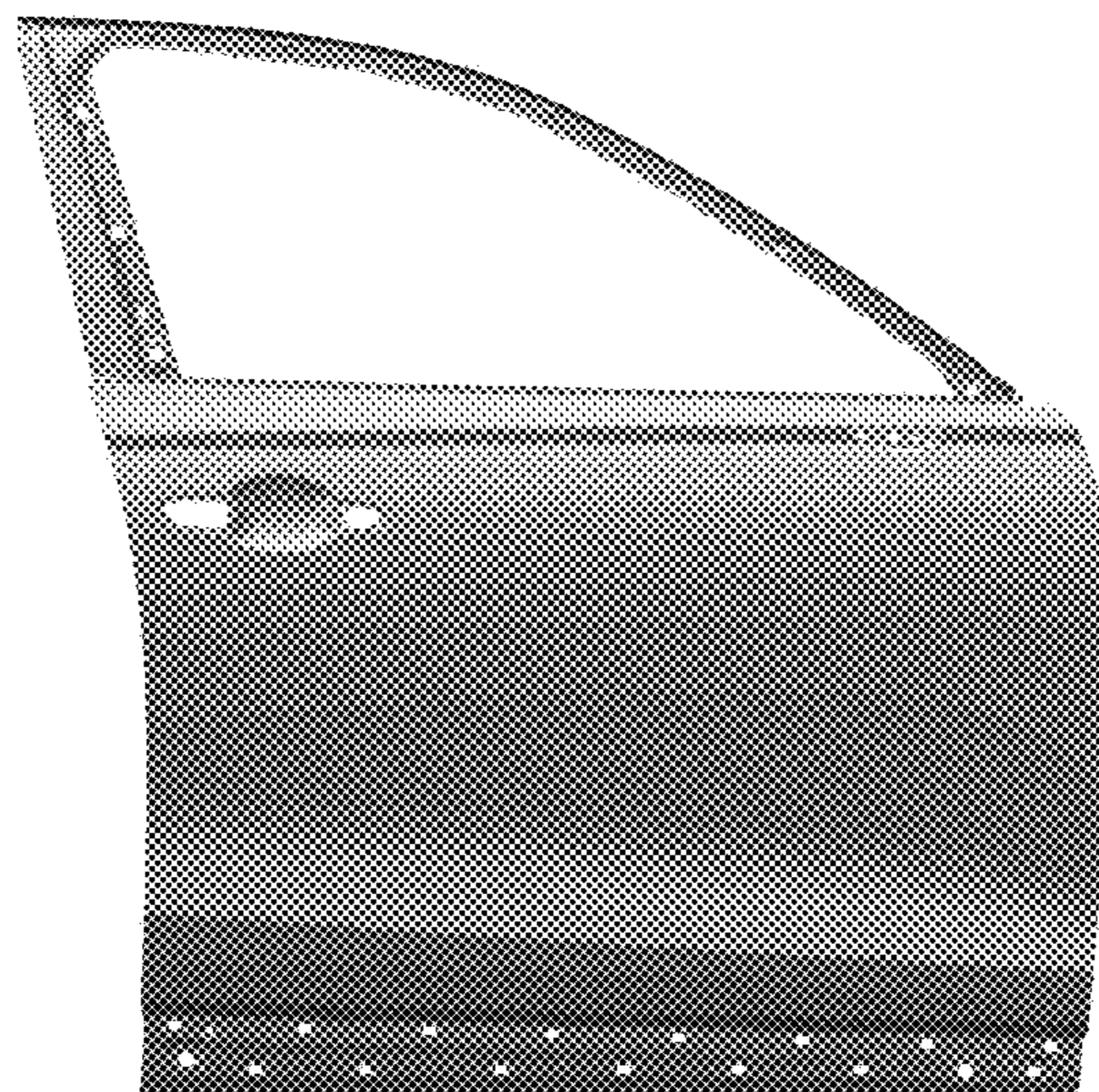

(56)

**References Cited**

U.S. PATENT DOCUMENTS

D915,973 S \* 4/2021 Kim ..... D12/196  
2011/0219700 A1\* 9/2011 Grudzinski ..... B60J 10/75  
49/493.1  
2013/0020816 A1\* 1/2013 Saitou ..... E05B 17/0012  
292/336.3  
2013/0341961 A1\* 12/2013 Mori ..... B60J 5/0402  
49/452  
2014/0132025 A1\* 5/2014 Usami ..... B60J 1/2063  
296/97.8  
2015/0035310 A1\* 2/2015 Yamaguchi ..... B60R 13/0206  
296/153  
2016/0114658 A1\* 4/2016 Yokota ..... B60J 10/45  
49/504  
2018/0051492 A1\* 2/2018 Smith ..... E05B 79/06

OTHER PUBLICATIONS

“Hyundai Tucson.” Hyundai., Jan. 21, 2021 [online], [retrieved on Nov. 29, 2021]. Retrieved from the Internet <URL: <https://www.hyundai.com/content/dam/hyundai/ww/en/images/footer/downloads/suv/e-brochure/tucson-ebrochure-2021.pdf>>.\*

“2020 Hyundai Tucson.” Hyundai., Aug. 2, 2019 [online], [retrieved on Nov. 29, 2021]. Retrieved from the Internet <URL: <https://cdn.dealereprocess.org/cdn/brochures/hyundai/2020-tucson.pdf>>.\*

\* cited by examiner

1.1

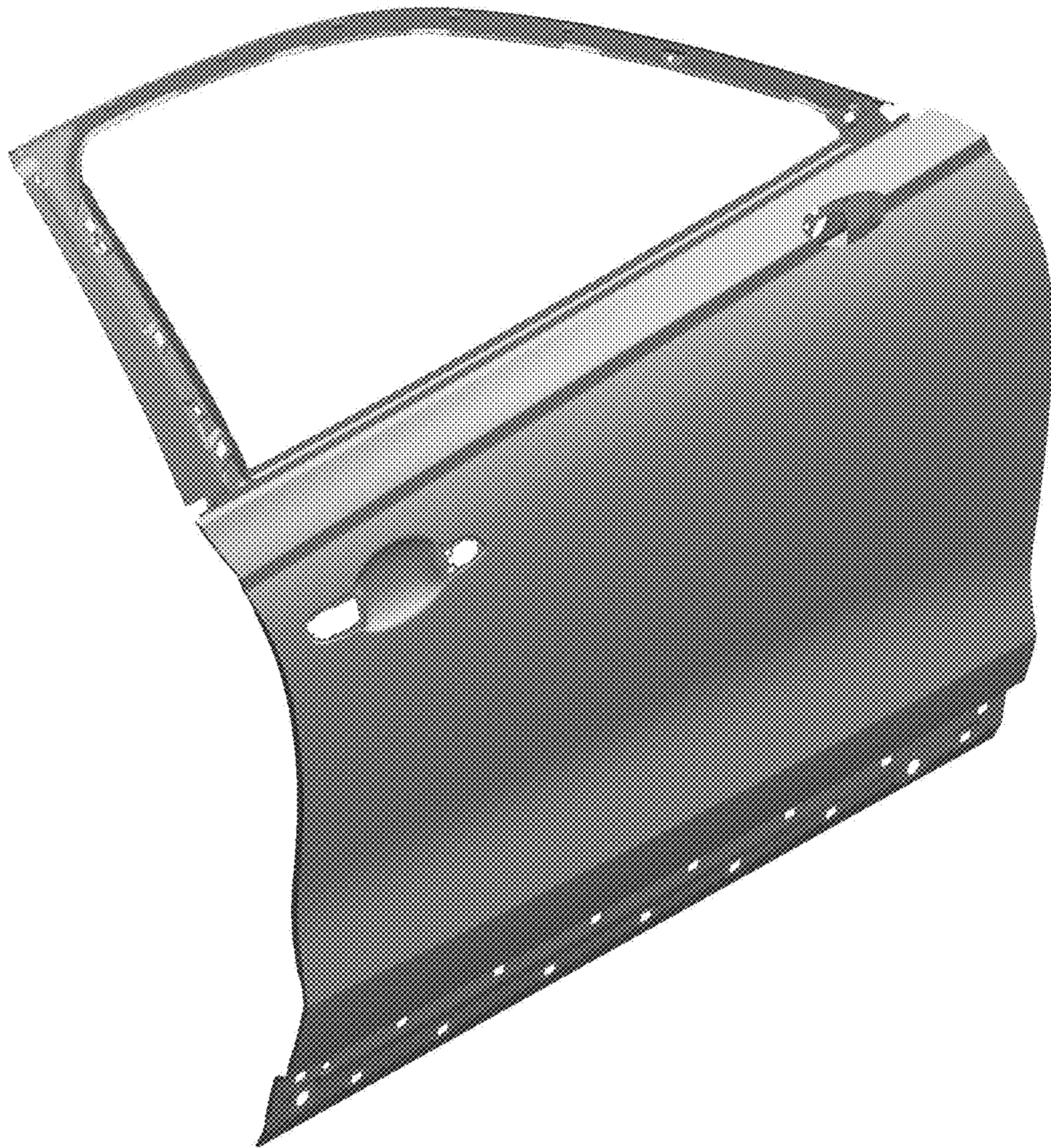

1.2

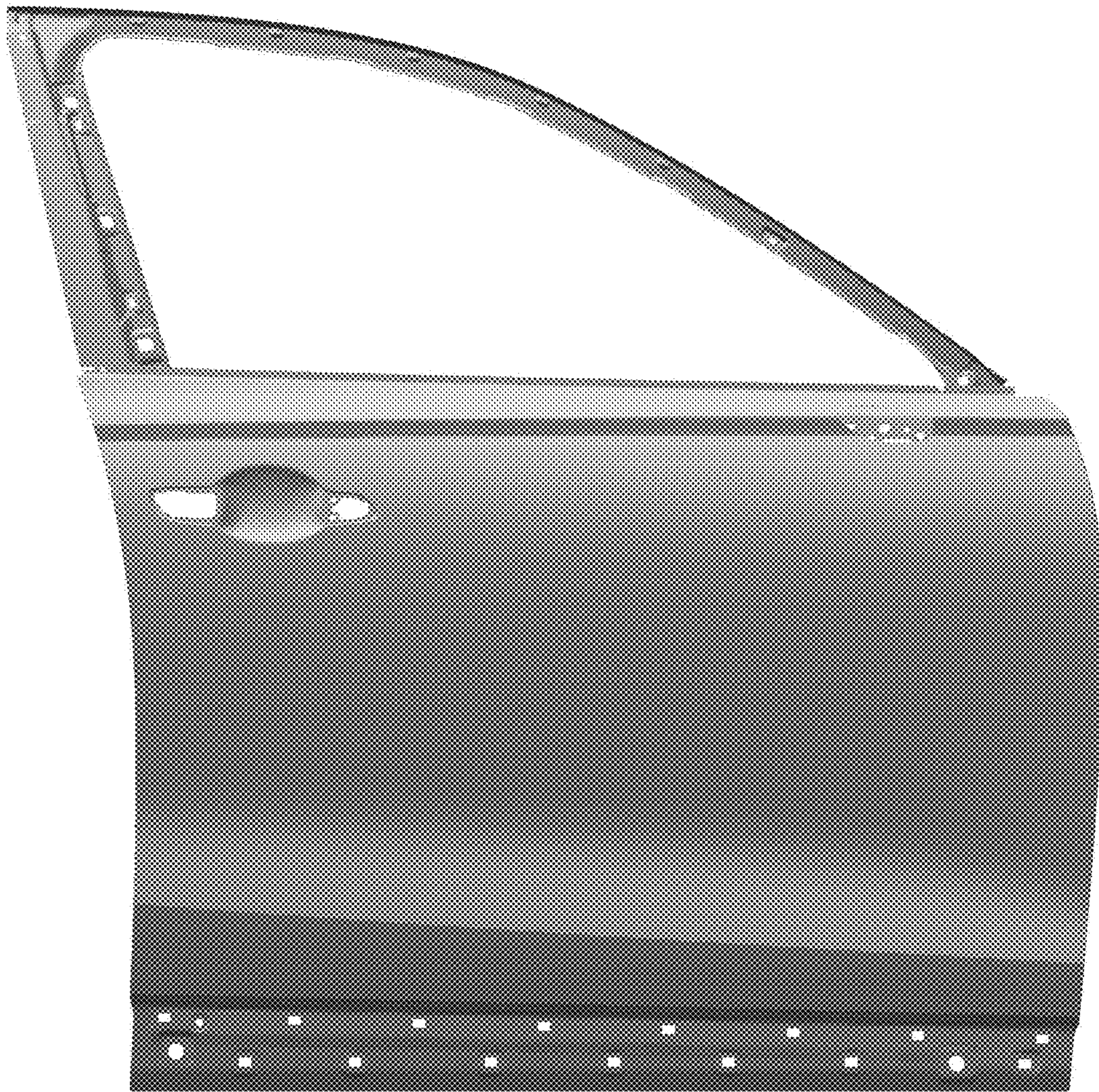

1.3

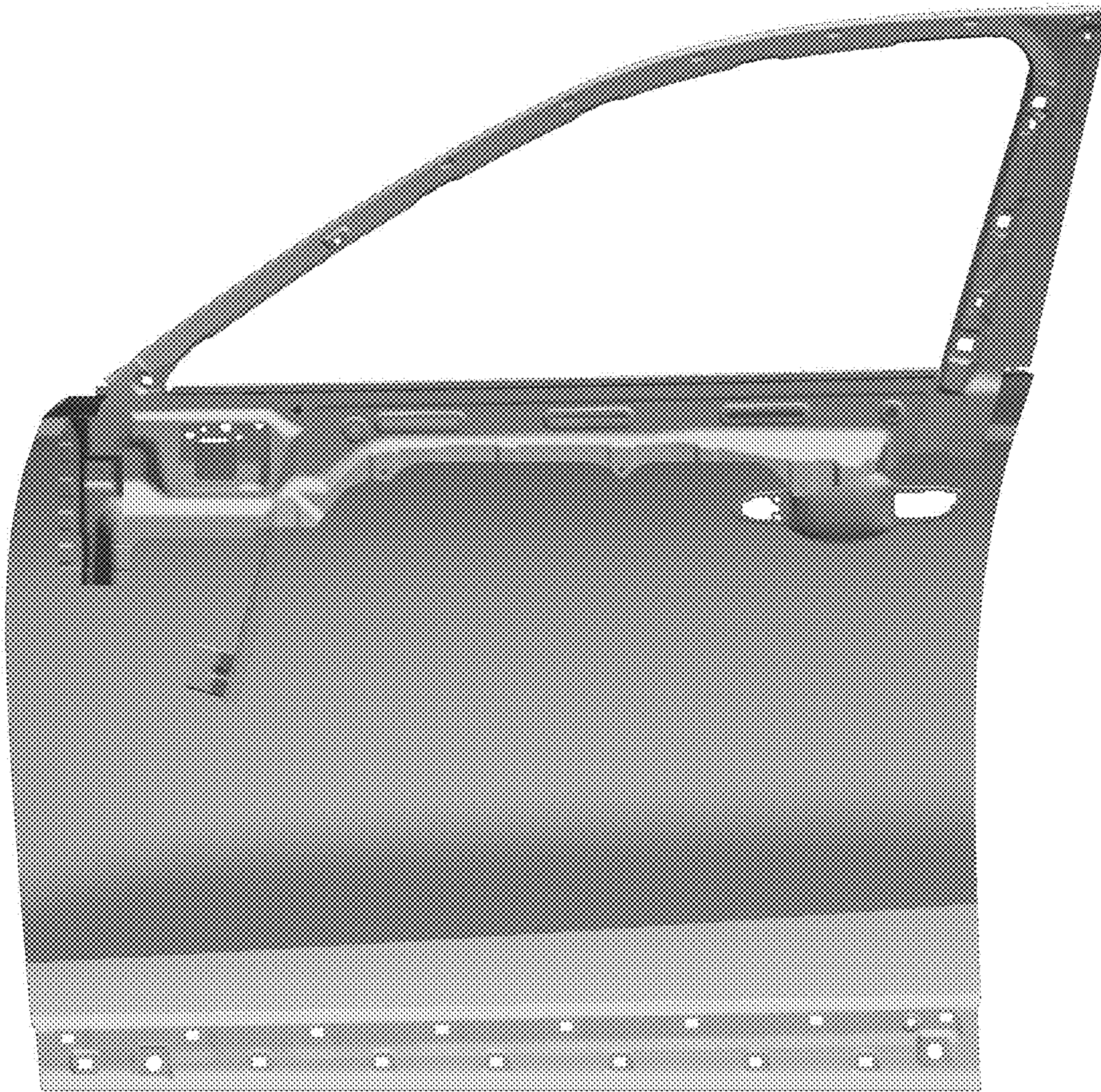

1.4

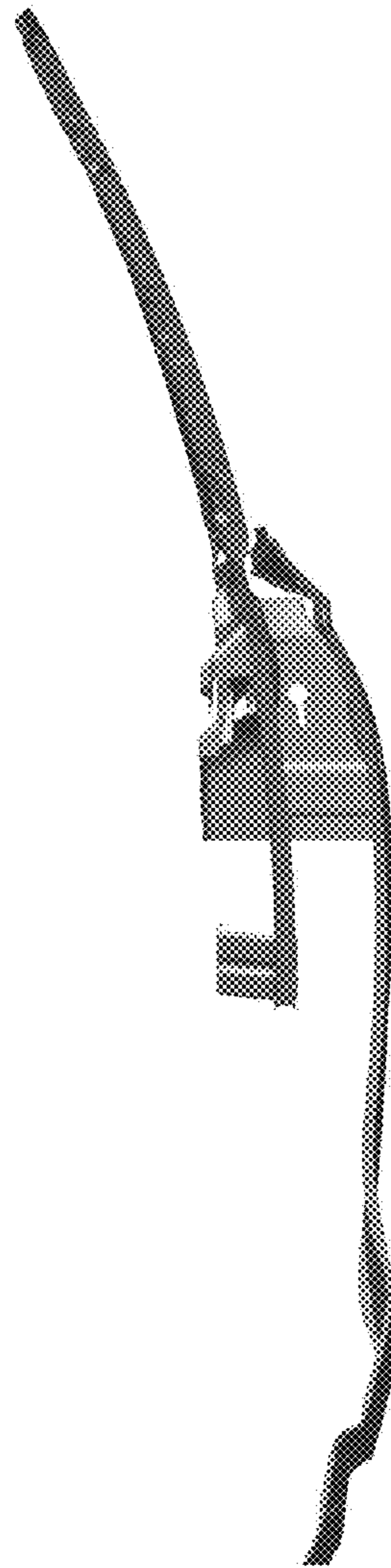

1.5

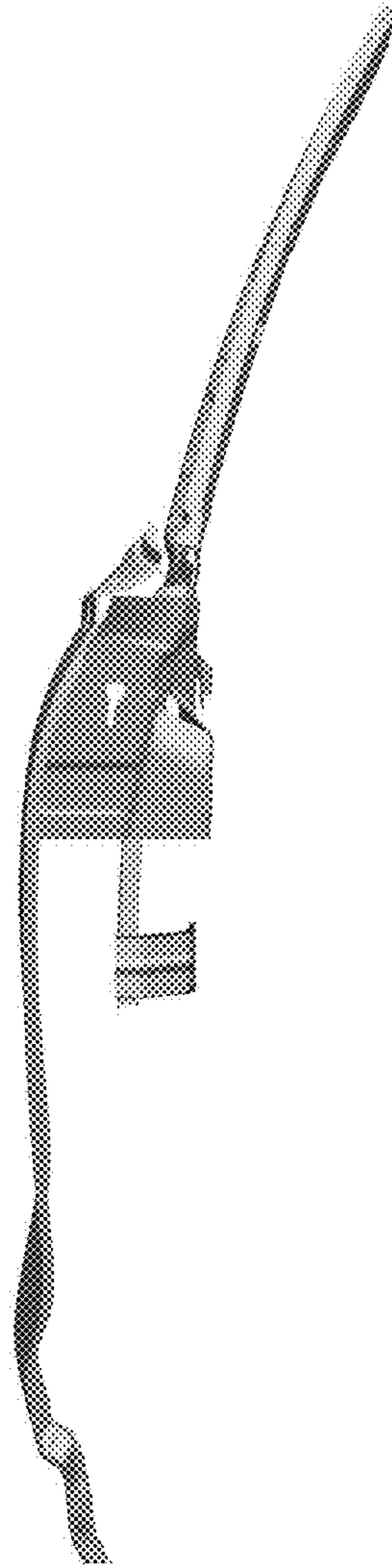

1.6

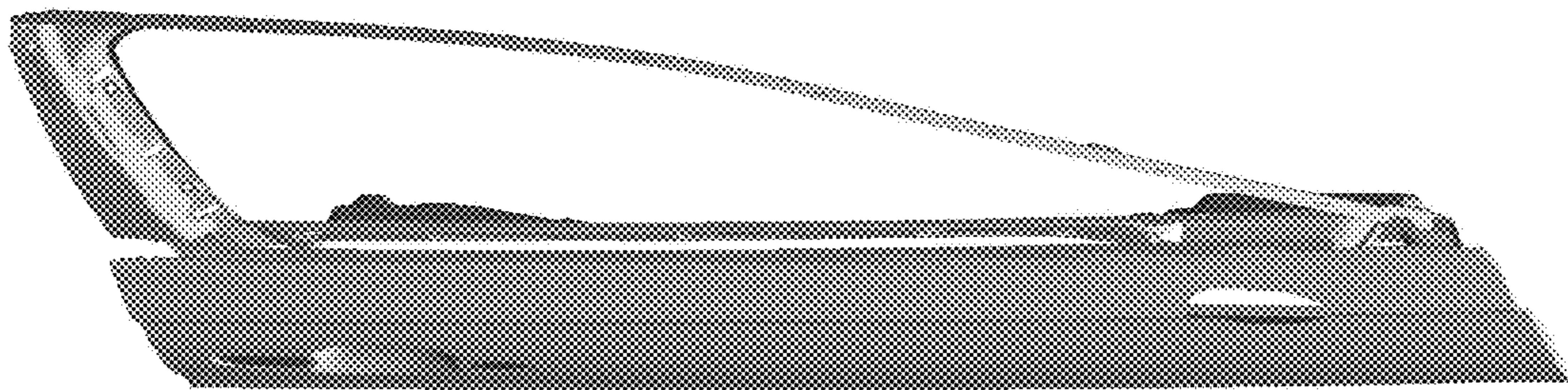



1.7

